

0603L Series

Surface Mount



Description

The 0603L Series PTC provides surface mount overcurrent protection for applications where space is at a premium and resettable protection is desired.

Features

- RoHS compliant, lead-free and halogen free
- Fast response to fault currents
- Compact design saves board space
- Low resistance
- Low-profile
- Compatible with high temperature solders

Applications

- USB peripherals
- Disk drives
- CD-ROMs
- Plug and play protection for motherboards and peripherals
- PDAs / digital cameras
- Game console port protection

Additional Information



Resources



Accessories



Samples

Agency Approvals

Agency	Agency File Number
	E183209
	R50119118

Electrical Characteristics

Part Number	Marking	I_{hold} (A)	I_{trip} (A)	V_{max} (Vdc)	I_{max} (A)	P_d typ. (W)	Maximum Time To Trip		Resistance		Agency Approvals	
							Current (A)	Time (Sec.)	R_{min} (Ω)	R_{1max} (Ω)		
0603L001/60	•	0.01	0.05	60	40	0.5	0.20	1.00	15.00	100.00	X	X
0603L002/60	2	0.02	0.06	60	40	0.5	0.20	1.00	12.00	70.00	X	X
0603L003/36	▲	0.03	0.09	36	40	0.5	0.20	1.00	6.00	50.00	X	X
0603L004	-	0.04	0.12	24	20	0.5	0.20	1.00	4.00	40.00	X	X
0603L010	C	0.10	0.30	15	40	0.5	0.50	1.00	0.900	6.000	X	X
0603L020	H	0.20	0.50	9	40	0.5	1.00	0.60	0.550	3.500	X	X
0603L025	I	0.25	0.55	9	40	0.5	8.00	0.08	0.500	3.000	X	X
0603L035	F	0.35	0.75	6	40	0.5	8.00	0.10	0.200	1.000	X	X
0603L050	J	0.50	1.00	6	40	0.5	8.00	0.10	0.100	0.680	X	X

I_{hold} = Hold current: maximum current device will pass without tripping in 20°C still air.

I_{trip} = Trip current: minimum current at which the device will trip in 20°C still air.

V_{max} = Maximum voltage device can withstand without damage at rated current (I_{max})

I_{max} = Maximum fault current device can withstand without damage at rated voltage (V_{max})

P_d = Power dissipated from device when in the tripped state at 20°C still air.

R_{min} = Minimum resistance of device in initial (un-soldered) state.

R_{1max} = Maximum resistance of device at 20°C measured one hour after tripping or reflow soldering of 260°C for 20 sec.

Caution: Operation beyond the specified rating may result in damage and possible arcing and flame.

0603L Series

Surface Mount

Temperature Derating

Part Number	Ambient Operation Temperature								
	-40°C	-20°C	0°C	20°C	40°C	50°C	60°C	70°C	85°C
0603L001/60	0.0156	0.0138	0.0121	0.010	0.0085	0.0076	0.0067	0.0058	0.0045
0603L002/60	0.0299	0.0268	0.0236	0.020	0.0173	0.0157	0.0142	0.0126	0.0102
0603L003/36	0.0454	0.0405	0.0356	0.030	0.0258	0.0234	0.0209	0.0185	0.0148
0603L004	0.052	0.048	0.044	0.040	0.032	0.028	0.024	0.020	0.012
0603L010	0.13	0.12	0.11	0.10	0.08	0.07	0.06	0.05	0.03
0603L020	0.27	0.25	0.23	0.20	0.17	0.14	0.12	0.10	0.07
0603L025	0.32	0.29	0.27	0.25	0.21	0.18	0.16	0.14	0.10
0603L035	0.47	0.41	0.38	0.35	0.29	0.26	0.24	0.20	0.14
0603L050	0.67	0.59	0.54	0.50	0.41	0.37	0.34	0.29	0.20

Average Time Current Curves

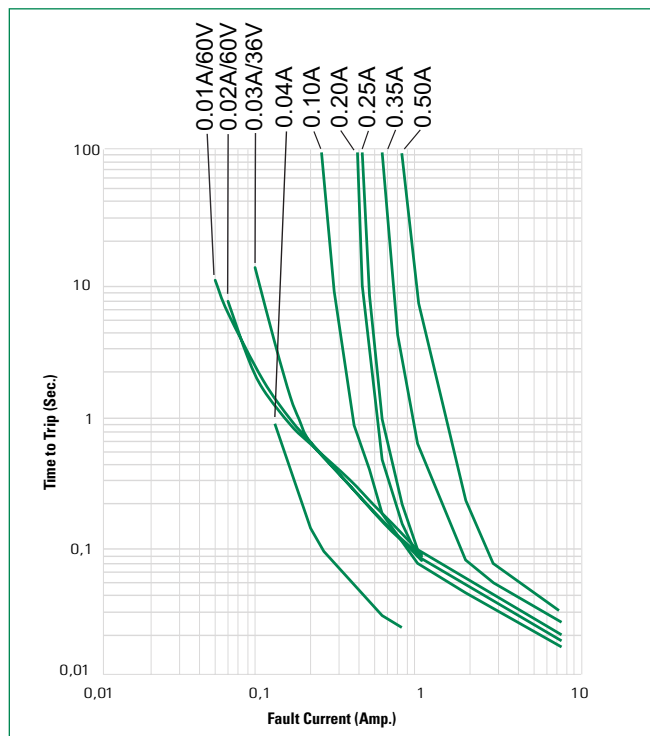

The average time current curves and Temperature Derating curve performance is affected by a number of variables, and these curves provided as guidance only. Customer must verify the performance in their application.

Temperature Derating Curve

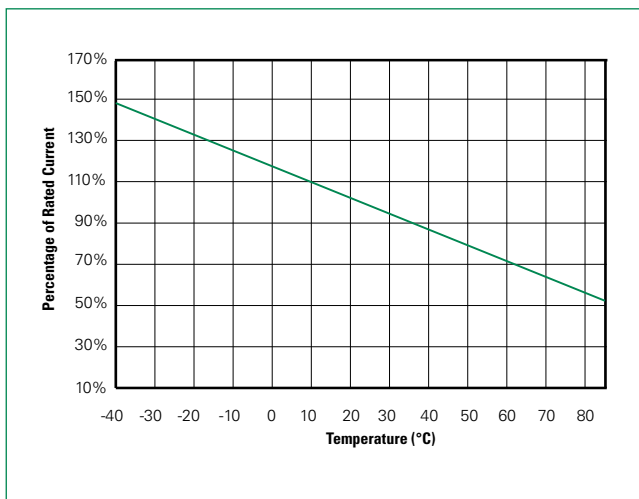

Note:
Typical Temperature derating curve, refer to table for derating data

0603L Series

Surface Mount

Soldering Parameters

Profile Feature	Pb-Free Assembly	
Average Ramp-Up Rate ($T_{S(max)}$ to T_p)	3°C/second max	
Pre Heat:	Temperature Min ($T_{S(min)}$)	150°C
	Temperature Max ($T_{S(max)}$)	200°C
	Time (Min to Max) (t_s)	60 – 180 secs
Time Maintained Above:	Temperature (T_L)	217°C
	Temperature (t_L)	60 – 150 seconds
Peak / Classification Temperature (T_p)	260 ^{+0/-5} °C	
Time within 5°C of actual peak Temperature (t_p)	20 – 40 seconds	
Ramp-down Rate	6°C/second max	
Time 25°C to peak Temperature (T_p)	8 minutes Max.	

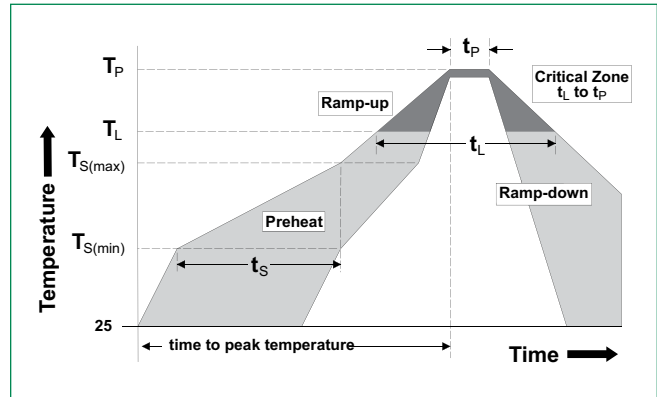

Physical Specifications

Terminal Material	Solder-Plated Copper (Solder Material: Matte Tin (Sn))
Lead Solderability	Meets EIA Specification RS186-9E, ANSI/J-STD-002, Category 3.

Environmental Specifications

Operating Temperature	-40°C to +85°C
Maximum Device Surface Temperature in Tripped State	125°C
Passive Aging	+85°C, 1000 hours -/+10% typical resistance change
Humidity Aging	+85°C, 85% R.H., 100 hours -/+15% typical resistance change
Thermal Shock	MIL-STD-202, Method 107 +85°C/-40°C 20 times -30% typical resistance change
Solvent Resistance	MIL-STD-202, Method 215 No change
Vibration	MIL-STD-883, Method 2007, Condition A No change
Moisture Sensitivity Level	Level 1, J-STD-020

0603L Series

Surface Mount

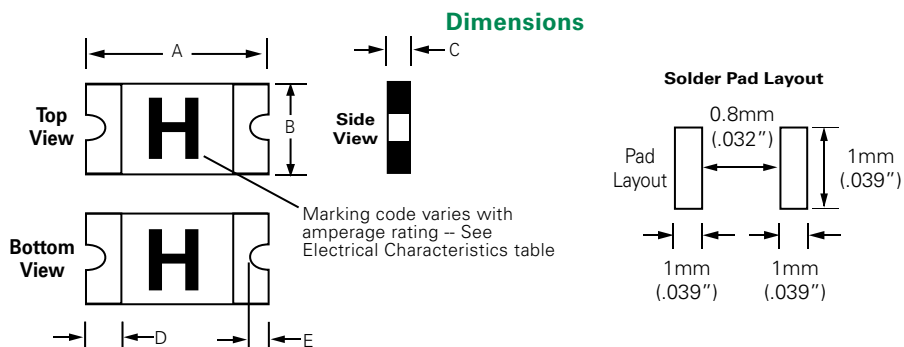

Part Number	A		B		C		D		E											
	Min	Max	Min	Max	Min	Max	Min	Max	Min	Max										
	Inch	mm	Inch	mm	Inch	mm	Inch	mm	Inch	mm										
0603L001/60	.055	.071	1.40	1.80	.024	.039	0.60	1.00	.016	.039	0.40	1.00	.006	.020	0.15	0.50	-	.016	-	0.40
0603L002/60	.055	.071	1.40	1.80	.024	.039	0.60	1.00	.016	.039	0.40	1.00	.006	.020	0.15	0.50	-	.016	-	0.40
0603L003/36	.055	.071	1.40	1.80	.024	.039	0.60	1.00	.016	.039	0.40	1.00	.006	.020	0.15	0.50	-	.016	-	0.40
0603L004	.055	.071	1.40	1.80	.024	.039	0.60	1.00	.016	.030	0.40	0.75	.006	.020	0.15	0.50	.004	.016	0.10	0.40
0603L010	.055	.071	1.40	1.80	.024	.039	0.60	1.00	.016	.030	0.40	0.75	.006	.020	0.15	0.50	.004	.016	0.10	0.40
0603L020	.055	.071	1.40	1.80	.024	.039	0.60	1.00	.016	.030	0.40	0.75	.006	.020	0.15	0.50	.004	.016	0.10	0.40
0603L025	.055	.071	1.40	1.80	.024	.039	0.60	1.00	.016	.030	0.40	0.75	.006	.020	0.15	0.50	.004	.016	0.10	0.40
0603L035	.055	.071	1.40	1.80	.024	.039	0.60	1.00	.030	.061	0.75	1.55	.006	.020	0.15	0.50	.004	.016	0.10	0.40
0603L050	.055	.071	1.40	1.80	.024	.039	0.60	1.00	.030	.061	0.75	1.55	.006	.020	0.15	0.50	.004	.016	0.10	0.40

Part Ordering Number System

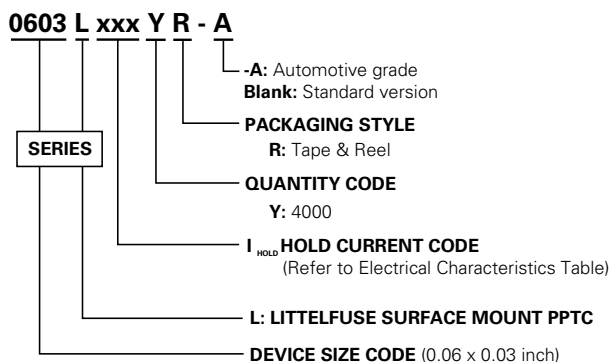

Packaging

Part Number	Ordering Number	Halogen Free	I _{hold} (A)	I _{hold} Code	Packaging Option	Quantity	Quantity & Packaging Codes
0603L001/60	0603L001/60YR	Yes	0.01	001	Tape and Reel	4000	YR
0603L002/60	0603L002/60YR	Yes	0.02	002	Tape and Reel	4000	YR
0603L003/36	0603L003/36YR	Yes	0.03	003	Tape and Reel	4000	YR
0603L004	0603L004YR	Yes	0.04	004	Tape and Reel	4000	YR
0603L010	0603L010YR	Yes	0.10	010	Tape and Reel	4000	YR
0603L020	0603L020YR	Yes	0.20	020	Tape and Reel	4000	YR
0603L025	0603L025YR	Yes	0.25	025	Tape and Reel	4000	YR
0603L035	0603L035YR	Yes	0.35	035	Tape and Reel	4000	YR
0603L050	0603L050YR	Yes	0.50	050	Tape and Reel	4000	YR

0603L Series

Surface Mount

Tape and Reel Specifications

TAPE SPECIFICATIONS: EIA-481-1 (mm)		
	0603L004 0603L010 0603L020 0603L025	0603L001/60 0603L002/60 0603L003/36 0603L035 0603L050
W	8.0+/- 0.30	8.0+/- 0.30
F	3.5+/- 0.05	3.5+/- 0.05
E₁	1.75+/- 0.10	1.75+/- 0.10
D₀	1.55+/- 0.05	1.55+/- 0.05
T	0.20+/- 0.10	0.20+/- 0.10
K₀	0.72+/- 0.10	0.96+/- 0.10
Leader min.	390	390
Trailer min.	160	160

REEL DIMENSIONS: EIA-481-1 (mm)	
C	Ø178+/-1.0
D	Ø60.2+/- 0.5
H	11.0+0.5
W	9.0+/- 1.5

Tape and Reel Diagram

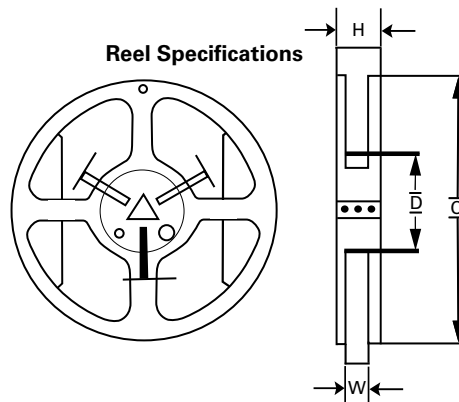
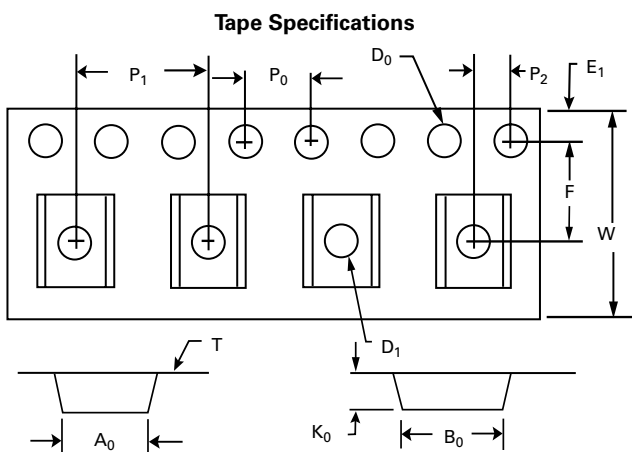

Warning

- Users should independently evaluate the suitability of and test each product selected for their own application.
- Operation beyond the maximum ratings or improper use may result in device damage and possible electrical arcing and flame.
- These devices are intended for protection against damage caused by occasional overcurrent or overtemperature fault conditions and should not be used when repeated fault conditions or prolonged trip events are anticipated.
- Contamination of the PPTC material with certain silicone-based oils or some aggressive solvents can adversely impact the performance of the devices.
- Device performance can be impacted negatively if devices are handled in a manner inconsistent with recommended electronic, thermal, and mechanical procedures for electronic components.
- PPTC devices are not recommended for installation in applications where the device is constrained such that its PTC properties are inhibited, for example in rigid potting materials or in rigid housings, which lack adequate clearance to accommodate device expansion.
- Operation in circuits with a large inductance can generate a circuit voltage (Ldi/dt) above the rated voltage of the device.

Disclaimer Notice - Information furnished is believed to be accurate and reliable. However, users should independently evaluate the suitability of and test each product selected for their own applications. Littelfuse products are not designed for, and may not be used in, all applications. Read complete Disclaimer Notice at www.littelfuse.com/disclaimer-electronics.