

DST5100S-A

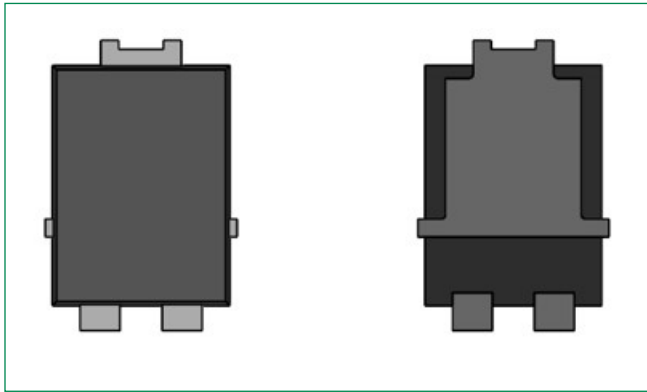

Features

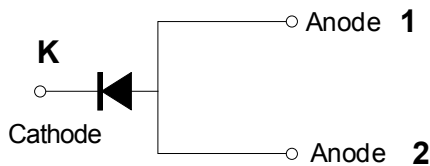

Description

Littelfuse DST series Ultra Low V_F Schottky Barrier Rectifier is designed to meet the general requirements of automotive applications by providing high temperature, low leakage and low V_F products.

It is suitable for high frequency switching mode power supply applications, as free-wheeling and polarity protection diodes.

Features

- High reliability application and AEC-Q101 qualified
- Ultra low forward voltage drop
- High frequency operation
- MSL: Level 1 - unlimited
- High junction temperature capability
- Trench MOS Barrier Schottky technology
- Single die in TO-277B Package
- Pb-free E3 means 2nd level interconnect is Pb-free and the terminal finish material is tin(Sn) (IPC/ JEDEC J-STD-609A.01)

Applications

- Switching mode power supply
- DC/DC converters
- Free-Wheeling diodes
- Polarity Protection Diodes

Maximum Ratings

Parameters	Symbol	Test Conditions	Max	Unit
Peak Inverse Voltage	V_{RWM}	-	100	V
Average Forward Current (per device) *	$I_{F(AV)}$	50% duty cycle @ $T_A = 25^\circ\text{C}$ rectangular wave form	5	A
Peak One Cycle Non-Repetitive Surge Current (per leg)	I_{FSM}	8.3 ms, half Sine pulse	120	A

* Mounted on 30 mm x 30 mm pad areas aluminum PCB

Electrical Characteristics

Parameters	Symbol	Test Conditions	Typ	Max	Unit
Forward Voltage Drop (per leg) *	V_{F1}	@5A, Pulse, $T_J = 25^\circ\text{C}$	0.69	0.75	V
	V_{F2}	@5A, Pulse, $T_J = 125^\circ\text{C}$	0.61	0.70	
Reverse Current (per leg) *	I_{R1}	@ $V_R = \text{rated } V_R, T_J = 25^\circ\text{C}$	0.06	0.12	mA
	I_{R2}	@ $V_R = \text{rated } V_R, T_J = 125^\circ\text{C}$	2	18	
Junction Capacitance (per leg)	C_T	@ $V_R = 5V, T_C = 25^\circ\text{C}, f_{SIG} = 1\text{MHz}$	245	-	pF
Voltage Rate of Change	dv/dt		-	10000	V/ μs

* Pulse Width < 300 μs , Duty Cycle < 2%

Thermal-Mechanical Specifications

Parameters	Symbol	Test Conditions	Max	Unit
Junction Temperature	T_J	-	-55 to +150	°C
Storage Temperature	T_{stg}	-	-55 to +150	°C
Maximum Thermal Resistance Junction to Ambient	$R_{\theta JA}$	DC operation	75	°C/W
Maximum Thermal Resistance Junction to Lead	$R_{\theta JL}^*$		4	°C/W
Approximate Weight	wt	-	0.08	g
Case Style	TO-277B			

*Lead temperature monitored at the cathode pin

Figure 1: Forward Current Derating Curve

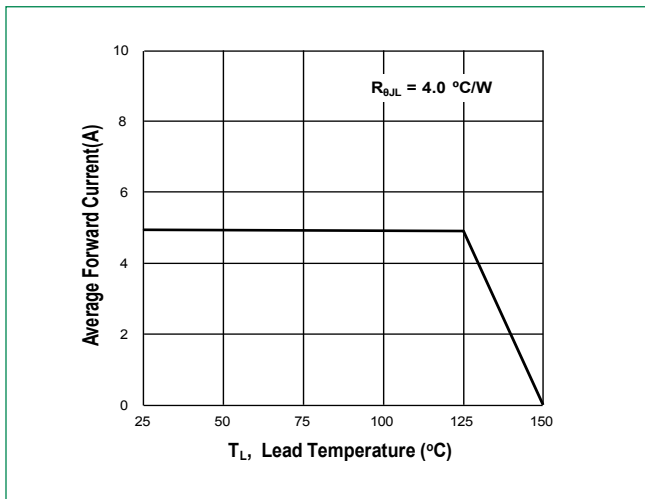

Figure 2: Forward Power Loss Characteristics

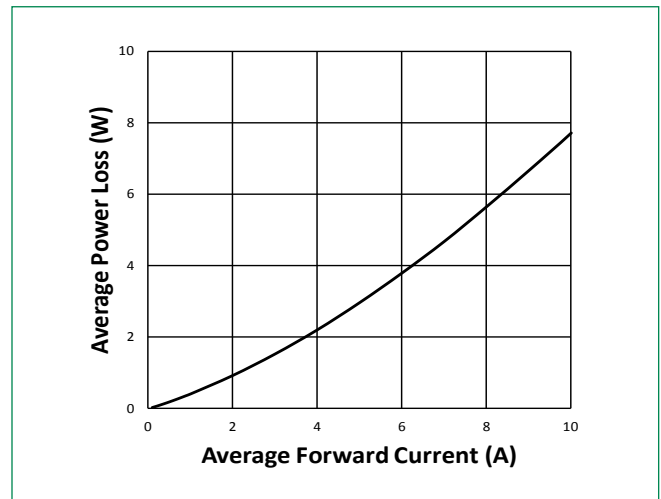

Figure 3: Typical Junction Capacitance

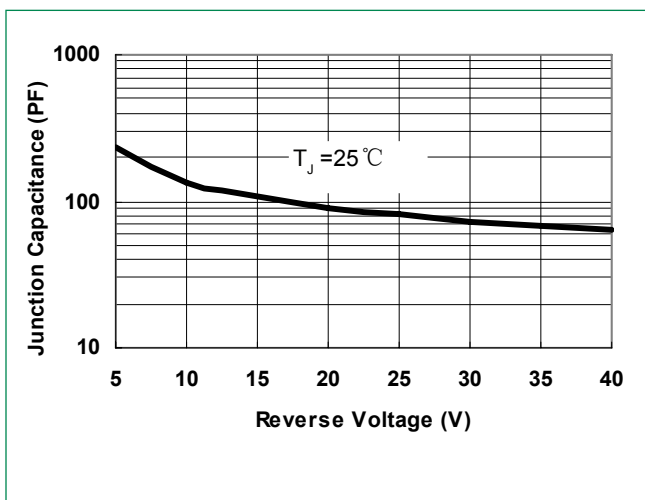

Figure 4: Typical Reverse Characteristics

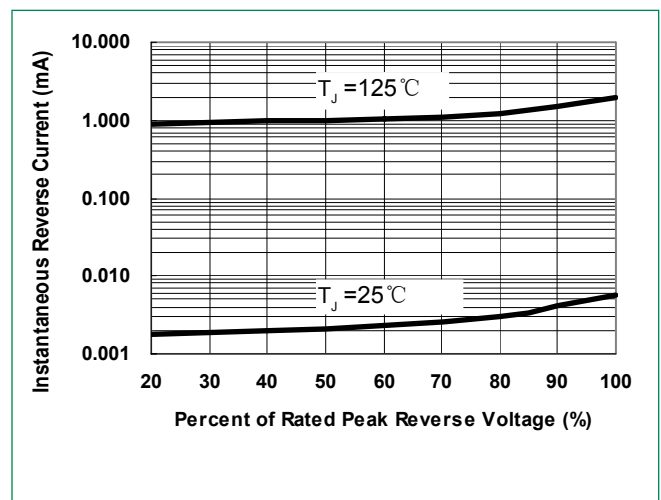
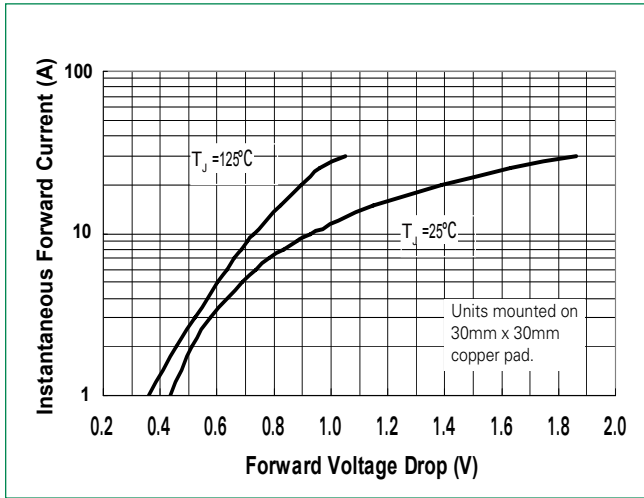
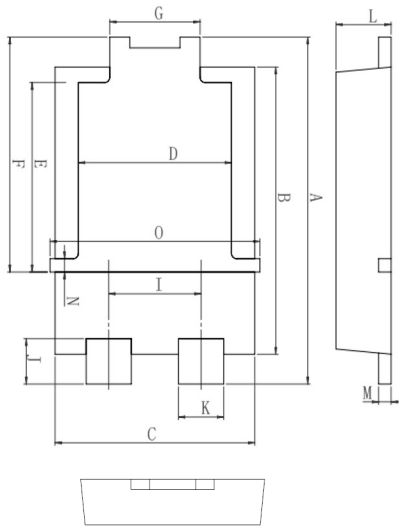

Figure 3: Typical Instantaneous Forward Voltage Characteristics



Dimensions-TO-277B



Symbol	Millimeters		
	Min	Typ	Max
A	6.30	6.50	6.70
B	5.28	5.38	5.48
C	3.88	3.98	4.08
D	2.90	3.05	3.20
E	3.40	3.55	3.70
F	4.20	4.40	4.60
G	1.70	1.80	1.90
I	1.74	1.84	1.94
J	0.65	0.85	1.05
K	0.85	0.90	0.95
L	0.95	1.10	1.25
M	0.20	0.25	0.30
N	0.25	0.40	0.55
O	4.00	4.05	4.25

Mounting Pad Layout

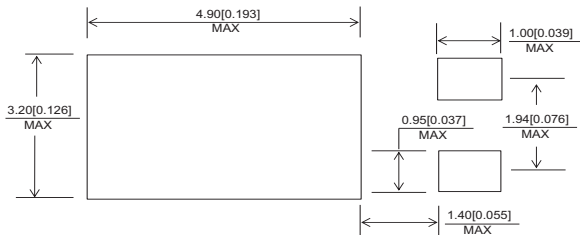

Part Numbering and Marking System

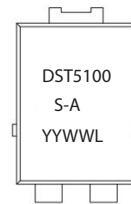

- DST = Device Type
- 5 = Forward Current (5A)
- 100 = Reverse Voltage (100V)
- S = Package Type
- A = AEC-Q101 qualified device
- YY = Year
- WW = Week
- L = Lot Number

Packing Options

Part Number	Marking	Packing Mode	M.O.Q
DST5100S-A	DST5100S-A	5000pcs / Reel	5000

Carrier Tape & Reel Specification

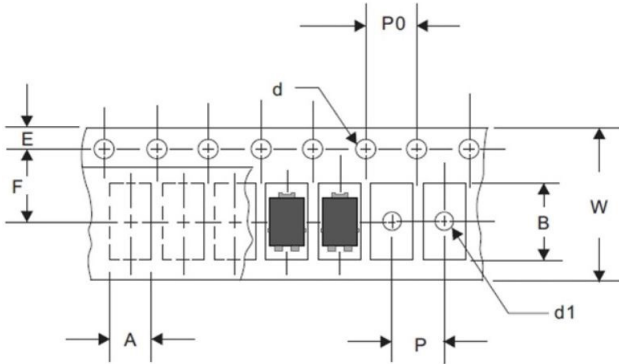

Symbol	Millimeters	
	Min	Max
A	4.28	4.48
B	6.80	7.00
d	1.40	1.60
d1	-	1.50
E	1.65	1.85
F	7.40	7.60
P	7.90	8.10
P0	3.90	4.10
W	15.70	16.30