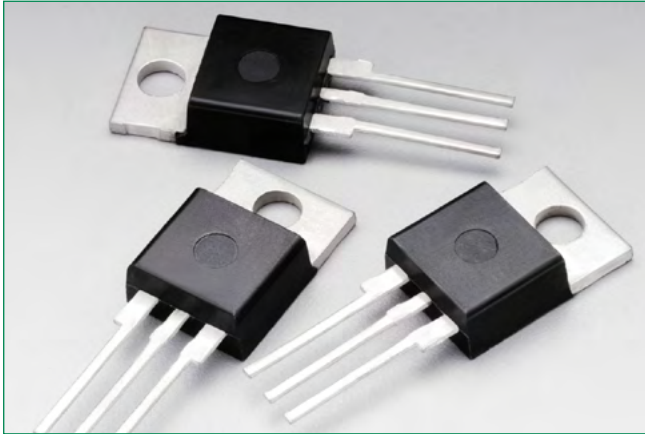

BTB12-600CW3G, BTB12-800CW3G

Surface Mount – 800V

**Description**

The BTB12 is designed for high performance full-wave AC control applications where high noise immunity and high commutating di/dt are required.

Features

- Blocking Voltage to 800 V
- On-State Current Rating of 12 Amperes RMS at 25°C
- Uniform Gate Trigger Currents in Three Quadrants
- High Immunity to dV/dt – 1500 V/μs minimum at 125°C
- Minimizes Snubber Networks for Protection
- Industry Standard TO-220AB Package
- High Commutating di/dt – 3.0. A/ms minimum at 125°C
- These are Pb-Free Devices

Additional Information

Resources



Accessories

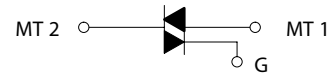
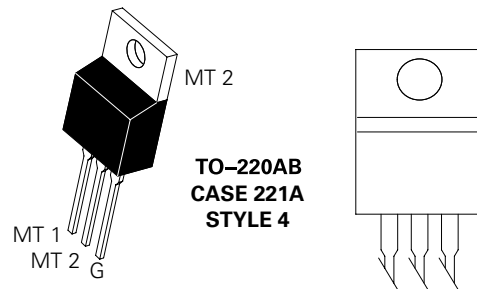

Samples

Functional Diagram**Pin Out**

BTB12-600CW3G, BTB12-800CW3G

Surface Mount – 800V

Maximum Ratings ($T_J = 25^\circ\text{C}$ unless otherwise noted)

| Rating | Symbol | Value | Unit |
|---|------------------------|-------------------------|--------------------|
| Peak Repetitive Off-State Voltage (Note 1) (Gate Open, Sine Wave 50 to 60 Hz, $T_J = -40^\circ$ to 125°C) | V_{DRM} V_{RRM} | 600 800 | V |
| On-State RMS Current (Full Cycle Sine Wave, 60 Hz, $T_C = 80^\circ\text{C}$) | $I_{T(RMS)}$ | 12 | A |
| Peak Non-Repetitive Surge Current (One Full Cycle Sine Wave, 60 Hz, $T_C = 25^\circ\text{C}$) | I_{TSM} | 120 | A |
| Circuit Fusing Consideration ($t = 10$ ms) | I^2t | 78 | A ² sec |
| Non-Repetitive Surge Peak Off-State Voltage ($T_J = 25^\circ\text{C}$, $t = 10$ ms) | V_{DSM}/V_{RSM} | $V_{DSM}/V_{RSM} + 100$ | V |
| Peak Gate Current ($T_J = 125^\circ\text{C}$, $t = 20$ ms) | I_{GM} | 4.0 | W |
| Peak Gate Power (Pulse Width ≤ 1.0 μs , $T_C = 80^\circ\text{C}$) | P_{GM} | 20 | W |
| Average Gate Power ($T_J = 125^\circ\text{C}$) | $P_{G(AV)}$ | 1.0 | W |
| Operating Junction Temperature Range | T_J | -40 to +125 | $^\circ\text{C}$ |
| Storage Temperature Range | T_{stg} | -40 to +150 | $^\circ\text{C}$ |

Stresses exceeding Maximum Ratings may damage the device. Maximum Ratings are stress ratings only. Functional operation above the Recommended Operating Conditions is not implied. Extended exposure to stresses above the Recommended Operating Conditions may affect device reliability.

1. V_{DRM} and V_{RRM} for all types can be applied on a continuous basis. Ratings apply for zero or negative gate voltage; however, positive gate voltage shall not be applied concurrent with negative potential on the anode. Blocking voltages shall not be tested with a constant current source such that the voltage ratings of the devices are exceeded.

Thermal Characteristics

| Rating | Symbol | Value | Unit | |
|--|--|------------------------------------|------------------|---------------------------|
| Thermal Resistance | Junction-to-Case (AC) Junction-to-Ambient | $R_{\theta JC}$ $R_{\theta JA}$ | 2.3 60 | $^\circ\text{C}/\text{W}$ |
| Maximum Lead Temperature for Soldering Purposes, 1/8" from case for 10 seconds | T_L | 260 | $^\circ\text{C}$ | |

Electrical Characteristics - OFF ($T_J = 25^\circ\text{C}$ unless otherwise noted ; Electricals apply in both directions)

| Characteristic | Symbol | Min | Typ | Max | Unit |
|--|------------------------|-----|-----|-------|------|
| Peak Repetitive Blocking Current ($V_D = V_{DRM} = V_{RRM}$; Gate Open) | I_{DRM} I_{RRM} | - | - | 0.005 | mA |
| | | - | - | 1.0 | |

Electrical Characteristics - ON ($T_J = 25^\circ\text{C}$ unless otherwise noted; Electricals apply in both directions)

| Characteristic | Symbol | Min | Typ | Max | Unit |
|---|--------------|-----|-----|------|------|
| Forward On-State Voltage (Note 2) ($I_{TM} = \pm 17$ A Peak) | V_{TM} | - | - | 1.55 | V |
| Gate Trigger Current (Continuous dc) ($V_D = 12$ V, $R_L = 30$ Ω) | MT2(+), G(+) | 2.0 | - | 35 | mA |
| | MT2(+), G(-) | 2.0 | - | 35 | |
| | MT2(-), G(-) | 2.0 | - | 35 | |
| Holding Current ($V_D = 12$ V, Gate Open, Initiating Current = ± 100 mA) | I_H | - | - | 45 | mA |
| Latching Current ($V_D = 12$ V, $I_G = 42$ mA) | MT2(+), G(+) | - | - | 50 | mA |
| | MT2(+), G(-) | - | - | 80 | |
| | MT2(-), G(-) | - | - | 50 | |
| Gate Trigger Voltage ($V_D = 12$ V, $R_L = 30$ Ω) | MT2(+), G(+) | 0.5 | - | 1.7 | V |
| | MT2(+), G(-) | 0.5 | - | 1.1 | |
| | MT2(-), G(-) | 0.5 | - | 1.1 | |
| Gate Non-Trigger Voltage ($T_J = 125^\circ\text{C}$) | MT2(+), G(+) | 0.2 | - | - | V |
| | MT2(+), G(-) | 0.2 | - | - | |
| | MT2(-), G(-) | 0.2 | - | - | |

2. Indicates Pulse Test: Pulse Width ≤ 2.0 ms, Duty Cycle $\leq 2\%$.

BTB12-600CW3G, BTB12-800CW3G

Surface Mount – 800V

Dynamic Characteristics

| Characteristic | Symbol | Min | Typ | Max | Unit |
|--|-------------|------|-----|-----|------------------|
| Rate of Change of Commutating Current, See Figure 10. (Gate Open, $T_j = 125^\circ\text{C}$, No Snubber) | $(di/dt)_c$ | 3.0 | – | – | A/ms |
| Critical Rate of Rise of On-State Current ($T_j = 125^\circ\text{C}$, $f = 120\text{ Hz}$, $I_G = 2 \times I_{GT}$, $tr \leq 100\text{ ns}$) | di/dt | – | – | 50 | A/ μs |
| Critical Rate of Rise of Off-State Voltage ($V_D = 0.66 \times V_{DRM}$, Exponential Waveform, Gate Open, $T_j = 125^\circ\text{C}$) | dV/dt | 1500 | – | – | V/ μs |

Voltage Current Characteristic of SCR

| Symbol | Parameter |
|-----------|---|
| V_{DRM} | Peak Repetitive Forward Off State Voltage |
| I_{DRM} | Peak Forward Blocking Current |
| V_{RRM} | Peak Repetitive Reverse Off State Voltage |
| I_{RRM} | Peak Reverse Blocking Current |
| V_{TM} | Maximum On State Voltage |
| I_H | Holding Current |

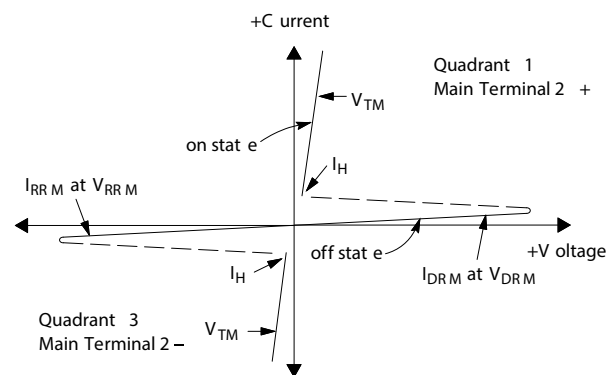

Quadrant Definitions for a Triac

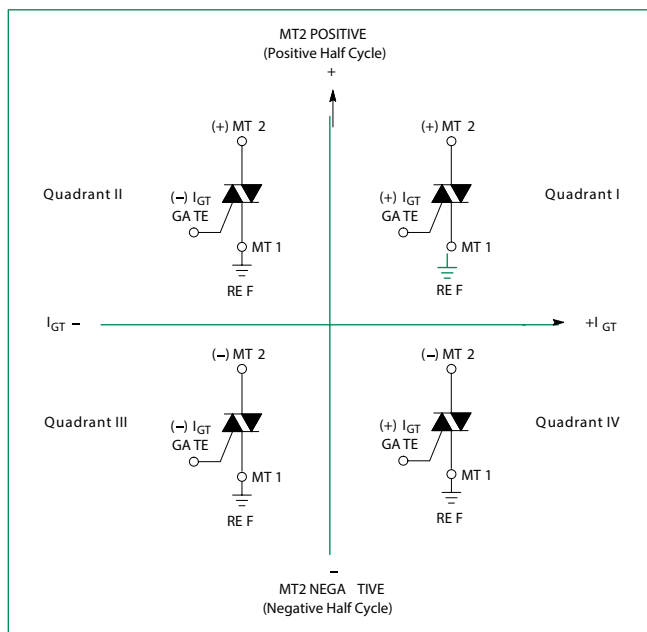

All polarities are referenced to MT1.
With in-phase signals (using standard AC lines) quadrants I and III are used

BTB12-600CW3G, BTB12-800CW3G

Surface Mount – 800V

Figure 1. RMS Current Derating

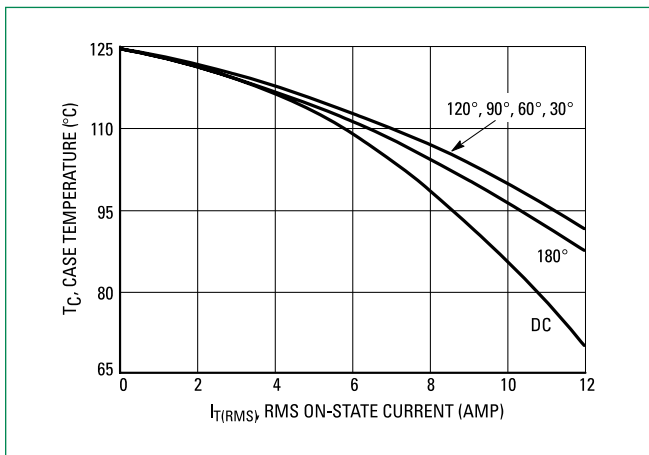

Figure 2. On-State Power Dissipation

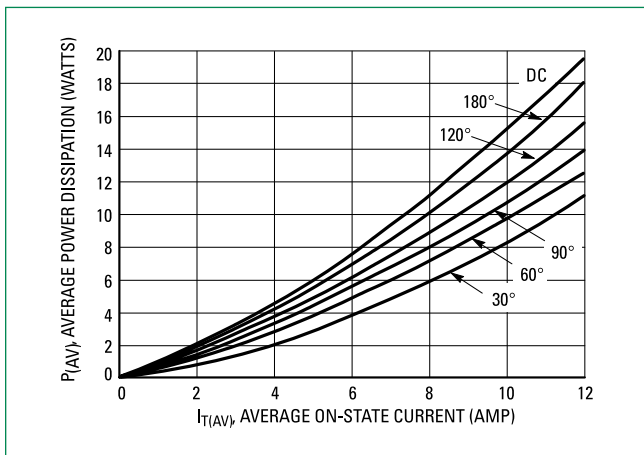

Figure 3. On-State Characteristics

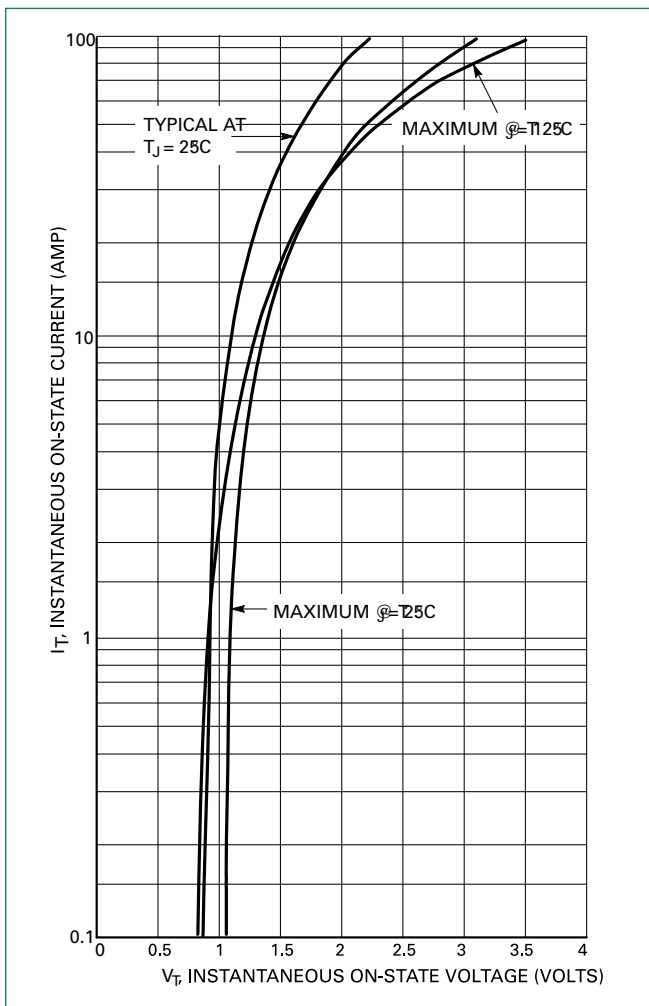

Figure 4. Thermal Response

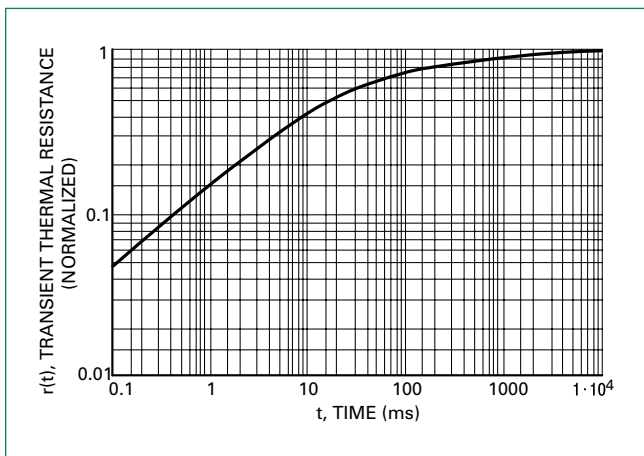
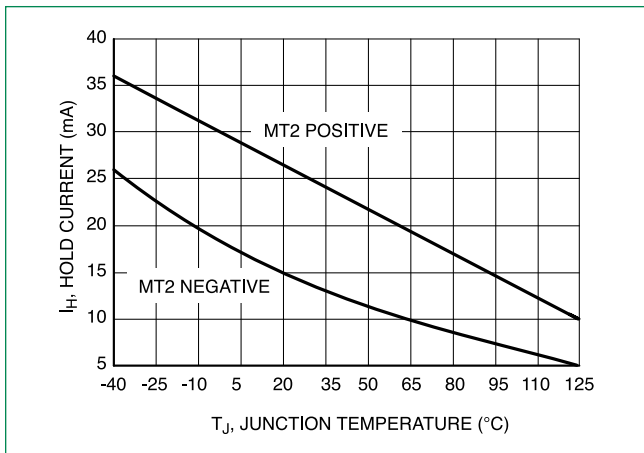

Figure 5. Typical Hold Current Variation



BTB12-600CW3G, BTB12-800CW3G

Surface Mount – 800V

Figure 6. Typical Gate Trigger Current Variation

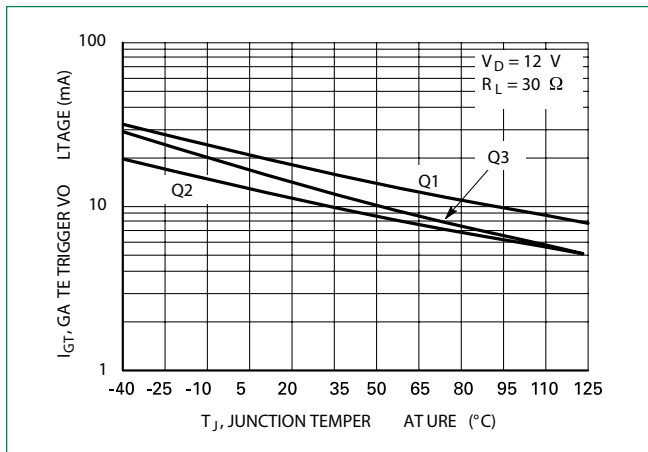

Figure 7. Typical Gate Trigger Voltage Variation

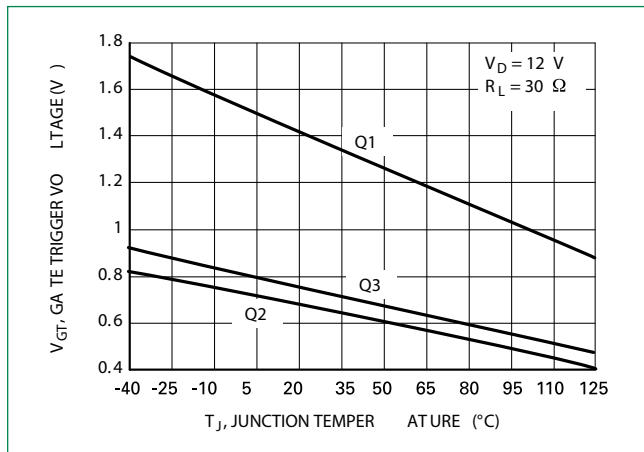

Figure 8. Critical Rate of Rise of Off-State Voltage (Exponential Waveform)

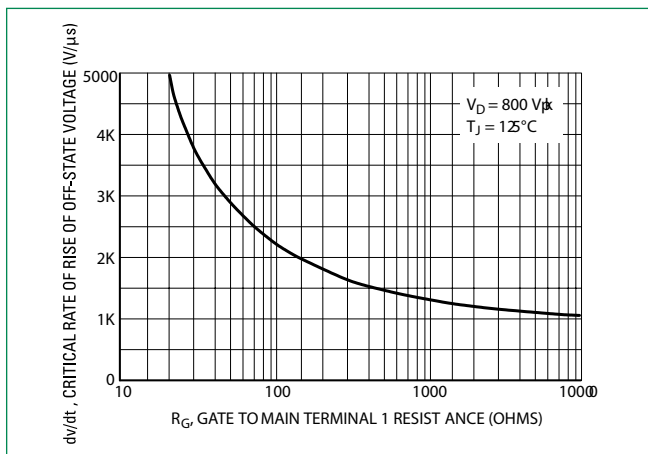
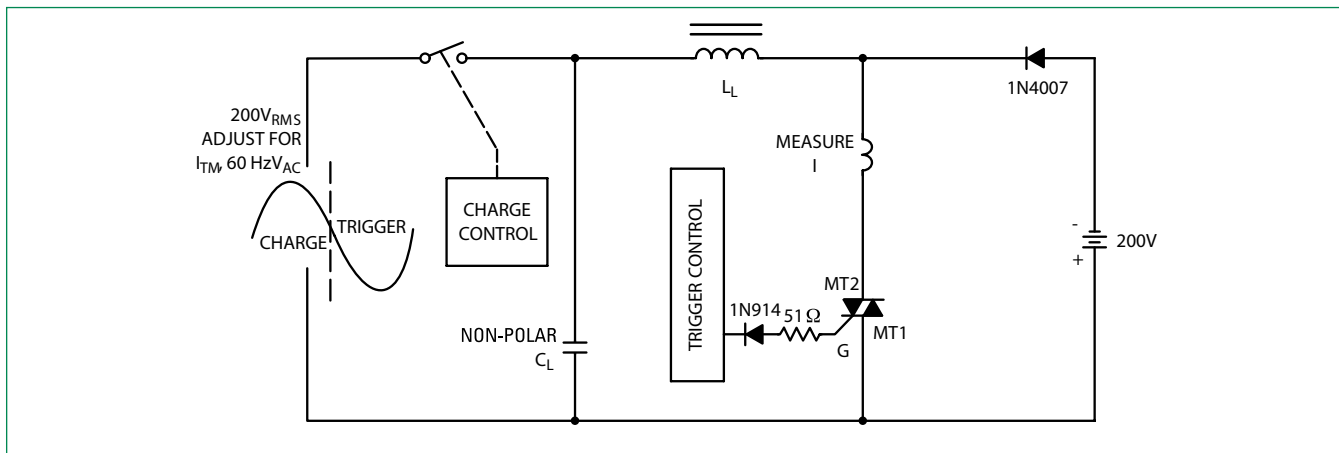

Figure 9. Simplified Test Circuit to Measure the Critical Rate of Rise of Commutating Current (di/dt)



Note: Component values are for verification of rated $(di/dt)_c$. See AN1048 for additional information

BTB12-600CW3G, BTB12-800CW3G

Surface Mount – 800V

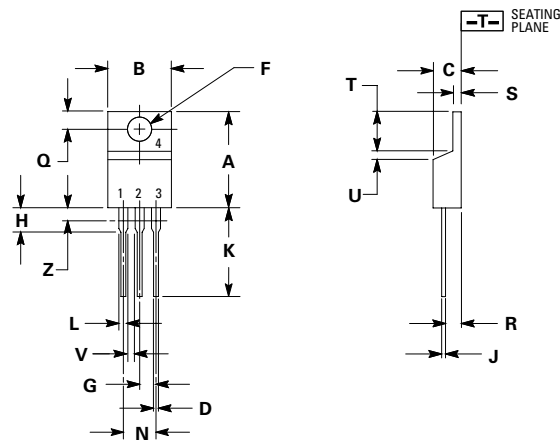
Dimensions

| Dim | Inches | | Millimeters | |
|-----|--------|-------|-------------|-------|
| | Min | Max | Min | Max |
| A | 0.590 | 0.620 | 14.99 | 15.75 |
| B | 0.380 | 0.420 | 9.65 | 10.67 |
| C | 0.178 | 0.188 | 4.52 | 4.78 |
| D | 0.025 | 0.035 | 0.64 | 0.89 |
| F | 0.142 | 0.147 | 3.61 | 3.73 |
| G | 0.095 | 0.105 | 2.41 | 2.67 |
| H | 0.110 | 0.130 | 2.79 | 3.30 |
| J | 0.018 | 0.024 | 0.46 | 0.61 |
| K | 0.540 | 0.575 | 13.72 | 14.61 |
| L | 0.060 | 0.075 | 1.52 | 1.91 |
| N | 0.195 | 0.205 | 4.95 | 5.21 |
| Q | 0.105 | 0.115 | 2.67 | 2.92 |
| R | 0.085 | 0.095 | 2.16 | 2.41 |
| S | 0.045 | 0.060 | 1.14 | 1.52 |
| T | 0.235 | 0.255 | 5.97 | 6.47 |
| U | 0.000 | 0.050 | 0.00 | 1.27 |
| V | 0.045 | — | 1.15 | — |
| Z | — | 0.080 | — | 2.04 |

1. Dimensioning and tolerancing per ansi y14.5m, 1982.

2. Controlling dimension: inch.

3. Dimension z defines a zone where all body and lead irregularities are allowed.

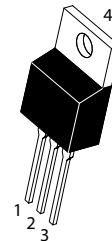
Part Marking System**TO-220AB
CASE 221A
STYLE 12**

x = 6 or 8
 Y = Year
 M = Month
 A = Assembly Site
 XX = Lot Serial Code
 G = Pb-Free Package

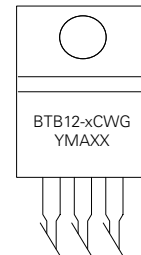

| Pin Assignment | |
|----------------|-----------------|
| 1 | Main Terminal 1 |
| 2 | Main Terminal 2 |
| 3 | Gate |
| 4 | Main Terminal 2 |

Ordering Information

| Device | Package | Shipping |
|---------------|-----------------------|------------------|
| BTB12-600CW3G | TO-220AB (Pb-Free) | 1000 Units / Box |
| BTB12-800CW3G | TO-220AB (Pb-Free) | 1000 Units / Box |

Disclaimer Notice - Information furnished is believed to be accurate and reliable. However, users should independently evaluate the suitability of and test each product selected for their own applications. Littelfuse products are not designed for, and may not be used in, all applications. Read complete Disclaimer Notice at <http://www.littelfuse.com/disclaimer-electronics>.