



250S Series



Agency Approvals

AGENCY	AGENCY FILE NUMBER
	E183209
	R50120008

Description

The 250S High Voltage Radial device is a Polymer-based PTC suitable to protect telephony equipment against lightning and power cross strikes. The 250S Series is fully compatible with telecommunications standards, and is offered in horizontal and new vertical surface mount package.

Features

- RoHS Compliant, Directive 2002/95/EC
- Lead-Free & Halogen-Free
- Low resistance
- Compatible with telecom standards
- Helps meet ITU K.20, K.21/Telcordia standards
- Excellent solder joint inspectability
- High voltage

Applications

- Customer Premises Equipment (CPE)
- Central Office (CO)/telecom centers
- LAN/WAN equipment
- Access equipment

Electrical Characteristics

Part Number	Device Mounting Layout	I _{hold} (A)	I _{trip} (A)	V _{max} (V _{int} /V _{op})	I _{max} (A)	P _g typ. (W)	Time to Trip at 1A		Resistance			Agency Approvals
							Typical (Sec.)	Maximum (Sec.)	R _{min} (Ω)	R _{max} (Ω)	R _{1max} (Ω)	
250S130	Horizontal	0.13	0.26	250/60	3	1.2	0.9	4.0	4	13	20	–
250S130-RA		0.13	0.26	250/60	3	1.2	1.4	4.0	6.5	10	15	–
250S130-RB		0.13	0.26	250/60	3	1.2	0.7	4.0	9	13	20	–
250S130-RC		0.13	0.26	250/60	3	1.2	1.1	4.0	7	11	17	–
250S130V	Vertical	0.13	0.26	250/60	3	1.2	2.0	4.0	4	13	20	–

I_{hold} = Hold current: maximum current device will pass without tripping in 20°C still air.
 I_{trip} = Trip current: minimum current at which the device will trip in 20°C still air.
 V_{max} = Maximum voltage the device can withstand without damage at rated current (I_{max})
 V_{op} = The device regular operation voltage
 I_{max} = Maximum fault current device can withstand without damage at rated voltage (V_{max})
 P_g = Power dissipated from device when in the tripped state at 20°C still air.

R_{min} = Minimum resistance of device in initial (un-soldered) state.
 R_{max} = Maximum resistance of device in initial (un-soldered) state.
 R_{1max} = Maximum resistance of device at 20°C measured one hour after tripping.
Caution: Operation beyond the specified rating may result in damage and possible arcing and flame.

WARNING

- Users shall independently assess the suitability of these devices for each of their applications
- Operation of these devices beyond the stated maximum ratings could result in damage to the devices and lead to electrical arcing and/or fire
- These devices are intended to protect against the effects of temporary over-current or over-temperature conditions and are not intended to perform as protective devices where such conditions are expected to be repetitive or prolonged in duration
- Exposure to silicon-based oils, solvents, electrolytes, acids, and similar materials can adversely affect the performance of these PPTC devices
- These devices undergo thermal expansion under fault conditions, and thus shall be provided with adequate space and be protected against mechanical stresses
- Circuits with inductance may generate a voltage (L di/dt) above the rated voltage of the PPTC device.

Temperature Rerating

Part Number	Ambient Operation Temperature								
	-40°C	-20°C	0°C	20°C	40°C	50°C	60°C	70°C	85°C
250S130	0.21	0.19	0.17	0.13	0.11	0.10	0.09	0.07	0.05

Average Time Current Curves

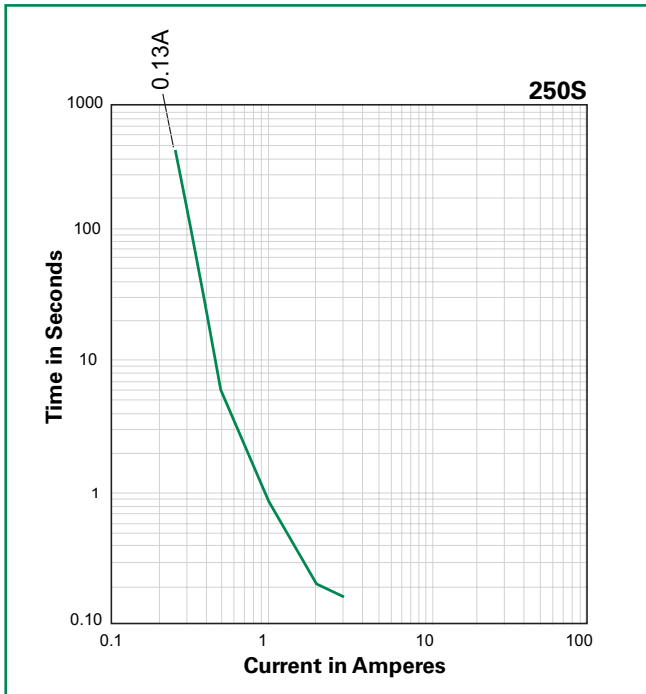

The average time current curves and Temperature Rerating curve performance is affected by a number of variables, and these curves provided as guidance only. Customer must verify the performance in their application.

Temperature Rerating Curve

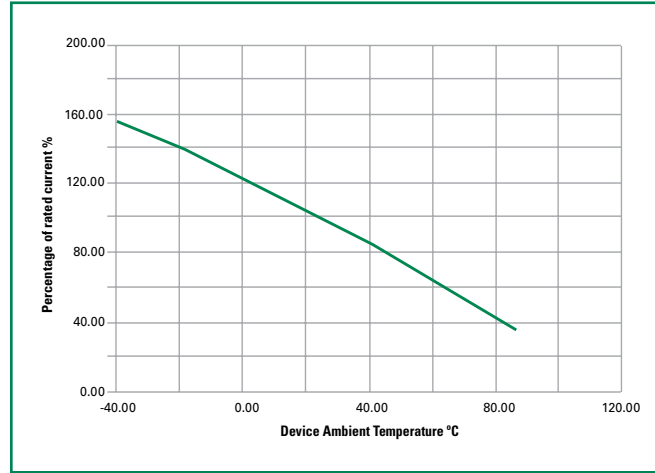

Agency Specification Selection Guide For Telecom and Networking Applications

Product	Lightning	Power Cross
250S130 250S130V 250S130-RA 250S130-RB 250S130-RC	ITU K.20/21/45 – 1.5kV 10/700µs	ITU K.20/21/45 – 230Vac, 10Ω

Protection Application Guide

Region/ Specification	Application	Device Selection
South America/ Asia/Europe ITU K.45	Access network equipment Remote terminal Repeaters WAN equipment Cross –connect	250S130 250S130V 250S130-RA 250S130-RB 250S130-RC
South America/ Asia/Europe ITU K.21	Customer and IT equipment Analog modems ADSL, xDSL Phone sets, PBX systems Internet appliances POS terminals	250S130 250S130V 250S130-RA 250S130-RB 250S130-RC
South America/ Asia/Europe ITU K.20	Central Office POTS/ISDN linecards T1/E1/J1 linecards ADSL/VDSL splitters CSU/DSU	250S130 250S130V 250S130-RA 250S130-RB 250S130-RC

Soldering Parameters

Profile Feature		Pb-Free Assembly
Average Ramp-Up Rate ($T_{S(max)}$ to T_P)		3°C/second max
Pre Heat:	Temperature Min ($T_{S(min)}$)	150°C
	Temperature Max ($T_{S(max)}$)	200°C
	Time (Min to Max) (t_s)	60 – 180 secs
Time Maintained Above:	Temperature (T_L)	217°C
	Temperature (t_L)	60 – 150 seconds
Peak / Classification Temperature (T_P)		260 ^{+0/-5} °C
Time within 5°C of actual peak Temperature (t_p)		20 – 40 seconds
Ramp-down Rate		6°C/second max
Time 25°C to peak Temperature (T_P)		8 minutes Max.

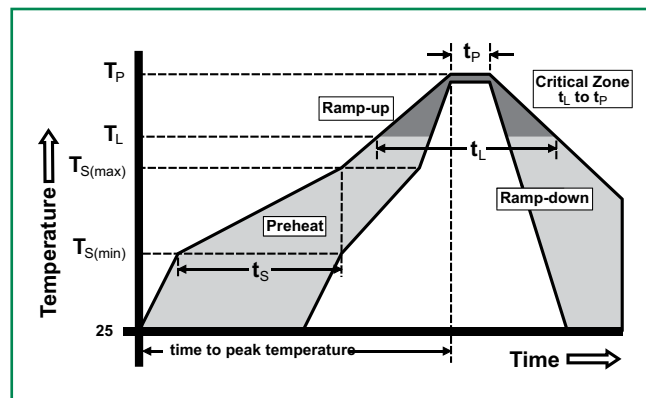

- All temperature refer to topside of the package, measured on the package body surface
- If reflow temperature exceeds the recommended profile, devices may not meet the performance requirements
- Recommended reflow methods: IR, vapor phase oven, hot air oven, N₂ environment for lead
- Recommended maximum paste thickness is 0.25mm (0.010inch)
- Devices can be cleaned using standard industry methods and solvents
- Devices can be reworked using the standard industry practices

Physical Specifications

Terminal Material	Solder-Plated Copper (Solder Material: Matte Tin(Sn))
Lead Solderability	Meets EIA Specification RS186-9E, ANSI/J-STD-002 Category 3.

Environmental Specifications

Operating/Storage Temperature	-40°C to +85°C
Maximum Device Surface Temperature in Tripped State	125°C
Passive Aging	+85°C, 1000 hours
Humidity Aging	+85°C, 85%, R.H., 1000 hours
Thermal Shock	MIL-STD-202, Method 107 +125°C to -55°C 10 times
Solvent Resistance	MIL-STD-202, Method 215
Moisture Sensitivity Level	Level 1, J-STD-020

Dimensions

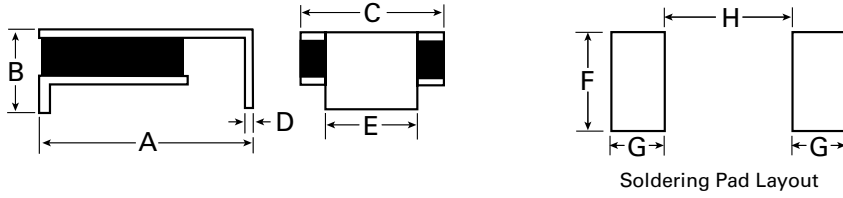

Soldering Pad Layout

Part Number	A		B		C		D		E		Material	F		G		H	
	Inch	mm	Inch	mm	Inch	mm	Inch	mm	Inch	mm		Inch	mm	Inch	mm	Inch	mm
	Max.	Max.	Max.	Max.	Max.	Max.	Max.	Max.	Max.	Max.		Max.	Max.	Max.	Max.	Max.	Max.
250S130	0.37	9.4	0.15	3.7	0.29	7.4	0.016	0.4	0.15	3.8	Sn/Ni/Cu	0.18	4.6	0.07	1.8	0.24	6.1
250S130-RA	0.37	9.4	0.15	3.7	0.29	7.4	0.016	0.4	0.15	3.8	Sn/Ni/Cu	0.18	4.6	0.07	1.8	0.24	6.1
250S130-RB	0.37	9.4	0.15	3.7	0.29	7.4	0.016	0.4	0.15	3.8	Sn/Ni/Cu	0.18	4.6	0.07	1.8	0.24	6.1
250S130-RC	0.37	9.4	0.15	3.7	0.29	7.4	0.016	0.4	0.15	3.8	Sn/Ni/Cu	0.18	4.6	0.07	1.8	0.24	6.1

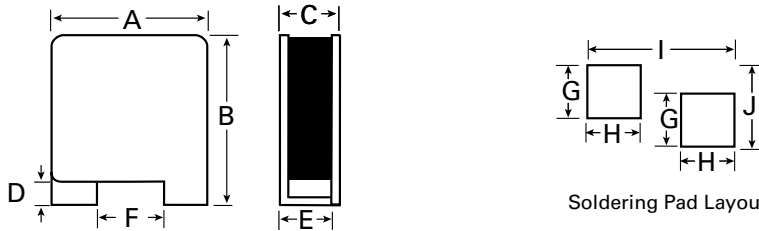

Soldering Pad Layout

Part Number	A		B		C		D		E		F		Material	G		H		I		J	
	Inch	mm	Inch	mm	Inch	mm	Inch	mm	Inch	mm	Inch	mm		Inch	mm	Inch	mm	Inch	mm	Inch	mm
	Max.	Max.	Max.	Max.	Max.	Max.	Max.	Max.	Max.	Max.	Max.	Max.		Max.	Max.	Max.	Max.	Max.	Max.	Max.	Max.
250S130V	.24	6.1	.27	6.9	.13	3.2	.04	1.6	.07	1.9	.09	2.3	Sn/Ni/Cu	.09	2.3	.09	2.4	.25	6.4	.14	3.43

Part Ordering Number System

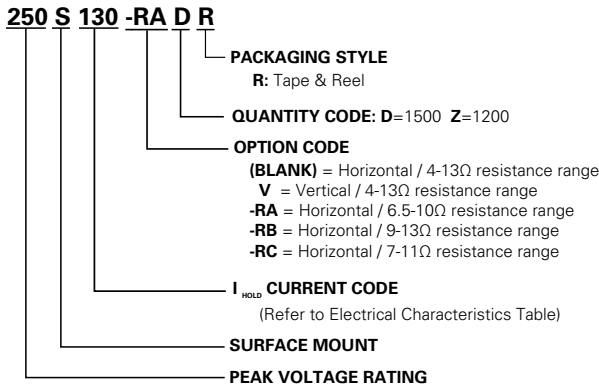

Packaging

Part Number	Ordering Number	I_{hold} (A)	I_{hold} Code	Packaging Option	Quantity	Quantity & Packaging Code
250S130	250S130DR	0.13	130	Tape and Reel	1500	DR
250S130V	250S130VZR	0.13	130	Tape and Reel	1200	ZR
250S130-RA	250S130-RADR	0.13	130	Tape and Reel	1500	DR
250S130-RB	250S130-RBDR	0.13	130	Tape and Reel	1500	DR
250S130-RC	250S130-RCDR	0.13	130	Tape and Reel	1500	DR

Tape and Reel Specifications

TAPE SPECIFICATIONS: EIA-481-1 (mm)	
W	16 +/-0.30
F	7.5 +/-0.05
E₁	1.75 +/-0.10
D₀	1.5 +/-0.05
D₁	1.00(MIN)
P₀	4.00 +/-0.10
P₁	12.00 +/-0.10
P₂	2.00 +/-0.05
A₀	6.9 +/-0.10
B₀	9.6 +/-0.10
T_{max}	0.4 +/-0.10
K₀	3.4 +/-0.15
Leader Min.	300
Trailer Min.	300

REEL DIMENSIONS: EIA-481-1 (mm)	
H	22.4 +/-0.05
W	16.4 .0 +0/+2
D	Ø60+0.5
F	Ø13.0+/-0.2
C	Ø340+/-1.0
H₁	11+/-0.5
W₁	2.2+/-0.5
W₂	3.0+0.5
W₃	4.0+0.5
W₄	5.5+0.5

Tape and Reel Diagram

