

Low Resistance Flat Chip Resistors

Type SR73

ISO 9000:2000 CERTIFIED
TS-16949 CERTIFIED

1. Scope

This specification applies to chip resistors (SR73) produced by KOA Corporation.

2. Type Designation

The type designation shall be in the following form:

SR73	2B	T	TD	1R00	F
Size	Size	Termination Material	Packaging	Nominal Resistance	Tolerance
1H 1E 1J 2A 2B 2E W2H W3A 2H* 3A*	T: Sn (Other termination styles may be available, please contact factory for options) G: Au (2A: 0.1Ω - 10Ω - contact factory)	TCM: 0201 only: 7" 2mm pitch pressed paper TPL:0402 only: 2mm pitch punch paper TP: 0402, 0603, 0805: 7" 2mm pitch punch paper TD: 0603, 0805, 1206, 1210: 7" 4mm pitch punched paper TDD: 0603, 0805, 1206, 1210: 10" paper tape TE: 0805, 1206, 1210, 2010 & 2512: 7" punched plastic TED: 0805, 1206, 1210, 2010 & 2512: 10" punched plastic	±2%, ±5%: 2 significant figures + 1 multiplier "R" indicates decimal on value <10Ω ±1%: 3 significant figures + 1 multiplier "R" indicates decimal on value <100Ω All values less than 0.1Ω (100mΩ) are expressed in mΩ with "L" as decimal Example: 20mΩ = 20L0	D: ±0.5% F: ±1% G: ±2% J: ±5%	

* Not recommended for new designs

3. Dimensions and Structure

3-1 Dimensions

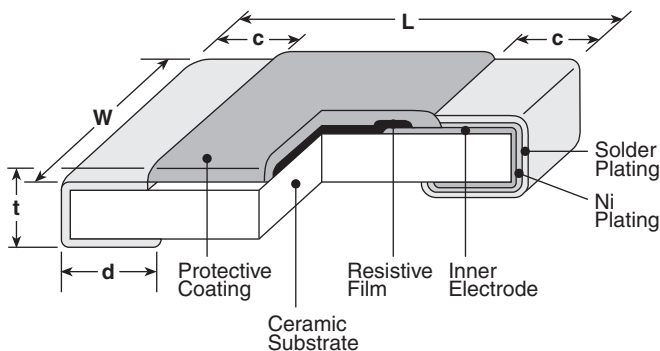

Type (Inch Size Code)	Dimensions inches (mm)				
	L	W	c	d	t
1H (0201)	.024±.001 (0.6±0.03)	.012±.001 (0.3±0.03)	.004±.002 (0.1±0.05)	.006±.002 (0.15±0.05)	.009±.001 (0.23±0.03)
1E (0402)	.039 ^{+0.004} _{-.002} (1.0 ^{+0.1} _{-0.05})	.02 ^{+0.004} _{-.002} (0.5 ^{+0.1} _{-0.05})	.01±.004 (0.25±0.1)	.01±.004 (0.25±0.1)	.014±.002 (0.35±0.05)
1J (0603)	.063±.008 (1.6±0.2)	.031 ^{+0.006} _{-.004} (0.8 ^{+0.15} _{-0.1})	.014±.004 (0.35±0.1)	.014±.004 (0.35±0.1)	.018±.004 (0.45±0.1)
2A (0805)	.079±.008 (2.0±0.2)	.049±.004 (1.25±0.1)	.016±.008 (0.4±0.2)	.012 ^{+0.008} _{-.004} (0.3 ^{+0.2} _{-0.1})	.02±.004 (0.5±0.1)
2B (1206)	.126±.008 (3.2±0.2)	.063±.008 (1.6±0.2)	.02±.012 (0.5±0.3)	.016 ^{+0.008} _{-.004} (0.4 ^{+0.2} _{-0.1})	.024±.004 (0.6±0.1)
2E (1210)		.102±.008 (2.6±0.2)			
2H (2010)		.098±.008 (2.5±0.2)			
W2H (2010)					
3A (2512)	.248±.008 (6.3±0.2)	.122±.008 (3.1±0.2)			
W3A (2512)				.026±.006 (0.65±0.15)	

4. Standard Applications

Part Designation*	Power Rating @ 70°C	T.C.R. (ppm/°C) Max.	Resistance Range				Absolute Maximum Working Voltage	Maximum Overload Voltage (5 Secs. Max.)	Operating Temperature Range
			E-24, E-96 (D±0.5%)	E-24, E-96 (F±1%)	E-24 (G±2%)	E-24 (J±5%)			
SR731H (0201)	0.1W	0 - ±500	—	—	—	—	1.0V	2.5V	-55°C to +125°C
		0 - ±400		1Ω - 10Ω**					
SR731E (0402)	1/8W (.125W) 1/6W (.166W ¹)	±200	—	0.51Ω - 10Ω**	0.51Ω - 10Ω	0.51Ω - 10Ω	1.11V	2.79V	
		±250	—	0.22Ω - 0.47Ω**	0.22Ω - 0.47Ω	0.22Ω - 0.47Ω			
		±300	—	0.1Ω - 0.2Ω**	0.1Ω - 0.2Ω	0.1Ω - 0.2Ω			
SR731J (0603)	1/5W (.2W)	±200	—	0.1Ω - 10Ω	0.1Ω - 10Ω	0.1Ω - 10Ω	1.41V	3.53V	
SR732A (0805)	1/4W (.25W) 1/3W (.33W ¹)	±100	0.15Ω - 10Ω	0.1Ω - 10Ω	—	—	1.58V	3.95V	
		±200	—	—	0.1Ω - 10Ω	0.1Ω - 10Ω			
		±500	—	—	—	0.051Ω - 0.091Ω			
		±800	—	—	—	0.030Ω - 0.047Ω			
SR732B (1206)	1/3W (.33W) 1/2W (.5W ¹)	±100	0.15Ω - 10Ω	0.1Ω - 10Ω	—	—	1.81V	4.54V	
		±200	—	—	0.1Ω - 10Ω	0.1Ω - 10Ω			
		±500	—	—	—	0.056Ω - 0.091Ω			
		±800	—	—	—	0.030Ω - 0.051Ω			
SR732E (1210)	1/2W (.5W) 2/3W (.66W ¹)	±100	—	0.1Ω - 10Ω	—	—	2.23V	5.59V	
		±200	—	—	0.1Ω - 10Ω	0.047Ω - 10Ω			
		±500	—	—	—	0.036Ω - 0.043Ω			
		±1000	—	—	—	0.024Ω - 0.033Ω			
SR732H/W2H ² (2010)	3/4W (.75W)	±100	—	0.1Ω - 10Ω	—	—	2.73V	6.84V	
		±200	—	—	0.1Ω - 10Ω	0.1Ω - 10Ω			
		±500	—	—	—	0.056Ω - 0.091Ω			
		±800	—	—	—	0.033Ω - 0.051Ω			
SR733A/W3A (2512)	1W	±100	—	0.1Ω - 10Ω	—	—	3.16V	7.90V	
		±200	—	—	0.1Ω - 10Ω	0.1Ω - 10Ω			
		±500	—	—	—	0.056Ω - 0.091Ω			
		±800	—	—	—	0.039Ω - 0.051Ω			

* Parentheses indicate EIA package size codes.

** 1H, 1E (F: ±1%) E-24 values only.

¹ Please contact factory for limitation of Surface Mount Temperature Rise.

² SR73W3AS (2010 size, 1 Watt) with limited Resistance Range - contact factory for details.

5. Rating

5-1 Rating

For temperature in excess of 70°C, the load shall be derated in accordance with the following figure.

Derating Curve

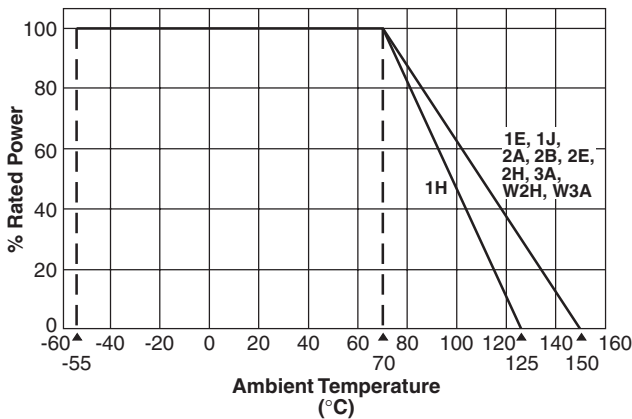

Surface Temperature Rise

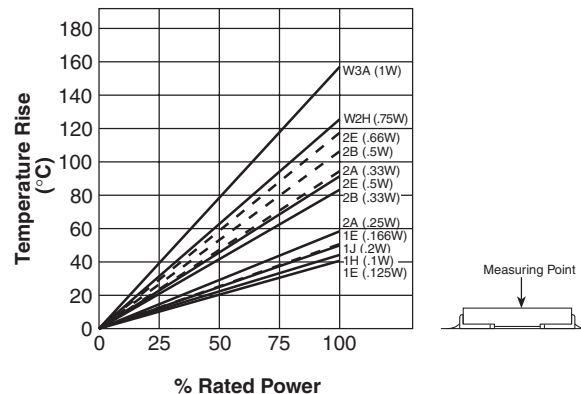

5-2 Voltage Rating

Resistors shall have a rated direct-current (DC) continuous working voltage or approximate sine-wave root-mean-square (RMS) continuous working voltage at commercial-line frequency and waveform corresponding to the power rating, as determined from the following formula:

$E = \sqrt{P \times R}$	<p>Where:</p> <p>E = Rated voltage (V) P = Rated power (W) R = Nominal resistance (Ω)</p>
-------------------------	---

In no case shall be rated DC or R.M.S. continuous working voltage be greater than the applicable maximum value.

6. Body and Marking

Type	Tolerance	Coating Color	Marking Color
SR73	D ($\pm 0.5\%$) F ($\pm 1\%$)	Indigo	White/ 4 digit
SR73	G ($\pm 2\%$) J ($\pm 5\%$)	Indigo	White/ 3 digit

Marking: a effective number and a multiplier. R means a decimal point.

7. Marking Method

D, F	4 digit	This character indicate Ω unit and express 4 effective numbers. R means a decimal point.
G, J	3 digit	This character indicate Ω unit and express 3 effective numbers. R means a decimal point.

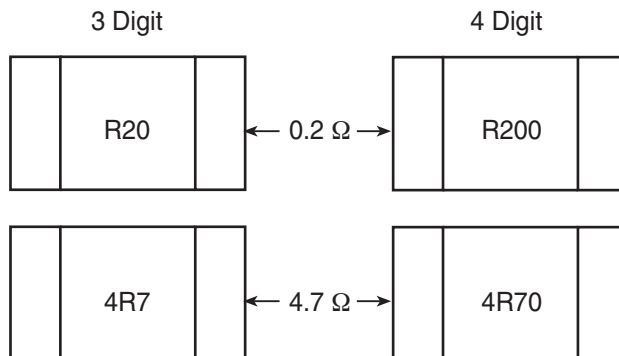

8. Characteristics

8-1 Mechanical Characteristics

Item	Requirement	Test Methods (JIS C 5202)
Withstanding Soldering Heat	No visual damage ± 1.0%	6.10 260°C ± 5°C 10 ± 1 sec.
Solderability	More than 95% of the surface of the termination must be covered new solder	6.11 230°C ± 5°C 3 ± 0.5 sec.
Termination Strength	± 1.0%	6.1.4 1) Bending 2A, 2B Circuit board bending 5mm Circuit board bending 2mm 2) Shear 3) Pull-off strength
Vibration	± 0.5%	6.3 Condition A Each direction / 2hrs
Withstanding Solvent	No visual & mechanical damage	1) 4.2 and 4.9 2) MIL-STD-202F Test method 215

8-2 Electrical Characteristics

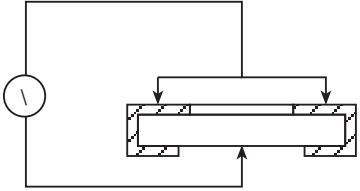
Item	Requirement	Test Methods (JIS C 5202)
Resistance	Within tolerance	5.1 Measuring Voltage A, 25 °C
Resistance of Temperature Coefficient	Within specified R.T.C -55°C/125°C	5.2 Condition B
Short Time Overload	± 2.0%	5.5 Condition A
Intermittent Overload	± 5.0%	5.8 Applied Voltage: RV x 2.5
Insulation	Above 10 ⁴ MΩ	5.5 500V DC The following sketch: 

8-2 Electrical Characteristics (Continued)

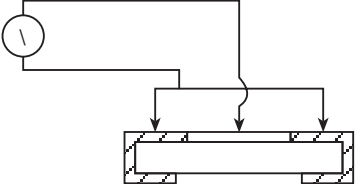
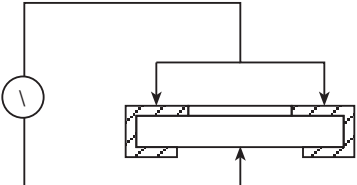
Item	Requirement	Test Methods (JIS C 5202)
Insulation	Above $10^3 M\Omega$	5.6 500V DC The following sketch: 
Withstanding Voltage	$\pm 0.5\%$	5.7 500V DC $60 \pm 10/0$ sec. The following sketch: 
Temperature Rise (Rated Load)	1) Surface temp. rise: $100^\circ C \geq$ 2) $\Delta R \pm 0.5\%$	5.4 1) Test board 90mm x 10mm x 1.6mm 2) Recommended land dimensions

8-3 Environmental Characteristics

Item	Requirement	Test Methods (JIS C 5202)
Thermal Shock (Air to Air)	$\pm 1.0\%$	-40°C 30 minutes 125°C 30 minutes 100 cycles
High Temperature Exposure	$\pm 1.0\%$	7.2 $125 \pm 3^\circ C$ 1000 hrs.
Load Life in Humidity	$\pm 2.0\%$	7.9 $40 \pm 2^\circ C$ 90 ~ 95% RH 1000 hrs.
Load Life	$\pm 2.0\%$	7.10 $70 \pm 3^\circ C$ 1000 hrs.

9. Recommended Land Dimensions

Dimensions in inches (mm)

9-1 Flow Soldering

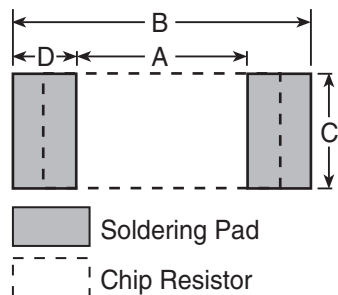

Type	Style	Resistor Size	A	B	C	D
SR73	1 E	0.039 x 0.020 (1.0 x 0.5)	0.020 (0.5)	0.059 (1.5)	0.020 (0.5)	0.020 (0.5)
	1 J	0.063 x 0.031 (1.6 x 0.8)	0.039 (1.0)	0.094 (2.4)	0.031 (0.8)	0.028 (0.7)
	2 A	0.079 x 0.049 (2.0 x 1.25)	0.051 (1.3)	0.122 (3.1)	0.049 (1.25)	0.035 (0.9)
	2 B	0.126 x 0.063 (3.2 x 1.6)	0.087 (2.2)	0.173 (4.4)	0.063 (1.6)	0.043 (1.1)
	2 E	0.126 x 0.098 (3.2 x 2.5)	0.087 (2.2)	0.173 (4.4)	0.098 (2.5)	0.043 (1.1)
	2 H	0.197 x 0.098 (5.0 x 2.5)	0.138 (3.5)	0.248 (6.3)	0.098 (2.5)	0.055 (1.4)
	3 A	0.252 x 0.126 (6.4 x 3.2)	0.181 (4.6)	0.315 (8.0)	0.126 (3.2)	0.067 (1.7)

9-2 Reflow Soldering

Dimensions in inches (mm)

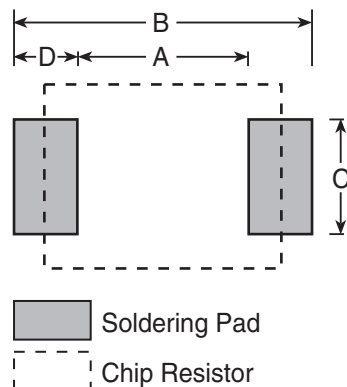

Type	Style	Resistor Size	A	B	C	D
SR73	1 E	0.039 x 0.020 (1.0 x 0.5)	0.020 (0.5)	0.051 (1.3)	0.012 (0.3)	0.016 (0.4)
	1 J	0.063 x 0.031 (1.6 x 0.8)	0.039 (1.0)	0.079 (2.0)	0.024 (0.6)	0.020 (0.5)
	2 A	0.079 x 0.049 (2.0 x 1.25)	0.051 (1.3)	0.098 (2.5)	0.041 (1.05)	0.024 (0.6)
	2 B	0.126 x 0.063 (3.2 x 1.6)	0.087 (2.2)	0.157 (4.0)	0.055 (1.4)	0.035 (0.9)
	2 E	0.126 x 0.098 (3.2 x 2.5)	0.087 (2.2)	0.157 (4.0)	0.091 (2.3)	0.035 (0.9)
	2 H	0.197 x 0.098 (5.0 x 2.5)	0.138 (3.5)	0.248 (6.3)	0.091 (2.3)	0.055 (1.4)
	3 A	0.252 x 0.126 (6.4 x 3.2)	0.181 (4.6)	0.315 (8.0)	0.118 (3.0)	0.067 (1.7)

10. Taping

10-1 Taped Configuration

Dimensions in inches (mm)

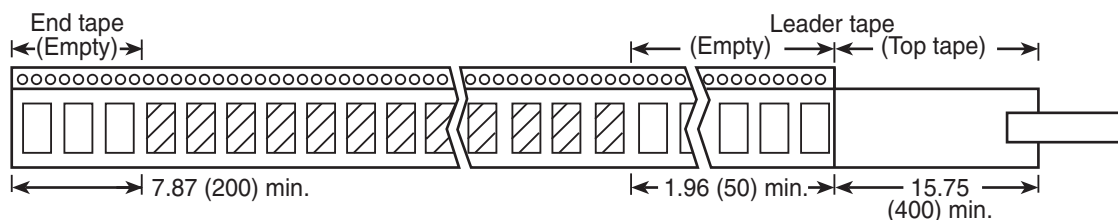

10-2 Dimensions of Punched Paper Tape

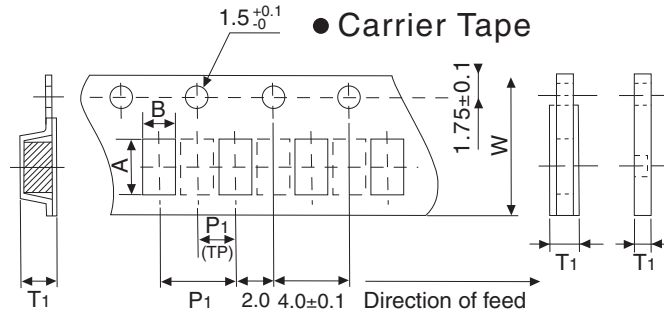

(Notes) Dotted lines are applicable to only "TP" and "TB."

Type	Component Size (mm)			Carrier Tape	Quantity/ Reel (Pieces)	Taping (mm)					Reel Size	
	L	W	T			A	B	W	P1	T1		
SR73	1E	1	0.5	0.35	TP	10000	1.15±0.1	0.65±0.1	8.0±0.2	2±0.05	0.45+0.2/-0	178
					TP	10000	1.9±0.1	1.1±0.1	8.0±0.2	2±0.05	0.6+0.2/-0	178
	1J	1.6	0.8	0.45	TD	5000	1.9±0.1	1.1±0.08	8.0±0.2	4.0±0.1	0.6+0.2/-0	178
					TDD	10000	1.9±0.1	1.1±0.1	8.0±0.2	4.0±0.1	0.6+0.2/-0	255
	2A	2	1.25	0.5	TP	10000	2.4±0.2	1.65±0.2	8.0±0.2	2±0.05	0.75+0.2/-0	178
					TD	5000	2.4±0.2	1.65±0.2	8.0±0.2	4.0±0.1	0.75+0.2/-0	178
					TE	4000	2.4±0.2	1.6±0.2	8.0±0.2	4.0±0.1	0.9±0.1	178
					TDD	10000	2.4±0.1	1.65±0.1	8.0±0.2	4.0±0.1	0.75+0.2/-0	255
	2B	3.2	1.6	0.6	TED	10000	2.4±0.2	1.45±0.15	8.0±0.2	4.0±0.1	0.65±0.1	255
					TD	5000	3.5±0.2	2±0.2	8.0±0.2	4.0±0.1	0.75+0.2/-0	178
					TE	4000	3.5±0.2	1.9±0.2	8.0±0.2	4.0±0.1	1.0±0.1	178
					TDD	10000	3.5±0.1	1.9±0.1	8.0±0.2	4.0±0.1	0.75+0.2/-0	255
	2E	3.2	2.6	0.6	TED	10000	3.5±0.1	1.9±0.2	8.0±0.2	4.0±0.1	1.0±0.1	255
					TD	5000	3.5±0.2	2.85±0.2	8.0±0.2	4.0±0.1	0.75+0.2/-0	178
					TE	4000	3.5±0.2	2.85±0.2	8.0±0.2	4.0±0.1	1.0±0.15	178
					TDD	10000	3.5±0.1	2.8±0.1	8.0±0.2	4.0±0.1	0.75+0.2/-0	255
	2H	5	2.5	0.6	TED	10000	3.6±0.15	2.9±0.15	8.0±0.2	4.0±0.1	1.0±0.1	255
					TE	4000	5.35±0.2	2.9±0.2	12.0±0.1	4.0±0.1	1.0±0.15	178
					TED	10000	5.4±0.2	2.9±0.2	12.0±0.1	4.0±0.1	0.85±0.1	255
	3A	6.3	3.1	0.6	TE	4000	6.65±0.2	3.44±0.2	12.0±0.1	4.0±0.1	1.0±0.15	178
TED					10000	6.9±0.2	3.6±0.2	12.0±0.1	4.0±0.1	0.85±0.1	255	

11-5 Dimensions of Reel

Dimensions in inches (mm)

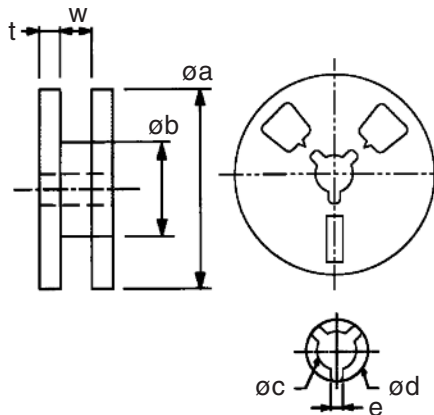

Size Code	øa max.		øb	w	t	øc	ød	e
	7"	10"						
1 H (0201)								
1 E (0402)			3.150 (80 ± 2.0)	0.394 (10 ± 1.0)			1.063 (27 ± 2.0)	.118 (3.0 ± 0.5)
1 J (0603)								
2 A (0805)	7.008 (178)	10.039 (255)			.059 (1.5 ± 0.05)	0.512 (13 ± 0.5)		
2 B (1206)								
2 E (1210)			2.362 (60 ± 2.0)	0.551 (14 ± 1.0)			.827 (21 ± 2.0)	.079 (2.0 ± 0.5)
2 H (2010)								
3 A (2512)								

Quantity per reel or reel size are requested to designate at the time of ordering.

Contents on label:

- | | |
|---|--|
| (1) Article number (SR73K2ATD J) | (4) Customer's code number (subject to change) |
| (2) Quantity | (5) Production lot number |
| (3) Nominal Resistance and the chip marking [Ex: 0.2 Ω (R20)] | (6) Manufacturer's name |

10. Packing

Lot number (8 digits)

<u>89</u>	<u>12</u>	<u>3001</u>
Production year, month	Date	Additional day number

41~52	January 2006 ~ December 2006
53~64	January 2007 ~ December 2007

11. Packaging Method

Size Code	TE 7" Embossed Plastic	TP 7" Punched Paper	TD Punched Paper	TED 10" Embossed Plastic	TDD 10" Punched Paper
1 E (0402)	—	10,000	—	—	—
1 J (0603)	—	10,000	5,000	—	10,000
2 A (0805)	4,000	10,000	5,000	10,000	10,000
2 B (1206)	4,000	—	5,000	10,000	10,000
2 E (1210)	4,000	—	5,000	10,000	10,000
2 H (2010)	4,000	—	—	10,000	—
3 A (2512)	4,000	—	—	10,000	—