



Defense
and Aerospace

KEMET
CHARGED.™

Ceramic Surface Mount Capacitors

	KEMET Series	Page
Performance Information		1
MIL-PRF-55681/01/02/03/ 04/05/06	C0805P/C1805P/C1808P C1812P/C1825P/C2225P	6
MIL-PRF-55681/31/32/ 33/34/35	C0805N/C1206N/ C1210N/C1812N/C1825N	6, 8
Packaging		11

INTRODUCTION

Ceramic chips consist of formulated ceramic dielectric materials which have been fabricated into thin layers, interspersed with metal electrodes alternately exposed on opposite edges of the laminated structure. The entire structure is then fired at high temperature to produce a monolithic block which provides high capacitance values in a small physical volume. After firing, conductive terminations are applied to opposite ends of the chip to make contact with the exposed electrodes. Standard end terminations use a nickel barrier layer and a tin overplate to provide excellent solderability for the customer.

KEMET multilayer ceramic chip capacitors are produced in plants designed specifically for chip capacitor manufacture. The process features a high degree of mechanization as well as precise controls over raw materials and process conditions. Manufacturing is supplemented by extensive Technology, Engineering and Quality Assurance programs.

KEMET military ceramic chip capacitors are offered in two most popular temperature characteristics. These are designated by the Electronics Industries Association (EIA) as the ultra-stable C0G (also known as NP0, military version BP), the stable X7R (military BX or BR). A wide range of sizes are available. KEMET multi-layer ceramic chip capacitors are available in KEMET's tape and reel packaging, compatible with automatic placement equipment.

ELECTRICAL CHARACTERISTICS

1. Working Voltage:

Refers to the maximum continuous DC working voltage permissible across the entire operating temperature range. The reliability of multilayer ceramic capacitors is not extremely sensitive to voltage, and brief applications of voltage above rated will not result in immediate failure. However, reliability will be degraded by sustained exposure to voltages above rated.

2. Temperature Characteristics:

Within the EIA classifications, various temperature characteristics are identified by a three-symbol code; for example: C0G, X7R.

For Class I temperature compensating dielectrics (includes C0G), the first symbol designates the significant figures of the temperature coefficient in PPM per degree Celsius, the second designates the multiplier to be applied, and the third designates the tolerance in PPM per degrees Celsius. EIA temperature characteristic codes for Class I dielectrics are shown in Table 1.

Table 1 – EIA Temperature Characteristic Codes for Class I Dielectrics

Significant Figure of Temperature Coefficient		Multiplier Applied to Temperature Coefficient		Tolerance of Temperature Coefficient	
PPM per Degree C	Letter Symbol	Multiplier	Number Symbol	PPM per Degree C	Letter Symbol
0.0	C	-1	0	± 30	G
0.3	B	-10	1	± 60	H
0.9	A	-100	2	± 120	J
1.0	M	-1000	3	± 250	K
1.5	P	-10000	4	± 500	L

KEMET supplies the C0G characteristic.

For Class II and III dielectrics (including X7R) the first symbol indicates the lower limit of the operating temperature range, the second indicates the upper limit of the operating temperature range, and the third indicates the maximum capacitance change allowed over the operating temperature range. EIA type designation codes for Class II and III dielectrics are shown in Table 2.

Table 2 – EIA Temperature Characteristic Codes for Class II & III Dielectrics

Low Temperature Rating		High Temperature Rating		Maximum Capacitance Shift		
Degree Celsius	Letter Symbol	Degree Celsius	Number Symbol	Percent	Letter Symbol	EIA Class
+10C	Z	+45C	2	± 1.0%	A	II
-30C	Y	+65C	4	± 1.5%	B	II
-55C	X	+85C	5	± 2.2%	C	II
		+105C	6	± 3.3%	D	II
		+125C	7	± 4.7%	E	II
		+150C	8	± 7.5%	F	II
		+200C	9	± 10.0%	P	II
				± 15.0%	R	II
				± 22.0%	S	III
				+ 22/-33%	T	III
				+22/-56%	U	III
				+22/-82%	V	III

KEMET supplies the X7R characteristic.

3. Capacitance Tolerance:

See tables on pages 7-10.

4. Capacitance:

Within specified tolerance when measured per Table 3.

The standard unit of capacitance is the farad. For practical capacitors, capacitance is usually expressed in microfarads (10^{-6} farad), nanofarads (10^{-9} farad), or picofarads (10^{-12} farad). Standard measurement conditions are listed in Table 3 - Specified Electrical Limits.

Like all other practical capacitors, multilayer ceramic capacitors also have resistance and inductance. A simplified schematic for the single frequency equivalent circuit is shown in Figure 1. At high frequency more complex models apply - see KEMET SPICE models at www.kemet.com for details.

Figure 1

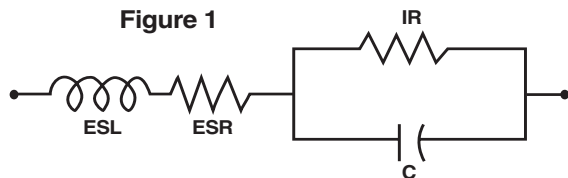

C = Capacitance
ESL = Equivalent Series Inductance
ESR = Equivalent Series Resistance
IR = Insulation Resistance

**5. Dissipation Factor:
Measured under same conditions as
capacitance. (See Table 3)**

Dissipation factor (DF) is a measure of the losses in a capacitor under AC application. It is the ratio of the equivalent series resistance to the capacitive reactance, and is usually expressed in percent. It is normally measured simultaneously with capacitance, and under the same conditions. The vector diagram below illustrates the relationship between DF, ESR and impedance. The reciprocal of the dissipation factor is called the “Q” or quality factor. For convenience, the “Q” factor is often used for very low values of dissipation factor especially when measured at high frequencies. DF is sometimes called the “loss tangent” or “tangent δ”, as shown in Figure 2.

Figure 2

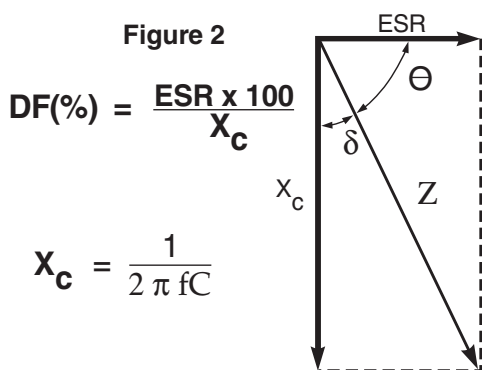

$$DF(\%) = \frac{ESR \times 100}{X_C}$$

$$X_C = \frac{1}{2\pi fC}$$

6. Impedance:

Since the parallel resistance (IR) is normally very high, the total impedance of the capacitor can be approximated by:

Figure 3

$$Z = \sqrt{ESR^2 + (X_L - X_C)^2}$$

Where: Z = Total Impedance

ESR = Equivalent Series Resistance

X_C = Capacitive Reactance = 1/(2 πfC)

X_L = Inductive Reactance = (2 πf) (ESL)

The variation of a capacitor's impedance with frequency determines its effectiveness in many applications. At high frequency more detailed models apply - see KEMET SPICE models for such instances.

7. Insulation Resistance:

Measured after 2 minutes electrification at 25°C and rated voltage: Limits per Table 3.

Insulation Resistance is the measure of a capacitor to resist the flow of DC leakage current. It is sometimes referred to as “leakage resistance”. Insulation resistance (IR) is the DC resistance measured across the terminals of a capacitor, represented by the parallel resistance (IR) shown in Figure 1. For a given dielectric type, electrode area increases with capacitance, resulting in a decrease in the insulation resistance. Consequently, insulation resistance limits are usually specified as the “RC” (IR x C) product, in terms of ohm-farads or megohm-micro-farads. The insulation resistance for a specific capacitance value is determined by dividing this product by the capacitance. However, as the nominal capacitance values become small, the insulation resistance calculated from the RC product reaches values which are impractical. Consequently, IR specifications usually include both a minimum RC product and a maximum limit based on the IR calculated

Table 3 – Specified Electrical Limits

Parameter	Temperature Characteristics	
	C0G	X7R
Capacitance & Dissipation Factor: Measured at following conditions: C0G – 1 kHz and 1 vrms if capacitance >1000 pF C0G – 1 MHz and 1 vrms if capacitance ≤1000 pF X7R – 1 kHz and 1 vrms* if capacitance ≤10µF X7R – 120 Hz and 0.5 vrms if capacitance ≤10µF		
50 - 200 volts –	0.10%	2.50%
25 volts –	0.10%	3.50%
16 volt –	3.50%
6.3/10 volts –	5.00%
Dielectric Strength: At 2.5 times rated DC voltage	Pass subsequent IR test	
Insulation Resistance (IR): At rated DC voltage, whichever of the two is smaller. To get IR limit, divide MΩ–µF value by the capacitance and compare to GΩ limit. Select the lower of the two limits.	1,000MΩ – µF or 100 GΩ (1000,000 MΩ)	1,000MΩ – µF or 100 GΩ (1000,000 MΩ)
Temperature: Range °C Capacitance Change (without DC voltage)	-55 to +125° 0 ± 30 ppm/°C	-55 to +125° ±15%

from that value. For example, a typical IR specification might read “1,000 megohm-microfarads or 100 gigohms, whichever is less”. The DC leakage current may be calculated by dividing the applied voltage by the insulation resistance (Ohm’s Law).

8. Dielectric Withstanding Voltage:
250% of rated voltage for 5 seconds with current limited to 50mA at 25°C. Limits per Table 3.

Dielectric withstanding voltage (DWV) is the peak DC voltage which a capacitor is designed to withstand without damage for short periods of time. All KEMET multilayer ceramic surface mount capacitors will withstand a DC test voltage of 2.5 x the rated voltage for 60 seconds.

KEMET specification limits for all electrical characteristics at standard measurement conditions are shown in Table 3. Variations in these properties caused by changing conditions (temperature, voltage, frequency, and time) are covered in the following sections.

9. Aging Rate:
Maximum % Capacitance Loss/Decade Hour
COG - 0%
X7R - 2.0%
Actual rates may be lower. Consult factory for details.

The capacitance of Class II and III dielectric changes with time as well as with temperature, voltage and frequency. The change with time is known as “aging”. It is caused by gradual realignment of the crystalline structure of the ceramic dielectric material as it is cooled below its Curie temperature, which produces a loss of capacitance with time. The aging process is predictable and follows a logarithmic decay.

The aging process is reversible. If the capacitor is heated to a temperature above its Curie point for some period of time, de-aging will occur and the capacitor will regain the capacitance lost during the aging process. The amount of de-aging depends on both the elevated temperature and the length of time at that temperature. Exposure to 150°C for one-half hour is sufficient to return the capacitor to its initial value.

Because the capacitance changes rapidly immediately after de-aging, capacitance measurements are usually delayed for at least 24-48 hours after the de-aging process, which is often referred to as the “last heat”. In addition, manufacturers utilize the aging rates to set factory test limits which will bring the capacitance within the specified tolerance at some future time, to allow for customer receipt and use.

10. Effect of Temperature:

Both capacitance and dissipation factor are affected by variations in temperature. The maximum capacitance change with temperature is defined by the temperature characteristic.

However, this only defines an “envelope” bounded by the upper and lower operating temperatures and the minimum and maximum capacitance values. Within this “envelope”, the variation with temperature depends upon the specific dielectric formulation.

Insulation resistance decreases with increasing temperature. Typically, the insulation resistance limit at maximum rated temperature is 10% of the 25°C value.

11. Effect of Voltage:

Certain high dielectric constant ceramic capacitors may show variation in values of capacitance and dissipation factor with various levels of applied AC and DC voltages. Such variation is a natural characteristic of ceramic capacitors, and should be considered by the circuit designer.

In general, ceramic capacitors with the lowest dielectric constant (COG or NP0) are extremely stable, and show little or no variation in capacitance and/or dissipation factor. Other dielectric formulations such as X7R will show more variation than COG.

The application of AC voltages in the range of 10 to 20 VAC tends to increase the values of both the capacitance and dissipation factor, while higher AC voltages tend to produce decreases in both.

However, the variation of capacitance with applied DC is the parameter of most interest to design engineers. Figure 4 shows typical variation of capacitance with applied DC voltage for some standard dielectrics.

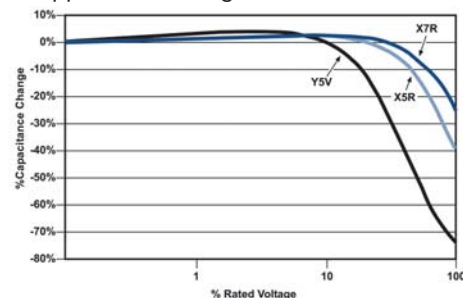

Figure 4 - Typical Variation of Capacitance with Applied DC Voltage

More detailed modelling information on the effect of various voltages on specific capacitor ratings can be obtained by use of the KEMET SPICE models, available for free downloading at our website (www.kemet.com).

12. Effect of Frequency:

Frequency affects both capacitance and dissipation factor. Typical curves for KEMET multilayer ceramic capacitors are shown in Figures 5 and 6.

The variation of impedance with frequency is an important consideration in the application of multilayer ceramic capacitors. Total impedance of the capacitor is the vector summation of the capacitive reactance, the inductive reactance, and the ESR, as illustrated in

Figure 2. As frequency increases, the capacitive reactance decreases. However, the series inductance (L) shown in Figure 1 produces some inductive reactance, which increases with frequency. At some frequency, the impedance ceases to be capacitive and becomes inductive. This point, at the bottom of the V-shaped impedance versus frequency curves, is the self-resonant frequency. At the self-resonant frequency, the reactance is zero, and the impedance consists of the ESR only. At high frequency more detailed models apply - See KEMET SPICE models for such instances.

Typical impedance versus frequency curves for KEMET multilayer ceramic capacitors are shown in Figures 5 and 6.

ENVIRONMENTAL AND PHYSICAL

13. **Thermal Shock:**
EIA-198, Method 202, Condition B (5 cycles -55° to + 125°C).
14. **Life Test:**
EIA-198, Method 201, 1000 hours at 200% of rated voltage at 125°C. (Except 85°C for Z5U and Y5V).
See Table 4 on page 5 for limits.
15. **Humidity Test:**
EIA-198, Method 206, (Except 1000 hours,85°C, 85% RH, Rated Voltage).
See Table 4 on page 5 for limits.
16. **Moisture Resistance:**
EIA-198, Method 204, Condition B (20 cycles with 50 volts applied).
See Table 4 on page 5 for limits.
17. **Solderability:**
EIA-198, Method 301 (245°, 5 secs, Sn62 solder) 95% smooth solder on terminations. See page 10 of Tantalum Surface Mount section for recommended profiles.
18. **Resistance to Soldering Heat:**
EIA-198, Method 302, Condition B (260°C, 10 seconds) no leaching of nickel barrier.
19. **Terminal Strength:**
EIA-198, Method 303, Condition D .

RELIABILITY

20. A well constructed multilayer ceramic capacitor chip is extremely reliable and, for all practical purposes, has no wearout mechanism when used within the maximum voltage and temperature ratings. Most failures occur as a result of mechanical or thermal damage during mounting on the board, or during subsequent testing. Capacitor failure may also be induced by sustained operation at voltages that exceed the rated DC voltage, voltage spikes or transients that exceed the dielectric's voltage capability, sustained operation at temperatures above the maximum rated temperature, internal defects, or excessive temperature rise due to power

dissipation. As with any practical device, multilayer ceramic capacitors also possess an inherent, although low, failure rate when operated within rated conditions. The primary failure mode is by short-circuit or low insulation resistance, resulting from cracks or from dielectric breakdown at a defect site. KEMET monitors reliability with a periodic sampling program for selected values.

21. Storage and Handling:

Ceramic chip capacitors should be stored in normal working environments. While the chips themselves are quite robust in other environments, solderability will be degraded by exposure to high temperatures, high humidity, corrosive atmospheres, and long term storage. In addition, packaging materials will be degraded by high temperature – reels may soften or warp, and tape peel force may increase. KEMET recommends that maximum storage temperature not exceed 40 degrees C, and maximum storage humidity not exceed 70% relative humidity. In addition, temperature fluctuations should be minimized to avoid condensation on the parts, and atmospheres should be free of chlorine and sulfur bearing compounds. For optimized solderability, chip stock should be used promptly, preferably within 1.5 years of receipt.

MISAPPLICATION

22. Ceramic capacitors, like any other capacitors, may fail if they are misapplied. Some misapplications include mechanical damage, such as impact or excessive flexing of the circuit board. Others include severe mounting or rework cycles that may also introduce thermal shock. Still others include exposure to excessive voltage, current or temperature. If the dielectric layer of the capacitor is damaged by misapplication, the circuit may fail. The electrical energy of the circuit can be released as heat, which may damage the circuit board and other components as well.

ADDITIONAL INFORMATION

23. Detailed application information can be found in KEMET Engineering Bulletins.

F-2100	Surface Mount-Mounting Pad Dimensions and Considerations
F-2102	Reflow Soldering Process
F-2105	Wave Solder Process
F-2103	Surface Mount Repair
F-2110	Capacitance Monitoring while Flex Testing
F-2111	Ceramic Chip Capacitors "Flex Cracks" - Understanding and Solutions

For analysis of high frequency applications, KEMET has SPICE models of most chip capacitors. Models may be downloaded from KEMET's website www.kemet.com.

Additional information is also available - See your KEMET representative for details or post your questions to KEMET's homepage on the web <http://www.kemet.com>.

TABLE 4 – ENVIRONMENTAL LIMITS

Body	Rated DC Voltage	Initial DF (%)	IR (GΩ or ΩF) whichever is less	DF (%) Post Life/ Hum/Moisture Resistance	Cap Shift (% or pF, whichever is greater) Post Life/Hum/ Moisture Resistance	IR (GΩ or ΩF) whichever is less Post Life/Hum/ Moisture Resistance
C0G	200*	0.1	100/1000	0.5	0.3% or ±0.25pF	10/100
	100	0.1	100/1000	0.5	0.3% or ±0.25pF	10/100
	50	0.1	100/1000	0.5	0.3% or ±0.25pF	10/100
	25	0.1	100/1000	0.5	0.3% or ±0.25pF	10/100
	16	0.1	100/1000	0.5	0.3% or ±0.25pF	10/100
X7R	200*	2.5	100/1000	3.0	±20%	10/100
	100	2.5	100/1000	3.0	±20%	10/100
	50	2.5	100/1000	3.0	±20%	10/100
	25	3.5	100/1000	5.0	±20%	10/100
	16	3.5	100/1000	5.0	±20%	10/100
	6.3/10	5.0	100/1000	7.5	±20%	10/100

* 200 Volt limits not currently included in EIA-198.

**PERFORMANCE CURVES
EFFECT OF FREQUENCY
(See SPICE models for specific ratings.)**

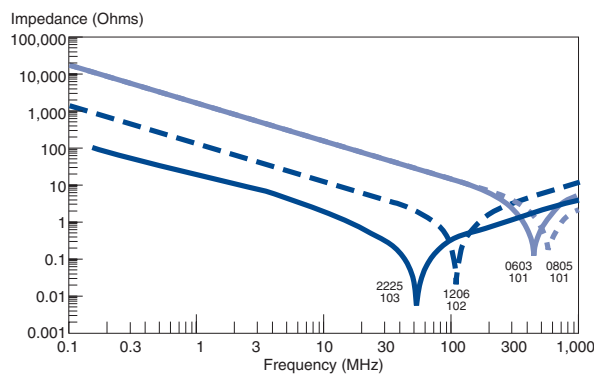

FIGURE 5. Impedance versus Frequency C0G Dielectric

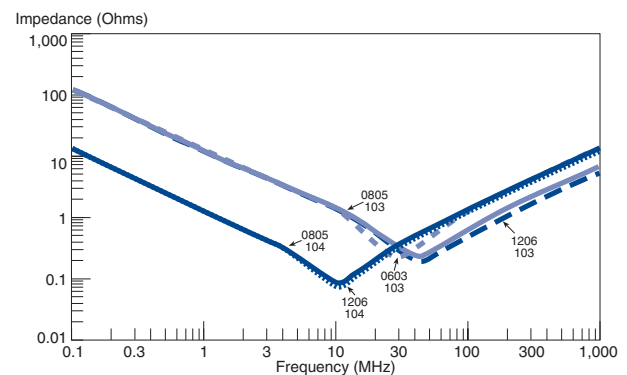
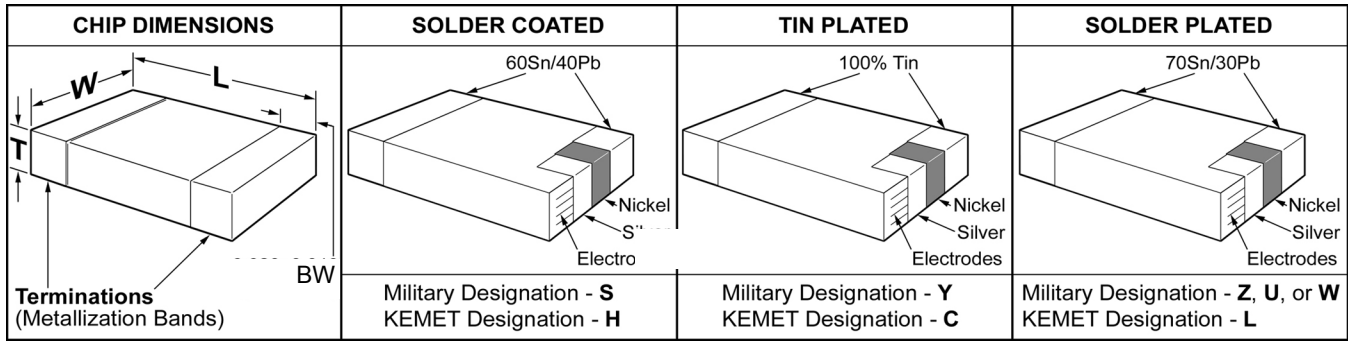

FIGURE 6. Impedance versus Frequency X7R Dielectric

CAPACITOR OUTLINE DRAWINGS



DIMENSIONS—MILLIMETERS AND (INCHES)

STYLE	KEMET SIZE CODE	L	W	T		BW
				MIN.	MAX.	
CDR01	C0805	2.03 ±.38 (.080 ±.015)	1.27 ±.38 (.050 ±.015)	.56 (.022)	1.40 (.055)	.51 ± 0.25 (.020 ±.010)
CDR02	C1805	4.57 ±.38 (.180 ±.015)	1.27 ±.38 (.050 ±.015)	.56 (.022)	1.40 (.055)	.51 ± 0.25 (.020 ±.010)
CDR03	C1808	4.57 ±.38 (.180 ±.015)	2.03 ±.38 (.080 ±.015)	.56 (.022)	2.03 (.080)	.51 ± 0.25 (.020 ±.010)
CDR04	C1812	4.57 ±.38 (.180 ±.015)	3.18 ±.38 (.125 ±.015)	.56 (.022)	2.03 (.080)	.51 ± 0.25 (.020 ±.010)
CDR05	C1825	4.57 $\left(\begin{smallmatrix} +.51 \\ .180 \\ -.38 \end{smallmatrix} \right)$ $\left(\begin{smallmatrix} +.020 \\ -.015 \end{smallmatrix} \right)$	6.35 $\left(\begin{smallmatrix} +.51 \\ .250 \\ -.38 \end{smallmatrix} \right)$ $\left(\begin{smallmatrix} +.020 \\ -.015 \end{smallmatrix} \right)$.51 (.020)	2.03 (.080)	.51 ± 0.25 (.020 ±.010)
CDR06	C2225	5.72 ±.51 (.225 ±.020)	6.35 ±.51 (.250 ±.020)	.51 (.020)	2.03 (.080)	.51 ± 0.25 (.020 ±.010)
CDR31	C0805	2.00 ±.20 (.078 ±.008)	1.25 ±.20 (.049 ±.008)		1.30 (.051)	.50 ± 0.20 (.020 ±.008)
CDR32	C1206	3.20 ±.20 (.125 ±.008)	1.60 ±.20 (.062 ±.008)		1.30 (.051)	.50 ± 0.20 (.020 ±.008)
CDR33	C1210	3.20 ±.25 (.125 ±.010)	2.50 ±.25 (.098 ±.010)		1.50 (.059)	.50 ± 0.25 (.020 ±.010)
CDR34	C1812	4.50 ±.25 (.176 ±.010)	3.20 ±.25 (.125 ±.010)		1.50 (.059)	.50 ± 0.25 (.020 ±.010)
CDR35	C1825	4.50 ±.30 (.176 ±.012)	6.40 ±.30 (.250 ±.012)		1.50 (.059)	.50 ± 0.30 (.020 ±.012)

Note: For MIL-C55681 "S" Endmet, the length, width and thickness positive tolerances (including bandwidth) cited above are allowed to increase by the following amounts:

	Length	Width
CDR01	0.51MM (.020)	0.38MM (.015)
CDR02-06	0.64MM (.025)	0.38MM (.015)
CDR31-35	0.60MM (.023)	0.30MM (.012)

MIL-PRF-55681 PART NUMBER ORDERING INFORMATION

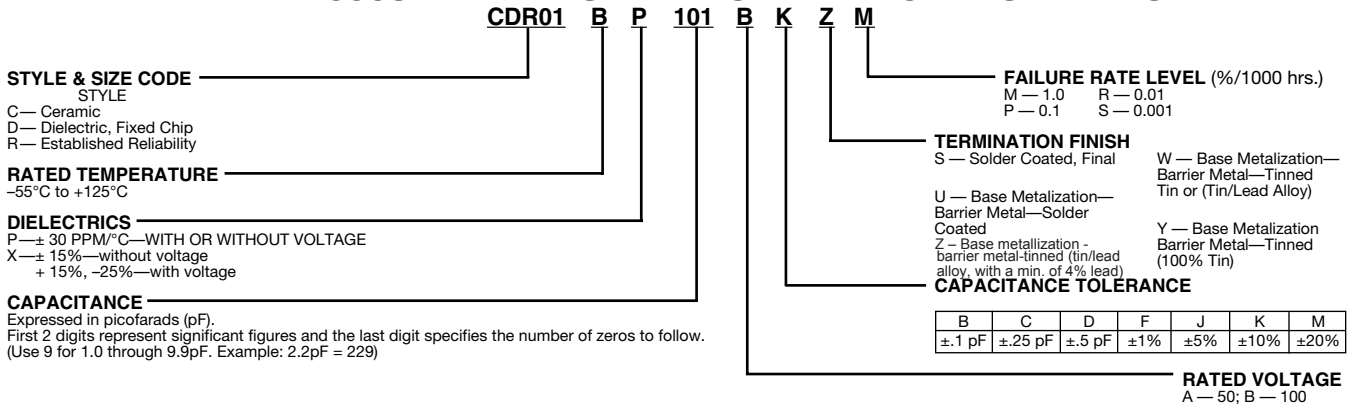

KEMET/MIL-PRF-55681 PART NUMBER EQUIVALENTS

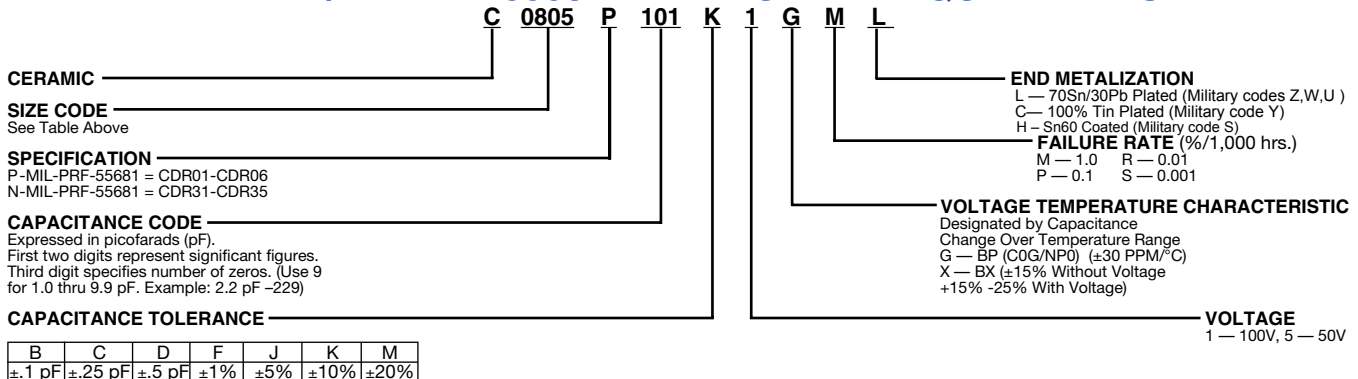

Part Number Example: C0805P101K1GML (14 digits - no spaces)

©KEMET Electronics Corporation, P.O. Box 5928, Greenville, S.C. 29606, (864) 963-6300

RATINGS & PART NUMBER REFERENCE

Characteristics	Cap pF	Avail. Tol.	KEMET Part Number	MIL-PRF-55681 Part Number
100 Volt - C0805 Size (Military CDR01)				
BP	10	J,K	C0805P100(3)1G(4)L	CDR01BP100B(3)Z(4)
	12	J	C0805P120J1G(4)L	CDR01BP120BJZ(4)
	15	J,K	C0805P150(3)1G(4)L	CDR01BP150B(3)Z(4)
	18	J	C0805P180J1G(4)L	CDR01BP180BJZ(4)
	22	J,K	C0805P220(3)1G(4)L	CDR01BP220B(3)Z(4)
	27	J	C0805P270J1G(4)L	CDR01BP270BJZ(4)
	33	J,K	C0805P330(3)1G(4)L	CDR01BP330B(3)Z(4)
	39	J	C0805P390J1G(4)L	CDR01BP390BJZ(4)
	47	J,K	C0805P470(3)1G(4)L	CDR01BP470B(3)Z(4)
	56	J	C0805P560J1G(4)L	CDR01BP560BJZ(4)
	68	J,K	C0805P680(3)1G(4)L	CDR01BP680B(3)Z(4)
	82	J	C0805P820J1G(4)L	CDR01BP820BJZ(4)
	100	J,K	C0805P101(3)1G(4)L	CDR01BP101B(3)Z(4)
	BP or BX	120	J,K	C0805P121(3)1(2)(4)L
150		J,K	C0805P151(3)1(2)(4)L	CDR01B(1)151B(3)Z(4)
180		J,K	C0805P181(3)1(2)(4)L	CDR01B(1)181B(3)Z(4)
BX	220	K,M	C0805P221(3)1X(4)L	CDR01BX221B(3)Z(4)
	270	K	C0805P271K1X(4)L	CDR01BX271BKZ(4)
	330	K,M	C0805P331(3)1X(4)L	CDR01BX331B(3)Z(4)
	390	K	C0805P391K1X(4)L	CDR01BX391BKZ(4)
	470	K,M	C0805P471(3)1X(4)L	CDR01BX471B(3)Z(4)
	560	K	C0805P561K1X(4)L	CDR01BX561BKZ(4)
	680	K,M	C0805P681(3)1X(4)L	CDR01BX681B(3)Z(4)
	820	K	C0805P821K1X(4)L	CDR01BX821BKZ(4)
	1,000	K,M	C0805P102(3)1X(4)L	CDR01BX102B(3)Z(4)
	1,200	K	C0805P122K1X(4)L	CDR01BX122BKZ(4)
	1,500	K,M	C0805P152(3)1X(4)L	CDR01BX152B(3)Z(4)
	1,800	K	C0805P182K1X(4)L	CDR01BX182BKZ(4)
	2,200	K,M	C0805P222(3)1X(4)L	CDR01BX222B(3)Z(4)
	2,700	K	C0805P272K1X(4)L	CDR01BX272BKZ(4)
3,300	K,M	C0805P332(3)1X(4)L	CDR01BX332B(3)Z(4)	
50 Volt - C0805 Size (Military CDR01)				
BX	3,900	K	C0805P392K5X(4)L	CDR01BX392AKZ(4)
	4,700	K,M	C0805P472(3)5X(4)L	CDR01BX472A(3)Z(4)
100 Volt - C1805 Size (Military CDR02)				
BP	220	J,K	C1805P221(3)1G(4)L	CDR02BP221B(3)Z(4)
	270	J	C1805P271J1G(4)L	CDR02BP271BJZ(4)
BX	3,900	K	C1805P392K1X(4)L	CDR02BX392BKZ(4)
	4,700	K,M	C1805P472(3)1X(4)L	CDR02BX472B(3)Z(4)
	5,600	K	C1805P562K1X(4)L	CDR02BX562BKZ(4)
	6,800	K,M	C1805P682(3)1X(4)L	CDR02BX682B(3)Z(4)
	8,200	K	C1805P822K1X(4)L	CDR02BX822BKZ(4)
	10,000	K,M	C1805P103(3)1X(4)L	CDR02BX103B(3)Z(4)
50 Volt - C1805 Size (Military CDR02)				
BX	12,000	K	C1805P123K5X(4)L	CDR02BX123AKZ(4)
	15,000	K,M	C1805P153(3)5X(4)L	CDR02BX153A(3)Z(4)
	18,000	K	C1805P183K5X(4)L	CDR02BX183AKZ(4)
	22,000	K,M	C1805P223(3)5X(4)L	CDR02BX223A(3)Z(4)
100 Volt - C1808 Size (Military CDR03)				
BP	330	J,K	C1808P331(3)1G(4)L	CDR03BP331B(3)Z(4)
	390	J	C1808P391J1G(4)L	CDR03BP391BJZ(4)
	470	J,K	C1808P471(3)1G(4)L	CDR03BP471B(3)Z(4)

Characteristics	Cap pF	Avail. Tol.	KEMET Part Number	MIL-PRF-55681 Part Number
100 Volt - C1808 Size (Military CDR03) cont.				
BP	560	J	C1808P561J1G(4)L	CDR03BP561BJZ(4)
	680	J,K	C1808P681(3)1G(4)L	CDR03BP681B(3)Z(4)
	820	J	C1808P821J1G(4)L	CDR03BP821BJZ(4)
	1,000	J,K	C1808P102(3)1G(4)L	CDR03BP102B(3)Z(4)
BX	12,000	K	C1808P123K1X(4)L	CDR03BX123BKZ(4)
	15,000	K,M	C1808P153(3)1X(4)L	CDR03BX153B(3)Z(4)
	18,000	K	C1808P183K1X(4)L	CDR03BX183BKZ(4)
	22,000	K,M	C1808P223(3)1X(4)L	CDR03BX223B(3)Z(4)
	27,000	K	C1808P273K1X(4)L	CDR03BX273BKZ(4)
	33,000	K,M	C1808P333(3)1X(4)L	CDR03BX333B(3)Z(4)
50 Volt - C1808 Size (Military CDR03)				
BX	39,000	K	C1808P393K5X(4)L	CDR03BX393AKZ(4)
	47,000	K,M	C1808P473(3)5X(4)L	CDR03BX473A(3)Z(4)
	56,000	K	C1808P563K5X(4)L	CDR03BX563AKZ(4)
	68,000	K,M	C1808P683(3)5X(4)L	CDR03BX683A(3)Z(4)
100 Volt - C1812 Size (Military CDR04)				
BP	1,200	J	C1812P122J1G(4)L	CDR04BP122BJZ(4)
	1,500	J,K	C1812P152(3)1G(4)L	CDR04BP152B(3)Z(4)
	1,800	J	C1812P182J1G(4)L	CDR04BP182BJZ(4)
	2,200	J,K	C1812P222(3)1G(4)L	CDR04BP222B(3)Z(4)
	2,700	J	C1812P272J1G(4)L	CDR04BP272BJZ(4)
	3,300	J,K	C1812P332(3)1G(4)L	CDR04BP332B(3)Z(4)
BX	39,000	K	C1812P393K1X(4)L	CDR04BX393BKZ(4)
	47,000	K,M	C1812P473(3)1X(4)L	CDR04BX473B(3)Z(4)
	56,000	K	C1812P563K1X(4)L	CDR04BX563BKZ(4)
50 Volt - C1812 Size (Military CDR04)				
BX	82,000	K	C1812P823K5X(4)L	CDR04BX823AKZ(4)
	100,000	K,M	C1812P104(3)5X(4)L	CDR04BX104A(3)Z(4)
	120,000	K	C1812P124K5X(4)L	CDR04BX124AKZ(4)
	150,000	K,M	C1812P154(3)5X(4)L	CDR04BX154A(3)Z(4)
	180,000	K	C1812P184K5X(4)L	CDR04BX184AKZ(4)
100 Volt - C1825 Size (Military CDR05)				
BP	3,900	J,K	C1825P392(3)1G(4)L	CDR05BP392B(3)Z(4)
	4,700	J,K	C1825P472(3)1G(4)L	CDR05BP472B(3)Z(4)
	5,600	J,K	C1825P562(3)1G(4)L	CDR05BP562B(3)Z(4)
BX	68,000	K,M	C1825P683(3)1X(4)L	CDR05BX683B(3)Z(4)
	82,000	K	C1825P823K1X(4)L	CDR05BX823BKZ(4)
	100,000	K,M	C1825P104(3)1X(4)L	CDR05BX104B(3)Z(4)
	120,000	K	C1825P124K1X(4)L	CDR05BX124BKZ(4)
	150,000	K,M	C1825P154(3)1X(4)L	CDR05BX154B(3)Z(4)
50 Volt - C1825 Size (Military CDR05)				
BX	220,000	K,M	C1825P224(3)5X(4)L	CDR05BX224A(3)Z(4)
	270,000	K	C1825P274K5X(4)L	CDR05BX274AKZ(4)
	330,000	K,M	C1825P334(3)5X(4)L	CDR05BX334A(3)Z(4)
100 Volt - C2225 Size (Military CDR06)				
BP	6,800	J,K	C2225P682(3)1G(4)L	CDR06BP682B(3)Z(4)
	8,200	J,K	C2225P822(3)1G(4)L	CDR06BP822B(3)Z(4)
	10,000	J,K	C2225P103(3)1G(4)L	CDR06BP103B(3)Z(4)
50 Volt - C2225 Size (Military CDR06)				
BX	390,000	K	C2225P394K5X(4)L	CDR06BX394AKZ(4)
	470,000	K,M	C2225P474(3)5X(4)L	CDR06BX474A(3)Z(4)

- To complete Part Number for Dielectric, insert P or X symbol – as defined by Military specification.
- To complete Part number for Dielectric, insert G or X symbol. ("G" for Military "BP", or "X" for Military "BX.")
- To complete Part Number, insert Capacitance Tolerance symbol (when applicable) as available in MIL-PRF-55681: B – ±0.1pF, C – ±0.25pF, D – ±0.5pF, F – ±1%, J – ±5%, K – ±10%, M – ±20%. **NOTE: Available tolerances are listed in columns above.**
- To complete Part Number, insert Failure Rate symbol: M – 1.0%; P – 0.1%, R – 0.01%; S – 0.001%.

Note: All MIL_PRF-55681 and KEMET Part Numbers tabulated above assume the use of MIL-PRF-55681 "Z", KEMET "L" end metalization. If MIL-PRF-55681 "U", "W" (KEMET "L") or MIL-PRF-55681 "S" (KEMET "H") or MIL-PRF-55681 "Y" (KEMET "C") is required, please change designators accordingly.

MARKING

See page 97 for MIL-PRF-55681 Marking.

RATINGS & PART NUMBER REFERENCE

Cap pF	Avail. Tol.	KEMET Part Number	MIL-PRF-55681 Part Number
100 Volt - BP - C0805 Size (Military CDR31)			
1.0	B,C	C0805N109(3)1G(4)L	CDR31BP1R0B(3)Z(4)
1.1	B,C	C0805N119(3)1G(4)L	CDR31BP1R1B(3)Z(4)
1.2	B,C	C0805C129(3)1G(4)L	CDR31BP1R2B(3)Z(4)
1.3	B,C	C0805N139(3)1G(4)L	CDR31BP1R3B(3)Z(4)
1.5	B,C	C0805N159(3)1G(4)L	CDR31BP1R5B(3)Z(4)
1.6	B,C	C0805N169(3)1G(4)L	CDR31BP1R6B(3)Z(4)
1.8	B,C	C0805N189(3)1G(4)L	CDR31BP1R8B(3)Z(4)
2.0	B,C	C0805N209(3)1G(4)L	CDR31BP2R0B(3)Z(4)
2.2	B,C	C0805N229(3)1G(4)L	CDR31BP2R2B(3)Z(4)
2.4	B,C	C0805N249(3)1G(4)L	CDR31BP2R4B(3)Z(4)
2.7	B,C,D	C0805N279(3)1G(4)L	CDR31BP2R7B(3)Z(4)
3.0	B,C,D	C0805N309(3)1G(4)L	CDR31BP3R0B(3)Z(4)
3.3	B,C,D	C0805N339(3)1G(4)L	CDR31BP3R3B(3)Z(4)
3.6	B,C,D	C0805N369(3)1G(4)L	CDR31BP3R6B(3)Z(4)
3.9	B,C,D	C0805N399(3)1G(4)L	CDR31BP3R9B(3)Z(4)
4.3	B,C,D	C0805N439(3)1G(4)L	CDR31BP4R3B(3)Z(4)
4.7	B,C,D	C0805N479(3)1G(4)L	CDR31BP4R7B(3)Z(4)
5.1	B,C,D	C0805N519(3)1G(4)L	CDR31BP5R1B(3)Z(4)
5.6	B,C,D	C0805N569(3)1G(4)L	CDR31BP5R6B(3)Z(4)
6.2	B,C,D	C0805N629(3)1G(4)L	CDR31BP6R2B(3)Z(4)
6.8	B,C,D	C0805N689(3)1G(4)L	CDR31BP6R8B(3)Z(4)
7.5	B,C,D	C0805N759(3)1G(4)L	CDR31BP7R5B(3)Z(4)
8.2	B,C,D	C0805N829(3)1G(4)L	CDR31BP8R2B(3)Z(4)
9.1	B,C,D	C0805N919(3)1G(4)L	CDR31BP9R1B(3)Z(4)
10	F,J,K	C0805N100(3)1G(4)L	CDR31BP100B(3)Z(4)
11	F,J,K	C0805N110(3)1G(4)L	CDR31BP110B(3)Z(4)
12	F,J,K	C0805N120(3)1G(4)L	CDR31BP120B(3)Z(4)
13	F,J,K	C0805N130(3)1G(4)L	CDR31BP130B(3)Z(4)
15	F,J,K	C0805N150(3)1G(4)L	CDR31BP150B(3)Z(4)
16	F,J,K	C0805N160(3)1G(4)L	CDR31BP160B(3)Z(4)
18	F,J,K	C0805N180(3)1G(4)L	CDR31BP180B(3)Z(4)
20	F,J,K	C0805N200(3)1G(4)L	CDR31BP200B(3)Z(4)
22	F,J,K	C0805N220(3)1G(4)L	CDR31BP220B(3)Z(4)
24	F,J,K	C0805N240(3)1G(4)L	CDR31BP240B(3)Z(4)
27	F,J,K	C0805N270(3)1G(4)L	CDR31BP270B(3)Z(4)
30	F,J,K	C0805N300(3)1G(4)L	CDR31BP300B(3)Z(4)
33	F,J,K	C0805N330(3)1G(4)L	CDR31BP330B(3)Z(4)
36	F,J,K	C0805N360(3)1G(4)L	CDR31BP360B(3)Z(4)
39	F,J,K	C0805N390(3)1G(4)L	CDR31BP390B(3)Z(4)
43	F,J,K	C0805N430(3)1G(4)L	CDR31BP430B(3)Z(4)
47	F,J,K	C0805N470(3)1G(4)L	CDR31BP470B(3)Z(4)
51	F,J,K	C0805N510(3)1G(4)L	CDR31BP510B(3)Z(4)
56	F,J,K	C0805N560(3)1G(4)L	CDR31BP560B(3)Z(4)
62	F,J,K	C0805N620(3)1G(4)L	CDR31BP620B(3)Z(4)
68	F,J,K	C0805N680(3)1G(4)L	CDR31BP680B(3)Z(4)
75	F,J,K	C0805N750(3)1G(4)L	CDR31BP750B(3)Z(4)
82	F,J,K	C0805N820(3)1G(4)L	CDR31BP820B(3)Z(4)

Cap pF	Avail. Tol.	KEMET Part Number	MIL-PRF-55681 Part Number
100 Volt - BP - C0805 Size (Military CDR31)			
91	F,J,K	C0805N910(3)1G(4)L	CDR31BP910B(3)Z(4)
100	F,J,K	C0805N101(3)1G(4)L	CDR31BP101B(3)Z(4)
110	F,J,K	C0805N111(3)1G(4)L	CDR31BP111B(3)Z(4)
120	F,J,K	C0805N121(3)1G(4)L	CDR31BP121B(3)Z(4)
130	F,J,K	C0805N131(3)1G(4)L	CDR31BP131B(3)Z(4)
150	F,J,K	C0805N151(3)1G(4)L	CDR31BP151B(3)Z(4)
160	F,J,K	C0805N161(3)1G(4)L	CDR31BP161B(3)Z(4)
180	F,J,K	C0805N181(3)1G(4)L	CDR31BP181B(3)Z(4)
200	F,J,K	C0805N201(3)1G(4)L	CDR31BP201B(3)Z(4)
220	F,J,K	C0805N221(3)1G(4)L	CDR31BP221B(3)Z(4)
240	F,J,K	C0805N241(3)1G(4)L	CDR31BP241B(3)Z(4)
270	F,J,K	C0805N271(3)1G(4)L	CDR31BP271B(3)Z(4)
300	F,J,K	C0805N301(3)1G(4)L	CDR31BP301B(3)Z(4)
330	F,J,K	C0805N331(3)1G(4)L	CDR31BP331B(3)Z(4)
360	F,J,K	C0805N361(3)1G(4)L	CDR31BP361B(3)Z(4)
390	F,J,K	C0805N391(3)1G(4)L	CDR31BP391B(3)Z(4)
430	F,J,K	C0805N431(3)1G(4)L	CDR31BP431B(3)Z(4)
470	F,J,K	C0805N471(3)1G(4)L	CDR31BP471B(3)Z(4)
50 Volt - BP - C0805 Size (Military CDR31)			
510	F,J,K	C0805N511(3)5G(4)L	CDR31BP511A(3)Z(4)
560	F,J,K	C0805N561(3)5G(4)L	CDR31BP561A(3)Z(4)
620	F,J,K	C0805N621(3)5G(4)L	CDR31BP621A(3)Z(4)
680	F,J,K	C0805N681(3)5G(4)L	CDR31BP681A(3)Z(4)
100 Volt - BX - C0805 Size (Military CDR31)			
470	K,M	C0805N471(3)1X(4)L	CDR31BX471B(3)Z(4)
560	K,M	C0805N561(3)1X(4)L	CDR31BX561B(3)Z(4)
680	K,M	C0805N681(3)1X(4)L	CDR31BX681B(3)Z(4)
820	K,M	C0805N821(3)1X(4)L	CDR31BX821B(3)Z(4)
1,000	K,M	C0805N102(3)1X(4)L	CDR31BX102B(3)Z(4)
1,200	K,M	C0805N122(3)1X(4)L	CDR31BX122B(3)Z(4)
1,500	K,M	C0805N152(3)1X(4)L	CDR31BX152B(3)Z(4)
1,800	K,M	C0805N182(3)1X(4)L	CDR31BX182B(3)Z(4)
2,200	K,M	C0805N222(3)1X(4)L	CDR31BX222B(3)Z(4)
2,700	K,M	C0805N272(3)1X(4)L	CDR31BX272B(3)Z(4)
3,300	K,M	C0805N332(3)1X(4)L	CDR31BX332B(3)Z(4)
3,900	K,M	C0805N392(3)1X(4)L	CDR31BX392B(3)Z(4)
4,700	K,M	C0805N472(3)1X(4)L	CDR31BX472B(3)Z(4)
50 Volt - BX - C0805 Size (Military CDR31)			
5,600	K,M	C0805N562(3)5X(4)L	CDR31BX562A(3)Z(4)
6,800	K,M	C0805N682(3)5X(4)L	CDR31BX682A(3)Z(4)
8,200	K,M	C0805N822(3)5X(4)L	CDR31BX822A(3)Z(4)
10,000	K,M	C0805N103(3)5X(4)L	CDR31BX103A(3)Z(4)
12,000	K,M	C0805N123(3)5X(4)L	CDR31BX123A(3)Z(4)
15,000	K,M	C0805N153(3)5X(4)L	CDR31BX153A(3)Z(4)
18,000	K,M	C0805N183(3)5X(4)L	CDR31BX183A(3)Z(4)

- To complete Part Number for Dielectric, insert P or X symbol – as defined by Military specification.
- To complete Part number for Dielectric, insert G or X symbol. ("G" for Military "BP", or "X" for Military "BX".)
- To complete Part Number, insert Capacitance Tolerance symbol (when applicable) as available in MIL-PRF-55681: B – ±0.1pF, C – ±0.25pF, D – ±0.5pF, F – ±1%, J – ±5%, K – ±10%, M – ±20%. **NOTE: Available tolerances are listed in columns above.**
- To complete Part Number, insert Failure Rate symbol: M – 1.0%; P – 0.1%, R – 0.01%; S – 0.001%.

Note: All MIL-PRF-55681 and KEMET Part Numbers tabulated above assume the use of MIL-PRF-55681 "Z", KEMET "L" end metalization. If MIL-PRF-55681 "U", "W" (KEMET "L") or MIL-PRF-55681 "S" (KEMET "H") or MIL-PRF-55681 "Y" (KEMET "C") is required, please change designators accordingly.

MARKING

See page 97 for MIL-PRF-55681 Marking.

RATINGS & PART NUMBER REFERENCE

Cap pF	Avail. Tol.	KEMET Part Number	MIL-PRF-55681 Part Number
100 Volt - BP - C1206 Size (Military CDR32)			
1.0	B,C	C1206N109(3)1G(4)L	CDR32BP1R0B(3)Z(4)
1.1	B,C	C1206N119(3)1G(4)L	CDR32BP1R1B(3)Z(4)
1.2	B,C	C1206C129(3)1G(4)L	CDR32BP1R2B(3)Z(4)
1.3	B,C	C1206N139(3)1G(4)L	CDR32BP1R3B(3)Z(4)
1.5	B,C	C1206N159(3)1G(4)L	CDR32BP1R5B(3)Z(4)
1.6	B,C	C1206N169(3)1G(4)L	CDR32BP1R6B(3)Z(4)
1.8	B,C	C1206N189(3)1G(4)L	CDR32BP1R8B(3)Z(4)
2.0	B,C	C1206N209(3)1G(4)L	CDR32BP2R0B(3)Z(4)
2.2	B,C	C1206N229(3)1G(4)L	CDR32BP2R2B(3)Z(4)
2.4	B,C	C1206N249(3)1G(4)L	CDR32BP2R4B(3)Z(4)
2.7	B,C,D	C1206N279(3)1G(4)L	CDR32BP2R7B(3)Z(4)
3.0	B,C,D	C1206N309(3)1G(4)L	CDR32BP3R0B(3)Z(4)
3.3	B,C,D	C1206N339(3)1G(4)L	CDR32BP3R3B(3)Z(4)
3.6	B,C,D	C1206N369(3)1G(4)L	CDR32BP3R6B(3)Z(4)
3.9	B,C,D	C1206N399(3)1G(4)L	CDR32BP3R9B(3)Z(4)
4.3	B,C,D	C1206N439(3)1G(4)L	CDR32BP4R3B(3)Z(4)
4.7	B,C,D	C1206N479(3)1G(4)L	CDR32BP4R7B(3)Z(4)
5.1	B,C,D	C1206N519(3)1G(4)L	CDR32BP5R1B(3)Z(4)
5.6	B,C,D	C1206N569(3)1G(4)L	CDR32BP5R6B(3)Z(4)
6.2	B,C,D	C1206N629(3)1G(4)L	CDR32BP6R2B(3)Z(4)
6.8	B,C,D	C1206N689(3)1G(4)L	CDR32BP6R8B(3)Z(4)
7.5	B,C,D	C1206N759(3)1G(4)L	CDR32BP7R5B(3)Z(4)
8.2	B,C,D	C1206N829(3)1G(4)L	CDR32BP8R2B(3)Z(4)
9.1	B,C,D	C1206N919(3)1G(4)L	CDR32BP9R1B(3)Z(4)
10	F,J,K	C1206N100(3)1G(4)L	CDR32BP100B(3)Z(4)
11	F,J,K	C1206N110(3)1G(4)L	CDR32BP110B(3)Z(4)
12	F,J,K	C1206N120(3)1G(4)L	CDR32BP120B(3)Z(4)
13	F,J,K	C1206N130(3)1G(4)L	CDR32BP130B(3)Z(4)
15	F,J,K	C1206N150(3)1G(4)L	CDR32BP150B(3)Z(4)
16	F,J,K	C1206N160(3)1G(4)L	CDR32BP160B(3)Z(4)
18	F,J,K	C1206N180(3)1G(4)L	CDR32BP180B(3)Z(4)
20	F,J,K	C1206N200(3)1G(4)L	CDR32BP200B(3)Z(4)
22	F,J,K	C1206N220(3)1G(4)L	CDR32BP220B(3)Z(4)
24	F,J,K	C1206N240(3)1G(4)L	CDR32BP240B(3)Z(4)
27	F,J,K	C1206N270(3)1G(4)L	CDR32BP270B(3)Z(4)
30	F,J,K	C1206N300(3)1G(4)L	CDR32BP300B(3)Z(4)
33	F,J,K	C1206N330(3)1G(4)L	CDR32BP330B(3)Z(4)
36	F,J,K	C1206N360(3)1G(4)L	CDR32BP360B(3)Z(4)
39	F,J,K	C1206N390(3)1G(4)L	CDR32BP390B(3)Z(4)
43	F,J,K	C1206N430(3)1G(4)L	CDR32BP430B(3)Z(4)
47	F,J,K	C1206N470(3)1G(4)L	CDR32BP470B(3)Z(4)
51	F,J,K	C1206N510(3)1G(4)L	CDR32BP510B(3)Z(4)
56	F,J,K	C1206N560(3)1G(4)L	CDR32BP560B(3)Z(4)
62	F,J,K	C1206N620(3)1G(4)L	CDR32BP620B(3)Z(4)
68	F,J,K	C1206N680(3)1G(4)L	CDR32BP680B(3)Z(4)
75	F,J,K	C1206N750(3)1G(4)L	CDR32BP750B(3)Z(4)
82	F,J,K	C1206N820(3)1G(4)L	CDR32BP820B(3)Z(4)
91	F,J,K	C1206N910(3)1G(4)L	CDR32BP910B(3)Z(4)
100	F,J,K	C1206N101(3)1G(4)L	CDR32BP101B(3)Z(4)

Cap pF	Avail. Tol.	KEMET Part Number	MIL-PRF-55681 Part Number
100 Volt - BP - C1206 Size (Military CDR32)			
110	F,J,K	C1206N111(3)1G(4)L	CDR32BP111B(3)Z(4)
120	F,J,K	C1206N121(3)1G(4)L	CDR32BP121B(3)Z(4)
130	F,J,K	C1206N131(3)1G(4)L	CDR32BP131B(3)Z(4)
150	F,J,K	C1206N151(3)1G(4)L	CDR32BP151B(3)Z(4)
160	F,J,K	C1206N161(3)1G(4)L	CDR32BP161B(3)Z(4)
180	F,J,K	C1206N181(3)1G(4)L	CDR32BP181B(3)Z(4)
200	F,J,K	C1206N201(3)1G(4)L	CDR32BP201B(3)Z(4)
220	F,J,K	C1206N221(3)1G(4)L	CDR32BP221B(3)Z(4)
240	F,J,K	C1206N241(3)1G(4)L	CDR32BP241B(3)Z(4)
270	F,J,K	C1206N271(3)1G(4)L	CDR32BP271B(3)Z(4)
300	F,J,K	C1206N301(3)1G(4)L	CDR32BP301B(3)Z(4)
330	F,J,K	C1206N331(3)1G(4)L	CDR32BP331B(3)Z(4)
360	F,J,K	C1206N361(3)1G(4)L	CDR32BP361B(3)Z(4)
390	F,J,K	C1206N391(3)1G(4)L	CDR32BP391B(3)Z(4)
430	F,J,K	C1206N431(3)1G(4)L	CDR32BP431B(3)Z(4)
470	F,J,K	C1206N471(3)1G(4)L	CDR32BP471B(3)Z(4)
510	F,J,K	C1206N511(3)1G(4)L	CDR32BP511B(3)Z(4)
560	F,J,K	C1206N561(3)1G(4)L	CDR32BP561B(3)Z(4)
620	F,J,K	C1206N621(3)1G(4)L	CDR32BP621B(3)Z(4)
680	F,J,K	C1206N681(3)1G(4)L	CDR32BP681B(3)Z(4)
750	F,J,K	C1206N751(3)1G(4)L	CDR32BP751B(3)Z(4)
820	F,J,K	C1206N821(3)1G(4)L	CDR32BP821B(3)Z(4)
910	F,J,K	C1206N911(3)1G(4)L	CDR32BP911B(3)Z(4)
1,000	F,J,K	C1206N102(3)1G(4)L	CDR32BP102B(3)Z(4)
50 Volt - BP - C1206 Size (Military CDR32)			
1,100	F,J,K	C1206N112(3)5G(4)L	CDR32BP112A(3)Z(4)
1,200	F,J,K	C1206N122(3)5G(4)L	CDR32BP122A(3)Z(4)
1,300	F,J,K	C1206N132(3)5G(4)L	CDR32BP132A(3)Z(4)
1,500	F,J,K	C1206N152(3)5G(4)L	CDR32BP152A(3)Z(4)
1,600	F,J,K	C1206N162(3)5G(4)L	CDR32BP162A(3)Z(4)
1,800	F,J,K	C1206N182(3)5G(4)L	CDR32BP182A(3)Z(4)
2,000	F,J,K	C1206N202(3)5G(4)L	CDR32BP202A(3)Z(4)
2,200	F,J,K	C1206N222(3)5G(4)L	CDR32BP222A(3)Z(4)
100 Volt - BX - C1206 Size (Military CDR32)			
4,700	K,M	C1206N472(3)1X(4)L	CDR32BX472B(3)Z(4)
5,600	K,M	C1206N562(3)1X(4)L	CDR32BX562B(3)Z(4)
6,800	K,M	C1206N682(3)1X(4)L	CDR32BX682B(3)Z(4)
8,200	K,M	C1206N822(3)1X(4)L	CDR32BX822B(3)Z(4)
10,000	K,M	C1206N103(3)1X(4)L	CDR32BX103B(3)Z(4)
12,000	K,M	C1206N123(3)1X(4)L	CDR32BX123B(3)Z(4)
15,000	K,M	C1206N153(3)1X(4)L	CDR32BX153B(3)Z(4)
50 Volt - BX - C1206 Size (Military CDR32)			
18,000	K,M	C1206N183(3)5X(4)L	CDR32BX183A(3)Z(4)
22,000	K,M	C1206N223(3)5X(4)L	CDR32BX223A(3)Z(4)
27,000	K,M	C1206N273(3)5X(4)L	CDR32BX273A(3)Z(4)
33,000	K,M	C1206N333(3)5X(4)L	CDR32BX333A(3)Z(4)
39,000	K,M	C1206N393(3)5X(4)L	CDR32BX393A(3)Z(4)

- To complete Part Number for Dielectric, insert P or X symbol – as defined by Military specification.
- To complete Part number for Dielectric, insert G or X symbol. ("G" for Military "BP", or "X" for Military "BX.")
- To complete Part Number, insert Capacitance Tolerance symbol (when applicable) as available in MIL-PRF-55682: B – ±0.1pF, C – ±0.25pF, D – ±0.5pF, F – ±1%, J – ±5%, K – ±10%, M – ±20%. **NOTE: Available tolerances are listed in columns above.**
- To complete Part Number, insert Failure Rate symbol: M – 1.0%; P – 0.1%, R – 0.01%; S – 0.001%.

Note: All MIL-PRF-55681 and KEMET Part Numbers tabulated above assume the use of MIL-PRF-55681 "Z", KEMET "L" end metalization. If MIL-PRF-55681 "U", "W" (KEMET "L") or MIL-PRF-55681 "S" (KEMET "H") or MIL-PRF-55681 "Y" (KEMET "C") is required, please change designators accordingly.

MARKING

See page 97 for MIL-PRF-55681 Marking.

RATINGS & PART NUMBER REFERENCE

Cap pF	Avail. Tol.	KEMET Part Number	MIL-PRF-55681 Part Number	Cap pF	Avail. Tol.	KEMET Part Number	MIL-PRF-55681 Part Number
100 Volt - BP - C1210 Size (Military CDR33)				100 Volt - BX - C1812 Size (Military CDR34)			
1,000	F,J,K	C1210N102(3)1G(4)JL	CDR33BP102B(3)Z(4)	27,000	K,M	C1812N273(3)1X(4)L	CDR34BX273B(3)Z(4)
1,100	F,J,K	C1210N112(3)1G(4)JL	CDR33BP112B(3)Z(4)	33,000	K,M	C1812N333(3)1X(4)L	CDR34BX333B(3)Z(4)
1,200	F,J,K	C1210N122(3)1G(4)JL	CDR33BP122B(3)Z(4)	39,000	K,M	C1812N393(3)1X(4)L	CDR34BX393B(3)Z(4)
1,300	F,J,K	C1210N132(3)1G(4)JL	CDR33BP132B(3)Z(4)	47,000	K,M	C1812N473(3)1X(4)L	CDR34BX473B(3)Z(4)
1,500	F,J,K	C1210N152(3)1G(4)JL	CDR33BP152B(3)Z(4)	56,000	K,M	C1812N563(3)1X(4)L	CDR34BX563B(3)Z(4)
1,600	F,J,K	C1210N162(3)1G(4)JL	CDR33BP162B(3)Z(4)	50 Volt - BX - C1812 Size (Military CDR34)			
1,800	F,J,K	C1210N182(3)1G(4)JL	CDR33BP182B(3)Z(4)	100,000	K,M	C1812N104(3)5X(4)L	CDR34BX104A(3)Z(4)
2,000	F,J,K	C1210N202(3)1G(4)JL	CDR33BP202B(3)Z(4)	120,000	K,M	C1812N124(3)5X(4)L	CDR34BX124A(3)Z(4)
2,200	F,J,K	C1210N222(3)1G(4)JL	CDR33BP222B(3)Z(4)	150,000	K,M	C1812N154(3)5X(4)L	CDR34BX154A(3)Z(4)
50 Volt - BP - C1210 Size (Military CDR33)				180,000	K,M	C1812N184(3)5X(4)L	CDR34BX184A(3)Z(4)
2,400	F,J,K	C1210N242(3)5G(4)JL	CDR33BP242A(3)Z(4)	100 Volt - BP - C1825 Size (Military CDR35)			
2,700	F,J,K	C1210N272(3)5G(4)JL	CDR33BP272A(3)Z(4)	4,700	F,J,K	C1825N472(3)1G(4)L	CDR35BP472B(3)Z(4)
3,000	F,J,K	C1210N302(3)5G(4)JL	CDR33BP302A(3)Z(4)	5,100	F,J,K	C1825N512(3)1G(4)L	CDR35BP512B(3)Z(4)
3,300	F,J,K	C1210N332(3)5G(4)JL	CDR33BP332A(3)Z(4)	5,600	F,J,K	C1825N562(3)1G(4)L	CDR35BP562B(3)Z(4)
100 Volt - BX - C1210 Size (Military CDR33)				6,200	F,J,K	C1825N622(3)1G(4)L	CDR35BP622B(3)Z(4)
15,000	K,M	C1210N153(3)1X(4)L	CDR33BX153B(3)Z(4)	6,800	F,J,K	C1825N682(3)1G(4)L	CDR35BP682B(3)Z(4)
18,000	K,M	C1210N183(3)1X(4)L	CDR33BX183B(3)Z(4)	7,500	F,J,K	C1825N752(3)1G(4)L	CDR35BP752B(3)Z(4)
22,000	K,M	C1210N223(3)1X(4)L	CDR33BX223B(3)Z(4)	8,200	F,J,K	C1825N822(3)1G(4)L	CDR35BP822B(3)Z(4)
27,000	K,M	C1210N273(3)1X(4)L	CDR33BX273B(3)Z(4)	9,100	F,J,K	C1825N912(3)1G(4)L	CDR35BP912B(3)Z(4)
50 Volt - BX - C1210 Size (Military CDR33)				10,000	F,J,K	C1825N103(3)1G(4)L	CDR35BP103B(3)Z(4)
39,000	K,M	C1210N393(3)5X(4)L	CDR33BX393A(3)Z(4)	50 Volt - BP - C1825 Size (Military CDR35)			
47,000	K,M	C1210N473(3)5X(4)L	CDR33BX473A(3)Z(4)	11,000	F,J,K	C1825N113(3)5G(4)L	CDR35BP113A(3)Z(4)
56,000	K,M	C1210N563(3)5X(4)L	CDR33BX563A(3)Z(4)	12,000	F,J,K	C1825N123(3)5G(4)L	CDR35BP123A(3)Z(4)
68,000	K,M	C1210N683(3)5X(4)L	CDR33BX683A(3)Z(4)	13,000	F,J,K	C1825N133(3)5G(4)L	CDR35BP133A(3)Z(4)
82,000	K,M	C1210N823(3)5X(4)L	CDR33BX823A(3)Z(4)	15,000	F,J,K	C1825N153(3)5G(4)L	CDR35BP153A(3)Z(4)
100,000	K,M	C1210N104(3)5X(4)L	CDR33BX104A(3)Z(4)	16,000	F,J,K	C1825N163(3)5G(4)L	CDR35BP163A(3)Z(4)
100 Volt - BP - C1812 Size (Military CDR34)				18,000	F,J,K	C1825N183(3)5G(4)L	CDR35BP183A(3)Z(4)
2,200	F,J,K	C1812N222(3)1G(4)JL	CDR34BP222B(3)Z(4)	20,000	F,J,K	C1825N203(3)5G(4)L	CDR35BP203A(3)Z(4)
2,400	F,J,K	C1812N242(3)1G(4)JL	CDR34BP242B(3)Z(4)	22,000	F,J,K	C1825N223(3)5G(4)L	CDR35BP223A(3)Z(4)
2,700	F,J,K	C1812N272(3)1G(4)JL	CDR34BP272B(3)Z(4)	100 Volt - BX - C1825 Size (Military CDR35)			
3,000	F,J,K	C1812N322(3)1G(4)JL	CDR34BP302B(3)Z(4)	56,000	K,M	C1825N563(3)1X(4)L	CDR35BX563B(3)Z(4)
3,300	F,J,K	C1812N332(3)1G(4)JL	CDR34BP332B(3)Z(4)	68,000	K,M	C1825N683(3)1X(4)L	CDR35BX683B(3)Z(4)
3,600	F,J,K	C1812N362(3)1G(4)JL	CDR34BP362B(3)Z(4)	82,000	K,M	C1825N823(3)1X(4)L	CDR35BX823B(3)Z(4)
3,900	F,J,K	C1812N392(3)1G(4)JL	CDR34BP392B(3)Z(4)	100,000	K,M	C1825N104(3)1X(4)L	CDR35BX104B(3)Z(4)
4,300	F,J,K	C1812N432(3)1G(4)JL	CDR34BP432B(3)Z(4)	120,000	K,M	C1825N124(3)1X(4)L	CDR35BX124B(3)Z(4)
4,700	F,J,K	C1812N472(3)1G(4)JL	CDR34BP472B(3)Z(4)	150,000	K,M	C1825N154(3)1X(4)L	CDR35BX154B(3)Z(4)
50 Volt - BP - C1812 Size (Military CDR34)				50 Volt - BX - C1825 Size (Military CDR35)			
5,100	F,J,K	C1812N512(3)5G(4)JL	CDR34BP512A(3)Z(4)	180,000	K,M	C1825N184(3)5X(4)L	CDR35BX184A(3)Z(4)
5,600	F,J,K	C1812N562(3)5G(4)JL	CDR34BP562A(3)Z(4)	220,000	K,M	C1825N224(3)5X(4)L	CDR35BX224A(3)Z(4)
6,200	F,J,K	C1812N622(3)5G(4)JL	CDR34BP622A(3)Z(4)	270,000	K,M	C1825N274(3)5X(4)L	CDR35BX274A(3)Z(4)
6,800	F,J,K	C1812N682(3)5G(4)JL	CDR34BP682A(3)Z(4)	330,000	K,M	C1825N334(3)5X(4)L	CDR35BX334A(3)Z(4)
7,500	F,J,K	C1812N752(3)5G(4)JL	CDR34BP752A(3)Z(4)	390,000	K,M	C1825N394(3)5X(4)L	CDR35BX394A(3)Z(4)
8,200	F,J,K	C1812N822(3)5G(4)JL	CDR34BP822A(3)Z(4)	470,000	K,M	C1825N474(3)5X(4)L	CDR35BX474A(3)Z(4)
9,100	F,J,K	C1812N912(3)5G(4)JL	CDR34BP912A(3)Z(4)				
10,000	F,J,K	C1812N103(3)5G(4)JL	CDR34BP103A(3)Z(4)				

- To complete Part Number for Dielectric, insert P or X symbol – as defined by Military specification.
- To complete Part number for Dielectric, insert G or X symbol. ("G" for Military "BP", or "X" for Military "BX".)
- To complete Part Number, insert Capacitance Tolerance symbol (when applicable) as available in MIL-PRF-5682: B – ±0.1pF, C – ±0.25pF, D – ±0.5pF, F – ±1%, J – ±5%, K – ±10%, M – ±20%. **NOTE: Available tolerances are listed in columns above.**
- To complete Part Number, insert Failure Rate symbol: M – 1.0%; P – 0.1%, R – 0.01%; S – 0.001%.

Note: All MIL_PRF-55681 and KEMET Part Numbers tabulated above assume the use of MIL-PRF-55681 "Z", KEMET "L" end metalization. If MIL-PRF-55681 "U", "W" (KEMET "L") or MIL-PRF-55681 "S" (KEMET "H") or MIL-PRF-55681 "Y" (KEMET "C") is required, please change designators accordingly.

MARKING

See page 97 for MIL-PRF-55681 Marking.

MIL-PRF-55681 MAXIMUM INDIVIDUAL PACKAGING QUANTITIES

CHIP SIZE	REELED	BULK-STD BAG	BULK - ANTI-STATIC BAG	CHIP SIZE	REELED	BULK-STD BAG	BULK - ANTI-STATIC BAG
C0805	2,500	25,000	10,000	C1808	2,500	7,500	3,000
C1206	2,500	25,000	10,000	C1812	1,100	7,500	3,000
C1210	2,500	25,000	10,000	C1825	1,100	7,500	1,000
C1805	2,500	7,500	3,000	C2225	1,100	5,000	1,000

MIL-PRF-55681 chips available in 7" reels only.

Tape & Reel Packaging

KEMET offers Multilayer Ceramic Chip Capacitors packaged in 8mm and 12mm plastic tape on 7" and 13" reels in accordance with EIA standard 481-1: Taping of surface mount components for automatic handling. This packaging system is compatible with all tape fed automatic pick and place systems. See page 78 for details on reeling quantities for commercial chips and page 87 for MIL-PRF-55681 chips.

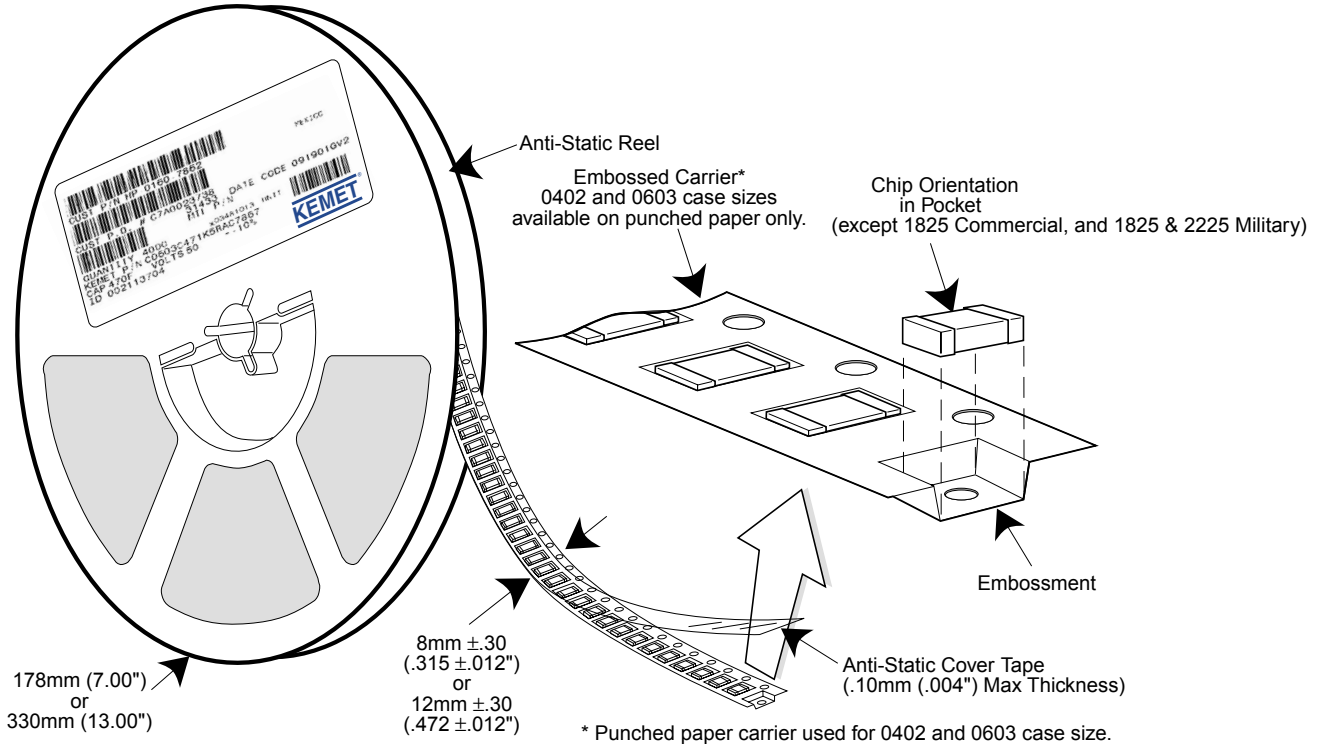

SURFACE MOUNT LAND DIMENSIONS - CERAMIC CHIP CAPACITORS - MM

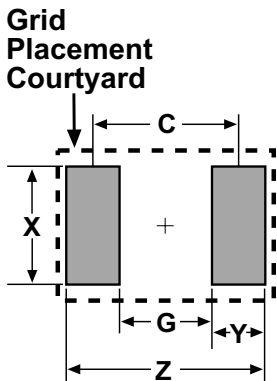

Dimension	Reflow Solder					Wave Solder				
	Z	G	X	Y(ref)	C(ref)	Z	G	X	Y(ref)	Smin
0402	2.14	0.28	0.74	0.93	1.21	Not Recommended				
0603	2.78	0.68	1.08	1.05	1.73	3.18	0.68	0.80	1.25	1.93
0805	3.30	0.70	1.60	1.30	2.00	3.70	0.70	1.10	1.50	2.20
1206	4.50	1.50	2.00	1.50	3.00	4.90	1.50	1.40	1.70	3.20
1210	4.50	1.50	2.90	1.50	3.00	4.90	1.50	2.00	1.70	3.20
1812	5.90	2.30	3.70	1.80	4.10	Not Recommended				
1825	5.90	2.30	6.90	1.80	4.10					
2220	7.00	3.30	5.50	1.85	5.15					
2225	7.00	3.30	6.80	1.85	5.15					

Calculation Formula
 $Z = L_{min} + 2J_t + T_t$
 $G = S_{max} - 2J_h - T_h$
 $X = W_{min} + 2J_s + T_s$
 $T_t, T_h, T_s = \text{Combined tolerances}$

TANTALUM, CERAMIC AND ALUMINUM CHIP CAPACITORS

Packaging Information

Performance Notes

- Cover Tape Break Force:** 1.0 Kg Minimum.
- Cover Tape Peel Strength:** The total peel strength of the cover tape from the carrier tape shall be:

Tape Width	Peel Strength
8 mm	0.1 Newton to 1.0 Newton (10g to 100g)
12 mm	0.1 Newton to 1.3 Newton (10g to 130g)

The direction of the pull shall be opposite the direction of the carrier tape travel. The pull angle of the carrier tape shall be 165° to 180° from the plane of the carrier tape. During peeling, the carrier and/or cover tape shall be pulled at a velocity of 300 ±10 mm/minute.

- Reel Sizes:** Molded tantalum capacitors are available on either 180 mm (7") reels (standard) or 330 mm (13") reels (with C-7280). Note that 13" reels are preferred.
- Labeling:** Bar code labeling (standard or custom) shall be on the side of the reel opposite the sprocket holes. Refer to EIA-556.

Embossed Carrier Tape Configuration: Figure 1



Table 1 — EMBOSSED TAPE DIMENSIONS (Metric will govern)

Constant Dimensions — Millimeters (Inches)									
Tape Size	D ₀	E	P ₀	P ₂	T Max	T ₁ Max			
8 mm and 12 mm	1.5 +0.10 -0.0 (0.059 +0.004, -0.0)	1.75 ±0.10 (0.069 ±0.004)	4.0 ±0.10 (0.157 ±0.004)	2.0 ±0.05 (0.079 ±0.002)	0.600 (0.024)	0.100 (0.004)			
Variable Dimensions — Millimeters (Inches)									
Tape Size	Pitch	B ₁ Max. Note 1	D ₁ Min. Note 2	F	P ₁	R Min. Note 3	T ₂ Max	W	A ₀ B ₀ K ₀ Note 4
8 mm	Single (4 mm)	4.4 (0.173)	1.0 (0.039)	3.5 ±0.05 (0.138 ±0.002)	4.0 ±0.10 (0.157 ±0.004)	25.0 (0.984)	2.5 (0.098)	8.0 ±0.30 (.315 ±0.012)	
12 mm	Double (8 mm)	8.2 (0.323)	1.5 (0.059)	5.5 ±0.05 (0.217 ±0.002)	8.0 ±0.10 (0.315 ±0.004)	30.0 (1.181)	4.6 (0.181)	12.0 ±0.30 (0.472 ±0.012)	

NOTES

- B₁ dimension is a reference dimension for tape feeder clearance only.
- The embossment hole location shall be measured from the sprocket hole controlling the location of the embossment. Dimensions of embossment location and hole location shall be applied independent of each other.
- Tape with components shall pass around radius "R" without damage (see sketch A). The minimum trailer length (Fig. 2) may require additional length to provide R min. for 12 mm embossed tape for reels with hub diameters approaching N min. (Table 2)
- The cavity defined by A₀, B₀, and K₀ shall be configured to surround the part with sufficient clearance such that the chip does not protrude beyond the sealing plane of the cover tape, the chip can be removed from the cavity in a vertical direction without mechanical restriction, rotation of the chip is limited to 20 degrees maximum in all 3 planes, and lateral movement of the chip is restricted to 0.5 mm maximum in the pocket (not applicable to vertical clearance.)

TANTALUM, CERAMIC AND ALUMINUM CHIP CAPACITORS



Packaging Information

Embossed Carrier Tape Configuration (cont.)

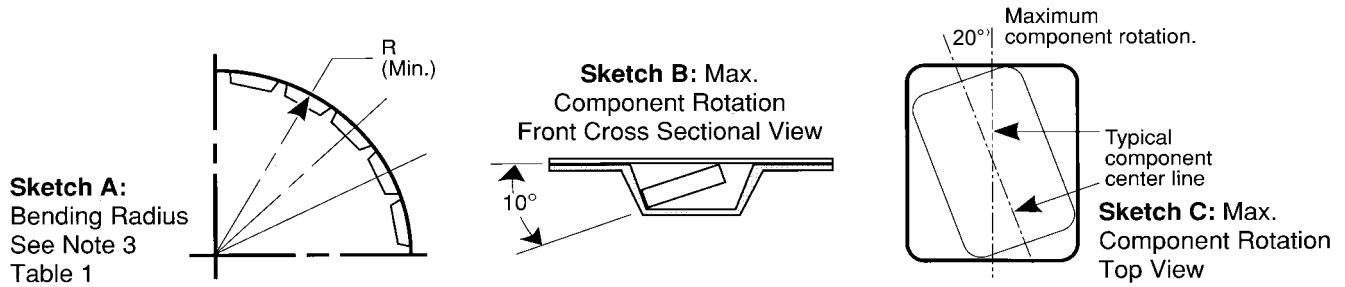

Sketch D: Tape Camber (Top View)

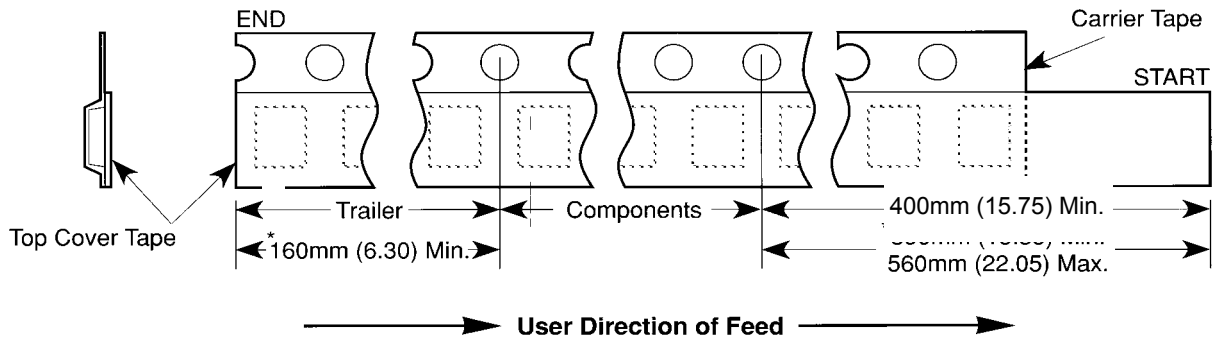
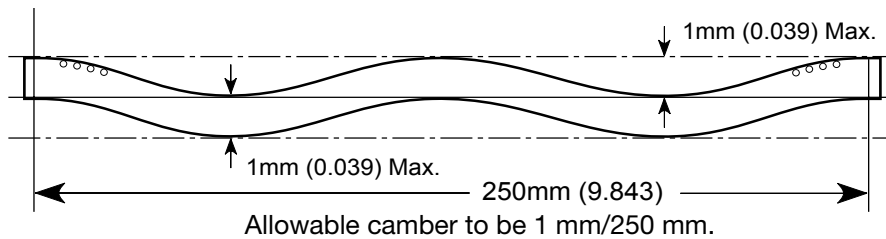

Figure 2: Tape Leader & Trailer Dimensions (Metric Dimensions Will Govern)

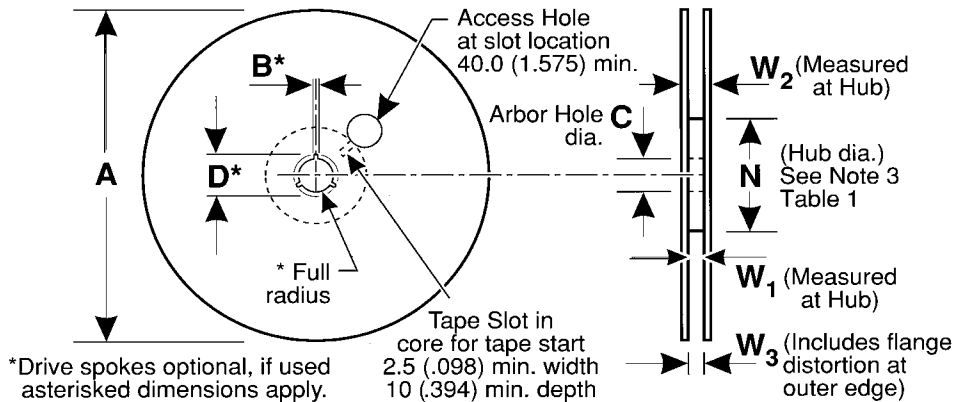

Figure 3: Reel Dimensions (Metric Dimensions will govern)

Table 2 – REEL DIMENSIONS (Metric will govern)

Tape Size	A Max	B* Min	C	D* Min	N Min	W ₁	W ₂ Max	W ₃
8 mm	330.0 (12.992)	1.5 (0.059)	13.0 ± 0.20 (0.512 ± 0.008)	20.2 (0.795)	50.0 (1.969) See Note 3 Table 1	8.4 +1.5, -0.0 (0.331 +0.059, -0.0)	14.4 (0.567)	7.9 Min (0.311) 10.9 Max (0.429)
12 mm	330.0 (12.992)	1.5 (0.059)	13.0 ± 0.20 (0.512 ± 0.008)	20.2 (0.795)	Table 1	12.4 +2.0, -0.0 (0.488 +0.078, -0.0)	18.4 (0.724)	11.9 Min (0.469) 15.4 Max (0.606)

Punched Carrier (Paper Tape) Configuration (Ceramic Chips Only):

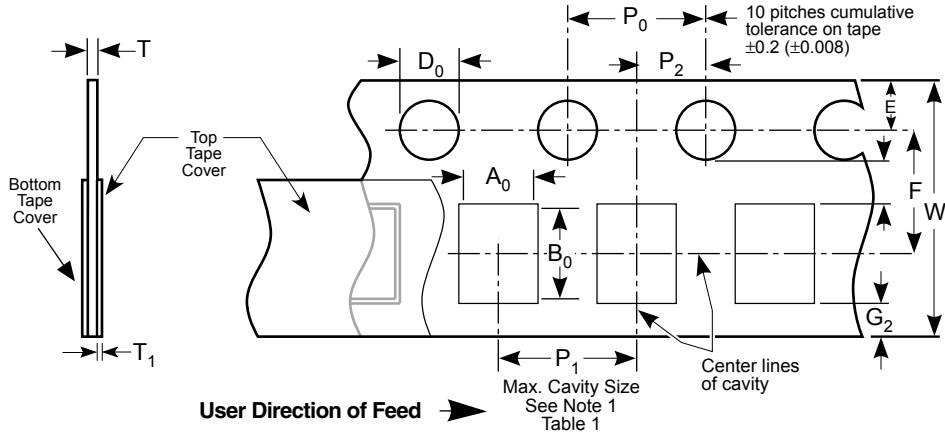

Table 1: 8 & 12mm Punched Tape
(Metric Dimensions Will Govern)

Constant Dimensions - Millimeters (Inches)

Tape Size	D ₀	E	P ₀	P ₂	T ₁	G ₁	G ₂	R Min.
8mm and 12mm	1.5 +0.10, -0.0 (.059 +0.004, -0.0)	1.75 ±0.10 (.069 ±0.004)	4.0 ± 0.10 (.157 ± 0.004)	2.0 ± 0.05 (.079 ± 0.002)	0.10 (.004) Max.	0.75 (.030) Min.	0.75 (.030) Min.	25 (.984) See Note 2 Table 1

Table 1: 8 & 12mm Punched Tape
(Metric Dimensions Will Govern)

Variable Dimensions - Millimeters (Inches)

Tape Size	P ₁	F	W	A ₀ B ₀	T
8mm 1/2 Pitch	2.0 ± 0.10 (.079 ±.004) See Requirements Section 3.3 (d)	3.5 ± 0.05 (.138 ± .002)	8.0 ± 0.3 (.315 ± 0.012)	See Note 1 Table 1	1.1mm (.043) Max. for Paper Base Tape and 1.6mm (.063) Max. for Non- Paper Base Compositions. See Note 3.
8mm	4.0 ± 0.10 (0.157 ± .004)				
12mm	4.0 ± 0.10 (0.157 ± .004)	5.5 ± 0.05 (.217 ± .002)	12.0 ± 0.3 (.472 ± .012)		
12mm Double Pitch	8.0 ± 0.10 (0.315 ± .004)				

Note:

- A₀, B₀ and T determined by the maximum dimensions to the ends of the terminals extending from the body and/or the body dimensions of the component. The clearance between the ends of the terminals or body of the component to the sides and depth of the cavity (A₀, B₀ and T) must be within 0.05mm (.002) minimum and 0.50mm (.020) maximum. The clearance allowed must also prevent rotation of the component within the cavity of not more than 20 degrees (see sketches A and B).
- Tape with components shall pass around radius "R" without damage.
- KEMET nominal thicknesses are: 0402 = 0.6mm and all others 0.95mm minimum.

Sketch A:
Bending Radius
See Note 2
Table 1

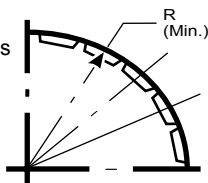

Sketch B:
Max. Component
Rotation - Front
Cross Sectional View

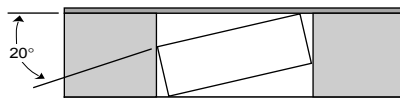

Sketch C:
Component Rotation - Top View

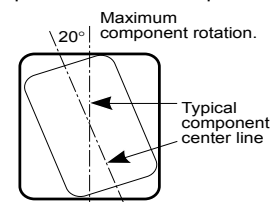

Bulk Cassette Packaging (Ceramic Chips only) (Meets Dimensional Requirements IEC-286-6 and EIAJ 7201)

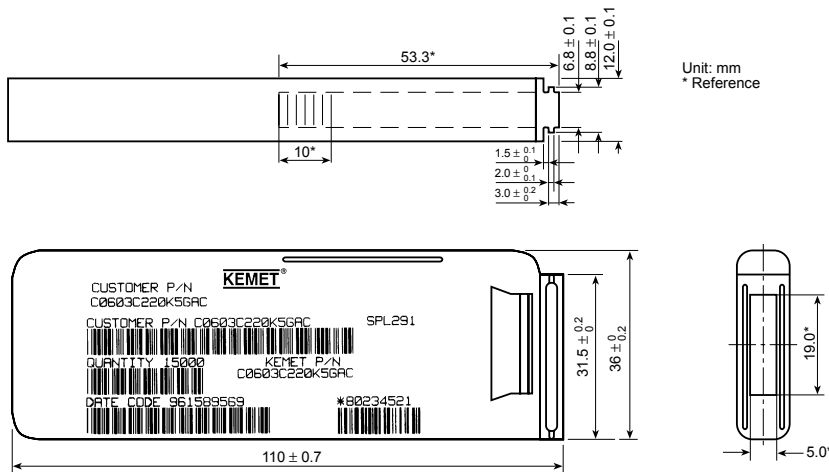

Table 2 – Capacitance Values Available In Bulk Cassette Packaging

Case Size	Dielectric	Voltage	Min. Cap Value	Max. Cap Value
0402	All	All	All	All
0603	All	All	All	All
0805	C0G	200	109	181
		100	109	331
		50	109	102
	X7R	200	221	392
		100	221	103
		50	221	273
25		221	104	
Y5V	25	104	224	
	16	104	224	

Table 1 – Capacitor Dimensions for Bulk Cassette Packaging – Millimeters

Metric Size Code	EIA Size Code	Length L	Width W	Thickness T	Bandwidth B	Minimum Separation S	Number of Pcs/Cassette
1005	0402	1.0 ± 0.05	0.5 ± 0.05	0.5 ± .05	0.2 to 0.4	0.3	50,000
1608	0603	1.6 ± 0.07	0.8 ± 0.07	0.8 ± .07	0.2 to 0.5	0.7	15,000
2012	0805	2.0 ± 0.10	1.25 ± 0.10	0.6 ± .10	0.5 to 0.75	0.75	10,000

Terminations: KEMET nickel barrier layer with a tin overplate.

CAPACITOR MARKING TABLE (Marking Optional - Not Available for 0402 Size or Y5V Dielectric)

Alpha Character	Capacitance (pF) For Various Numerical Identifiers						
	9	0	1	2	3	4	5
A	0.10	1.0	10	100	1000	10,000	100,000
B	0.11	1.1	11	110	1100	11,000	110,000
C	0.12	1.2	12	120	1200	12,000	120,000
D	0.13	1.3	13	130	1300	13,000	130,000
E	0.15	1.5	15	150	1500	15,000	150,000
F	0.16	1.6	16	160	1600	16,000	160,000
G	0.18	1.8	18	180	1800	18,000	180,000
H	0.20	2.0	20	200	2000	20,000	200,000
J	0.22	2.2	22	220	2200	22,000	220,000
K	0.24	2.4	24	240	2400	24,000	240,000
L	0.27	2.7	27	270	2700	27,000	270,000
M	0.30	3.0	30	300	3000	30,000	300,000
N	0.33	3.3	33	330	3300	33,000	330,000
P	0.36	3.6	36	360	3600	36,000	360,000
Q	0.39	3.9	39	390	3900	39,000	390,000
R	0.43	4.3	43	430	4300	43,000	430,000
S	0.47	4.7	47	470	4700	47,000	470,000
T	0.51	5.1	51	510	5100	51,000	510,000
U	0.56	5.6	56	560	5600	56,000	560,000
V	0.62	6.2	62	620	6200	62,000	620,000
W	0.68	6.8	68	680	6800	68,000	680,000
X	0.75	7.5	75	750	7500	75,000	750,000
Y	0.82	8.2	82	820	8200	82,000	820,000
Z	0.91	9.1	91	910	9100	91,000	910,000
a	0.25	2.5	25	250	2500	25,000	250,000
b	0.35	3.5	35	350	3500	35,000	350,000
d	0.40	4.0	40	400	4000	40,000	400,000
e	0.45	4.5	45	450	4500	45,000	450,000
f	0.50	5.0	50	500	5000	50,000	500,000
m	0.60	6.0	60	600	6000	60,000	600,000
n	0.70	7.0	70	700	7000	70,000	700,000
t	0.80	8.0	80	800	8000	80,000	800,000
y	0.90	9.0	90	900	9000	90,000	900,000

Laser marking is available as an extra-cost option for most KEMET ceramic chips. Such marking is two sided, and includes a \bar{K} to identify KEMET, followed by two characters (per EIA-198 - see table below) to identify the capacitance value. Note that marking is not available for size 0402 nor for any Y5V chip. In addition, the 0603 marking option is limited to the \bar{K} only.



Example shown is 1,000 pF capacitor.