

Safety Standard Recognized, C900, Encapsulated, AH Type, X1 400 VAC/Y1 250 VAC (Industrial Grade)

Overview

KEMET's 900 series encapsulated radial leaded ceramic disc capacitors are specifically designed for interference-suppression AC line filtering applications. Having internationally recognized safety certifications, these capacitors are well-suited for applications that require keeping potentially disruptive or damaging line transients and EMI out of susceptible equipment. They are also an ideal solution when needing to suppress line disturbances at the source.

Safety Certified Capacitors are classified as either X and/or Y capacitors. Class X capacitors are primarily used in line-to-line (across-the-line) applications. In this application there is no danger of electric shock to humans should the

capacitor fail, but could result in a risk of fire. The class Y capacitor is primarily used in line-to-ground (line by-pass) applications. In this application, failure of the capacitor could lead to danger of electric shock.

With a working voltage of 400 VAC in line-to-line (Class X) and 250 VAC in line-to-ground (Class Y) applications, these safety capacitors meet the impulse test criteria outlined in IEC Standard 60384. Meeting subclass X1 and Y1 requirements, these devices are certified to withstand impulses up to 4 KV (X1) and 8 KV (Y1) respectively. These encapsulated devices also meet the flame test requirements outlined in UL Standard 94 V-0.

Benefits

- Safety Standard Recognized (IEC 60384-14)
- Reliable operation up to 125°C
- Class X1/Y1
- 10 mm lead spacing
- Lead (Pb)-free and RoHS Compliant
- Halogen free
- Capacitance offerings ranging from 15 – 4,700 pF
- Available capacitance tolerances of $\pm 5\%$, $\pm 10\%$, and $\pm 20\%$
- High reliability
- Preformed (crimped) or straight lead configurations
- Non-polar device, minimizing installation concerns
- 100% pure matte tin-plated lead finish allowing for excellent solderability
- Encapsulation meets flammability standard UL 94 V-0

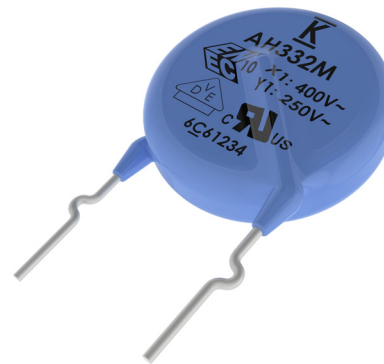

Applications

Typical applications include:

- Line-to-line (Class X) filtering
- Line-to-ground (Class Y) filtering
- Antenna coupling
- Primary and secondary coupling (switching power supplies)
- Line disturbances suppression (motors and motor controls, relays, switching power supplies, and invertors)

Ordering Information

C9	1	1	U	620	J	U	S	D	A	A	7317
Ceramic Series	Body Diameter	Lead Spacing ¹	Spec.	Capacitance Code (pF)	Capacitance Tolerance	Rated Voltage	Dielectric/Temp. Char.	Design	Lead Configuration ²	Failure Rate	Packaging (C-Spec)
C9 = Ceramic 900 Series	0 = 7.0 mm 1 = 8.0 mm 2 = 9.0 mm 3 = 10.0 mm 4 = 11.0 mm 5 = 12.0 mm 7 = 14.0 mm	1 = 10.0 mm	U = Safety	Two significant digits and number of zeroes	J = ±5% K = ±10% M = ±20%	U = X1 400 VAC/ Y1 250 VAC	S = SL Y = Y5P W = Y5U V = Y5V	D = Disc	A = Straight B = Vertical Kink C = Outside Kink	A = N/A	See "Packaging C-Spec Ordering Options Table"

¹ "Vertical Kink" and "Outside Kink" lead configurations cannot be combined with the bulk/20 mm lead length option (WL20). 20 mm lead length is only available on capacitors ordered with straight leads (lead configuration ordering code "A"). For nonstandard lead length inquiries, please contact KEMET.

² Bulk packaging lead length availability is dependent upon "Lead Configuration." See "Dimensions" section of this document to verify availability of a specific lead length option. For nonstandard lead length inquiries, please contact KEMET.

Packaging C-Spec Ordering Options Table

Packaging Type	Lead Length (mm) ^{2,3}	Packaging Ordering Code (C-Spec)
Ammo Pack	See Note 5	7317
Bulk Bag	3.0±1.0	WL30
	3.5±1.0	WL35
	4.0±1.0	WL40
	4.5±1.0	WL45
	5.0±1.0	WL50
	20.0 minimum ⁴	WL20

¹ Preformed (crimped) lead configurations include "Vertical Kink" and "Outside Kink." See "Lead Configurations" and "Ordering Information" sections of this document for further details.

² "Vertical Kink" and "Outside Kink" lead configurations cannot be combined with the bulk/20 mm lead length option (WL20). 20 mm lead length is only available on capacitors with straight leads (lead configuration ordering code "A"). For nonstandard lead length inquiries, please contact KEMET.

³ For nonstandard lead length inquiries, please contact KEMET.

⁴ Lead length of 20.0 mm minimum only available for straight leads.

⁵ Lead length for ammo pack packaging is defined by the H and H₀ dimensions in Table 3.

Lead Configurations

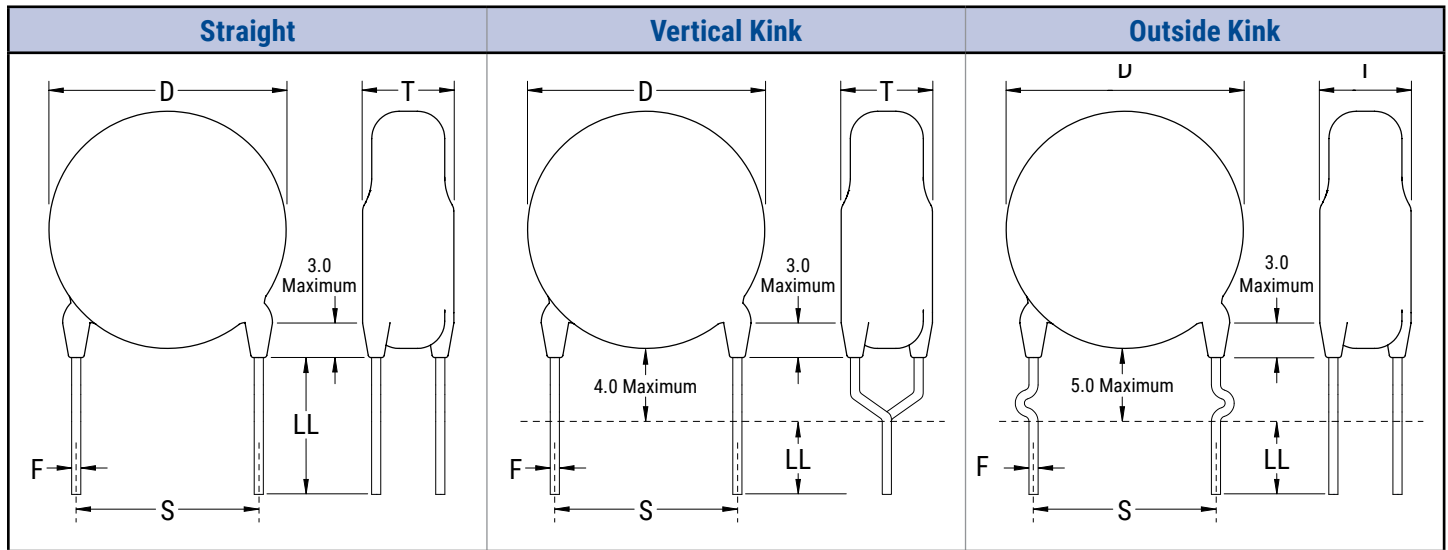

Dimensions – Millimeters

Lead Configuration	Lead Configuration Ordering Code ¹	S	Lead Spacing Tolerance	D	T	e	ØF
		Lead Spacing ²		Body Diameter ²	Body Thickness	Lead Meniscus	Lead Diameter
Straight	A	10.0	±1.0	See Table 1 - "Product Ordering Codes and Ratings"		3.0 maximum	0.55±0.1
Vertical Kink (Preformed)	B	10.0	±1.0				
Outside Kink (Preformed)	C	10.0	±1.0				

¹ Lead Configuration is identified in the 13th character of the ordering code. See "Lead Configuration" and "Ordering Information" sections of this document for further details.

² Body diameter of capacitor will limit available lead spacing and packaging options. See "Product Ordering Codes and Ratings" sections of this document for further details.

Approval Standard and Certification No.

Safety Standard	Standard No.	Subclass	Working Voltage	Certificate No.
VDE (ENEC)	IEC 60384-14	X1	400 VAC	40036417
		Y1	250 VAC	
UL CAN/CSA	UL 60384-14 and E60384-14	X1	400VAC	E356389
		Y1	250VAC	

These devices are VDE/ENEC and UL recognized for antenna coupling and AC line-to-line (Class X) and line-to-ground (Class Y) applications per IEC60384-14 and UL 60384-14.

Environmental Compliance

These devices are Halogen-free and RoHS Compliant. They meet all requirements set forth by both EU and China RoHS directives.



General Specifications/Performance Characteristics

Dielectric/Temperature Characteristic	SL	Y5P	Y5U	Y5V
Operating Temperature Range:	-40°C to +125°C			
Capacitance Change with Reference to +25°C and 0 VDC Applied (TCC):	-1,000 ~ +350 ppm/°C	±10%	+20%/-55%	~ +30%/-80%
Dielectric Withstanding Voltage:	4,000 VAC (60 ±5 seconds at 25°C)			
Quality Factor (Q):	30 pF and above: ≥ 1,000 Below 30 pF: ≥ 400 +(20 x C)*	See "Dissipation Factor"		
Dissipation Factor (tanδ) at +25°C ¹ :	See "Quality Factor"	2.50%	2.50%	5.0%
Insulation Resistance (IR) Limit at +25°C:	10,000 MΩ Minimum (500 VDC applied for 60 ±5 seconds at 25°C)			

*C = Nominal capacitance

¹ Capacitance and Dissipation Factor (DF) measured under the following conditions:

SL: 1 MHz ±100 kHz and 1.0 ±0.2 Vrms

X5P, Y5U, and Y5V: 1 kHz ±50 Hz and 1.0 ±0.2 Vrms

Note: When measuring capacitance, it is important to ensure the set voltage level is held constant. The HP4284 and Agilent E4980 have a feature known as Automatic Level Control (ALC). The ALC feature should be switched to "ON."

Table 1 – Product Ordering Codes and Ratings

Dielectric/ Temp. Char.	KEMET Part Number	Capacitance	Capacitance Tolerance	Dimensions (mm)			Lead Spacing	
				Body Diameter (Maximum)	Body Thickness (Maximum)	Lead Diameter	Bulk Packaging	Ammo Packaging
SL	C901U150JUSD(1)A(2)	15 pF	±5%	7.0	5.0	0.55±0.1	10 mm	
	C901U180JUSD(1)A(2)	18 pF						
	C901U200JUSD(1)A(2)	20 pF						
	C901U220JUSD(1)A(2)	22 pF						
	C901U240JUSD(1)A(2)	24 pF						
	C901U270JUSD(1)A(2)	27 pF						
	C901U300JUSD(1)A(2)	30 pF						
	C901U330JUSD(1)A(2)	33 pF						
	C901U360JUSD(1)A(2)	36 pF						
	C901U390JUSD(1)A(2)	39 pF						
	C911U470JUSD(1)A(2)	47 pF						
	C911U500JUSD(1)A(2)	50 pF						
	C911U510JUSD(1)A(2)	51 pF						
	C911U560JUSD(1)A(2)	56 pF						
	C911U620JUSD(1)A(2)	62 pF						
C921U680JUSD(1)A(2)	68 pF							
C921U750JUSD(1)A(2)	75 pF							
C921U820JUSD(1)A(2)	82 pF							
C931U101JUSD(1)A(2)	100 pF							
C931U101JUSD(1)A(2)	100 pF							
C931U101JUSD(1)A(2)	100 pF							
Y5P	C901U101KUYD(1)A(2)	100 pF	±10%	7.0	5.0	0.55±0.1	10 mm	
	C901U151KUYD(1)A(2)	150 pF						
	C901U221KUYD(1)A(2)	220 pF						
	C901U331KUYD(1)A(2)	330 pF						
	C911U471KUYD(1)A(2)	470 pF						
	C921U561KUYD(1)A(2)	560 pF						
	C921U681KUYD(1)A(2)	680 pF						
C941U102KUYD(1)A(2)	1,000 pF							
C941U102KUYD(1)A(2)	1,000 pF							
C941U102KUYD(1)A(2)	1,000 pF							
Y5U	C911U102MUWD(1)A(2)	1,000 pF	±20%	8.0	5.0	0.55±0.1	10 mm	
	C921U152MUWD(1)A(2)	1,500 pF						
	C931U222MUWD(1)A(2)	2,200 pF						
	C951U332MUWD(1)A(2)	3,300 pF						
	C961U392MUWD(1)A(2)	3,900 pF						
	C971U472MUWD(1)A(2)	4,700 pF						
C971U472MUWD(1)A(2)	4,700 pF							
C971U472MUWD(1)A(2)	4,700 pF							
Y5V	C901U102MUVD(1)A(2)	1,000 pF	±20%	7.0	5.5	0.55±0.1	10 mm	
	C911U152MUVD(1)A(2)	1,500 pF						
	C921U222MUVD(1)A(2)	2,200 pF						
	C941U332MUVD(1)A(2)	3,300 pF						
	C951U472MUVD(1)A(2)	4,700 pF						
C951U472MUVD(1)A(2)	4,700 pF							
C951U472MUVD(1)A(2)	4,700 pF							
	KEMET Part Number	Capacitance	Capacitance Tolerance	Body Diameter (Maximum)	Body Thickness (Maximum)	Lead Diameter	Lead Spacing	

(1) To properly complete ordering code, insert the one-digit character code to reflect the required lead configuration: (See "Lead Configuration" section of this document, page 2, for further details.)

A = Straight

B = Vertical Kink

C = Outside Kink

(2) To properly complete ordering code, enter the four-digit numeric or alphanumeric "Packaging C-Spec Ordering Code." See "Dimensions" section of this document, page 2, for available options.

Table 2 – Performance & Reliability: Test Methods and Conditions

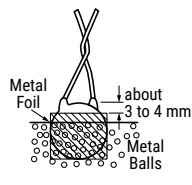
Item		Specification	Test Method																					
Operating Temperature Range		-40°C to +125°C																						
Dielectric Strength	Between lead wires	No failures	The capacitor shall not be damaged when 4,000 VAC (rms) is applied between the lead wires for 60 seconds.																					
	Body Insulation	No failures	<p>The terminals (leads) of the capacitor shall be connected together. A metal foil is tightly wrapped around the body of the capacitor at a distance of about 3 to 4 mm from each terminal. The capacitor is then inserted into a container filled with metal balls approximately 1 mm in diameter. 4,000 VAC (rms) is applied for 60 seconds between the capacitor lead wires and metal balls.</p> 																					
Insulation Resistance (IR)		10,000 MΩ minimum	The insulation resistance shall be measured with 500 ±50 VDC applied after 60 ±5 seconds of charging.																					
Capacitance		Within specified tolerance																						
Dissipation Factor (DF) or Q	<table border="1"> <thead> <tr> <th>Temperature Characteristics</th> <th>Specification</th> </tr> </thead> <tbody> <tr> <td>Y5P, Y5U</td> <td>DF ≤ 2.5%</td> </tr> <tr> <td>Y5V</td> <td>DF ≤ 5.0%</td> </tr> <tr> <td>SL</td> <td>≥ 30 pF: Q ≥ 1,000 < 30 pF: Q ≥ 400 + (20 × C) C = Nominal capacitance</td> </tr> </tbody> </table>		Temperature Characteristics	Specification	Y5P, Y5U	DF ≤ 2.5%	Y5V	DF ≤ 5.0%	SL	≥ 30 pF: Q ≥ 1,000 < 30 pF: Q ≥ 400 + (20 × C) C = Nominal capacitance	<p>Y5P, Y5U, and Y5V: Capacitance is measured at 1 kHz ±20% and 5 V_{rms} or less. (20±2°C) SL: Capacitance is measured at 1 MHz ±20% and 1.0 ±0.2 V_{rms} (25°C)</p>													
	Temperature Characteristics	Specification																						
	Y5P, Y5U	DF ≤ 2.5%																						
	Y5V	DF ≤ 5.0%																						
SL	≥ 30 pF: Q ≥ 1,000 < 30 pF: Q ≥ 400 + (20 × C) C = Nominal capacitance																							
<table border="1"> <thead> <tr> <th>Temperature Characteristics</th> <th>Capacitance Change</th> </tr> </thead> <tbody> <tr> <td>Y5P</td> <td>Within ±10%</td> </tr> <tr> <td>Y5U</td> <td>Within +22%/-56%</td> </tr> <tr> <td>Y5V</td> <td>Within ~+30%/-80%</td> </tr> <tr> <td>SL</td> <td>-1,000 ~+350 ppm°C (+20°C ~+85°C)</td> </tr> </tbody> </table>		Temperature Characteristics	Capacitance Change	Y5P	Within ±10%	Y5U	Within +22%/-56%	Y5V	Within ~+30%/-80%	SL	-1,000 ~+350 ppm°C (+20°C ~+85°C)	<p>A capacitance measurement is made at each step specified:</p> <table border="1"> <thead> <tr> <th>Step</th> <th>Temperature</th> </tr> </thead> <tbody> <tr> <td>1</td> <td>+20±2°C</td> </tr> <tr> <td>2</td> <td>-25±2°C</td> </tr> <tr> <td>3</td> <td>+20±2°C</td> </tr> <tr> <td>4</td> <td>+85±2°C</td> </tr> <tr> <td>5</td> <td>+20±2°C</td> </tr> </tbody> </table>	Step	Temperature	1	+20±2°C	2	-25±2°C	3	+20±2°C	4	+85±2°C	5	+20±2°C
Temperature Characteristics	Capacitance Change																							
Y5P	Within ±10%																							
Y5U	Within +22%/-56%																							
Y5V	Within ~+30%/-80%																							
SL	-1,000 ~+350 ppm°C (+20°C ~+85°C)																							
Step	Temperature																							
1	+20±2°C																							
2	-25±2°C																							
3	+20±2°C																							
4	+85±2°C																							
5	+20±2°C																							
Temperature Characteristics																								
Terminal Strength	Tensile	Lead wire or capacitor body shall not break.	With the termination in its normal position, the specimen is held by its body in such a manner that the axis of the termination is vertical; a tensile force of 10 N is applied to the termination in the direction of its axis and acting in a direction away from the body of the specimen.																					
	Bending	Lead wire or capacitor body shall not break.	With the termination in its normal position, the specimen is held by its body in such a manner that the axis of the termination is vertical; a mass force of 5 N is then suspended from the end of the termination. The body of the specimen is then inclined within a period of 2 to 3 seconds, through an angle of approximately 90° in the vertical plane and then resumed to its initial position over the same period of time; this operation constitutes one bend. One bend immediately followed by a second bend in the opposite direction.																					

¹ "Room Condition" is defined as follows: Temperature: 15 ~ 35°C/Humidity: 45 ~ 75%/Atmospheric Pressure: 86 ~ 106 kPa.

Table 2 – Performance & Reliability: Test Methods and Conditions cont.

Item		Specification		Test Method											
Solderability		Lead wire should have a uniform coating of solder in the axial direction and over 3/4 of its circumference.		The lead wire of the capacitor is dipped into molten solder for 5 ±0.5 seconds. The depth of immersion is up to 1.5 mm (+5/-0 mm) from the root of lead wires. Solder Temperature: Lead free solder (Sn-3Ag – 0.5 Cu) 245°C ±5°C.											
Soldering Effect (Non-Preheat)	Appearance	No visual defect		<p>As shown in the figure below, the lead wires are immersed in molten solder up to 1.5 mm (+5/-0 mm) from the end of the epoxy meniscus (root of lead wire). Duration/Solder Temperature: 3.5±0.5 seconds/350°C ±10°C or 10±1 seconds/260°C ±5°C</p> <p>Pre-treatment: Capacitor is stored at 85°C ±2°C for 1 hour and then placed at room condition¹ for 24 ±2 hours before initial measurements. Post-treatment: Capacitor is stored for 1 to 2 hours at room condition¹.</p>											
	IR	1,000 MΩ													
	Dielectric Strength	Per item 1													
	Capacitance	Y5P, Y5U, and Y5V: Within ±10% SL: Within ±2.5% or ±0.25 pF, whichever is larger													
Soldering Effect (Preheat)	Appearance	No visual defect		<p>Capacitor is stored at 120°C +0/-5°C for 60 +0/-5 seconds. Then, as shown in the figure below, the lead wires are immersed in molten solder up to 1.5 mm (+5/-0mm) from the end of the epoxy meniscus (root of lead wire). Duration/Solder Temperature: 7.5 +0/-1 seconds/260°C ±5°C</p> <p>Pre-treatment: Capacitor is stored at 85°C ±2°C for 1 hour and then placed at room condition¹ for 24 ±2 hours before initial measurements. Post-treatment: Capacitor is stored for 1 to 2 hours at room condition¹.</p>											
	IR	1,000 MΩ													
	Dielectric Strength	Per item 1													
	Capacitance	Y5P, Y5U, and Y5V: Within ±10% SL: Within ±2.5% or ±0.25 pF, whichever is larger													
Biased Humidity	Appearance	No visual defect		Steady State Humidity:	Load Humidity:										
	Capacitance	<table border="1"> <thead> <tr> <th>Temperature Characteristics</th> <th>Capacitance Change</th> </tr> </thead> <tbody> <tr> <td>Y5P</td> <td>Within ±10%</td> </tr> <tr> <td>Y5U</td> <td>Within ±20%</td> </tr> <tr> <td>Y5V</td> <td>Within ±30%</td> </tr> <tr> <td>SL</td> <td>Within ±2.5% or ±0.25 pF, whichever is larger.</td> </tr> </tbody> </table>		Temperature Characteristics	Capacitance Change	Y5P	Within ±10%	Y5U	Within ±20%	Y5V	Within ±30%	SL	Within ±2.5% or ±0.25 pF, whichever is larger.	90 to 95% humidity at 40°C ±2°C for 500 ±12 hours.	90 to 95% humidity at 40°C ±2°C for 500 ±12 hours with full rated voltage applied.
		Temperature Characteristics	Capacitance Change												
		Y5P	Within ±10%												
		Y5U	Within ±20%												
	Y5V	Within ±30%													
	SL	Within ±2.5% or ±0.25 pF, whichever is larger.													
	DF	Y5P and Y5U: 5.0% maximum Y5V: 7.5% maximum													
Q	SL: Less than 30 pF: Q ≥ 100+10×C/3 More than 30 pF: Q ≥ 200 C = Nominal capacitance														
IR	Y5P, Y5V, and Y5U: 3,000 MΩ minimum SL: 1,000 MΩ minimum														
Dielectric Strength	No failures		<p>Post Treatment: Capacitor is stored for 1 to 2 hours at room condition¹.</p>	<p>Post Treatment: Capacitor is stored for 1 to 2 hours at room condition¹.</p>											

¹ "Room Condition" is defined as follows: Temperature: 15 ~ 35°C/Humidity: 45 ~ 75%/Atmospheric Pressure: 86 ~ 106 kPa.

Table 2 – Performance & Reliability: Test Methods and Conditions cont.

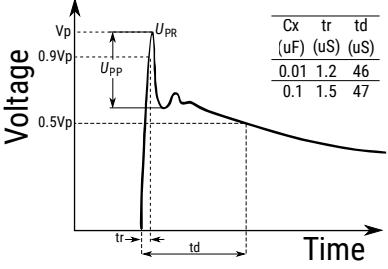
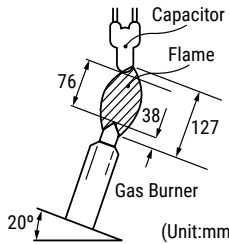
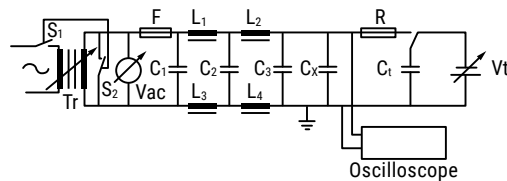
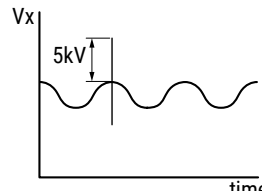
Item		Specification	Test Method																				
High Temperature Life	Appearance	No visual defect	Impulse Voltage: Each individual capacitor is subjected to three 8 kv impulses prior to life testing.  <table border="1" data-bbox="1136 409 1250 493"> <tr> <td>Cx</td> <td>tr</td> <td>td</td> </tr> <tr> <td>(uF)</td> <td>(uS)</td> <td>(uS)</td> </tr> <tr> <td>0.01</td> <td>1.2</td> <td>46</td> </tr> <tr> <td>0.1</td> <td>1.5</td> <td>47</td> </tr> </table>	Cx	tr	td	(uF)	(uS)	(uS)	0.01	1.2	46	0.1	1.5	47								
	Cx	tr		td																			
	(uF)	(uS)		(uS)																			
	0.01	1.2		46																			
0.1	1.5	47																					
Capacitance Change	Y5P, Y5V, and Y5U: Within $\pm 20\%$ SL: Within ± 3 or ± 0.3 pF, whichever is larger.																						
IR	3,000 M Ω minimum SL: 1,000 M Ω minimum																						
Dielectric Strength	No failures																						
Flame Test	The capacitor flame extinguishes as follows:		The capacitor is exposed to a flame for 15 seconds and then removed for 15 seconds. This test is repeated for 5 cycles. 																				
	<table border="1" data-bbox="454 892 803 1081"> <thead> <tr> <th>Cycle</th> <th>Time</th> </tr> </thead> <tbody> <tr> <td>1 ~ 4</td> <td>30 seconds maximum</td> </tr> <tr> <td>5</td> <td>60 seconds maximum</td> </tr> </tbody> </table>			Cycle	Time	1 ~ 4	30 seconds maximum	5	60 seconds maximum														
Cycle	Time																						
1 ~ 4	30 seconds maximum																						
5	60 seconds maximum																						
Active Flammability	The cheesecloth should not ignite.		The capacitors are individually wrapped in at least one, but not more than two, complete layers of cheesecloth. They are then subjected to 20 discharges. The interval between successive discharges is 5 seconds. The VAC is maintained for 2 minutes after the last discharge. 																				
			<table border="1" data-bbox="852 1438 1518 1648"> <tbody> <tr> <td>C_{1,2}</td> <td>1 μF $\pm 10\%$</td> <td>C₃</td> <td>0.033 μF $\pm 5\%$ 10 kV</td> </tr> <tr> <td>L₁₋₄</td> <td>1.5 Mh $\pm 20\%$ 16A Rod core choke</td> <td>C_x</td> <td>Test capacitor</td> </tr> <tr> <td>R</td> <td>100$\pm 2\%$</td> <td>V_{AC}</td> <td>VR $\pm 5\%$</td> </tr> <tr> <td>C_t</td> <td>3 μF $\pm 5\%$ 10 kV</td> <td>V_R</td> <td>Rated Voltage</td> </tr> <tr> <td>F</td> <td>Fuse, Rated 10A</td> <td>V_t</td> <td>Voltage applied to C_t</td> </tr> </tbody> </table>	C _{1,2}	1 μ F $\pm 10\%$	C ₃	0.033 μ F $\pm 5\%$ 10 kV	L ₁₋₄	1.5 Mh $\pm 20\%$ 16A Rod core choke	C _x	Test capacitor	R	100 $\pm 2\%$	V _{AC}	VR $\pm 5\%$	C _t	3 μ F $\pm 5\%$ 10 kV	V _R	Rated Voltage	F	Fuse, Rated 10A	V _t	Voltage applied to C _t
	C _{1,2}	1 μ F $\pm 10\%$	C ₃	0.033 μ F $\pm 5\%$ 10 kV																			
L ₁₋₄	1.5 Mh $\pm 20\%$ 16A Rod core choke	C _x	Test capacitor																				
R	100 $\pm 2\%$	V _{AC}	VR $\pm 5\%$																				
C _t	3 μ F $\pm 5\%$ 10 kV	V _R	Rated Voltage																				
F	Fuse, Rated 10A	V _t	Voltage applied to C _t																				
																							

¹ "Room Condition" is defined as follows: Temperature: 15 ~ 35°C/Humidity: 45 ~ 75%/Atmospheric Pressure: 86 ~ 106 kPa.

Table 2 – Performance & Reliability: Test Methods and Conditions cont.

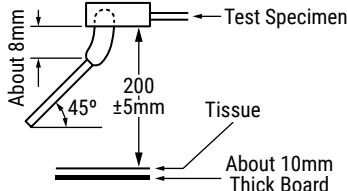
Item		Specification		Test Method																	
Passive Flammability		The burning time should not exceed 30 seconds. The tissue paper should not ignite.		<p>The capacitor under test is held into a flame and in a position which best promotes burning. Each specimen is exposed to the flame one time.</p> 																	
				<p>Time of exposure to flame: 30 seconds Length of flame: 12 ± 1 mm Gas burner length: 35 mm minimum Inside diameter: 0.5 ± 0.1 mm Outside diameter: 0.9 mm maximum Gas butane gas purity: 95% minimum</p>																	
Temperature Cycle	Appearance	No visual defect		<p>The capacitor is subjected to 5 temperature cycles.</p> <p>Temperature Cycle</p> <table border="1" data-bbox="873 940 1497 1222"> <thead> <tr> <th>Step</th> <th>Temperature (°C)</th> <th>Dwell Time (minutes)</th> <th>Transition Time (minutes)</th> </tr> </thead> <tbody> <tr> <td>1</td> <td>-40 +0/-3</td> <td>30</td> <td rowspan="4">3</td> </tr> <tr> <td>2</td> <td>Room temperature</td> <td>3</td> </tr> <tr> <td>3</td> <td>125 +3/-0</td> <td>30</td> </tr> <tr> <td>4</td> <td>Room temperature</td> <td>3</td> </tr> </tbody> </table> <p>Pre-treatment: Capacitor shall be stored at 85 ± 2 for 1 hour then placed at room condition¹ for 24 ± 2 hours. Post-treatment: Capacitor is stored for 1 to 2 hours at room condition¹.</p>	Step	Temperature (°C)	Dwell Time (minutes)	Transition Time (minutes)	1	-40 +0/-3	30	3	2	Room temperature	3	3	125 +3/-0	30	4	Room temperature	3
	Step	Temperature (°C)	Dwell Time (minutes)		Transition Time (minutes)																
	1	-40 +0/-3	30		3																
	2	Room temperature	3																		
	3	125 +3/-0	30																		
	4	Room temperature	3																		
Capacitance	Temperature Characteristics	Capacitance Change																			
	SL	Within ± 5%																			
	Y5P	Within ± 10%																			
Y5U, Y5V	Within ± 20%																				
DF/Q	SL	≥ 30 pF: Q ≥ 350 < 30 pF: Q ≥ 275 +5/2C C = Nominal capacitance																			
	Y5P	DF ≤ 5%																			
	Y5U, Y5V	DF ≤ 7.5%																			
IR	3,000 MΩ minimum SL: 1,000 MΩ minimum																				
Dielectric Strength	No failures																				

¹ "Room Condition" is defined as follows: Temperature: 15 ~ 35°C/Humidity: 45 ~ 75%/Atmospheric Pressure: 86 ~ 106 kPa.

Soldering and Mounting Information

Soldering:

When soldering this product to a PCB/PWB, do not exceed the solder heat resistance specification of the capacitor. Subjecting this product to excessive heating could reflow the solder joint between the lead and ceramic element and/or may result in thermal shocks that can crack the ceramic element.

When soldering these capacitors with a soldering iron, it should be performed under the following conditions:

- Temperature of iron-tip: 400°C maximum
- Soldering iron wattage: 50 W maximum
- Soldering time: 3.5 seconds maximum

Cleaning (ultrasonic cleaning):

To perform ultrasonic cleaning, observe the following conditions:

- Rinse bath capacity: Output of 20 watts per liter or less
- Rinsing time: 5 minute maximum
- Do not vibrate the PCB/PWB directly
- Excessive ultrasonic cleaning may lead to fatigue destruction of the lead wires

Construction

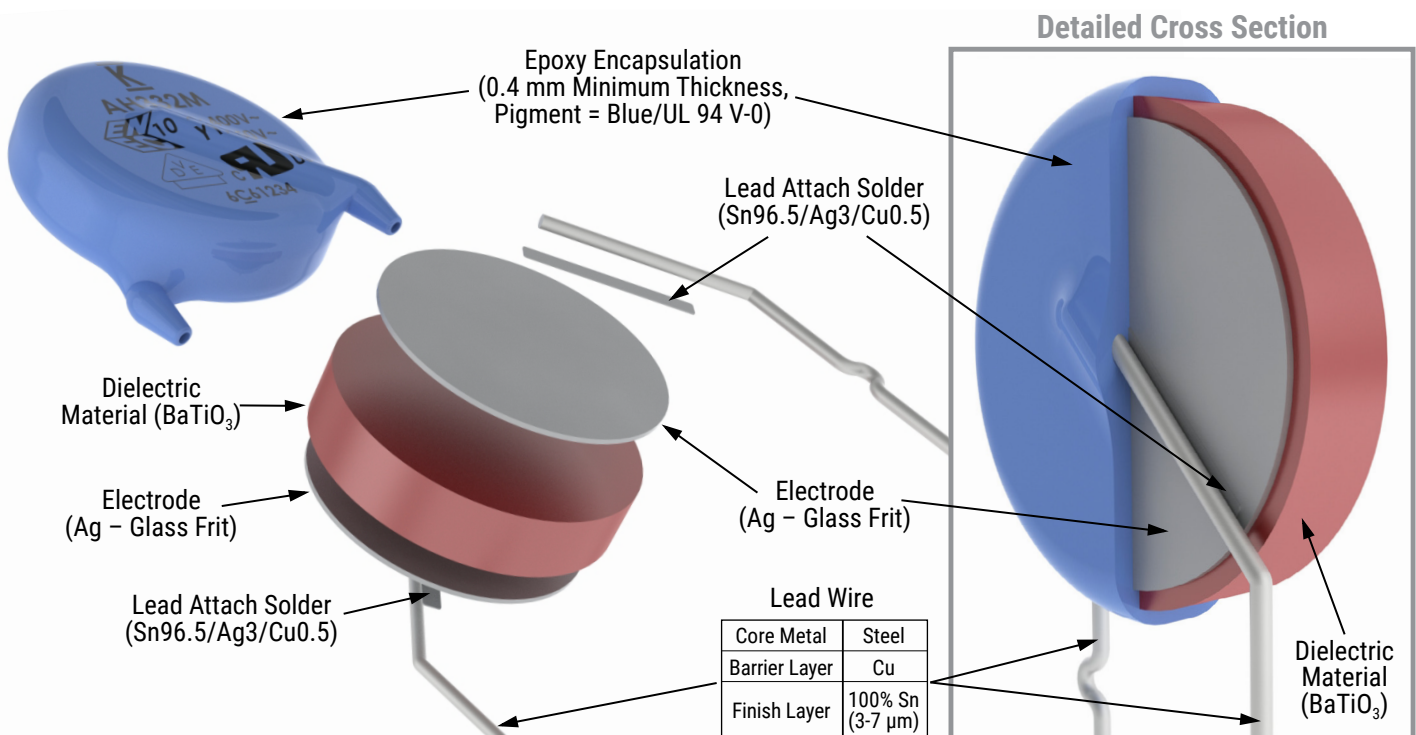

Marking

These capacitors shall be stamped or laser marked with KEMET's trademark, type designation, capacitor class, rated voltage, rated capacitance, and capacitance tolerance codes. In addition, all devices are marked with the recognized approval mark and a date/lot code for traceability. Marking will be supplied either on one side or both sides of the encapsulated capacitor body. All marking shall be legible to allow for clear identification of the component. Marking appears in legible contrast. Illustrated below is an example of the marking format and content. (Two-sided marking is limited to capacitors with body diameters ≤ 8.0 mm)

Single Sided

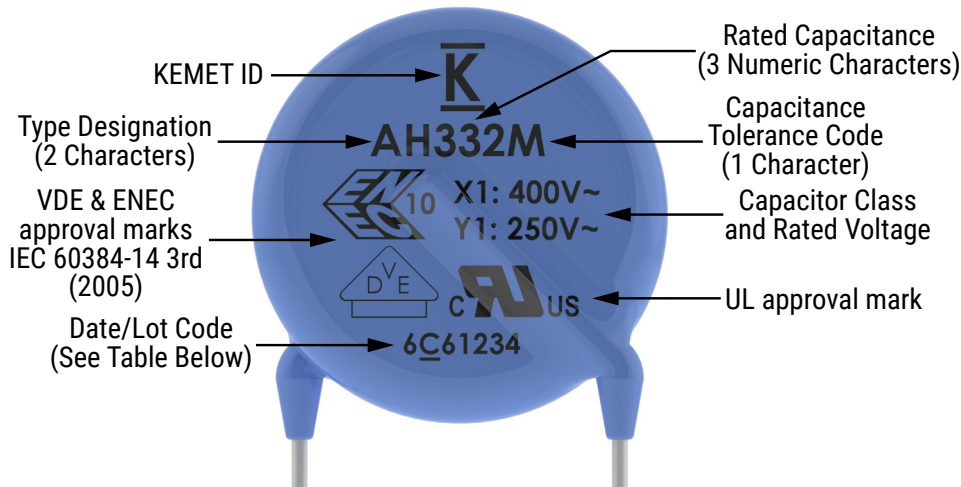

Double Sided

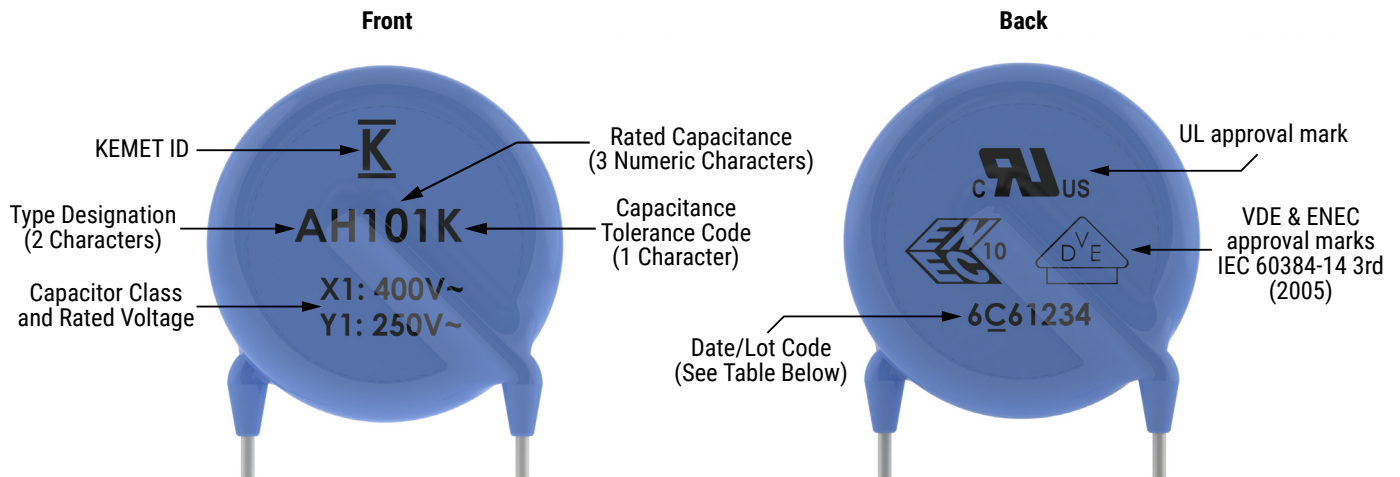

Date/Lot Code Explanation

6	C	6	1234
Last digit of year, e.g., 6 = 2016	Manufacturing Location Code	Manufacturing Month: 1-9 = Jan - Sept A = October N = November D = December	Last 4 digits of lot number

Packaging Quantities

Capacitor Body Diameter (mm)	Body Diameter Code ¹	Bulk Bag (Loose)	Ammo Pack (Carrier Tape)
			Component pitch on carrier tape ²
			25.4 mm
7.0	0	500 pieces/bag	1,000 pieces/box
8.0	1		
9.0	2		
10.0	3		
11.0	4		500 pieces/box
13.0	6		
14.0	7		
15.0	8		

¹ The "Body Diameter Code" is located in the third character position of the ordering code. This code identifies the maximum diameter of the capacitor body in millimeters. For more information regarding the ordering code, see "Ordering Information" section of this document.

² For details regarding component pitch on carrier tape, see "Ammo Pack Taping Format" and "Ammo Pack Taping Specifications" sections of this document.

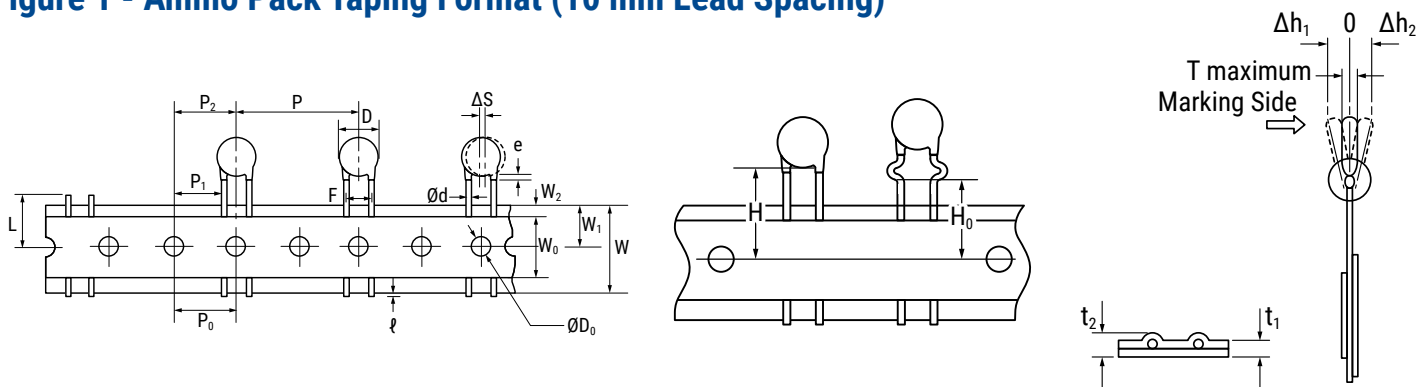
Figure 1 - Ammo Pack Taping Format (10 mm Lead Spacing)

Table 3 – Ammo Pack Taping Specifications

Lead Spacing		10 mm	
Lead Style		Straight	Preformed ¹
Item	Symbol	Dimensions (mm)	
Lead Spacing	F	10.0±1.0	
Component Pitch	P	25.4±2	
Sprocket Hole Pitch	P ₀	12.7±0.3	
Sprocket Hole Center to Component Center	P ₂	12.7±1.5	
Sprocket Hole Center to Lead Center	P ₁	7.7±1.5	
Body Diameter	D	See "Product Ordering Codes and Ratings" section of this document.	
Component Alignment (side/side)	ΔS	0±2.0	
Carrier Tape Width	W	18.0 +1.0/-0.5	
Sprocket Hole Position	W ₁	9.0±0.5	
Height to Seating Plane ² (preformed leads ¹)	H ₀	N/A	18.0 +2.0/-0
Height to Seating Plane ² (straight leads)	H	20.0 +1.5/-1.0	N/A
Lead Protrusion	ℓ	2.0 maximum	
Diameter of Sprocket Hole	D ₀	4.0±0.2	
Lead Diameter	φd	0.55±0.1	
Carrier Tape Thickness	t ₁	0.6±0.3	
Total Thickness (Carrier Tape, Hold-Down Tape and Lead)	t ₂	1.5 maximum	
Component Alignment (front/back)	Δh ₁	2.0 maximum	
	Δh ₂	2.0 maximum	
Cut Out Length	L	11.0 maximum	
Hold-Down Tape Width	W ₀	8.0 minimum	
Hold-Down Tape Position	W ₂	1.5±1.5	
Coating Extension on Leads (meniscus)	e	3.0 maximum for straight lead; not to exceed the bend for preformed ¹ lead configurations.	
Body Thickness	T	See "Product Ordering Codes and Ratings" section of this document.	

¹ Preformed (crimped) lead configurations include vertical kink and outside kink. See "Lead Configurations" and "Ordering Information" sections of this document for further details.

² Also referred to as "lead length" in this document.

Application Notes:

Storage and Operating Conditions:

The insulating coating of these devices does not form an air and moisture-tight seal. Avoid exposure to moisture and do not use or store these devices in a corrosive atmosphere, especially where chloride gas, sulfide gas, acid, alkali, salt, or the like are present. Before cleaning, bonding or molding these devices, it is important to verify that your process does not affect product quality and performance. KEMET recommends testing and evaluating the performance of a cleaned, bonded or molded product prior to implementing and/or qualifying any of these processes. Store the capacitors where the temperature and relative humidity do not exceed 40 degrees Centigrade and 70% respectively. For optimum solderability, capacitor stock should be used promptly, preferably within 6 months of receipt.

Working Voltage:

Application voltage (V_{p-p} or V_{o-p}) must not exceed the voltage rating of the capacitor. Irregular voltages can be generated for a transient period of time when voltage is initially applied and/or removed from a circuit. It is important to choose a capacitor with a voltage rating greater than or equal to these irregular voltages.

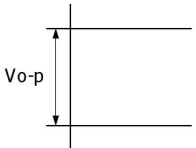
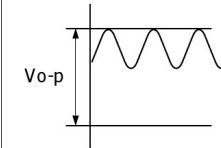
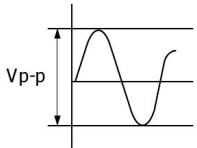
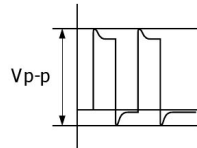
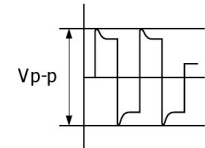
Voltage	DC Voltage	DC+AC Voltage	AC Voltage	Pulse Voltage (1)	Pulse Voltage (2)
Positional Measurement					

Operating Temperature and Self-Generating Heat:

The surface temperature of a capacitor should be kept below the upper limit of its rated operating temperature range. Be sure to take into account the heat generated by the capacitor itself. When the capacitor is used in a high-frequency current, pulse current or similar current, it may self-generate heat due to dielectric loss. Temperature rise due to self-generated heating should not exceed 20°C (while operated at an atmosphere temperature of 25°C).

Handling - Vibration and Impact:

Do not expose these devices or their leads to excessive shock or vibration during use.

FAILURE TO FOLLOW THE ABOVE CAUTIONS MAY RESULT, WORST CASE, IN A SHORT CIRCUIT AND CAUSE FUMING OR PARTIAL DISPERSION WHEN THE PRODUCT IS USED.

KEMET Electronics Corporation Sales Offices

For a complete list of our global sales offices, please visit www.kemet.com/sales.

Disclaimer

All product specifications, statements, information and data (collectively, the "Information") in this datasheet are subject to change. The customer is responsible for checking and verifying the extent to which the Information contained in this publication is applicable to an order at the time the order is placed. All Information given herein is believed to be accurate and reliable, but it is presented without guarantee, warranty, or responsibility of any kind, expressed or implied.

Statements of suitability for certain applications are based on KEMET Electronics Corporation's ("KEMET") knowledge of typical operating conditions for such applications, but are not intended to constitute – and KEMET specifically disclaims – any warranty concerning suitability for a specific customer application or use. The Information is intended for use only by customers who have the requisite experience and capability to determine the correct products for their application. Any technical advice inferred from this Information or otherwise provided by KEMET with reference to the use of KEMET's products is given gratis, and KEMET assumes no obligation or liability for the advice given or results obtained.

Although KEMET designs and manufactures its products to the most stringent quality and safety standards, given the current state of the art, isolated component failures may still occur. Accordingly, customer applications which require a high degree of reliability or safety should employ suitable designs or other safeguards (such as installation of protective circuitry or redundancies) in order to ensure that the failure of an electrical component does not result in a risk of personal injury or property damage.

Although all product-related warnings, cautions and notes must be observed, the customer should not assume that all safety measures are indicated or that other measures may not be required.

KEMET is a registered trademark of KEMET Electronics Corporation.