

KONNEKT KC-LINK Auto COG, Ceramic, 24 uF, 10%, 1200 VDC, COG, 2-Chip Standard Orientation.

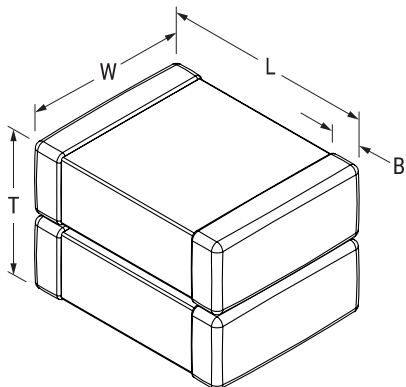

Dimensions

L	5.7mm +/-0.4mm
W	5mm +/-0.4mm
T	5mm +/-0.4mm
B	0.6mm +/-0.35mm

Packaging Specifications

Weight:	600 mg
Packaging:	T&R, 180mm
Packaging Quantity:	300

General Information

Series:	KONNEKT KC-LINK Auto COG
Style:	KONNEKT
Description:	SMD, MLCC, Ultra-Stable, Low Loss, Class I
Features:	Ultra-Stable, Low Loss
RoHS:	Yes
Termination:	Tin
Qualifications:	AEC-Q200
AEC-Q200:	Yes
Notes:	2-Chip Standard Orientation.
Chip Size:	2220
MSL:	1

Specifications

Capacitance:	24 uF
Measurement Condition:	1 kHz 1.0Vrms
Capacitance Tolerance:	10%
Voltage DC:	1200 VDC
Dielectric Withstanding Voltage:	1440 VDC
Temperature Range:	-55/+150°C
Temperature Coefficient:	COG
Capacitance Change with Reference to +25°C and 0 VDC Applied (TCC):	30 ppm/C, 1kHz 1.0Vrms
Dissipation Factor:	0.1% 1 kHz 1.0Vrms
Aging Rate:	0% Loss/Decade Hour
Insulation Resistance:	42 MOhms

Statements of suitability for certain applications are based on our knowledge of typical operating conditions for such applications, but are not intended to constitute - and we specifically disclaim - any warranty concerning suitability for a specific customer application or use. This Information is intended for use only by customers who have the requisite experience and capability to determine the correct products for their application. Any technical advice inferred from this Information or otherwise provided by us with reference to the use of our products is given gratis, and we assume no obligation or liability for the advice given or results obtained.