

C900AC SFTY X1-440 Y2-300, Ceramic, Safety, 20 pF, 5%, 440 VAC (X1), 300 VAC (Y2), C0G, Lead Spacing = 7.5mm

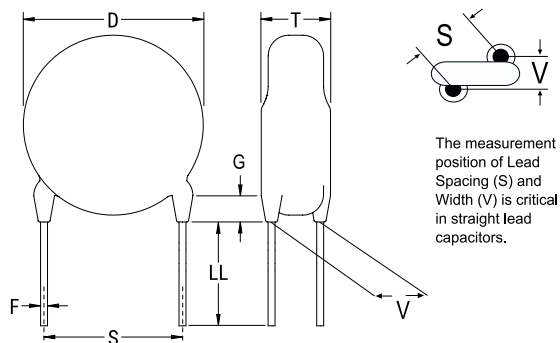

General Information	
Supplier:	KEMET
Series:	C900AC SFTY X1-440 Y2-300
Style:	Radial Disc
RoHS:	Yes
Termination:	Tin
Failure Rate:	N/A
Qualifications:	UL, ENEC, VDE, CSA, CAN
Halogen Free:	Yes

Dimensions	
D	8mm MAX
T	5mm MAX
S	7.5mm +/-1mm
LL	4.5mm +/-1mm
F	0.5mm +/-0.1mm
G	3mm MAX

Specifications	
Capacitance:	20 pF
Capacitance Tolerance:	5%
Voltage AC:	440 VAC (X1), 300 VAC (Y2)
Dielectric Withstanding Voltage:	2,600 V
Temperature Range:	-40/+125C
Temperature Coefficient:	C0G
Insulation Resistance:	10 GOhms
Quality Factor:	800
Safety Class:	X1/Y2

Packaging Specifications	
Packaging:	Bulk, Bag
Packaging Quantity:	500

Statements of suitability for certain applications are based on our knowledge of typical operating conditions for such applications, but are not intended to constitute - and we specifically disclaim - any warranty concerning suitability for a specific customer application or use. This Information is intended for use only by customers who have the requisite experience and capability to determine the correct products for their application. Any technical advice inferred from this Information or otherwise provided by us with reference to the use of our products is given gratis, and we assume no obligation or liability for the advice given or results obtained.