

KEMET Part Number: M123A11BXB103KS
(C1210Z103K5XAH)

SMD Mil PRF123, Ceramic, Military/High Reliability, 0.01 uF, 10%, 50 VDC, BX, SMD Chip, Temperature Stable, N/A, 1210

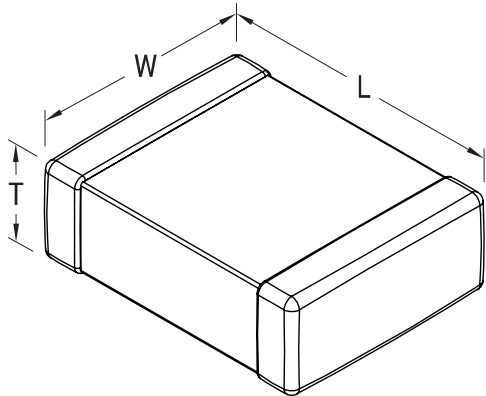

Dimensions	
L	3.048mm +/-0.381mm (0.12 in +/-0.015 in)
W	2.54mm +/-0.381mm (0.1 in +/-0.015 in)
T	1.651mm MAX (0.065 in MAX)

Packaging Specifications	
Packaging:	Waffle
Packaging Quantity:	25000

General Information	
Supplier:	KEMET
Series:	SMD Mil PRF123
Style:	SMD Chip
Description:	SMD Chip, Temperature Stable
RoHS:	No
Prop 65:	WARNING: Cancer and reproductive harm - www.p65warnings.ca.gov .
REACH:	SVHC (Pb – CAS 7439-92-1)
Termination:	Nickel
Failure Rate:	N/A
Chip Size:	1210
Shelf Life:	78 Weeks
MSL:	1

Specifications	
Capacitance:	0.01 uF
Capacitance Tolerance:	10%
Voltage DC:	50 VDC
Temperature Range:	-55/+125C
Temperature Coefficient:	BX