

C&K RTBH Series

1-2 Pole Coded Rotary Switches



Features/Benefits

- **Totally sealed**
- **Detent angles, 15 , 22.5 , 30 and 36**
- **Multi pole**
- **Coding functions**
- **Robust construction**

Typical Applications

- **Telecommunications**
- **Military**
- **Instrumentation**
- **Heavy-duty industrial equipment**

Specifications

CONTACT RATING: S Contact material: Switch: 250mA, 5VA resistive load. Carry: 5 AMPS
 ELECTRICAL LIFE: Up to 25,000 operations.
 OPERATING TORQUE: 5Ncm±30% (with 1 module).
 MECHANICAL STOP RESISTANCE: > 70 Ncm.
 BUSHING MOUNTING TORQUE: 100 Ncm.
 CONTACT RESISTANCE: < 100 mΩ.
 INSULATION RESISTANCE: > 10⁹ Ω
 DIELECTRIC STRENGTH: 500 V rms.

Materials

HOUSING: PBT thermoplastic and PC thermoplastic
 STATIONARY CONTACTS & TERMINALS: Nickel alloy, gold or silver plated, insert molded in PBT thermoplastic.
 ROTOR: Printed circuit, gold or silver plated.
 ACTUATOR: Steel
 BUSHING: Brass
 HARDWARE: Stop pin and spring: Stainless steel
 All models are RoHS compliant and compatible.

NOTE: For the latest information regarding RoHS compliance, please go to: www.ittcannon.com/rohs.

NOTE: Specifications and materials listed above are for switches with standard options. For information on specific and custom switches, consult Customer Service Center.

Build-A-Switch

To order, simply select desired option from each category and place in the appropriate box. Available options are shown and described on pages L-27 thru L-31. For additional options not shown in catalog, consult Customer Service Center.

Rotary

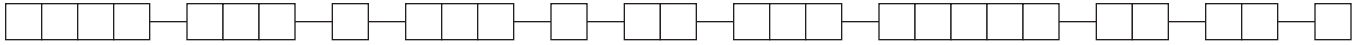

Designation
RTBH

Indexing
15 15°
22.5 22.5°
30 30°
36 36°

Number of Switch Functions**
1 1 Function
2 2 Functions

Switch Function
Number of Poles (first digit)
Maximum Position (second & third digit)
 or code (binary code = B, complement = C, direct + complement = BC)
B Binary code
116 22.5 index, SP, 16 positions
112 30 index, SP, 12 positions
206 DP, 6 positions
C Complement
BC Direct + complement

Stops
B Stop with number of positions
S Without

Mounting Style
AD Standard bushing for panel mount
DE Sealed bushing for panel mount

Shaft Diameter
D6 6 mm (.236)
D63 6.35 mm (.250)

Option of Shaft
(NONE)
M10X5 Shaft with flat

Actuator Option Angle*
(NONE)
K0 0° angle
K60 60° angle
K90 90° angle
K120 120° angle
K180 180° angle
K270 270° angle

Actuator Length
25 25 mm (.984)

Contact Material
S Silver plated
G Gold plated

* Other angles available by request

** Several functions can be combined. For more information consult us.

Dimensions are shown: Inch (mm)
 Specifications and dimensions subject to change

L-26

www.ittcannon.com

C&K RTBH Series 1-2 Pole Coded Rotary Switches

DESIGNATION



RTBH

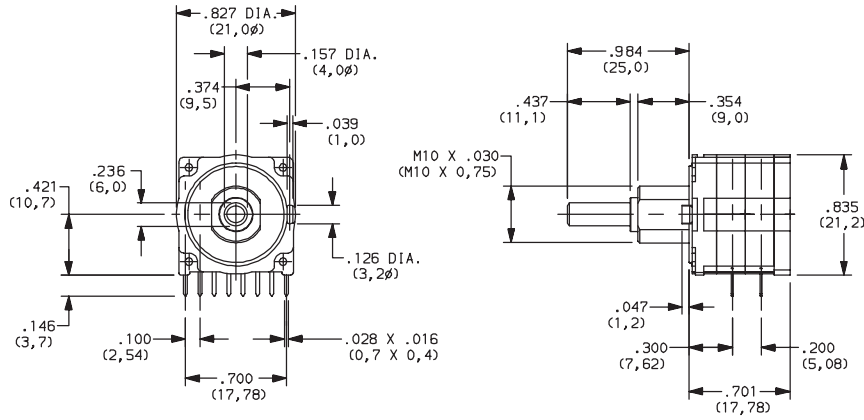

INDEXING

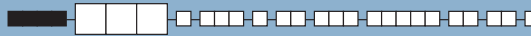

- 15** 15° index
- 22.5** 22.5° index
- 30** 30° index
- 36** 36° index



Rotary

NUMBER OF SWITCH FUNCTIONS



- 1** 1 FUNCTION
- 2** 2 FUNCTIONS

NOTE: Several functions can be combined. For more information consult us.

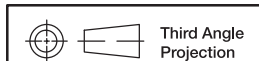

Dimensions are shown: Inch (mm)
Specifications and dimensions subject to change

C&K RTBH Series 1-2 Pole Coded Rotary Switches

NUMBER OF POLES / POSITIONS



- 116** 22.5 INDEX, SP, 16 POSITIONS
- 112** 30 INDEX, SP, 12 POSITIONS
- 206** 30 INDEX, DP, 6 POSITIONS
- B** BINARY CODE, 15 /22.5 /30 /36
- C** COMPLEMENT, 15 /22.5 /30 /36
- BC** DIRECT + COMPLEMENT, 15 /22.5 /30 /36

SINGLE POLE FUNCTION

| | C | 1 | 2 | 3 | 4 | 5 | 6 | 7 | 8 | 9 | 10 | 11 | 12 | 13 | 14 | 15 | 16 | 17 | 18 | 19 | 20 | 21 | 22 | 23 | 24 |
|----|---|---|---|---|---|---|---|---|---|---|----|----|----|----|----|----|----|----|----|----|----|----|----|----|----|
| 1 | ● | ● | | | | | | | | | | | | | | | | | | | | | | | |
| 2 | ● | | ● | | | | | | | | | | | | | | | | | | | | | | |
| 3 | ● | | | ● | | | | | | | | | | | | | | | | | | | | | |
| 4 | ● | | | | ● | | | | | | | | | | | | | | | | | | | | |
| 5 | ● | | | | | ● | | | | | | | | | | | | | | | | | | | |
| 6 | ● | | | | | | ● | | | | | | | | | | | | | | | | | | |
| 7 | ● | | | | | | | ● | | | | | | | | | | | | | | | | | |
| 8 | ● | | | | | | | | ● | | | | | | | | | | | | | | | | |
| 9 | ● | | | | | | | | | ● | | | | | | | | | | | | | | | |
| 10 | ● | | | | | | | | | | ● | | | | | | | | | | | | | | |
| 11 | ● | | | | | | | | | | | ● | | | | | | | | | | | | | |
| 12 | ● | | | | | | | | | | | | ● | | | | | | | | | | | | |
| 13 | ● | | | | | | | | | | | | | ● | | | | | | | | | | | |
| 14 | ● | | | | | | | | | | | | | | ● | | | | | | | | | | |
| 15 | ● | | | | | | | | | | | | | | | ● | | | | | | | | | |
| 16 | ● | | | | | | | | | | | | | | | | ● | | | | | | | | |
| 17 | ● | | | | | | | | | | | | | | | | | ● | | | | | | | |
| 18 | ● | | | | | | | | | | | | | | | | | | ● | | | | | | |
| 19 | ● | | | | | | | | | | | | | | | | | | | ● | | | | | |
| 20 | ● | | | | | | | | | | | | | | | | | | | | ● | | | | |
| 21 | ● | | | | | | | | | | | | | | | | | | | | | ● | | | |
| 22 | ● | | | | | | | | | | | | | | | | | | | | | | ● | | |
| 23 | ● | | | | | | | | | | | | | | | | | | | | | | | ● | |
| 24 | ● | | | | | | | | | | | | | | | | | | | | | | | | ● |

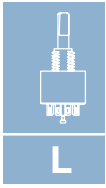

Rotary

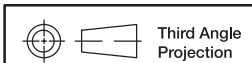
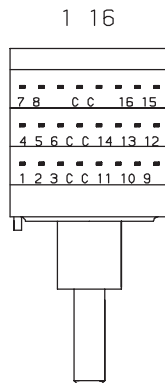
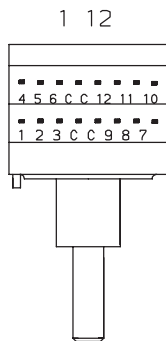

Dimensions are shown: Inch (mm)
Specifications and dimensions subject to change

C&K RTBH Series 1-2 Pole Coded Rotary Switches

NUMBER OF POLES / POSITIONS



DOUBLE POLE FUNCTION

| | C ₁ | 1 ₁ | 2 ₁ | 3 ₁ | 4 ₁ | 5 ₁ | 6 ₁ | C ₂ | 1 ₂ | 2 ₂ | 3 ₂ | 4 ₂ | 5 ₂ | 6 ₂ |
|---|----------------|----------------|----------------|----------------|----------------|----------------|----------------|----------------|----------------|----------------|----------------|----------------|----------------|----------------|
| 1 | ● | ● | | | | | | ● | ● | | | | | |
| 2 | ● | | ● | | | | | ● | | ● | | | | |
| 3 | ● | | | ● | | | | ● | | | ● | | | |
| 4 | ● | | | | ● | | | ● | | | | ● | | |
| 5 | ● | | | | | ● | | ● | | | | | ● | |
| 6 | ● | | | | | | ● | ● | | | | | | ● |

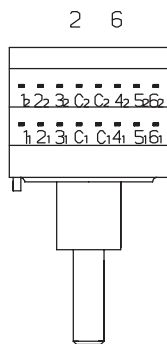

BINARY DIRECT CODE

| | C | 1 | 2 | 4 | 8 | 16 |
|----|---|---|---|---|---|----|
| 0 | ● | | | | | |
| 1 | ● | ● | | | | |
| 2 | ● | | ● | | | |
| 3 | ● | ● | ● | | | |
| 4 | ● | | | ● | | |
| 5 | ● | ● | | | ● | |
| 6 | ● | | ● | | | ● |
| 7 | ● | ● | ● | | | ● |
| 8 | ● | | | ● | | |
| 9 | ● | ● | | | ● | |
| 10 | ● | | ● | | | ● |
| 11 | ● | ● | ● | | | ● |
| 12 | ● | | | ● | | |
| 13 | ● | ● | | | ● | |
| 14 | ● | | ● | | | ● |
| 15 | ● | ● | ● | | | ● |
| 16 | ● | | | | | ● |
| 17 | ● | ● | | | | ● |
| 18 | ● | | ● | | | ● |
| 19 | ● | ● | | | ● | |
| 20 | ● | | ● | | | ● |
| 21 | ● | ● | ● | | | ● |
| 22 | ● | | | ● | | ● |
| 23 | ● | ● | ● | | | ● |

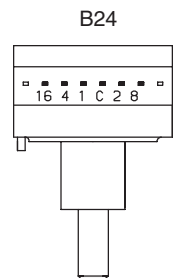
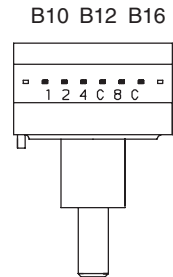

COMPLEMENT BINARY CODE

| | C | 1 | 2 | 4 | 8 | 16 |
|----|---|---|---|---|---|----|
| 0 | ● | ● | ● | ● | ● | ● |
| 1 | ● | ● | ● | ● | ● | ● |
| 2 | ● | ● | ● | ● | ● | ● |
| 3 | ● | ● | ● | ● | ● | ● |
| 4 | ● | ● | ● | ● | ● | ● |
| 5 | ● | ● | ● | ● | ● | ● |
| 6 | ● | ● | ● | ● | ● | ● |
| 7 | ● | ● | ● | ● | ● | ● |
| 8 | ● | ● | ● | ● | ● | ● |
| 9 | ● | ● | ● | ● | ● | ● |
| 10 | ● | ● | ● | ● | ● | ● |
| 11 | ● | ● | ● | ● | ● | ● |
| 12 | ● | ● | ● | ● | ● | ● |
| 13 | ● | ● | ● | ● | ● | ● |
| 14 | ● | ● | ● | ● | ● | ● |
| 15 | ● | ● | ● | ● | ● | ● |
| 16 | ● | ● | ● | ● | ● | ● |
| 17 | ● | ● | ● | ● | ● | ● |
| 18 | ● | ● | ● | ● | ● | ● |
| 19 | ● | ● | ● | ● | ● | ● |
| 20 | ● | ● | ● | ● | ● | ● |
| 21 | ● | ● | ● | ● | ● | ● |
| 22 | ● | ● | ● | ● | ● | ● |
| 23 | ● | ● | ● | ● | ● | ● |

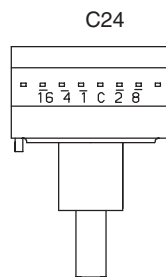
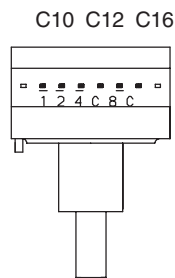

DIRECT AND COMPLEMENT BINARY CODE

| | C | 1 | 2 | 4 | 8 | 16 | C | 1 | 2 | 4 | 8 | 16 |
|----|---|---|---|---|---|----|---|---|---|---|---|----|
| 0 | ● | | | | | | ● | ● | ● | ● | ● | ● |
| 1 | ● | ● | | | | | ● | ● | ● | ● | ● | ● |
| 2 | ● | | ● | | | | ● | ● | ● | ● | ● | ● |
| 3 | ● | ● | ● | | | | ● | ● | ● | ● | ● | ● |
| 4 | ● | | | ● | | | ● | ● | ● | ● | ● | ● |
| 5 | ● | ● | | | ● | | ● | ● | ● | ● | ● | ● |
| 6 | ● | | ● | | | ● | ● | ● | ● | ● | ● | ● |
| 7 | ● | ● | ● | | | ● | ● | ● | ● | ● | ● | ● |
| 8 | ● | | | ● | | | ● | ● | ● | ● | ● | ● |
| 9 | ● | ● | | | ● | | ● | ● | ● | ● | ● | ● |
| 10 | ● | | ● | | | ● | ● | ● | ● | ● | ● | ● |
| 11 | ● | ● | ● | | | ● | ● | ● | ● | ● | ● | ● |
| 12 | ● | | | ● | | | ● | ● | ● | ● | ● | ● |
| 13 | ● | ● | | | ● | | ● | ● | ● | ● | ● | ● |
| 14 | ● | | ● | | | ● | ● | ● | ● | ● | ● | ● |
| 15 | ● | ● | ● | | | ● | ● | ● | ● | ● | ● | ● |
| 16 | ● | | | | | ● | ● | ● | ● | ● | ● | ● |
| 17 | ● | ● | | | | ● | ● | ● | ● | ● | ● | ● |
| 18 | ● | | ● | | | ● | ● | ● | ● | ● | ● | ● |
| 19 | ● | ● | | | ● | | ● | ● | ● | ● | ● | ● |
| 20 | ● | | ● | | | ● | ● | ● | ● | ● | ● | ● |
| 21 | ● | ● | ● | | | ● | ● | ● | ● | ● | ● | ● |
| 22 | ● | | | ● | | ● | ● | ● | ● | ● | ● | ● |
| 23 | ● | ● | ● | | | ● | ● | ● | ● | ● | ● | ● |

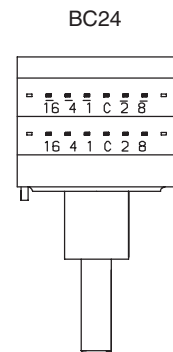
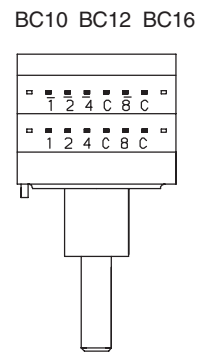

Dimensions are shown: Inch (mm)
Specifications and dimensions subject to change

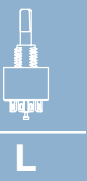

Rotary

C&K RTBH Series 1-2 Pole Coded Rotary Switches

STOPS

B STOP WITH NUMBER OF POSITIONS

S WITHOUT

MOUNTING STYLE

AD STANDARD BUSHING FOR PANEL MOUNT

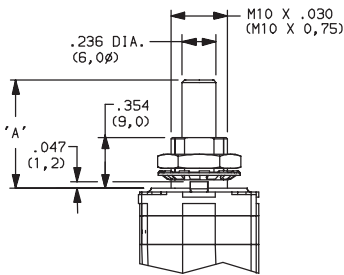

DE SEALED BUSHING FOR PANEL MOUNT

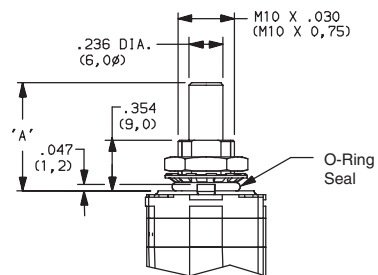

SHAFT DIAMETER

D6 6 mm (.236)

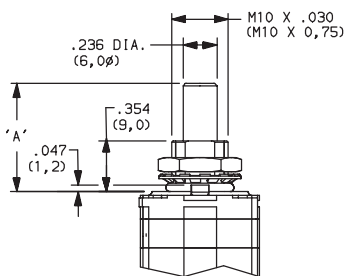

D63 6.35 mm (.250)

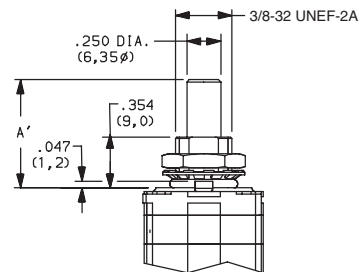

OPTION OF SHAFT

(NONE)

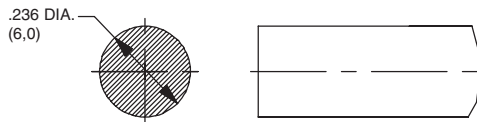

M10X5 FLAT

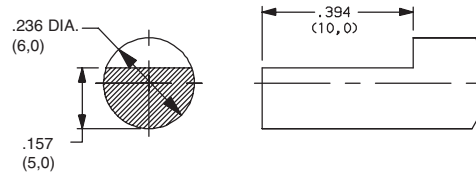

Rotary



Dimensions are shown: Inch (mm)
Specifications and dimensions subject to change

C&K RTBH Series 1-2 Pole Coded Rotary Switches

ACTUATOR OPTION ANGLE



(NONE)

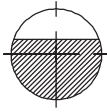

K0 0 ANGLE

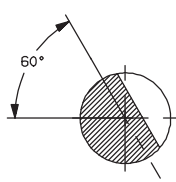

K60 60°

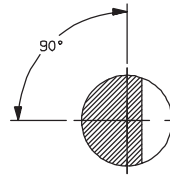

K90 90°

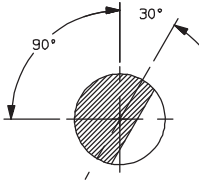

K120 120°

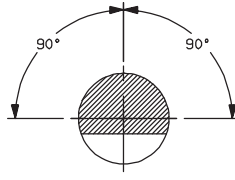

K180 210°

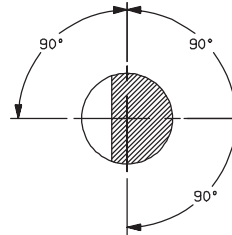

K270 300°

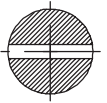

K0 (STD.) 0 ANGLE

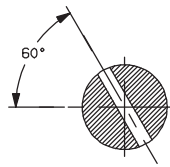

K60 60°

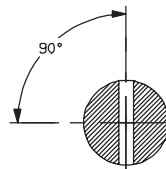

K90 90°

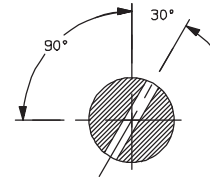

K120 120°

ACTUATOR LENGTH



25 0,25 mm (.984) STANDARD SHAFT

Other lengths available by request.

CONTACT MATERIAL



| OPTION CODE | RoHS COMPLIANT* | RoHS COMPATIBLE* | CONTACT AND TERMINAL MATERIAL | RATING | |
|-------------|-----------------|------------------|-------------------------------|--------------------------------|--|
| | | | | LOW LEVEL/DRY CIRCUIT | SWITCH: 250 mA, POWER: 5 VA; CARRY: 5 AMPS |
| S | YES | YES | SILVER | LOW LEVEL/DRY CIRCUIT | SWITCH: 250 mA, POWER: 5 VA; CARRY: 5 AMPS |
| G | YES | YES | GOLD | LOW LEVEL/DRY CIRCUIT OR POWER | SWITCH: 20 mA, POWER: 0.2 VA; CARRY: 1 AMP |

* Note: See Technical Data section of this catalog for RoHS compliant and compatible definition and specifications.



Third Angle Projection

Dimensions are shown: Inch (mm)
Specifications and dimensions subject to change

Rotary