

# MOSFET

Metal Oxide Semiconductor Field Effect Transistor

## CoolMOS™ CE

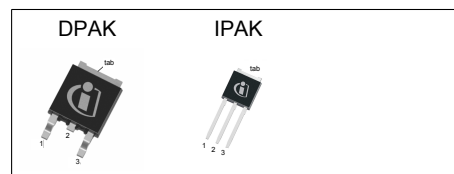
800V CoolMOS™ CE Power Transistor  
IPx80R1K4CE

## Data Sheet

Rev. 2.3  
Final

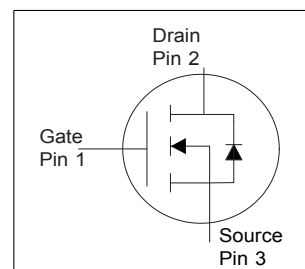
## 1 Description

CoolMOS™ CE is a revolutionary technology for high voltage power MOSFETs. The high voltage capability combines safety with performance and ruggedness to allow stable designs at highest efficiency level. CoolMOS™ 800V CE comes with a selected package choice offering the benefit of reduced system costs and higher power density designs.



## Features

- High voltage technology
- Extreme dv/dt rated
- High peak current capability
- Low gate charge
- Low effective capacitances
- Qualified according to JEDEC Standard
- Pb-free lead plating; RoHS compliant; halogen free mold compound



## Benefits

- Increased power density solutions due to smaller package
- System cost / size savings due to reduced cooling requirements
- Higher system reliability due to low operating temperatures



## Applications

- LED Lighting for retrofit applications in QR Flyback topology

**Table 1 Key Performance Parameters**

Parameter	Value	Unit
$V_{DS} @ T_j=25^{\circ}C$	800	V
$R_{DS(on),max}$	1.4	$\Omega$
$Q_{g,typ}$	23	nC
$I_{D,pulse}$	12	A
$V_{GS(th),typ}$	3	V
$C_{O(tr),typ}$	51	pF

Type / Ordering Code	Package	Marking	Related Links
IPD80R1K4CE	PG-TO 252	8R1K4CE	see Appendix A
IPU80R1K4CE	PG-TO 251		

**Table of Contents**

Description .....	2
Maximum ratings .....	4
Thermal characteristics .....	4
Electrical characteristics .....	5
Electrical characteristics diagrams .....	7
Test Circuits .....	11
Package Outlines .....	12
Appendix A .....	14
Revision History .....	15
Disclaimer .....	15

## 2 Maximum ratings

at  $T_j = 25^\circ\text{C}$ , unless otherwise specified

**Table 2 Maximum ratings**

Parameter	Symbol	Values			Unit	Note / Test Condition
		Min.	Typ.	Max.		
Continuous drain current <sup>1)</sup>	$I_D$	-	-	3.9 2.3	A	$T_C = 25^\circ\text{C}$ $T_C = 100^\circ\text{C}$
Pulsed drain current <sup>2)</sup>	$I_{D,pulse}$	-	-	12	A	$T_C = 25^\circ\text{C}$
Avalanche energy, single pulse	$E_{AS}$	-	-	170	mJ	$I_D = 1.2\text{A}$ ; $V_{DD} = 50\text{V}$
Avalanche energy, repetitive	$E_{AR}$	-	-	0.14	mJ	$I_D = 1.2\text{A}$ ; $V_{DD} = 50\text{V}$
Avalanche current, repetitive	$I_{AR}$	-	-	1.2	A	-
MOSFET dv/dt ruggedness	dv/dt	-	-	50	V/ns	$V_{DS} = 0 \dots 640\text{V}$
Gate source voltage	$V_{GS}$	-20 -30	-	20 30	V	static; AC ( $f > 1\text{ Hz}$ )
Power dissipation (non FullPAK) TO-252, TO-251	$P_{tot}$	-	-	63	W	$T_C = 25^\circ\text{C}$
Operating and storage temperature	$T_j, T_{stg}$	-55	-	150	$^\circ\text{C}$	-
Continuous diode forward current	$I_S$	-	-	3.9	A	$T_C = 25^\circ\text{C}$
Diode pulse current <sup>2)</sup>	$I_{S,pulse}$	-	-	12	A	$T_C = 25^\circ\text{C}$
Reverse diode dv/dt <sup>3)</sup>	dv/dt	-	-	4	V/ns	$V_{DS} = 0 \dots 400\text{V}$ , $I_{SD} \leq I_S$ , $T_j = 25^\circ\text{C}$
Maximum diode commutation speed	$di/dt$	-	-	400	A/ $\mu\text{s}$	$V_{DS} = 0 \dots 400\text{V}$ , $I_{SD} \leq I_S$ , $T_j = 25^\circ\text{C}$

## 3 Thermal characteristics

**Table 3 Thermal characteristics DPAK, IPAK**

Parameter	Symbol	Values			Unit	Note / Test Condition
		Min.	Typ.	Max.		
Thermal resistance, junction - case	$R_{thJC}$	-	-	2	$^\circ\text{C/W}$	-
Thermal resistance, junction - ambient <sup>4)</sup>	$R_{thJA}$	-	- 35	62 -	$^\circ\text{C/W}$	SMD version, device on PCB, minimal footprint SMD version, device on PCB, $6\text{cm}^2$ cooling area <sup>4)</sup>
Soldering temperature, wave- & reflowsoldering allowed	$T_{sold}$	-	-	260	$^\circ\text{C}$	reflow MSL 1

<sup>1)</sup> Limited by  $T_{j,max}$ .

<sup>2)</sup> Pulse width  $t_p$  limited by  $T_{j,max}$ .

<sup>3)</sup> Identical low side and high side switch with identical  $R_G$ .

<sup>4)</sup> Device on  $40\text{mm} \times 40\text{mm} \times 1.5\text{mm}$  one layer epoxy PCB FR4 with  $6\text{cm}^2$  copper area (thickness  $70\mu\text{m}$ ) for drain connection. PCB is vertical without air stream cooling.

## 4 Electrical characteristics

**Table 4 Static characteristics**

Parameter	Symbol	Values			Unit	Note / Test Condition
		Min.	Typ.	Max.		
Drain-source breakdown voltage	$V_{(BR)DSS}$	800	-	-	V	$V_{GS}=0V, I_D=0.25mA$
Gate threshold voltage	$V_{(GS)th}$	2.1	3	3.9	V	$V_{DS}=V_{GS}, I_D=0.24mA$
Zero gate voltage drain current	$I_{DSS}$	-	-	10	$\mu A$	$V_{DS}=800V, V_{GS}=0V, T_j=25^\circ C$ $V_{DS}=800V, V_{GS}=0V, T_j=150^\circ C$
Gate-source leakage current	$I_{GSS}$	-	-	100	nA	$V_{GS}=20V, V_{DS}=0V$
Drain-source on-state resistance	$R_{DS(on)}$	-	1.2	1.4	$\Omega$	$V_{GS}=10V, I_D=2.3A, T_j=25^\circ C$ $V_{GS}=10V, I_D=2.3A, T_j=150^\circ C$
Gate resistance	$R_G$	-	1.2	-	$\Omega$	$f=1\text{ MHz}, \text{open drain}$

**Table 5 Dynamic characteristics**

Parameter	Symbol	Values			Unit	Note / Test Condition
		Min.	Typ.	Max.		
Input capacitance	$C_{iss}$	-	570	-	pF	$V_{GS}=0V, V_{DS}=100V, f=1MHz$
Output capacitance	$C_{oss}$	-	25	-	pF	$V_{GS}=0V, V_{DS}=100V, f=1MHz$
Effective output capacitance, energy related <sup>1)</sup>	$C_{o(er)}$	-	19	-	pF	$V_{GS}=0V, V_{DS}=0\dots 480V$
Effective output capacitance, time related <sup>2)</sup>	$C_{o(tr)}$	-	51	-	pF	$I_D=\text{constant}, V_{GS}=0V, V_{DS}=0\dots 480V$
Turn-on delay time	$t_{d(on)}$	-	25	-	ns	$V_{DD}=400V, V_{GS}=0/10V, I_D=3.9A, R_G=22\Omega$
Rise time	$t_r$	-	15	-	ns	$V_{DD}=400V, V_{GS}=0/10V, I_D=3.9A, R_G=22\Omega$
Turn-off delay time	$t_{d(off)}$	-	72	-	ns	$V_{DD}=400V, V_{GS}=0/10V, I_D=3.9A, R_G=22\Omega$
Fall time	$t_f$	-	12	-	ns	$V_{DD}=400V, V_{GS}=10V, I_D=3.9A, R_G=22\Omega$

**Table 6 Gate charge characteristics**

Parameter	Symbol	Values			Unit	Note / Test Condition
		Min.	Typ.	Max.		
Gate to source charge	$Q_{gs}$	-	3	-	nC	$V_{DD}=640V, I_D=3.9A, V_{GS}=0\text{ to }10V$
Gate to drain charge	$Q_{gd}$	-	12	-	nC	$V_{DD}=640V, I_D=3.9A, V_{GS}=0\text{ to }10V$
Gate charge total	$Q_g$	-	23	-	nC	$V_{DD}=640V, I_D=3.9A, V_{GS}=0\text{ to }10V$
Gate plateau voltage	$V_{plateau}$	-	5.5	-	V	$V_{DD}=640V, I_D=3.9A, V_{GS}=0\text{ to }10V$

<sup>1)</sup>  $C_{o(er)}$  is a fixed capacitance that gives the same stored energy as  $C_{oss}$  while  $V_{DS}$  is rising from 0 to 80%  $V_{(BR)DSS}$ 
<sup>2)</sup>  $C_{o(tr)}$  is a fixed capacitance that gives the same charging time as  $C_{oss}$  while  $V_{DS}$  is rising from 0 to 80%  $V_{(BR)DSS}$

**Table 7 Reverse diode characteristics**

Parameter	Symbol	Values			Unit	Note / Test Condition
		Min.	Typ.	Max.		
Diode forward voltage	$V_{SD}$	-	1	1.2	V	$V_{GS}=0V, I_F=3.9A, T_j=25^\circ C$
Reverse recovery time	$t_{rr}$	-	520	-	ns	$V_R=400V, I_F=3.9A, di_F/dt=100A/\mu s$
Reverse recovery charge	$Q_{rr}$	-	4	-	$\mu C$	$V_R=400V, I_F=3.9A, di_F/dt=100A/\mu s$
Peak reverse recovery current	$I_{rrm}$	-	12	-	A	$V_R=400V, I_F=3.9A, di_F/dt=100A/\mu s$

## 5 Electrical characteristics diagrams

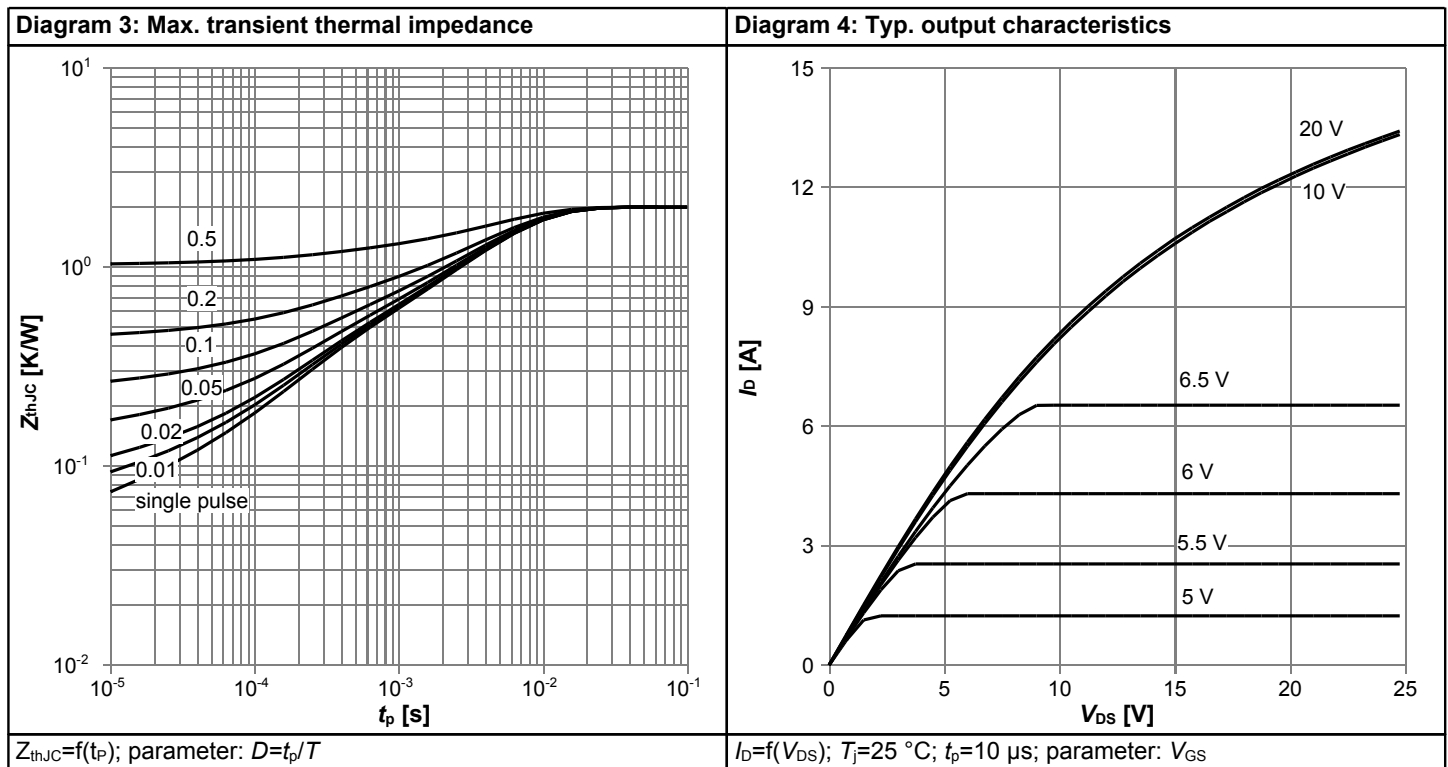
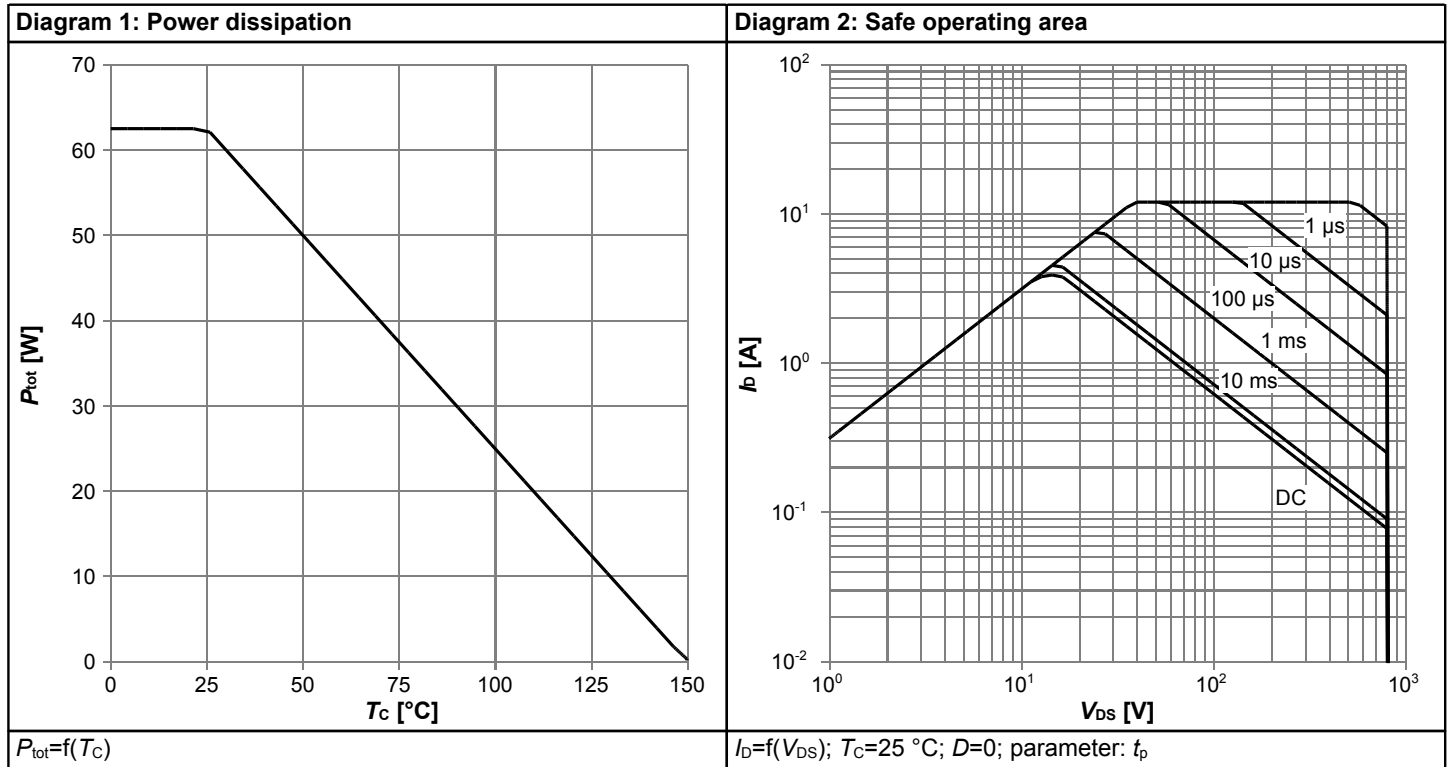
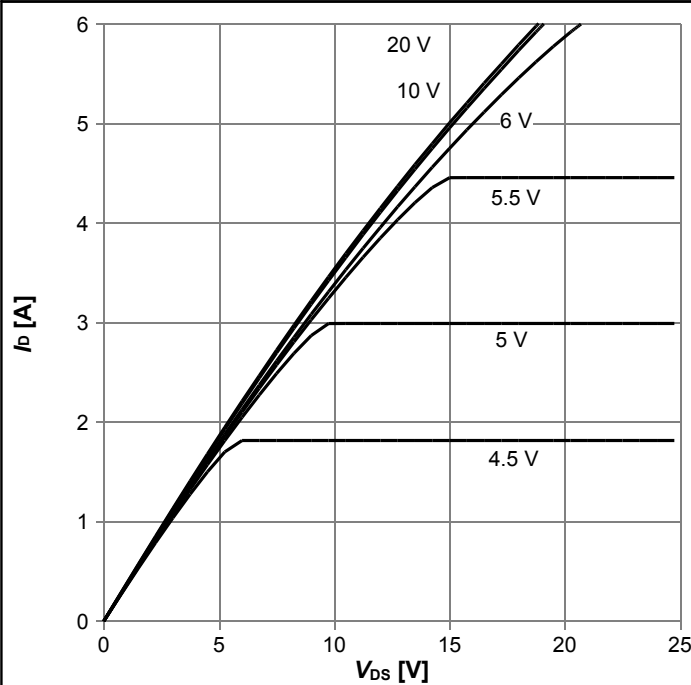
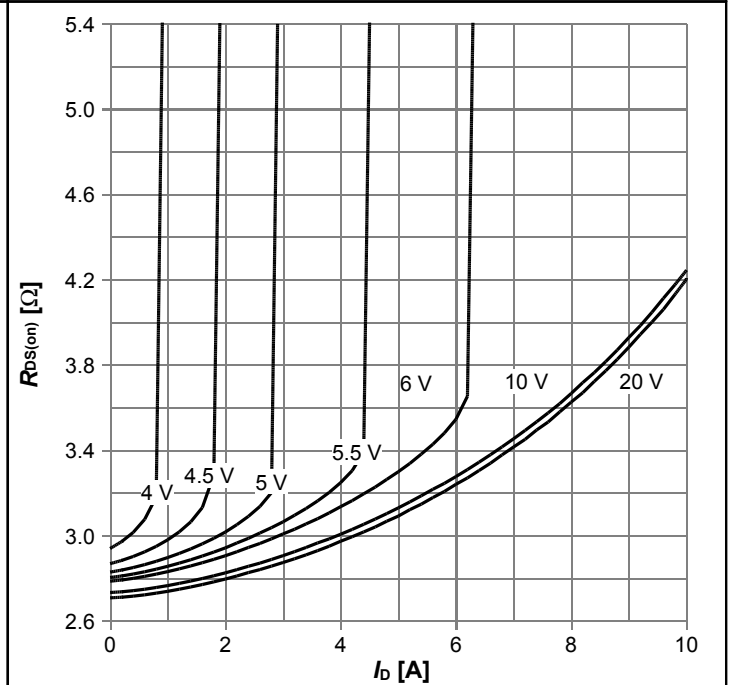


Diagram 5: Typ. output characteristics



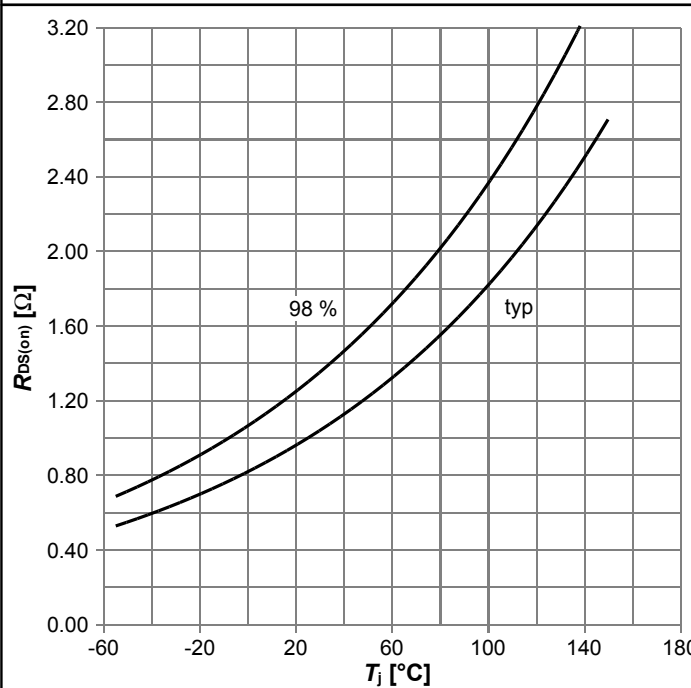
$I_D=f(V_{DS})$ ;  $T_j=150\text{ }^\circ\text{C}$ ;  $t_p=10\text{ }\mu\text{s}$ ; parameter:  $V_{GS}$

Diagram 6: Typ. drain-source on-state resistance



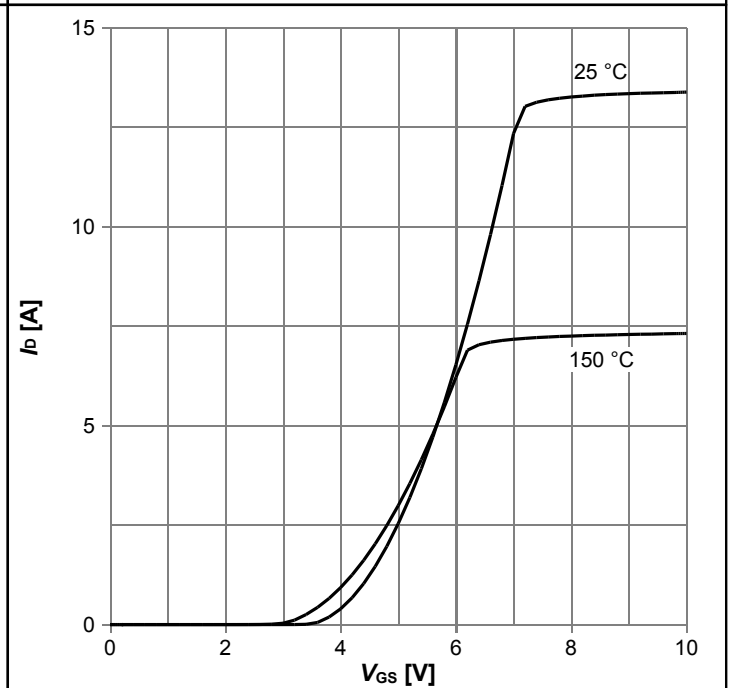
$R_{DS(on)}=f(I_D)$ ;  $T_j=150\text{ }^\circ\text{C}$ ; parameter:  $V_{GS}$

Diagram 7: Drain-source on-state resistance



$R_{DS(on)}=f(T_j)$ ;  $I_D=2.3\text{ A}$ ;  $V_{GS}=10\text{ V}$

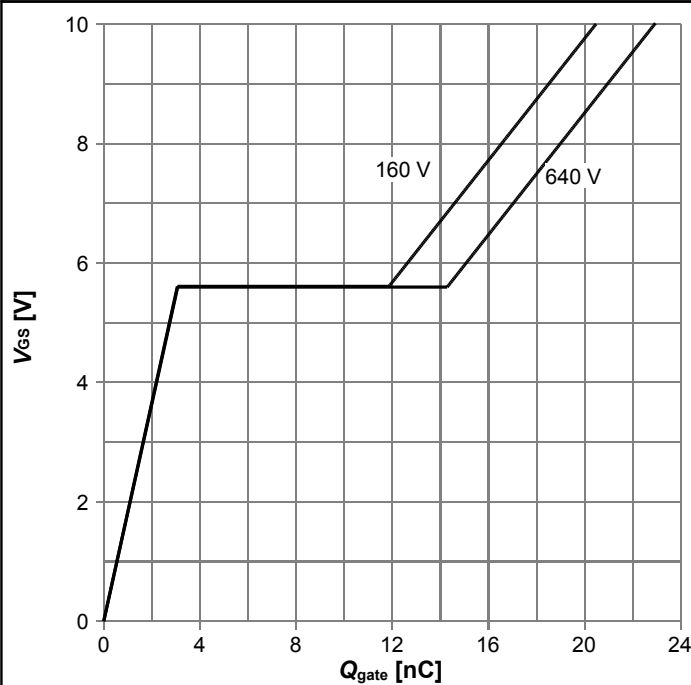
Diagram 8: Typ. transfer characteristics



$I_D=f(V_{GS})$ ;  $|V_{DS}|>2|I_D|R_{DS(on)max}$ ;  $t_p=10\text{ }\mu\text{s}$ ; parameter:  $T_j$

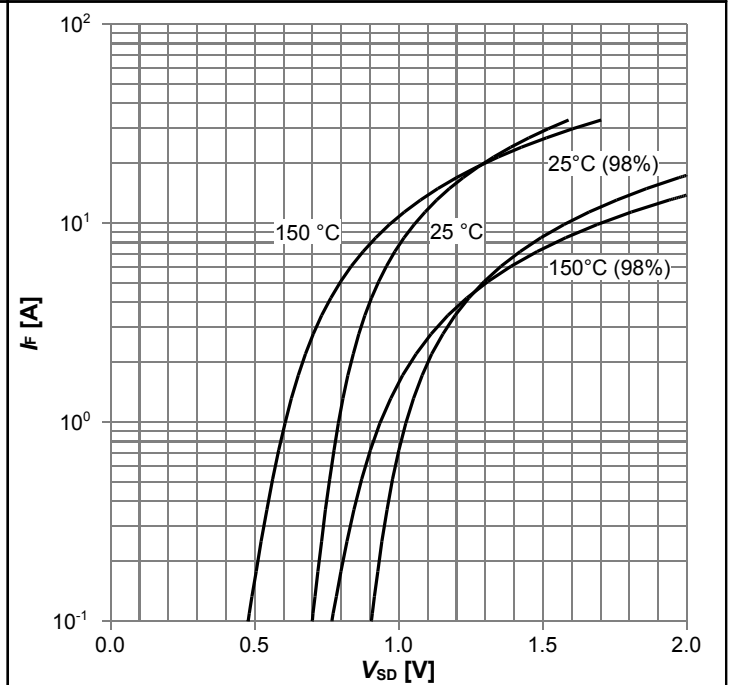


Diagram 9: Typ. gate charge



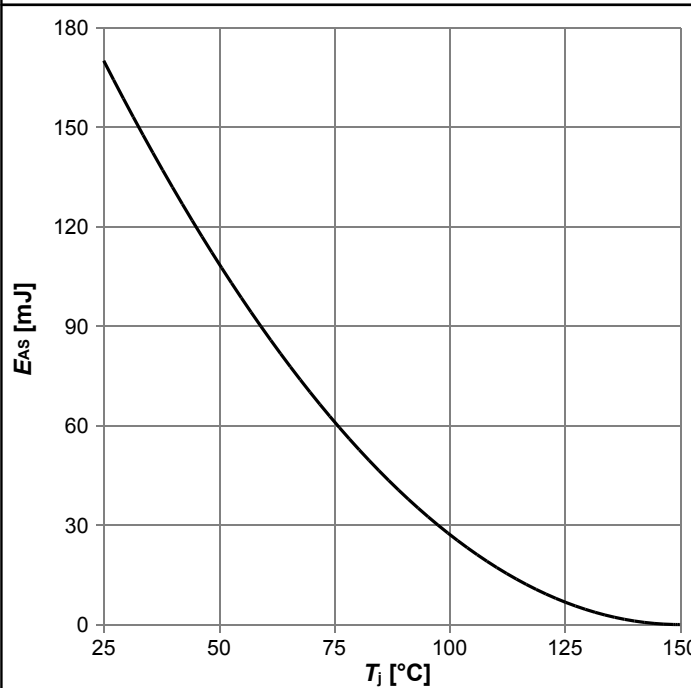
$V_{GS}=f(Q_{gate}); I_D=3.9$  A pulsed; parameter:  $V_{DD}$

Diagram 10: Forward characteristics of reverse diode



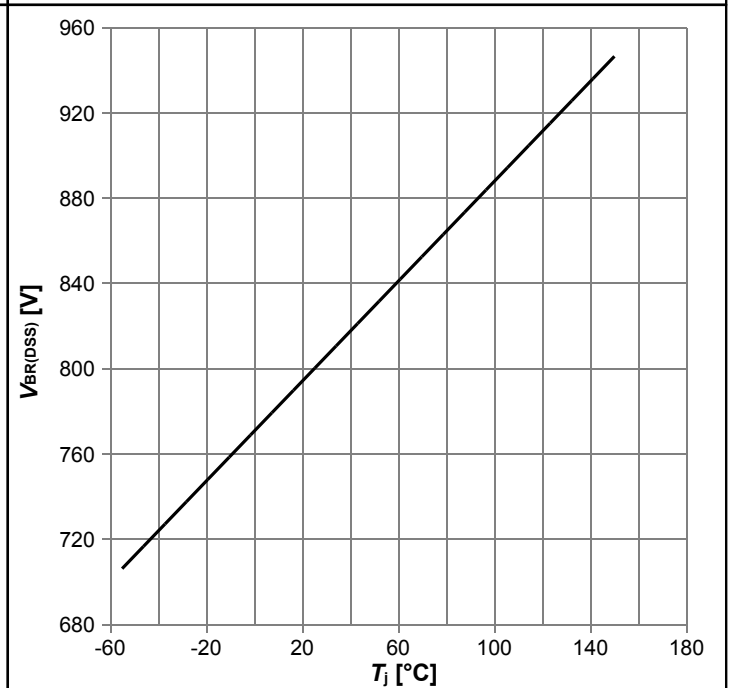
$I_F=f(V_{SD}); t_p=10$   $\mu$ s; parameter:  $T_j$

Diagram 11: Avalanche energy



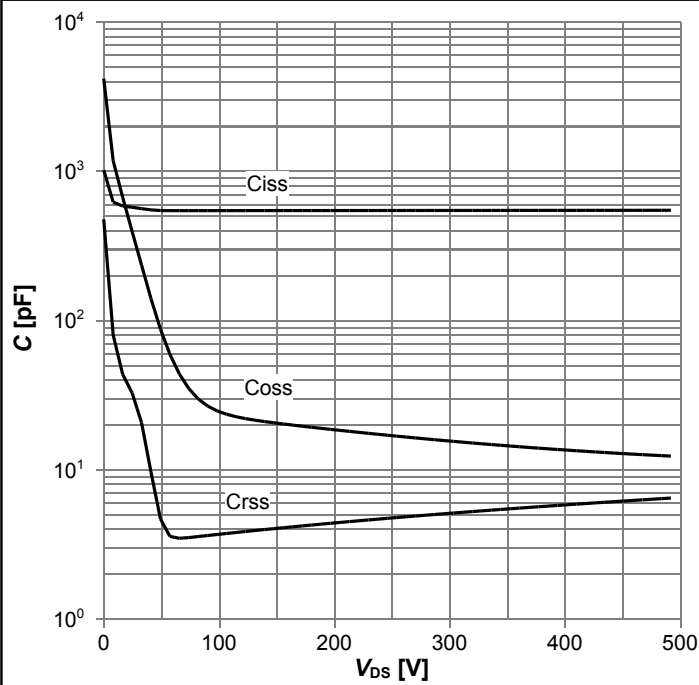
$E_{AS}=f(T_j); I_D=1.2$  A;  $V_{DD}=50$  V

Diagram 12: Drain-source breakdown voltage



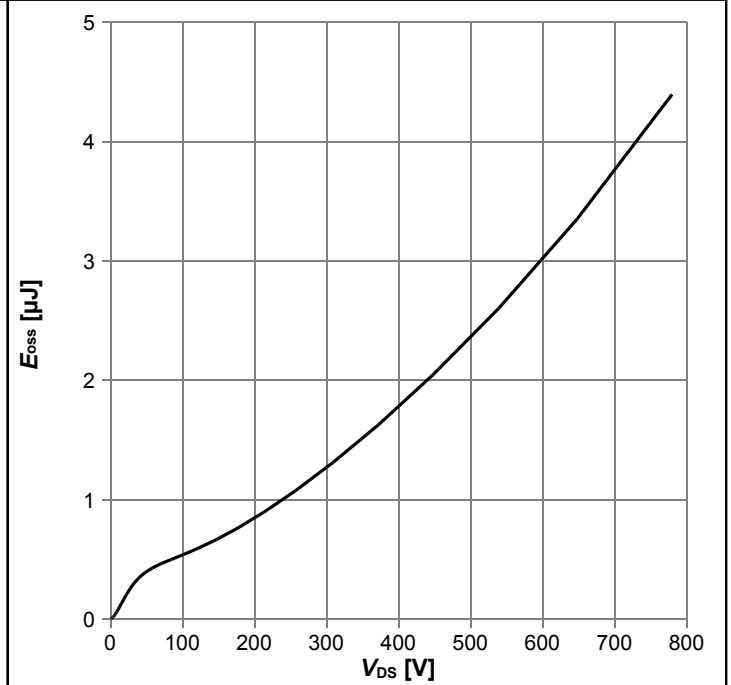
$V_{BR(DSS)}=f(T_j); I_D=0.25$  mA

Diagram 13: Typ. capacitances



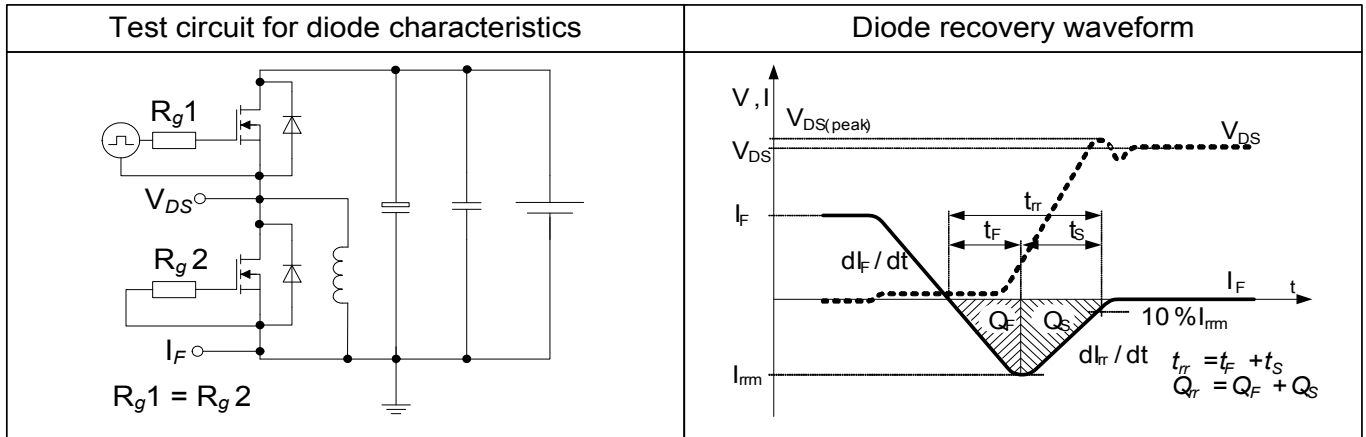
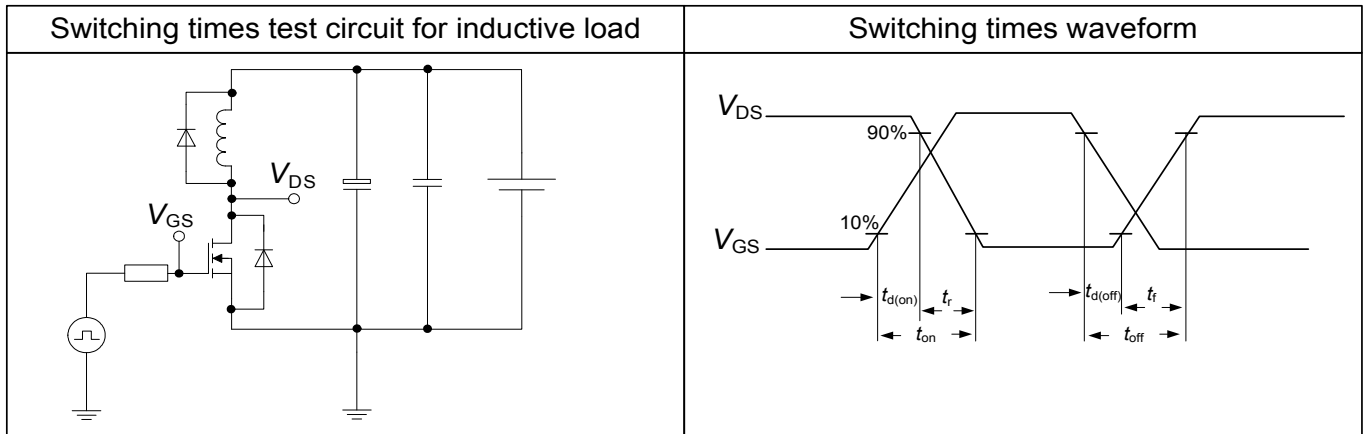
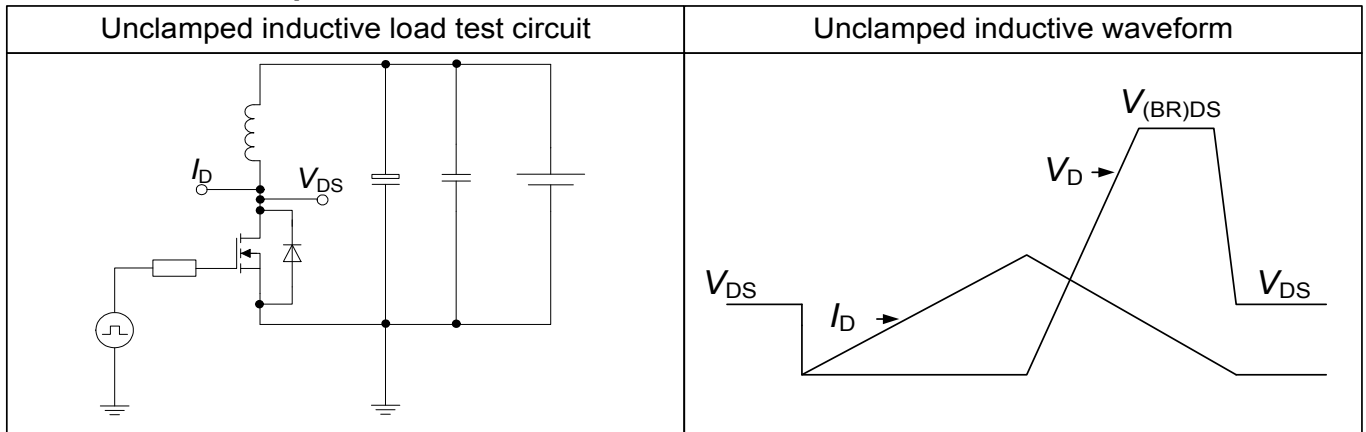
$C=f(V_{DS}); V_{GS}=0\text{ V}; f=1\text{ MHz}$

Diagram 14: Typ. Coss stored energy

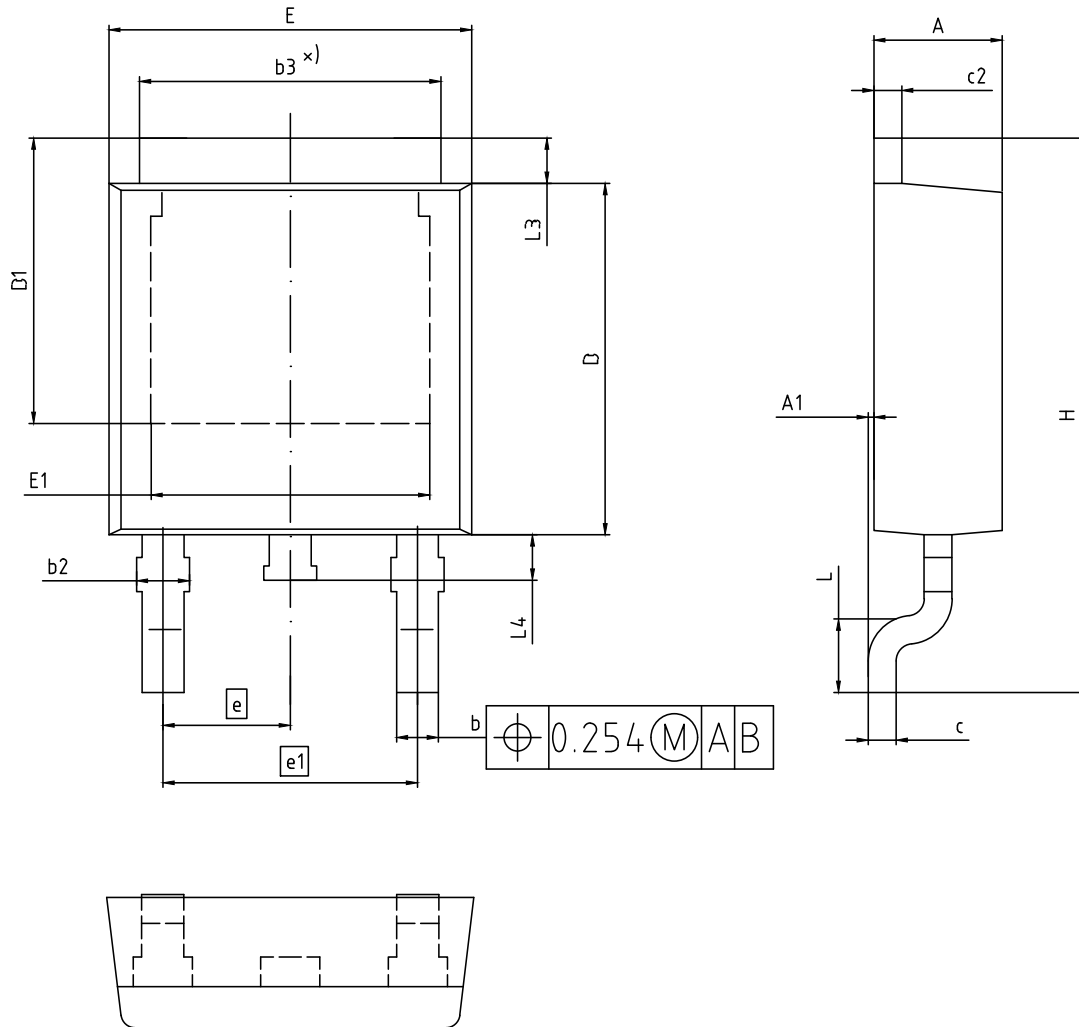


$E_{oss}=f(V_{DS})$

## 6 Test Circuits

**Table 8 Diode characteristics**

**Table 9 Switching times**

**Table 10 Unclamped inductive load**


## 7 Package Outlines

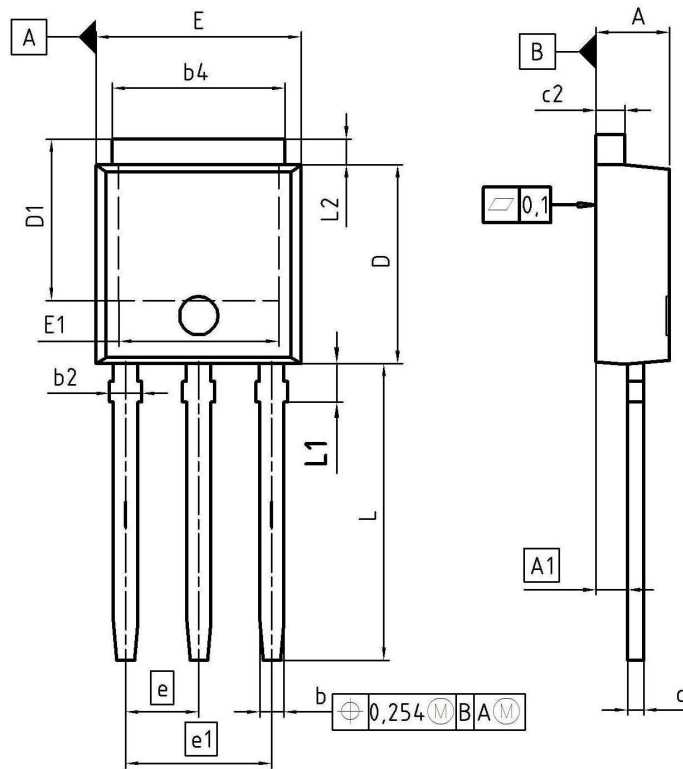


ALL DIMENSIONS REFER TO JEDEC STANDARD TO-252 AND DO NOT INCLUDE MOLD FLASH OR PROTRUSIONS.

DIMENSION	MILLIMETERS	
	MIN.	MAX.
A	2.16	2.41
A1	0.00	0.15
b	0.64	0.89
b2	0.65	1.15
b3	4.95	5.50
c	0.46	0.61
c2	0.40	0.98
D	5.97	6.22
D1	5.02	5.84
E	6.35	6.73
E1	4.32	5.50
e	2.29	
e1	4.57	
N	3	
H	9.40	10.48
L	1.18	1.78
L3	0.89	1.27
L4	0.51	1.02

DOCUMENT NO. Z8B00003328
REVISION 07
SCALE: 10:1 0 1 2mm 
EUROPEAN PROJECTION 
ISSUE DATE 01.04.2020

Figure 1 Outline PG-TO 252, dimensions in mm



DIM	MILLIMETERS		INCHES	
	MIN	MAX	MIN	MAX
A	2.16	2.41	0.085	0.095
A1	0.90	1.14	0.035	0.045
b	0.64	0.89	0.025	0.035
b2	0.65	1.15	0.026	0.045
b4	4.95	5.50	0.195	0.217
c	0.46	0.60	0.018	0.024
c2	0.46	0.89	0.018	0.035
D	5.97	6.22	0.235	0.245
D1	5.04	5.77	0.198	0.227
E	6.35	6.73	0.250	0.265
E1	4.70	5.21	0.185	0.205
e	2.29		0.090	
e1	4.57		0.180	
N	3		3	
L	8.89	9.65	0.350	0.380
L1	1.90	2.29	0.075	0.090
L2	0.89	1.37	0.035	0.054

DOCUMENT NO.  
Z8B00003330

SCALE

EUROPEAN PROJECTION

ISSUE DATE  
19-03-2008

REVISION  
03

Figure 2 Outline PG-TO 251, dimensions in mm/inches

## 8 Appendix A

### Table 11 Related Links

- IFX CoolMOS Webpage: [www.infineon.com](http://www.infineon.com)
- IFX Design tools: [www.infineon.com](http://www.infineon.com)

## Revision History

IPx80R1K4CE

**Revision: 2020-05-26, Rev. 2.3**

Previous Revision

Revision	Date	Subjects (major changes since last revision)
2.0	2013-06-24	Release of final version
2.1	2013-07-18	update to halogen free mold compound
2.2	2016-04-27	Non-halogen free version discontinued
2.3	2020-05-26	Update of the package outlines TO-252

### Trademarks

All referenced product or service names and trademarks are the property of their respective owners.

### We Listen to Your Comments

Any information within this document that you feel is wrong, unclear or missing at all? Your feedback will help us to continuously improve the quality of this document. Please send your proposal (including a reference to this document) to:

[erratum@infineon.com](mailto:erratum@infineon.com)

### Published by

**Infineon Technologies AG**

**81726 München, Germany**

**© 2020 Infineon Technologies AG**

**All Rights Reserved.**

### Legal Disclaimer

The information given in this document shall in no event be regarded as a guarantee of conditions or characteristics ("Beschaffheitsgarantie").

With respect to any examples, hints or any typical values stated herein and/or any information regarding the application of the product, Infineon Technologies hereby disclaims any and all warranties and liabilities of any kind, including without limitation warranties of non-infringement of intellectual property rights of any third party.

In addition, any information given in this document is subject to customer's compliance with its obligations stated in this document and any applicable legal requirements, norms and standards concerning customer's products and any use of the product of Infineon Technologies in customer's applications.

The data contained in this document is exclusively intended for technically trained staff. It is the responsibility of customer's technical departments to evaluate the suitability of the product for the intended application and the completeness of the product information given in this document with respect to such application.

### Information

For further information on technology, delivery terms and conditions and prices please contact your nearest Infineon Technologies Office ([www.infineon.com](http://www.infineon.com)).

### Warnings

Due to technical requirements, components may contain dangerous substances. For information on the types in question, please contact the nearest Infineon Technologies Office.

The Infineon Technologies component described in this Data Sheet may be used in life-support devices or systems and/or automotive, aviation and aerospace applications or systems only with the express written approval of Infineon Technologies, if a failure of such components can reasonably be expected to cause the failure of that life-support, automotive, aviation and aerospace device or system or to affect the safety or effectiveness of that device or system. Life support devices or systems are intended to be implanted in the human body or to support and/or maintain and sustain and/or protect human life. If they fail, it is reasonable to assume that the health of the user or other persons may be endangered.