

# IRF8707PbF

HEXFET® Power MOSFET

## Applications

- Control MOSFET of Sync-Buck Converters used for Notebook Processor Power
- Control MOSFET for Isolated DC-DC Converters in Networking Systems

|                        |                                    |                      |
|------------------------|------------------------------------|----------------------|
| <b>V<sub>DSS</sub></b> | <b>R<sub>DS(on)</sub> max</b>      | <b>Q<sub>g</sub></b> |
| <b>30V</b>             | <b>11.9mΩ@V<sub>GS</sub> = 10V</b> | <b>6.2nC</b>         |

## Benefits

- Very Low Gate Charge
- Very Low R<sub>DS(on)</sub> at 4.5V V<sub>GS</sub>
- Ultra-Low Gate Impedance
- Fully Characterized Avalanche Voltage and Current
- 20V V<sub>GS</sub> Max. Gate Rating
- 100% tested for R<sub>g</sub>
- Lead-Free



## Description

The IRF8707PbF incorporates the latest HEXFET Power MOSFET Silicon Technology into the industry standard SO-8 package. The IRF8707PbF has been optimized for parameters that are critical in synchronous buck operation including R<sub>ds(on)</sub> and gate charge to reduce both conduction and switching losses. The reduced total losses make this product ideal for high efficiency DC-DC converters that power the latest generation of processors for notebook and Netcom applications.

## Absolute Maximum Ratings

|  | Parameter                                       | Max.         | Units |
|--|---|--------------|-------|
| V <sub>DS</sub>                        | Drain-to-Source Voltage                         | 30           | V     |
| V <sub>GS</sub>                        | Gate-to-Source Voltage                          | ± 20         |       |
| I <sub>D</sub> @ T <sub>A</sub> = 25°C | Continuous Drain Current, V <sub>GS</sub> @ 10V | 11           | A     |
| I <sub>D</sub> @ T <sub>A</sub> = 70°C | Continuous Drain Current, V <sub>GS</sub> @ 10V | 9.1          |       |
| I <sub>DM</sub>                        | Pulsed Drain Current ①                          | 88           |       |
| P <sub>D</sub> @ T <sub>A</sub> = 25°C | Power Dissipation                               | 2.5          | W     |
| P <sub>D</sub> @ T <sub>A</sub> = 70°C | Power Dissipation                               | 1.6          |       |
|  | Linear Derating Factor                          | 0.02         | W/°C  |
| T <sub>J</sub>                         | Operating Junction and                          | -55 to + 150 | °C    |
| T <sub>STG</sub>                       | Storage Temperature Range                       |              |       |

## Thermal Resistance

|                  | Parameter                | Typ. | Max. | Units |
|------------------|--------------------------|------|------|-------|
| R <sub>θJL</sub> | Junction-to-Drain Lead ⑤ | —    | 20   | °C/W  |
| R <sub>θJA</sub> | Junction-to-Ambient ⑥⑤   | —    | 50   |       |

Notes ① through ⑤ are on page 9

www.irf.com

# IRF8707PbF

International  
IR Rectifier

Static @  $T_J = 25^\circ\text{C}$  (unless otherwise specified)

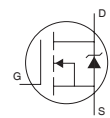
|                              | Parameter                            | Min. | Typ.  | Max. | Units | Conditions  |
|------------------------------|--------------------------------------|------|-------|------|-------|---|
| $BV_{DSS}$                   | Drain-to-Source Breakdown Voltage    | 30   | —     | —    | V     | $V_{GS} = 0V, I_D = 250\mu A$   |
| $\Delta BV_{DSS}/\Delta T_J$ | Breakdown Voltage Temp. Coefficient  | —    | 0.022 | —    | V/°C  | Reference to $25^\circ\text{C}, I_D = 1\text{mA}$                                 |
| $R_{DS(on)}$                 | Static Drain-to-Source On-Resistance | —    | 9.3   | 11.9 | mΩ    | $V_{GS} = 10V, I_D = 11A$ ③   |
|                              |                                      | —    | 14.2  | 17.5 |       | $V_{GS} = 4.5V, I_D = 8.8A$ ③   |
| $V_{GS(th)}$                 | Gate Threshold Voltage               | 1.35 | 1.80  | 2.35 | V     | $V_{DS} = V_{GS}, I_D = 25\mu A$  |
| $\Delta V_{GS(th)}$          | Gate Threshold Voltage Coefficient   | —    | -5.8  | —    | mV/°C | $V_{DS} = V_{GS}, I_D = 25\mu A$  |
| $I_{DSS}$                    | Drain-to-Source Leakage Current      | —    | —     | 1.0  | μA    | $V_{DS} = 24V, V_{GS} = 0V$   |
|                              |                                      | —    | —     | 150  |       | $V_{DS} = 24V, V_{GS} = 0V, T_J = 125^\circ\text{C}$                              |
| $I_{GSS}$                    | Gate-to-Source Forward Leakage       | —    | —     | 100  | nA    | $V_{GS} = 20V$  |
|                              | Gate-to-Source Reverse Leakage       | —    | —     | -100 |       | $V_{GS} = -20V$   |
| $g_{fs}$                     | Forward Transconductance             | 25   | —     | —    | S     | $V_{DS} = 15V, I_D = 8.8A$  |
| $Q_g$                        | Total Gate Charge                    | —    | 6.2   | 9.3  | nC    | $V_{DS} = 15V$<br>$V_{GS} = 4.5V$<br>$I_D = 8.8A$<br>See Figs. 15 & 16            |
| $Q_{gs1}$                    | Pre-Vth Gate-to-Source Charge        | —    | 1.4   | —    |       |   |
| $Q_{gs2}$                    | Post-Vth Gate-to-Source Charge       | —    | 0.7   | —    |       |   |
| $Q_{gd}$                     | Gate-to-Drain Charge                 | —    | 2.2   | —    |       |   |
| $Q_{godr}$                   | Gate Charge Overdrive                | —    | 1.9   | —    |       |   |
| $Q_{sw}$                     | Switch Charge ( $Q_{gs2} + Q_{gd}$ ) | —    | 2.9   | —    |       |   |
| $Q_{oss}$                    | Output Charge                        | —    | 3.7   | —    | nC    | $V_{DS} = 16V, V_{GS} = 0V$   |
| $R_g$                        | Gate Resistance                      | —    | 2.2   | 3.5  | Ω     |   |
| $t_{d(on)}$                  | Turn-On Delay Time                   | —    | 6.7   | —    | ns    | $V_{DD} = 15V, V_{GS} = 4.5V$<br>$I_D = 8.8A$<br>$R_G = 1.8\Omega$<br>See Fig. 18 |
| $t_r$                        | Rise Time                            | —    | 7.9   | —    |       |   |
| $t_{d(off)}$                 | Turn-Off Delay Time                  | —    | 7.3   | —    |       |   |
| $t_f$                        | Fall Time                            | —    | 4.4   | —    |       |   |
| $C_{iss}$                    | Input Capacitance                    | —    | 760   | —    | pF    | $V_{GS} = 0V$<br>$V_{DS} = 15V$<br>$f = 1.0\text{MHz}$                            |
| $C_{oss}$                    | Output Capacitance                   | —    | 170   | —    |       |   |
| $C_{rss}$                    | Reverse Transfer Capacitance         | —    | 82    | —    |       |   |

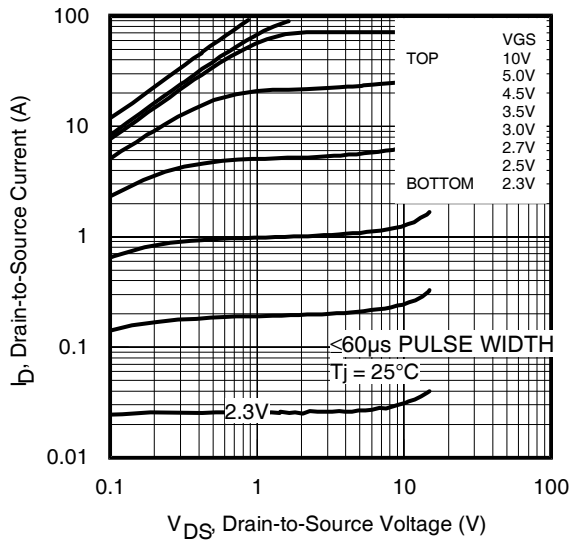
## Avalanche Characteristics

|          | Parameter                       | Typ. | Max. | Units |
|----------|---------------------------------|------|------|-------|
| $E_{AS}$ | Single Pulse Avalanche Energy ② | —    | 53   | mJ    |
| $I_{AR}$ | Avalanche Current ①             | —    | 8.8  | A     |

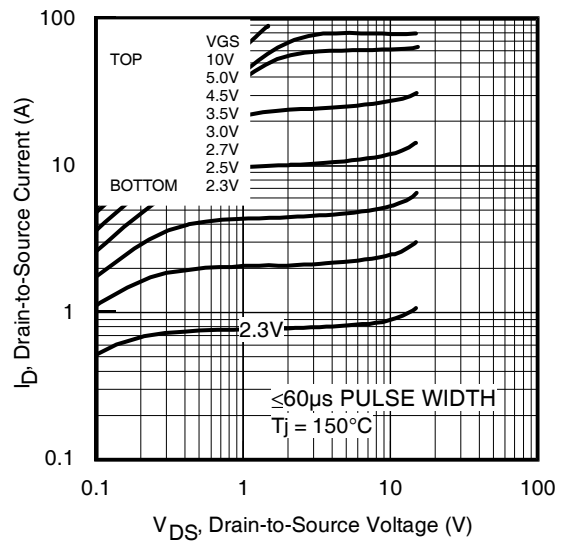
## Diode Characteristics

|          | Parameter                                 | Min.   | Typ. | Max. | Units | Conditions  |
|----------|---|--|------|------|-------|---|
| $I_S$    | Continuous Source Current<br>(Body Diode) | —  | —    | 3.1  | A     | MOSFET symbol<br>showing the<br>integral reverse<br>p-n junction diode. |
| $I_{SM}$ | Pulsed Source Current<br>(Body Diode) ①   | —  | —    | 88   | A     |   |
| $V_{SD}$ | Diode Forward Voltage                     | —  | —    | 1.0  | V     | $T_J = 25^\circ\text{C}, I_S = 8.8A, V_{GS} = 0V$ ③                     |
| $t_{rr}$ | Reverse Recovery Time                     | —  | 12   | 18   | ns    | $T_J = 25^\circ\text{C}, I_F = 8.8A, V_{DD} = 15V$                      |
| $Q_{rr}$ | Reverse Recovery Charge                   | —  | 13   | 20   | nC    | $di/dt = 300A/\mu s$ ③  |
| $t_{on}$ | Forward Turn-On Time                      | Intrinsic turn-on time is negligible (turn-on is dominated by LS+LD) |      |      |       |   |

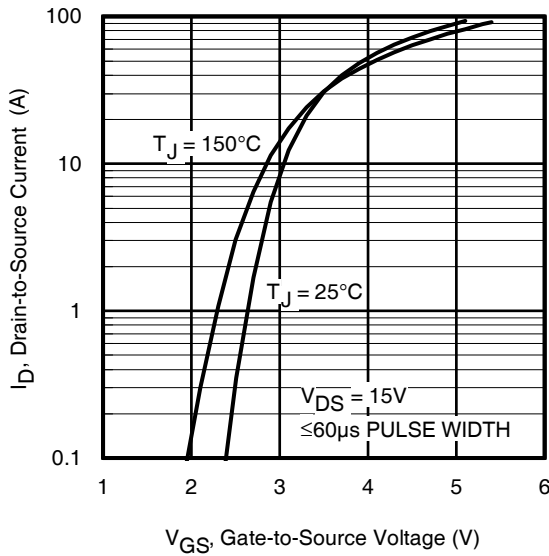




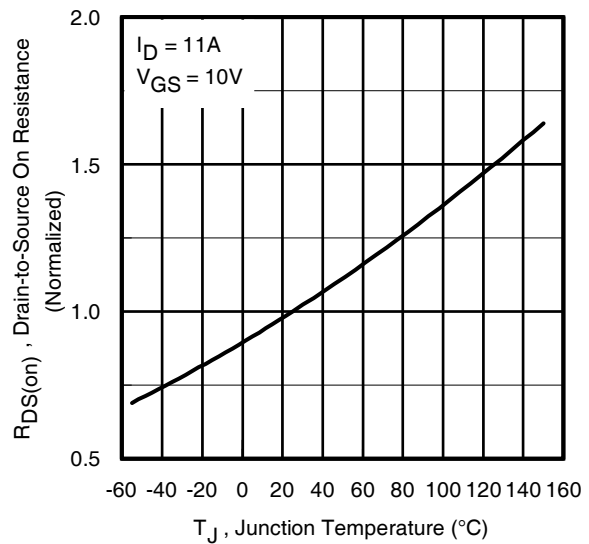
**Fig 1.** Typical Output Characteristics



**Fig 2.** Typical Output Characteristics

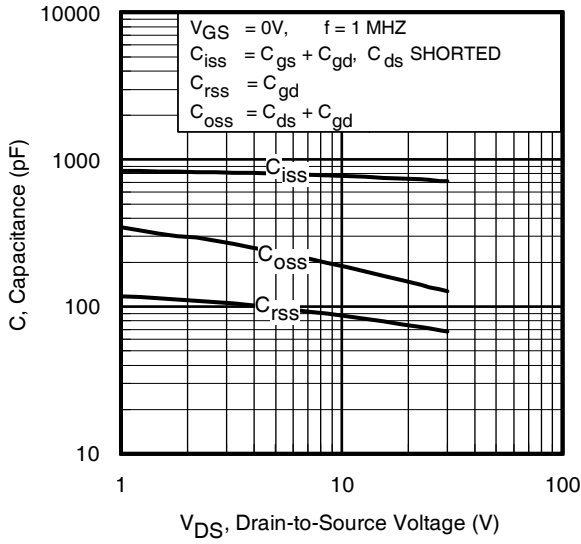


**Fig 3.** Typical Transfer Characteristics

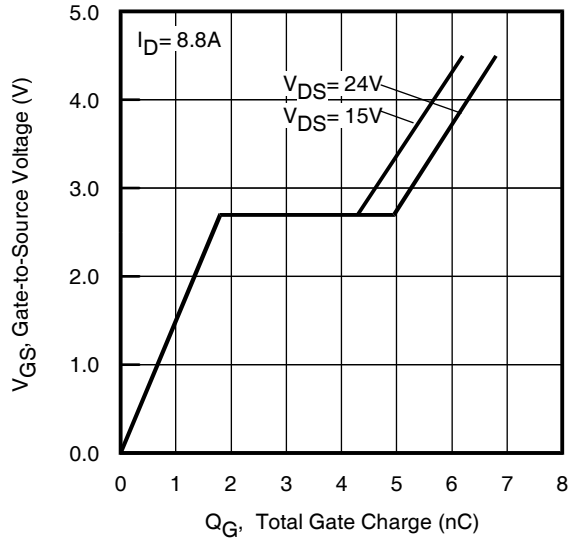


**Fig 4.** Normalized On-Resistance vs. Temperature

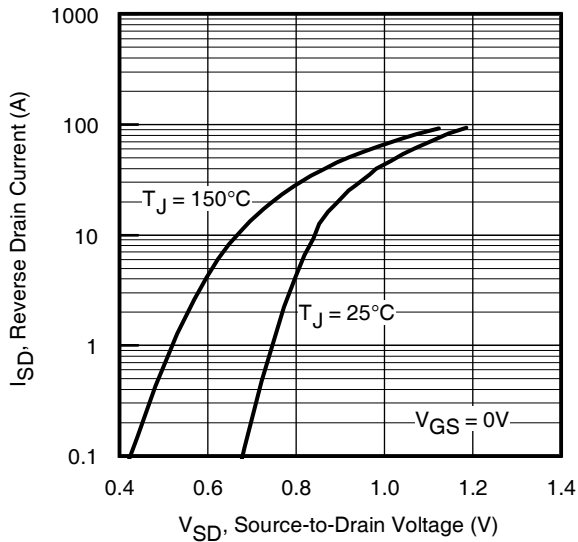
# IRF8707PbF



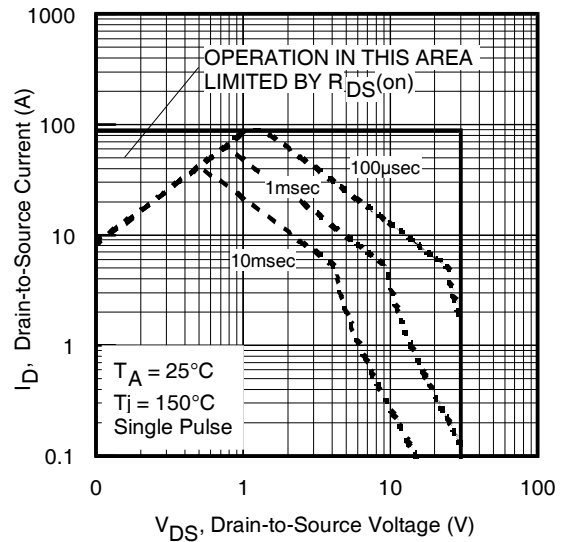
**Fig 5.** Typical Capacitance vs. Drain-to-Source Voltage



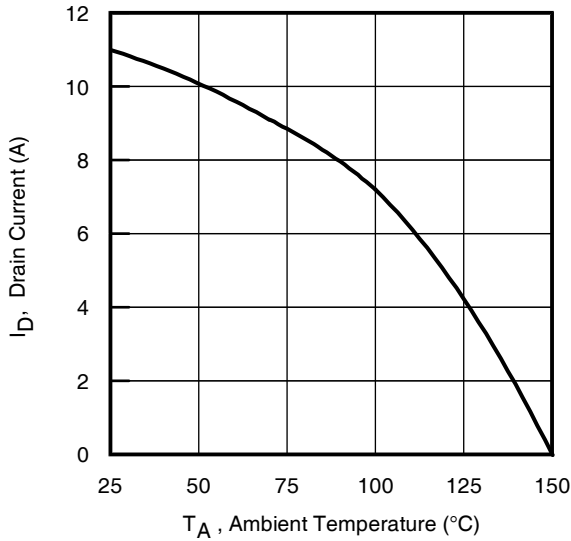
**Fig 6.** Typical Gate Charge Vs. Gate-to-Source Voltage



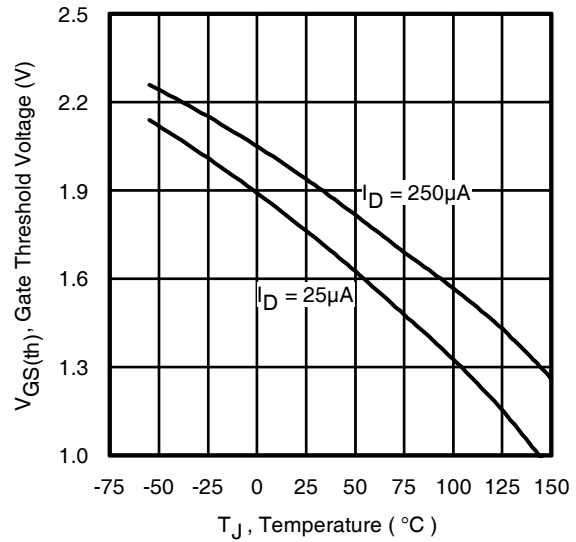
**Fig 7.** Typical Source-Drain Diode Forward Voltage



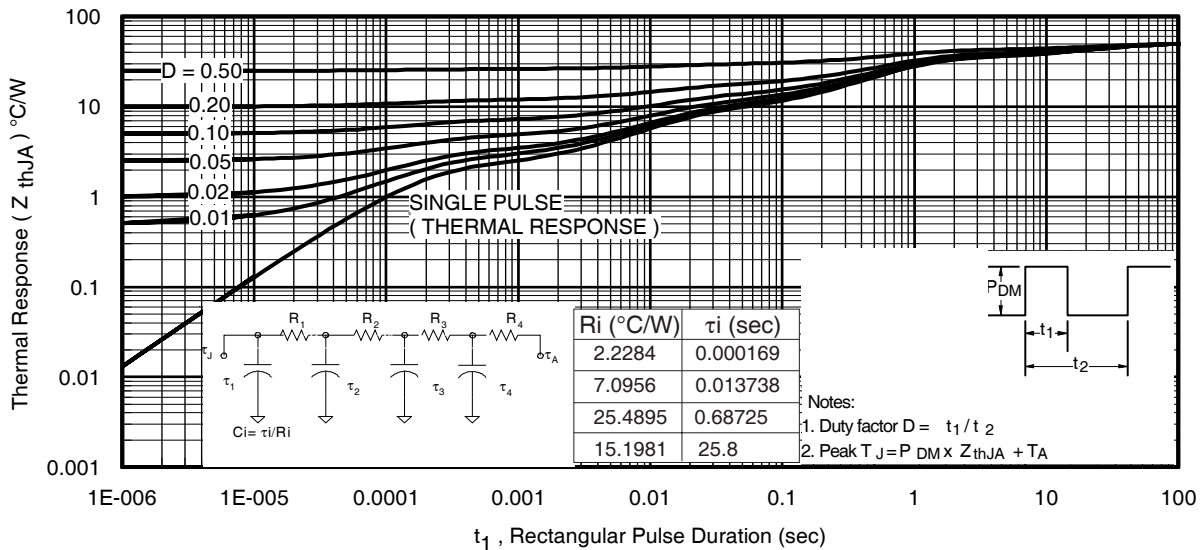
**Fig 8.** Maximum Safe Operating Area



**Fig 9.** Maximum Drain Current vs. Ambient Temperature



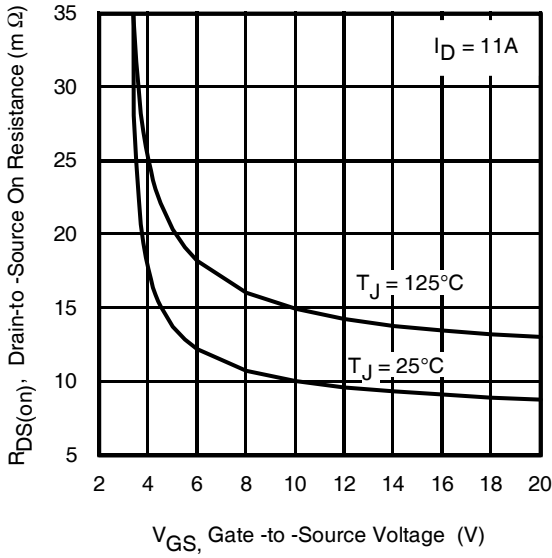
**Fig 10.** Threshold Voltage vs. Temperature



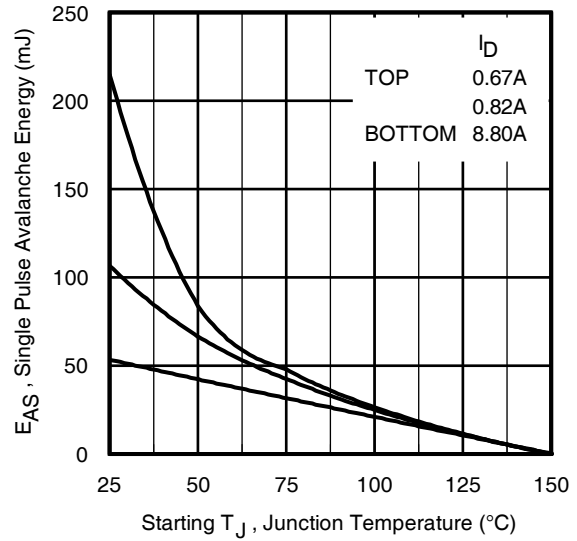
**Fig 11.** Maximum Effective Transient Thermal Impedance, Junction-to-Ambient

# IRF8707PbF

International  
**IR** Rectifier



**Fig 12.** On-Resistance vs. Gate Voltage



**Fig 13.** Maximum Avalanche Energy vs. Drain Current



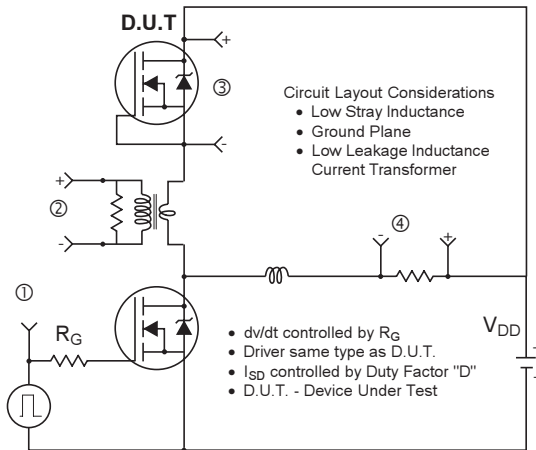
**Fig 14.** Unclamped Inductive Test Circuit and Waveform



**Fig 15.** Gate Charge Test Circuit

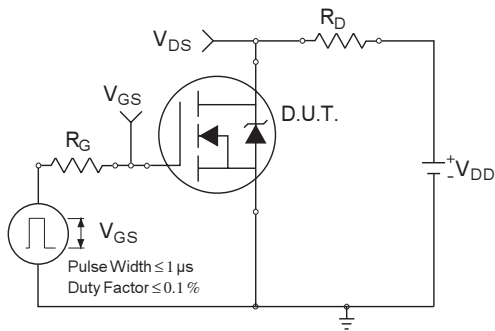


**Fig 16.** Gate Charge Waveform



\*  $V_{GS} = 5V$  for Logic Level Devices

**Fig 17. Peak Diode Recovery dv/dt Test Circuit for N-Channel HEXFET® Power MOSFETS**



**Fig 18a. Switching Time Test Circuit**



**Fig 18b. Switching Time Waveforms**

# IRF8707PbF

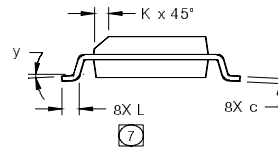
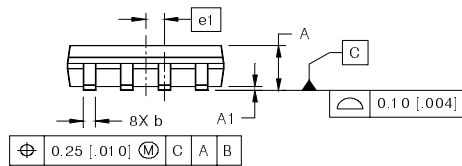
## SO-8 Package Outline

International  
**IR** Rectifier

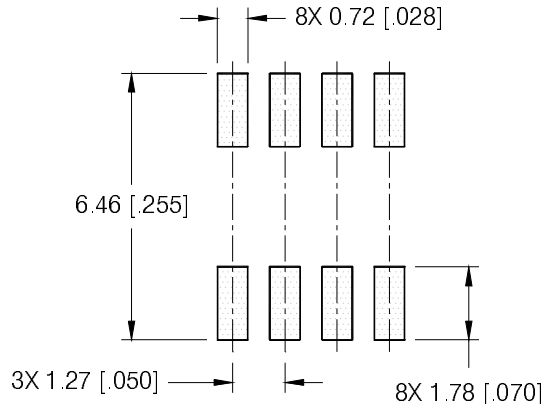
Dimensions are shown in millimeters (inches)



| DIM | INCHES     |       | MILLIMETERS |      |
|-----|------------|-------|-------------|------|
|     | MIN        | MAX   | MIN         | MAX  |
| A   | .0532      | .0688 | 1.35        | 1.75 |
| A1  | .0040      | .0098 | 0.10        | 0.25 |
| b   | .013       | .020  | 0.33        | 0.51 |
| c   | .0075      | .0098 | 0.19        | 0.25 |
| D   | .189       | .1968 | 4.80        | 5.00 |
| E   | .1497      | .1574 | 3.80        | 4.00 |
| e   | .050 BASIC |       | 1.27 BASIC  |      |
| e1  | .025 BASIC |       | 0.635 BASIC |      |
| H   | .2284      | .2440 | 5.80        | 6.20 |
| K   | .0099      | .0196 | 0.25        | 0.50 |
| L   | .016       | .050  | 0.40        | 1.27 |
| y   | 0°         | 8°    | 0°          | 8°   |



### FOOTPRINT

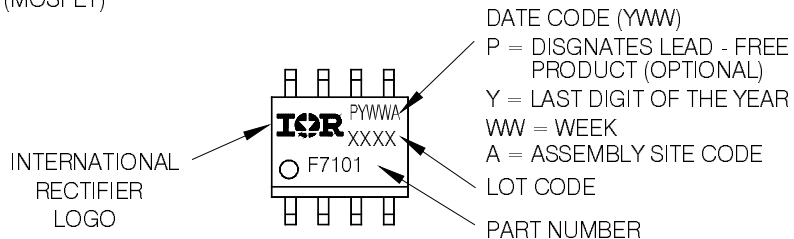


#### NOTES:

1. DIMENSIONING & TOLERANCING PER ASME Y14.5M-1994.
2. CONTROLLING DIMENSION: MILLIMETER
3. DIMENSIONS ARE SHOWN IN MILLIMETERS [INCHES].
4. OUTLINE CONFORMS TO JEDEC OUTLINE MS-012AA.
- ⑤ DIMENSION DOES NOT INCLUDE MOLD PROTRUSIONS. MOLD PROTRUSIONS NOT TO EXCEED 0.15 [0.006].
- ⑥ DIMENSION DOES NOT INCLUDE MOLD PROTRUSIONS. MOLD PROTRUSIONS NOT TO EXCEED 0.25 [0.010].
- ⑦ DIMENSION IS THE LENGTH OF LEAD FOR SOLDERING TO A SUBSTRATE.

## SO-8 Part Marking Information

EXAMPLE: THIS IS AN IRF7101 (MOSFET)

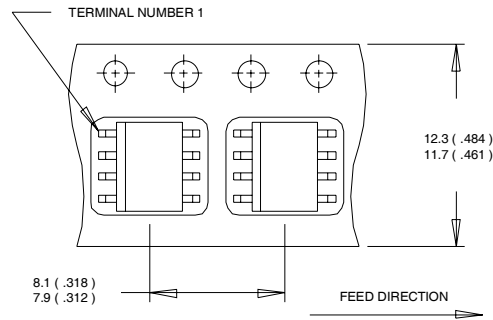


Note: For the most current drawing please refer to IR website at <http://www.irf.com/package>



## SO-8 Tape and Reel

Dimensions are shown in millimeters (inches)



- NOTES:
1. CONTROLLING DIMENSION : MILLIMETER.
  2. ALL DIMENSIONS ARE SHOWN IN MILLIMETERS(INCHES).
  3. OUTLINE CONFORMS TO EIA-481 & EIA-541.



- NOTES:
1. CONTROLLING DIMENSION : MILLIMETER.
  2. OUTLINE CONFORMS TO EIA-481 & EIA-541.

**Notes:**

- ① Repetitive rating; pulse width limited by max. junction temperature.
- ② Starting  $T_J = 25^\circ\text{C}$ ,  $L = 1.38\text{mH}$ ,  $R_G = 25\Omega$ ,  $I_{AS} = 8.8\text{A}$ .
- ③ Pulse width  $\leq 400\mu\text{s}$ ; duty cycle  $\leq 2\%$ .
- ④ When mounted on 1 inch square copper board.
- ⑤  $R_\theta$  is measured at  $T_J$  of approximately  $90^\circ\text{C}$ .

**Note: For the most current drawing please refer to IR website at <http://www.irf.com/package>**

Data and specifications subject to change without notice.

This product has been designed and qualified for the Consumer market.

Qualification Standards can be found on IR's Web site.