

ASSEMBLY

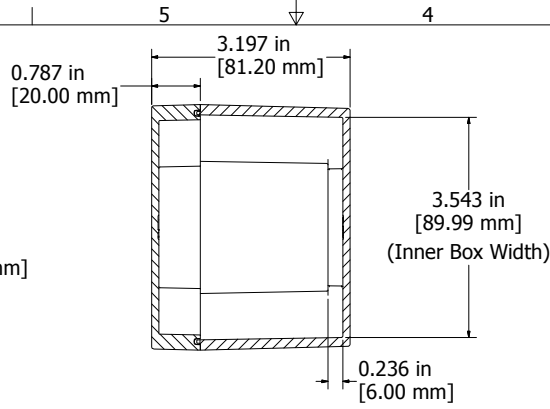

SECTION A-A
End View of Assembly

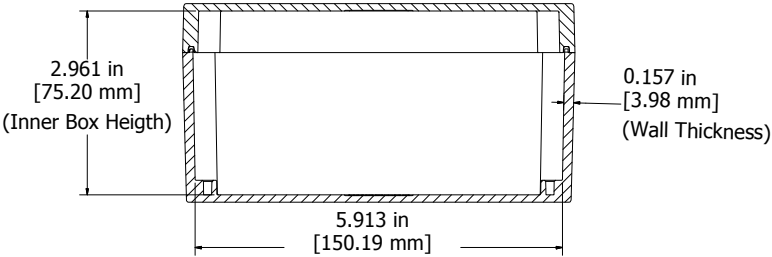
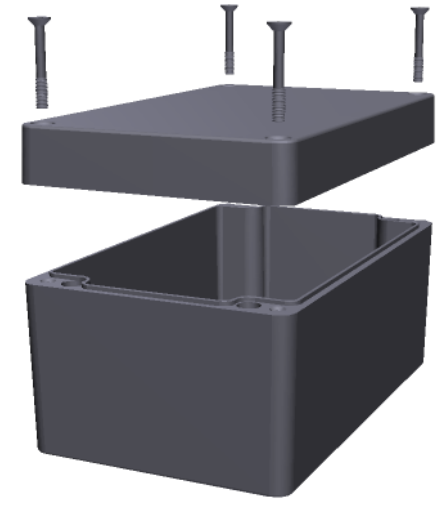

SECTION B-B
Side View of Assembly

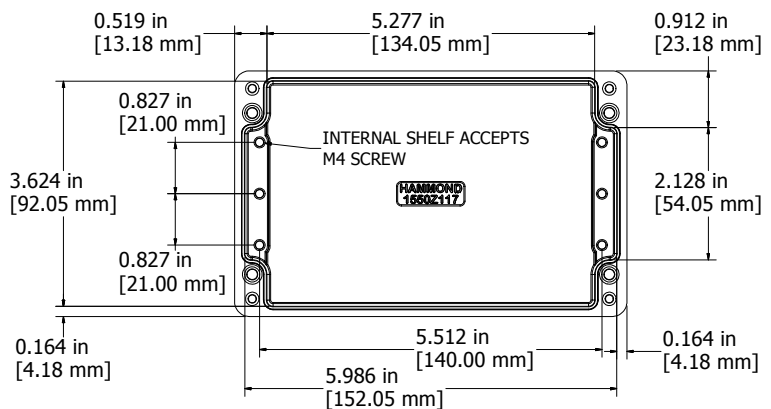

Top View Looking Inside Box

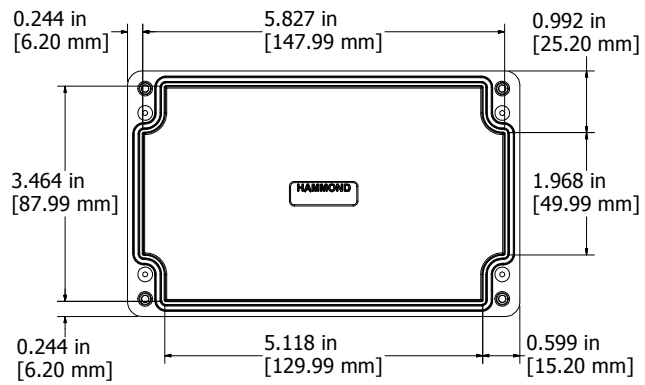

View Looking Inside Lid

UL US LISTED
File #E71073
NEMA 4, 4X

Enclosures can be Factory Modified (Milling, Drilling, Printing etc.)
Contact Factory mjm@hammondmfg.com for quotes
Solid models of this enclosure available in STEP or IGES.

NOTES	
Purchased assembly includes enclosure, M4x30 lid screws and Pre-formed Silicone Gasket	
Cover screws should be torqued to 5-7.5 lbf.in (50-75 cN.m)	

1550Z117	
PART NUMBERS	
Natural Finish Enclosure	1550Z117
Black Textured Enclosure	1550Z117BK

HAMMOND MANUFACTURING™
1550Z117
www.hammondmfg.com