

DF63SF Series

# 12A Max. 3.96mm Pitch, Wire-to-Board Connectors



Power Supply



Compact



Vertical/Side Cable

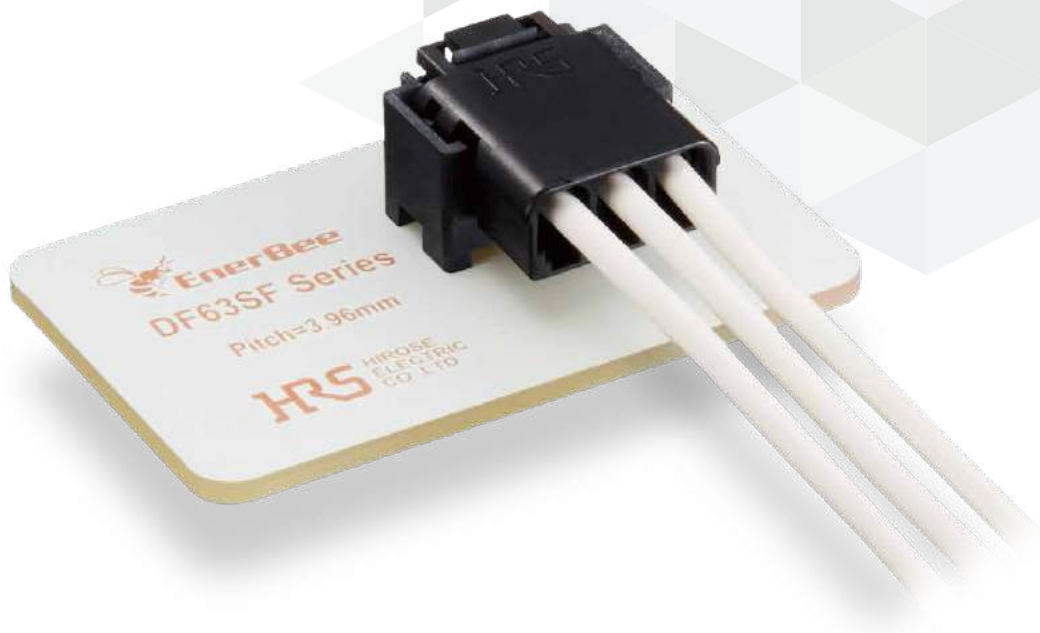

## Features

### 1. Rated for up to 12A

DF63SF has the capacity to handle a Max. of 12A when using 16 AWG wire.

(Please refer to the specification chart of the rated current when using other cables.)

### 2. The small vertical-mating design allows for easy assembly

Vertical mating and horizontal wiring (Side Feed) enable high flexibility in component arrangement and reduces work space.

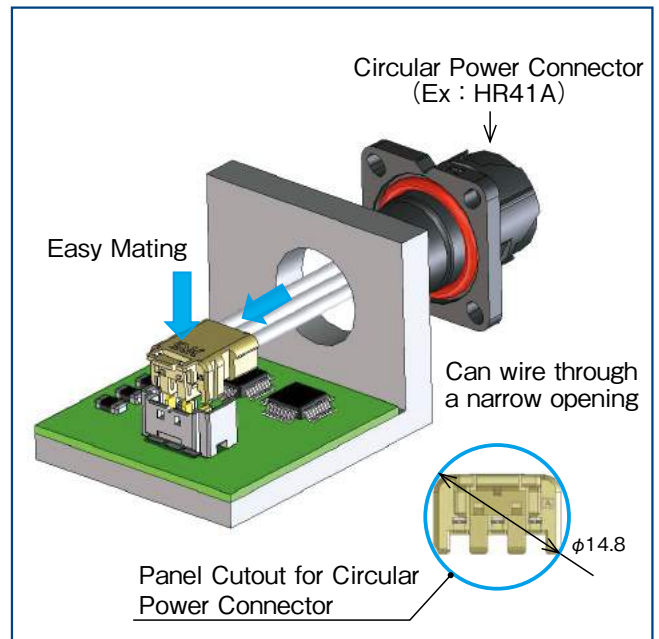

Small Size and Vertical Mating

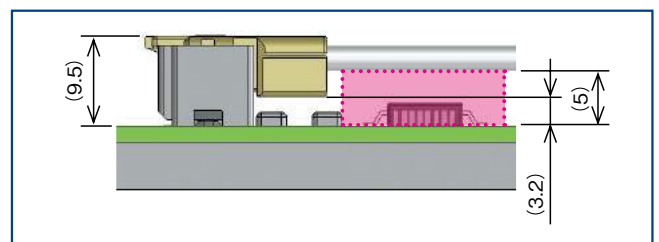

Minimized keep-out space

Other components can be mounted under the cables

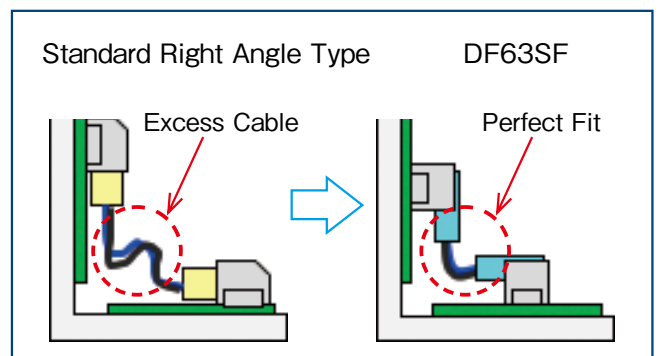

### 3. Secure Mating with a Clear Tactile Click

The design secures a large enough space to press down the socket at the center. Mating is confirmed by the clear tactile click.

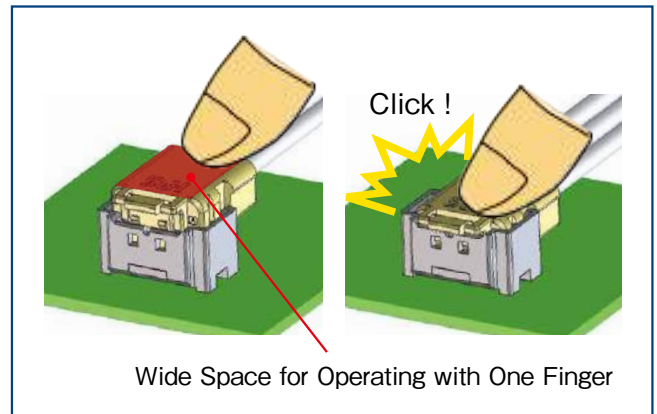

Secure Mating

### 4. Molded Lance Design

The molded lance design prevents deformation due to contact entanglement.

### 5. THR Mounting

Compatible with automatic mounting machine and contributes to improving productivity.

### 6. Glow Wire compliance (Compliant with IEC 60695-2-11)

### 7. Supports 7.92mm pitch

Also supports 7.92mm pitch with 2pos. by skipped pin. (removing middle pin of 3pos. product)

## Product Specifications

Rated Current (Note 1)	No. of Pos.	16 AWG	18 AWG	Operating Temperature (Note 2)	-55 to +105°C
	3	12A	10A	Storage Temperature Range (Note 3)	-10 to +60°C
	2 (7.92mm Pitch)	15A	13A	Operating Humidity Range (Note 4)	20 to 80%
Rated Voltage	630V AC/DC			Storage Humidity Range (Note 3)	40 to 70%

Rated Voltage	UL	600V AC/DC
	C-UL	
	TÜV	300V AC/DC

UL/TÜV File No. and Recognition No.

UL : E52653

C-UL : E52653

TÜV : R50372836

Item	Specifications	Conditions
Insulation Resistance	No less than 1,000M $\Omega$	Measured at 500V DC
Withstand Voltage	No flashover or breakdown	2,200V AC is applied for 1 min.
Contact Resistance	No more than 10m $\Omega$	Measured at 1mA (DC or 1000Hz) and no higher than 20mV
Vibration Resistance	No electrical discontinuity of 1 $\mu$ s or greater	Frequency 10-55Hz, half amplitude 0.75mm, 10 times in each of the three directions
Shock Resistance	No electrical discontinuity of 1 $\mu$ s or greater	Accelerated velocity : 490 m/s <sup>2</sup> for 11ms, half-sine wave in 3 directions, 3 times for each direction
Moisture-resistance	Contact resistance : no more than 20m $\Omega$ Insulation resistance : no less than 500M $\Omega$	Temperature : 40 $\pm$ 2°C ; humidity : 90 to 95%, left as it is for 96 hours
Temperature Cycles	Contact resistance : no more than 20m $\Omega$ Insulation resistance : no less than 1,000M $\Omega$	-55°C : 30 minutes $\rightarrow$ 85°C : 30 minutes 5 cycles
Mating Durability	Contact resistance : no more than 20m $\Omega$	50 mating cycles
Solder Heat Resistance	The resin parts should withstand the temperature and resist melting.	Reflow : according to the Recommended Temperature Profile Hand soldering : temperature of soldering iron at 350°C $\pm$ 10°C for 5 seconds

Note 1 : This is the maximum current rating while all pins are powered or used as all power lines.

Note 2 : Includes temperature rise due to current flow.

Note 3 : The storage condition refers to long-term storage of the product on the shelf before assembly.

Please use the operating temperature for temporary storage such as pre-assembly and during shipping.

Note 4 : Use without condensation on parts.

## Materials / Finish

Component	Part	Material	Finish	UL Specification
Header	Insulator	LCP	Black	UL94V-0
	Contact	Copper Alloy	Gold Plated	-
Crimp Socket	Insulator	PBT (glass-reinforced)	Black	UL94V-0
Crimp Contact	Contact	Copper Alloy	Gold Plated	-

## Product Number Structure

Refer to the chart below when determining the product specifications from the product number.  
Please select from the product numbers listed in this catalog when placing orders.

### Header

**DF63SF - # P - 3.96 TV**

①      ② ③      ④      ⑤

① Series Name	DF63SF	④ Contact Pitch	3.96mm 7.92mm
② No. of Pos.	2,3		
③ Connector Type	P : Header	⑤ Termination Style	TV : THR vertical type

### Crimp Socket

**DF63SF - # S - 3.96 C**

①      ② ③      ④      ⑤

① Series Name	DF63SF	③ Connector Type	S : Crimp socket
② No. of Pos.	3	④ Contact Pitch	3.96mm
		⑤ Termination Style	C : Crimp housing

### Crimp Contact

**DF63SF - 1618 SCFA**

①      ②

① Applicable Conductor	1618 : 16 to 18 AWG	② Packaging	SCFA : Socket Contacts/Reel/Gold Plated
------------------------	---------------------	-------------	---

## Straight Header (THR)

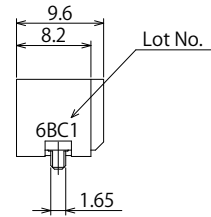
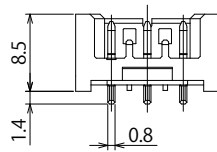
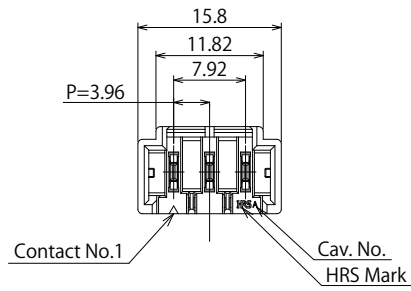

Part No.	HRS No.	No. of Pos.	Specification No.		Purchase Unit
			(51)	(52)	
DF63SF-3P-3.96TV(##)	CL0680-0701-0-##	3	○	○	450pcs per reel
DF63SF-2P-7.92TV(##)	CL0680-0704-0-##	2	×	○	

[Specification number] (##)

(51) : Gold plated(0.2 μ m), embossed packaging

(52) : Gold plated(0.76 μ m), embossed packaging

● Recommended PCB Layout (t=1.6mm)

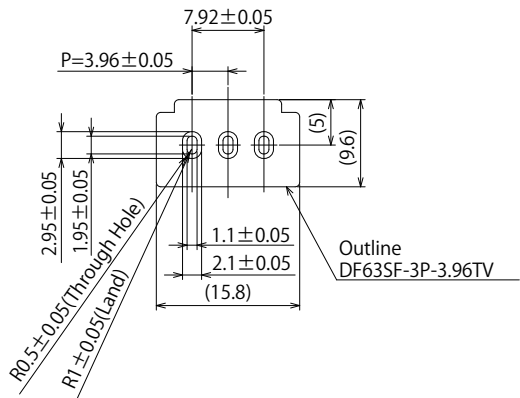

● Packaging Specification

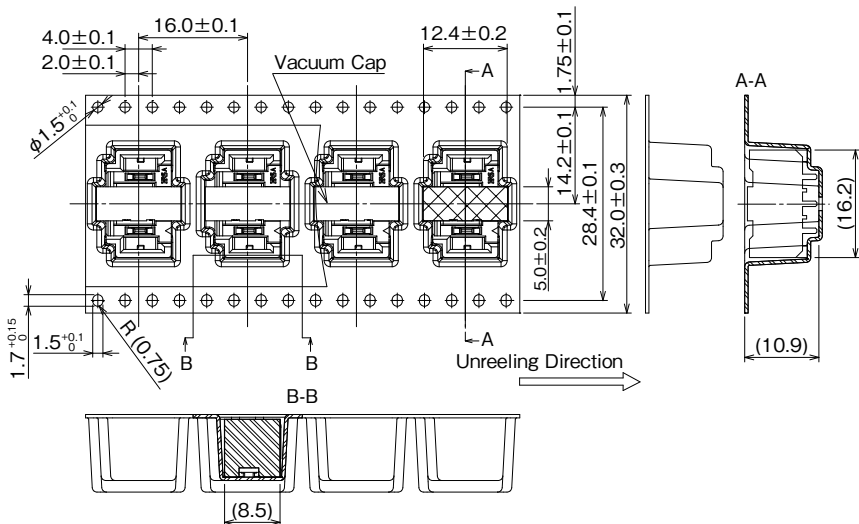

● Style of Reel

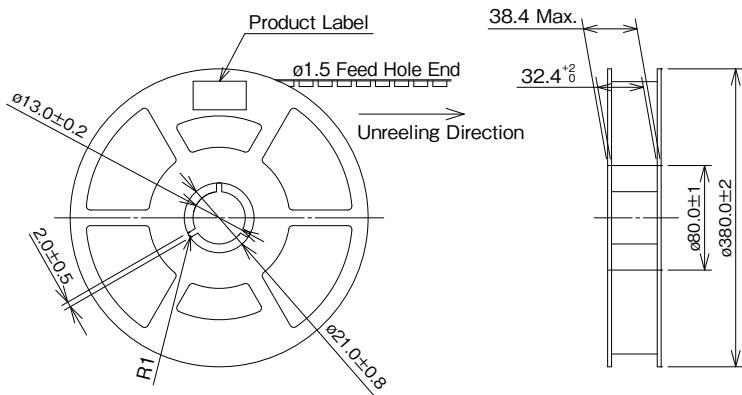

Jan. 1. 2023 Copyright 2023 HIROSE ELECTRIC CO., LTD. All Rights Reserved.

## Crimp Socket

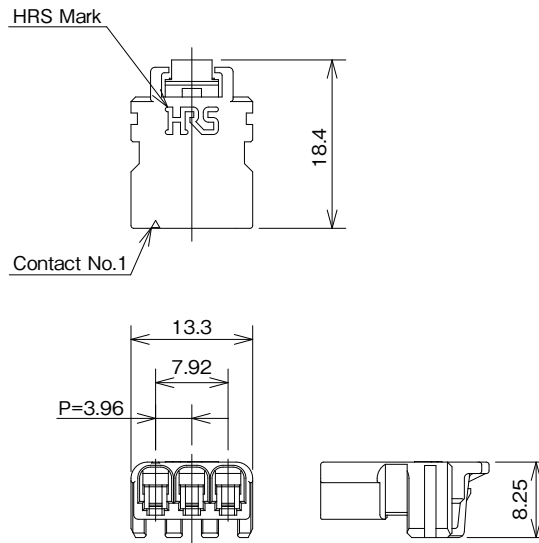

Part No.	HRS No.	No. of Pos.	Purchase Unit
DF63SF-3S-3.96C	CL0680-0702-0-00	3	100pcs per bag



## Crimp Contact

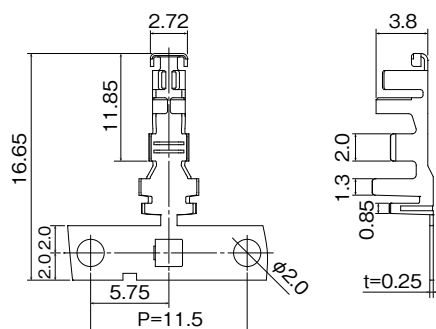

Part No.	HRS No.	Type	Purchase Unit	Finish
DF63SF-1618SCFA	CL0680-0703-0-00	Reel Contact	3,000pcs per reel	Gold Plated 0.2 $\mu$ m
DF63SF-1618SCA	CL0680-0706-0-00	Loose Contact	100pcs per bag	
DF63SF-1618SCFA(05)	CL0680-0703-0-05	Reel Contact	3,000pcs per reel	Gold Plated 0.76 $\mu$ m
DF63SF-1618SCA(05)	CL0680-0706-0-05	Loose Contact	100pcs per bag	

[Specification number] (##)

None : Gold Plated(0.2  $\mu$  m)

(05) : Gold Plated(0.76  $\mu$  m)

### ● Applicable Wire (Tinned Annealed Copper Wire)

Conductor Size (Core Structure)	Jacket Outer Diameter	Recommended Wire (Note 1)	Strip Length (Note 2)
16 AWG 26 pieces/0.254mm in diameter	$\phi$ 2.40mm	UL1007	3.1 to 3.8mm
16 AWG 54 pieces/0.180mm in diameter	$\phi$ 2.53mm	UL1430	
18 AWG 34 pieces/0.180mm in diameter	$\phi$ 2.10mm	UL1007	

Note 1 : Please contact a Hirose sales representative when using wires other than applicable wires.

Note 2 : The strip length is a reference value. Please adjust the strip length accordingly for specifications and requirements.

Refer to the Crimp Quality Standard (ATAD-H0891-00) for details.

## Mated Dimensions

### ● Wire-to-Board Connection Using the Straight Pin Header

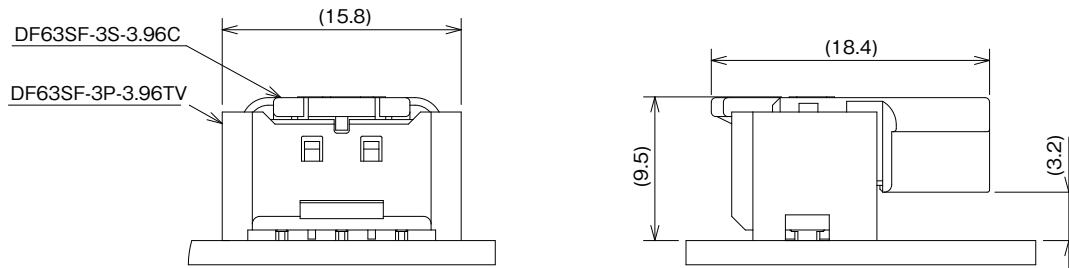

## Applicable Crimping Tool

Type	Part No.	HRS No.	Applicable Contact
Applicator	AP105-DF63SF-1618S	CL0901-4651-0-00	DF63SF-1618SCFA(##)
	CHX022400H-UP (Note 3)	-	
Press Body	CM-105C	CL0901-0001-0-00	-
Hand Tool	HT802/DF63SF-1618SA (Note 2)	CL0550-0440-0-00	DF63SF-1618SCA(##)
Contact Extraction Tool	DF-C-PO(B)	CL0550-0179-2-00	-

Note 1 : Any problems that occur from using tools other than those specified by Hirose, are not covered by warranty.

Note 2 : Hand tool dies cannot be switched. The compatible wire is limited to UL1007 (16 to 18 AWG).

Note 3 : Applicator manufactured by JAPAN AUTOMATIC MACHINE (J.A.M.). Please visit the J.A.M. homepage, if you have inquiries about the applicator or crimp defects. (URL : <http://www.jam-net.co.jp>)

## Removing Contacts

Contact extraction tool : DF-C-PO(B)

For Crimp contacts : DF63SF-1618SC(F)A(##)

### ● Procedure

- To remove the crimped contact once inserted, use DF-C-PO(B) or a pointed needle to pull the cable out while lifting the mold lance.
- Due to any previous repairs, the strength of the lance may be compromised.
- Hirose recommends the use of a new crimp housing to assure proper performance.

### Cross-Section Diagram of Housing

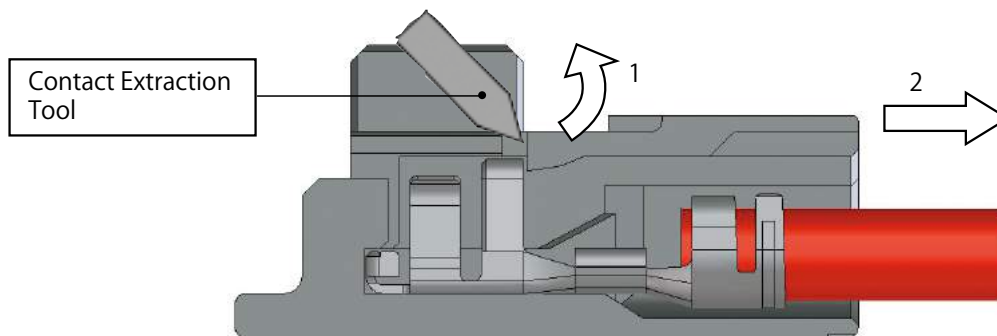

**⚠ Caution** Please be careful when removing the contact so that you don't become injured by the protruding part of the crimp contact.

## Precautions

### 1. Recommended Temperature Profile (Compatible With Lead-free Soldering)

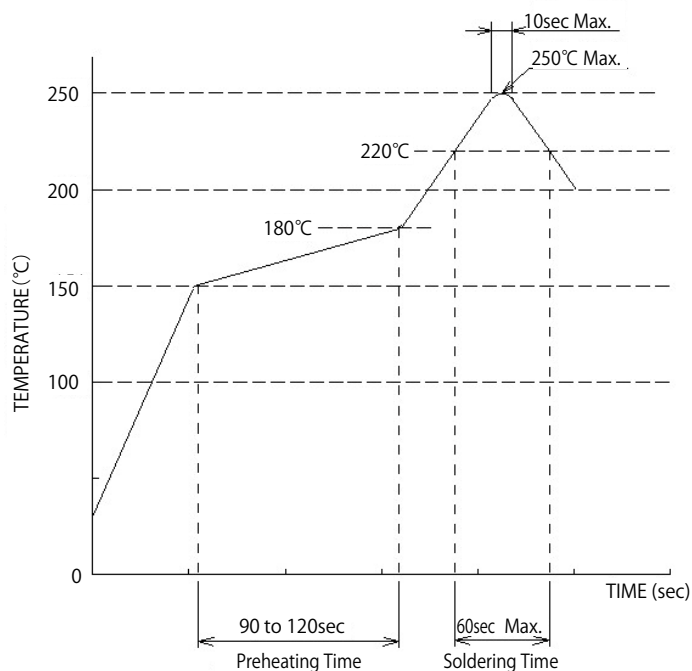

#### [Applicable Conditions]

1. Peak temperature : 250°C Max.
2. Heating area : 220°C Min. for less than 60 seconds
3. Preheating area : 150°C to 180°C for 90 to 120 seconds
4. Number of times : no more than 2 times

\* Measurement is conducted at the contact lead part. Soldering results may change depending on conditions such as solder paste type, manufacturer, PCB size, and other soldering materials. Please determine all mounting conditions before use.

Note 1 : This temperature profile is a recommended value.

Note 2 : Prohibited backside-surface mounting.

### 2. Recommended Manual Soldering Conditions

Temperature of soldering iron :  $350 \pm 10^\circ\text{C}$  , soldering time : within 5 seconds

### 3. Recommended screen thickness and board thickness

Screen thickness : 0.15mm  
Board thickness : 1.6mm

### 4. Board Warpage

A maximum of 0.02mm at the center of connector, as measured from either end of the connector

### 5. Cleaning Conditions

IPA cleaning is allowed. (Cleaning is not recommended due to potential changes in mating action and other variables. Please contact us if you use other cleaning agents.)

### 6. Notes

1. Please note that any mating operation of the connector when not mounted on the board may cause damage or deformation of the contacts.
2. Do not apply excessive amounts of flux during hand soldering as it may cause excess solder and flux wicking.
3. This housing color may have slight variations depending on the production lot. This color variation does not affect performance.
4. The connector could be damaged if it is pulled out forcibly. When it is hard to pull out, push it in slightly first and then depress the lock and un-mate.
5. When thick, short sections of wire are used, the connector could be deformed due to the force of the wires' position. Route cables in such a way that they do not twist when being installed.
6. Please do not touch any area around the contact part with your hand when the power is on; it could be very dangerous.
7. Please refer to "DF63SF Series Mating and Unmating Procedure Document (ETAD-H0901-00)" for points in handling regarding mating operations.
8. Please refer to "Harness Procedure Manual (ETAD-H0897-00)" for points in harness operations.

## Rated Values

Please avoid using the device above the rated values. Also, do not insert or pull out energized or "live" wires.

Note : "Live Wire Insertion" refers to inserting/removing cables while electricity is running.

## Operating Environment

Please contact us if you are designing this connector into environmental conditions where high and low temperatures are repeated.

## While taking in consideration

Specifications mentioned in this catalog are reference values.

When considering to order or use this product, please confirm the "Drawing" and "Product Specifications" sheets.

Use an appropriate cable when using the connector in combination with cables.

If considering usage of a non-specified cable, please contact your sales representative.

If assembly process is done by jigs & tools which are not identified by Hirose assurance will not be given.

Please consult with your Hirose sales representative if you are planning to use the product for any of the following applications. (Automotive, medical, public infrastructure, aerospace/defense, etc.)

Hirose will consider the validity of the warranty depending on the conditions.