

**CONNECTOR
 DESIGNATORS**
A-B*-C-D-E-F
G-H-J-K-L-S

* Conn. Desig. B See Note 6
DIRECT COUPLING

**TYPE A OVERALL
 SHIELD TERMINATION**

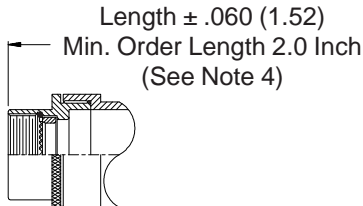
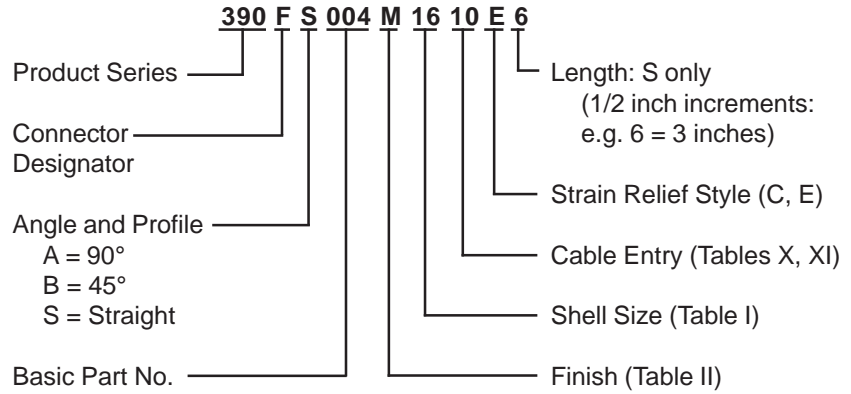

STYLE 2
(STRAIGHT)
 See Note 1)

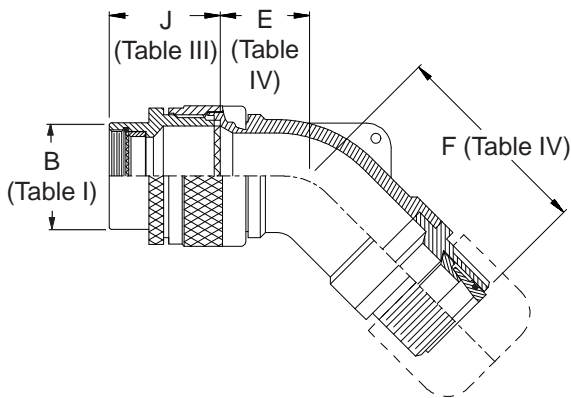
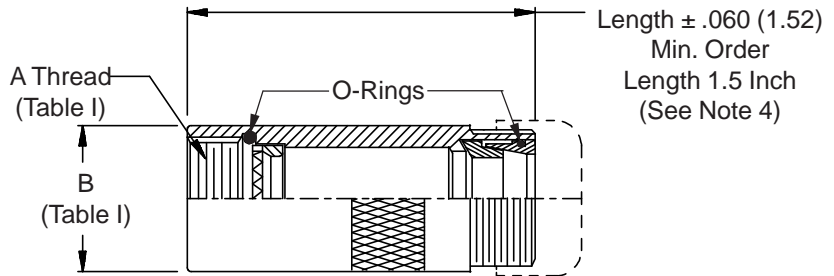

STYLE C
 Medium Duty
 (Table X)

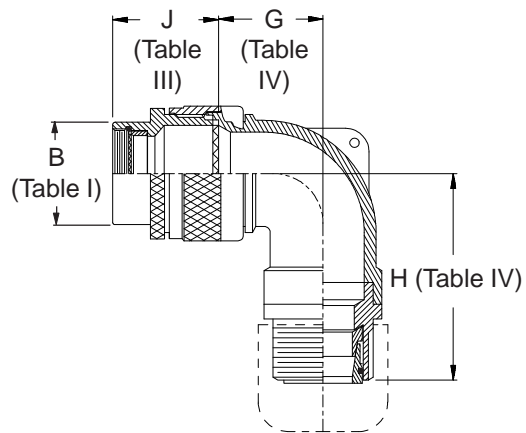

STYLE E
 Medium Duty
 (Table XI)

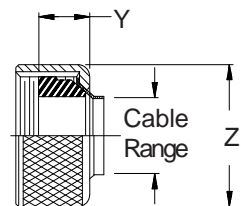
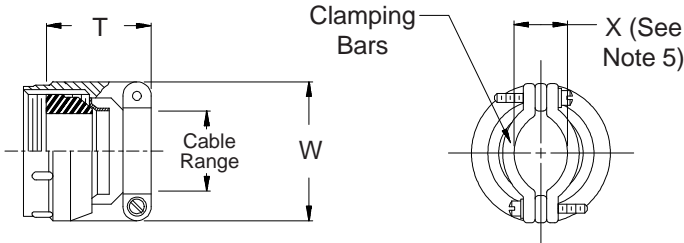

390-004
Water-Tight EMI/RFI Cable Sealing Backshell
with Strain Relief
Type A - Direct Coupling - Low Profile



See inside back cover fold-out or pages 13 and 14 for Tables I and II.

TABLE III: FRONT ADAPTER			
Shell Size	J Max - Conn. Designator		
	A-E-F	D-B-G-K	C
	J-H-L-S		
08/09	1.180 (30.0)	1.440 (36.6)	
10/11	1.180 (30.0)	1.440 (36.6)	
12/13	1.180 (30.0)	1.440 (36.6)	1.735 (44.1)
14/15	1.180 (30.0)	1.440 (36.6)	1.915 (48.6)
16/17	1.380 (35.0)	1.560 (39.6)	1.915 (48.6)
18/19	1.380 (35.0)	1.560 (39.6)	1.915 (48.6)
20/21	1.380 (35.0)	1.560 (39.6)	1.915 (48.6)
22/23	1.380 (35.0)	1.560 (39.6)	1.915 (48.6)
24/25	1.380 (35.0)	1.560 (39.6)	1.915 (48.6)
28/29	1.610 (40.9)	1.560 (39.6)	1.915 (48.6)
32/33	1.610 (40.9)	1.750 (44.5)	1.915 (48.6)
36	1.610 (40.9)	1.750 (44.5)	1.915 (48.6)
40	1.610 (40.9)	2.190 (55.6)	1.915 (48.6)

TABLE IV: ELBOW DIMENSIONS						
Dash No.	E Max	F Max	G Max	H Max		
04	.630 (16.0)	1.250 (31.8)	.636 (16.2)	1.200 (30.5)		
06	.630 (16.0)	1.250 (31.8)	.710 (18.0)	1.320 (33.5)		
08	.692 (17.6)	1.312 (33.3)	.731 (18.6)	1.340 (34.0)		
10	.755 (19.2)	1.655 (42.0)	.825 (21.0)	1.660 (42.2)		
12	.848 (21.5)	1.765 (44.8)	.988 (25.1)	1.750 (44.5)		
16	1.036 (26.3)	1.952 (49.6)	1.087 (27.6)	1.925 (48.9)		
20	1.130 (28.7)	2.098 (53.3)	1.325 (33.7)	2.033 (51.6)		
24	1.255 (31.9)	2.155 (54.7)	1.337 (34.0)	2.250 (57.2)		
28	1.317 (33.5)	2.250 (57.2)	1.827 (46.4)	2.450 (62.2)		
32	1.348 (34.2)	2.343 (59.5)	2.027 (51.5)	2.450 (62.2)		

TABLE X: CABLE ENTRY						
Dash No.	T Max	W Max	X Ref	Cable Range		
				Min	Max	
03	1.219 (31.0)	.812 (20.6)	.135 (3.4)	.156 (4.0)	.219 (5.6)	
04	1.219 (31.0)	.937 (23.8)	.203 (5.2)	.188 (4.8)	.312 (7.9)	
06	1.219 (31.0)	1.062 (27.0)	.285 (7.2)	.281 (7.1)	.438 (11.1)	
08	1.219 (31.0)	1.188 (30.2)	.350 (8.9)	.312 (7.9)	.531 (13.5)	
10	1.281 (32.5)	1.312 (33.3)	.390 (9.9)	.375 (9.5)	.625 (15.9)	
12	1.281 (32.5)	1.562 (39.7)	.460 (11.7)	.500 (12.7)	.750 (19.1)	
16	1.406 (35.7)	1.750 (44.5)	.510 (13.0)	.625 (15.9)	.938 (23.8)	
20	1.656 (42.1)	2.250 (57.2)	.695 (17.7)	.938 (23.8)	1.250 (31.8)	
24	1.906 (48.4)	2.375 (60.3)	.715 (18.2)	1.000 (25.4)	1.375 (34.9)	
28	1.906 (48.4)	2.625 (66.7)	.915 (23.2)	1.250 (31.8)	1.625 (41.3)	
32	2.000 (50.8)	2.812 (71.4)	1.070 (27.2)	1.500 (38.1)	1.875 (47.6)	

TABLE XI: CABLE ENTRY				
Dash No.	Y Max	Z Max	Cable Range	
			Min	Max
03	.739 (18.8)	.812 (20.6)	.156 (4.0)	.219 (5.6)
04	.739 (18.8)	.937 (23.8)	.188 (4.8)	.312 (7.9)
06	.739 (18.8)	1.062 (27.0)	.281 (7.1)	.438 (11.1)
08	.739 (18.8)	1.188 (30.2)	.312 (7.9)	.531 (13.5)
10	.791 (20.1)	1.312 (33.3)	.375 (9.5)	.625 (15.9)
12	.880 (22.4)	1.562 (39.7)	.500 (12.7)	.750 (19.1)
16	.901 (22.9)	1.750 (44.5)	.625 (15.9)	.938 (23.8)
20	1.031 (26.2)	2.250 (57.2)	.938 (23.8)	1.250 (31.8)
24	1.250 (31.8)	2.375 (60.3)	1.000 (25.4)	1.375 (34.9)
28	1.250 (31.8)	2.625 (66.7)	1.250 (31.8)	1.625 (41.3)
32	1.312 (33.3)	2.812 (71.4)	1.500 (38.1)	1.875 (47.6)

- When maximum cable entry (page 22) is exceeded, Style 2 will be supplied. (Function S only).
- Metric dimensions (mm) are indicated in parentheses.
- Cable range is defined as the accommodations range for the wire bundle or cable. Dimensions shown are not intended for inspection criteria.
- Consult factory for shorter lengths on straight backshells.
- Saddles are bottomed on Clamp Ears.
- When using Connector Designator B refer to pages 18 and 19 for part number development.

TABLE I - BACKSHELL INTERFACE DIMENSIONS

CONNECTOR DESIGNATOR											A THREAD*	B	C	D	E
A	C*	D	E	F	G	H	J	K	L	S	REFERENCE	DIA MAX	DIA MAX	DIA MAX	DIA MAX
		08	08	08 [9]				08	08	08	7/16 - 28 UNEF	.590 (15.)	.650 (16.5)	.770 (19.6)	.690 (17.5)
						09 [A]					M12 x 1 - 6H	.650 (16.5)	.770 (19.6)		.940 (24.8)
08							08 [A]	10			1/2 - 20 UNF	.650 (16.5)	.650 (16.5)		.690 (17.5)
											1/2 - 28 UNEF	.650 (16.5)	.770 (19.6)	.770 (19.6)	
03		10	10	10 [11]				11	10	10	9/16 - 24 UNEF	.720 (18.3)	.770 (19.6)	.890 (22.6)	.820 (20.8)
						11 [B]					M15 x 1 - 6H	.770 (19.6)	.820 (20.8)		1.060 (26.9)
10								12 [13]			5/8 - 24 UNEF	.770 (19.6)	.770 (19.6)	.890 (22.6)	.820 (20.8)
								10 [B]			5/8 - 28 UN	.770 (19.6)	.890 (22.6)		
		12		12 [13]					12	12	11/16 - 24 UNEF	.840 (21.3)	.890 (22.6)	1.020 (25.9)	.940 (23.8)
						13 [C]					M18 x 1 - 6H	.890 (22.6)	.940 (23.9)		1.170 (29.7)
12 [7]	12		12		11 [A]			14 [15]			3/4 - 20 UNEF	.970 (24.6)	.940 (23.9)	1.020 (25.9)	.940 (23.8)
		14	14	14 [15]					14	14	13/16 - 20 UNEF	.970 (24.6)	1.020 (29.2)	1.150 (29.2)	1.060 (26.9)
						15 [D]					M22 x 1 - 6H	1.030 (26.2)	1.070 (26.2)		1.290 (32.7)
14 [12]	14				13 [B]			16 [17]			7/8 - 20 UNEF	1.090 (27.7)	1.020 (25.9)	1.150 (29.2)	1.060 (26.9)
								14 [D]			7/8 - 28 UN	1.030 (26.2)	1.150 (29.2)		
		16	16	16 [17]					16	16	15/16 - 20 UNEF	1.090 (27.7)	1.150 (29.2)	1.260 (32.0)	1.170 (29.7)
						17 [E]					M25 x 1 - 6H	1.150 (29.2)	1.210 (30.7)		1.420 (36.1)
16 [19]	16				15 [C]			18			1 - 20 UNEF	1.220 (29.2)	1.210 (30.7)	1.230 (31.2)	1.170 (29.7)
								16 [E]			1 - 28 UN	1.150 (29.2)	1.360 (34.5)		
18 [27]		18	18	18 [19]					18	18	1 1/16 - 18 UNEF	1.220 (31.0)	1.230 (31.2)	1.400 (35.6)	1.290 (32.7)
						19 [F]					M28 x 1 - 6H	1.280 (32.5)	1.360 (34.5)		1.540 (39.1)
	18				17 [D]			20			1 1/8 - 18 UNEF	1.340 (34.0)	1.360 (34.5)	1.360 (34.5)	
								18 [F]			1 1/8 - 28 UN	1.280 (32.5)	1.480 (37.6)		
20 [37]		20	20	20 [21]					20	20	1 3/16 - 18 UNEF	1.340 (34.0)	1.360 (34.5)	1.530 (38.9)	1.420 (36.0)
						21 [G]					M31 x 1 - 6H	1.410 (35.8)	1.480 (37.6)		1.670 (42.4)
	20				19 [E]			22			1 1/4 - 18 UNEF	1.470 (37.3)	1.530 (38.9)	1.480 (37.6)	
								20 [G]			1 1/4 - 28 UN	1.410 (35.8)	1.600 (40.6)		
22		22	22	22 [23]					22	22	1 5/16 - 18 UNEF	1.470 (37.3)	1.480 (37.6)	1.600 (40.6)	1.540 (39.1)
						23 [H]					M34 x 1 - 6H	1.530 (38.9)	1.600 (40.6)		2.010 (51.1)
	22							24			1 3/8 - 18 UNEF	1.590 (40.4)		1.600 (40.6)	
								22 [H]			1 3/8 - 28 UN	1.530 (38.9)	1.730 (43.9)		
24		24	24	24 [25]	23 [F]				24	24	1 7/16 - 18 UNEF	1.590 (40.4)	1.730 (43.9)	1.940 (49.3)	1.660 (42.2)
						25 [J]					M37 x 1 - 6H	1.660 (42.2)	1.700 (43.2)		2.120 (53.8)
61								24 [J]			1 1/2 - 18 UNEF	1.660 (42.2)	1.670 (42.4)		
											1 1/2 - 28 UN	1.660 (42.2)	1.940 (49.3)		
					25 [G]						1 9/16 - UNEF		1.820 (46.2)		
	24							28			1 5/8 - UNEF	1.840 (46.7)		1.940 (49.3)	
28											1 3/4 - 18 UNS	1.970 (50.0)	1.970 (50.0)		2.010 (51.1)
	28				29 [H]			32			1 7/8 - 16 UN	2.090 (53.1)	2.190 (55.6)	2.190 (55.6)	
32											2 - 18 UNS	2.280 (57.9)	2.220 (56.4)		2.260 (57.4)
	32				33 [J]						2 1/16 - 16 UNS	2.340 (59.4)	2.440 (62.0)	2.440 (62.0)	
								36			2 1/8 - 16 UN	2.340 (59.4)		2.440 (62.0)	
36											2 1/4 - 16 UN	2.530 (64.3)	2.47 (62.7)		2.530 (64.3)
	36										2 5/16 - 16 UNS	2.590 (65.8)		2.690 (68.3)	
								40			2 3/8 - 16 UN	2.590 (65.8)		2.690 (68.3)	
40											2 1/2 - 16 UN	2.780 (70.6)	2.720 (69.1)		3.040 (77.2)
	40										2 5/8 - 16 UN	2.910 (73.9)		2.930 (74.4)	
44											2 3/4 - 16 UN	3.030 (77.0)	2.970 (75.4)		
	44										2 7/8 - 16 UN	3.160 (80.3)			
48											3 - 16 UN	3.220 (81.8)	3.220 (81.8)		
	48										3 1/16 - 16 UN	3.410 (86.6)			

* Code C, MIL-C-22992, Left-Hand Thread. Connector designations depicted thus [] are for reference only and are not to be used in part number development.

BACKSHELL INTERFACE STANDARDS (See pages 15-17 for more information)

DESIG. SPEC.	SERIES	DESIG. SPEC.	SERIES	DESIG. SPEC.	SERIES	DESIG. SPEC.	SERIES
A	MIL-DTL-5015 MS3400	A	PATT 602	G	MIL-C-28840	L	EN3372
	MIL-DTL-26482 2	B	MIL-DTL-5015 MS3100	H	MIL-DTL-38999 III & IV		JN 1003
	AS81703 3	C	MIL-C-22992 MS173XX		EN3645		LN 29729
	MIL-DTL-83723 I & III	D	MIL-DTL-26482 1	J	MIL-C-81511 1, 2, 3 & 4		NFC93422
	40M39569	E	MIL-DTL-26500 Aluminum	K	VG95329		PAN 6433-2
	DEF 5326-3	F	MIL-DTL-38999 I & II				PATT 615
	EN 2997, 3646		40M38277				VG 96912
	ESC 10, 11		PAN 6433-1			S	PATT 105
	LN 29504		PATT 614				PATT 603
	NFC93422 HE302		PATT 616				PATT 608
	PAN 6432-1, -2		NFC93422 HE308, 9				



Reference Information Standard Materials and Finishes

TABLE II - STANDARD FINISHES

GLENAIR SYMBOL	M85049 SYMBOL REFERENCE ONLY	FINISH	SPECIFICATION(S)
A		Cadmium Plate, Bright	AMS-QQ-P-416, Type I, Class 2
B		Cadmium Plate, Olive Drab	AMS-QQ-P-416, Type II, Class 3
C*	A	Anodize, Black	AMS-A-8625, Type II, Class 2
G*		Hard Coat, Anodic	AMS-A-8625, Type III, Class 1
J		Iridite, Gold Over Cadmium Plate Over Electroless Nickel	MIL-C-5541, Class 3 AMS-QQ-P-416, Type II, Class 3 over AMS-C-26074, Class 4, Grade B
LF		Cadmium Plate, Bright Over Electroless Nickel	1000 Hour Corrosion Resistance
M	N	Electroless Nickel	AMS-C-26074, Class 4, Grade B
N		Cadmium Plate, Olive Drab Over Electroless Nickel	AMS-QQ-P-416, Type II, Class 3 over Electroless Nickel AMS-C-26074
NC		Zinc Cobalt, Dark Olive Drab	96 Hour Corrosion Resistance
NF	W	Cadmium Plate, Olive Drab Over Electroless Nickel	1000 Hour Corrosion Resistance
T		Cadmium Plate, Bright Over Electroless Nickel	AMS-QQ-P-416, Type I, Class 3 ASTMB 733-90, SC2, Type I, Class 5, MIL-C-26074***
U		Cadmium Plate, Black	AMS-QQ-P-416, Type II, Class 3
ZU**		Cadmium Plate, Black	AMS-QQ-P-416, Type II, Class 3
ZN		Zinc-Nickel Alloy, Olive Drab	ASTMB 841-91, Over Electroless Nickel 1000 Hour Salt Spray

* Anodize finish; not suitable for EMI Shielding or grounding applications.
 ** Applicable to corrosion resisting steel backshells and accessories. Consult factory for other available finishes.

The following standard materials are used for the majority of Glenair backshells and connector accessories. However, backshell components are not limited to those items listed, but are representative of the elements used in Glenair's general accessory products. Contact Glenair for applicable specifications on items not listed below.

STANDARD MATERIALS - BACKSHELLS AND ACCESSORIES

COMPONENT	MATERIAL	SPECIFICATION
Machined components: such as backshell bodies, fabricated elbows, protective covers, rotatable couplers, dummy stowage receptacles, lock nuts, G-spring support rings, EMI ground rings, grommet followers, etc.	Aluminum	AMS-QQ-A-200 ASTMB221, 209
Die cast components: such as angular backshells, strain relief backshells, strain relief bodies, strain relief saddles, special EMI ground rings, etc.	Aluminum	QQ-A-591 ASTMB85, 26
Backshells or strain reliefs: available in optional corrosion resisting steel; and hardware: such as screws, washers, rivets, wire rope, sash chain, band straps, etc.	Corrosion Resisting Steel	ASTMA582 (300 Series) AMS-QQ-S-763
Elastomeric seals: such as O-rings, cable jacket seals, grommets, etc.	Silicone	ZZ-R-765, MIL-R-25988
Anti-friction and thrust washers	Teflon	TFE
Anti-rotation device	Corrosion Resistant Material	N/A

BODY STRAP

Glenair offers an optional stainless steel body strap for attaching protective covers as illustrated. To specify body strap, add suffix letter C to the end of the part number. For example 360AS001M1610M6C.

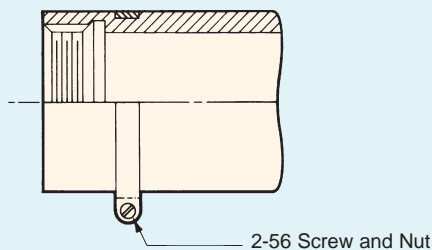

NOTES

On all length callouts, tolerance is $\pm .060$ unless otherwise specified.

Unless otherwise specified, the following other dimensional tolerances will apply:

- .xx = $\pm .03$ (0.8)
- .xxx = $\pm .015$ (0.4)
- Lengths = $\pm .060$ (1.52)
- Angles = $\pm 5^\circ$

Metric dimensions (mm) are indicated in parentheses

NOTE: For your convenience these tables have been reproduced inside the back cover fold-out.

Glenair Backshell and Accessory Material and Finish Options

Backshell and accessory base materials, plating options, specifications and codes

Code	Material	Finish	Finish Specification	Hrs. Salt Spray	Electrical Conductivity	Operating Temp. Range	RoHS	Notes
A	Aluminum	Cadmium, No Chromate	SAE-AMS-QQ-P-416 Type I Class 3	48	Conductive	-65 to +175°C		Not recommended for new projects. LF is preferred.
AB	Marine Bronze	Unplated		1000	Conductive	-65 to +200°C	✓	Marine and geophysical applications.
AL	Aluminum	AlumiPlate, Clear Chromate	MIL-DTL-83488, Class 2, Type II over electroless nickel	1000	Conductive	-65 to +175°C	✓	Approved for MIL-DTL-38999L and MIL-DTL-83513G.
B	Aluminum	Cadmium, Olive Drab	SAE-AMS-QQ-P-416 Type II Class 3	96	Conductive	-65 to +175°C		Not recommended for new projects. NF is preferred.
C	Aluminum	Anodize, Black	AMS-A-8625 Type II Class 2	336	Non-Conductive	-65 to +175°C	✓	Glenair's standard black anodize finish.
E	Aluminum	Chem Film	MIL-DTL-5541 Type 1 Class 3	168	Conductive	-65 to +175°C		Glenair's standard chem film finish.
G	Aluminum	Anodize, Hardcoat	AMS-A-8625 Type III, Class 1, .001" thick	336	Non-Conductive	-65 to +200°C	✓	Glenair's preferred hardcoat finish.
J	Aluminum	Cadmium, Gold	SAE-AMS-QQ-P-416 Type II, Class 2 over electroless nickel	500	Conductive	-65 to +175°C		Not recommended for new projects. JF is preferred.
JF	Aluminum	Cadmium, Gold	SAE-AMS-QQ-P-416 Type II, Class 2 over electroless nickel	1000	Conductive	-65 to +175°C		Glenair's preferred gold cadmium finish.
LF	Aluminum	Cadmium, Clear	SAE-AMS-QQ-P-416 Type II Class 2 over electroless nickel	1000	Conductive	-65 to +175°C		Glenair's preferred clear cadmium finish.
M	Aluminum	Electroless Nickel	AMS-C-26074 Class 4 Grade B; ASTM-B-733, SC 2, Type IV	48	Conductive	-65 to +200°C	✓	Glenair's standard electroless nickel finish.
MT	Aluminum	Nickel-PTFE	GMF-002 Type II Class 1	1000	Conductive	-65 to +175°C	✓	Approved for MIL-DTL-38999L and MIL-DTL-83513G.
N	Aluminum	Cadmium, Olive Drab	SAE-AMS-QQ-P-416 Type II Class 3 over electroless nickel	500	Conductive	-65 to +175°C		Not recommended for new projects. NF is preferred.
NC	Aluminum	Zinc-Cobalt, Olive Drab	ASTM B 840 Grade 6 Type D over electroless nickel	350	Conductive	-65 to +175°C		Glenair's standard olive drab zinc-cobalt finish.
NF	Aluminum	Cadmium, Olive Drab	SAE-AMS-QQ-P-416 Type II Class 2 over electroless nickel	1000	Conductive	-65 to +175°C		Glenair's standard olive drab cadmium finish.
P	Stainless Steel	Electrodeposited Nickel	SAE-AMS-QQ-N-290 Class 1 Grade F	500	Conductive	-65 to +200°C	✓	Use ZM for electroless nickel alternative.
T	Aluminum	Cadmium, No Chromate	SAE-AMS-QQ-P-416 Type I Class 3	48	Conductive	-65 to +175°C		Not recommended for new projects. LF is preferred.
TP2	Titanium	Electrodeposited Nickel	SAE-AMS-QQ-N-290 Class 1 Grade F	96	Conductive	-65 to +200°C	✓	Glenair's preferred finish for titanium connectors.
U	Aluminum	Cadmium, Black	SAE-AMS-QQ-P-416 Type I Class 3	48	Conductive	-65 to +175°C		Not recommended for new projects. UF is preferred.
UC	Aluminum	Zinc-Cobalt, Black	ASTM B 840 Grade 6 Type D over electroless nickel	350	Conductive	-65 to +175°C		Glenair's standard black zinc-cobalt finish.
UCR	Aluminum	Zinc-Cobalt, Black	ASTM B 840 Grade 6 Type D over electroless nickel	350	Conductive	-65 to +175°C	✓	RoHS version of UC.
UF	Aluminum	Cadmium, Black	SAE-AMS-QQ-P-416 Type II Class 2 over electroless nickel	1000	Conductive	-65 to +175°C		Glenair's preferred black cadmium finish.
XAL	Composite	AlumiPlate	MIL-DTL-86448, Class 2, Type II over electroless nickel	2000	Conductive	-65 to +175°C	✓	Approved for MIL-DTL-38999L.
XB	Composite	Unplated Black		2000	Non-Conductive	-65 to +175°C	✓	Glenair's standard unplated composite.
XM	Composite	Electroless Nickel	AMS-C-26074	2000	Conductive	-65 to +175°C	✓	Glenair's standard electroless nickel finish over composite.
XMT	Composite	Nickel-PTFE	GMS-002 Class 2 Type II	2000	Conductive	-65 to +175°C	✓	Approved for MIL-DTL-38999L.
XO	Composite	Unplated Light Brown		2000	Non-Conductive	-65 to +175°C	✓	Not recommended for new projects. Use XB.
XW	Composite	Cadmium, Olive Drab	SAE-AMS-QQ-P-416 Type II Class 3 over electroless nickel	2000	Conductive	-65 to +175°C		Glenair's standard olive drab cadmium finish over composite.
XZN	Composite	Zinc-Nickel, Black	ASTM B841 Grade 5 over electroless nickel	2000	Conductive	-65 to +175°C		Glenair's standard black zinc-nickel finish over composite.
Z1	Stainless Steel	Passivate	SAE-AMS-SAE-AMS-QQ-P-35 Type VI	1000	Conductive	-65 to +200°C	✓	Glenair's standard passivated stainless steel.
Z2	Aluminum	Gold	MIL-DTL-45204 Class 1 over electroless nickel	48	Conductive	-65 to +200°C	✓	Glenair's standard gold plating for space programs.
ZC	Stainless Steel	Zinc-Cobalt, Black	ASTM-B840, Grade 6		Conductive	-65 to +175°C		Glenair's standard zinc-cobalt over stainless steel.
ZCR	Stainless Steel	Zinc-Cobalt, Black	ASTM-B840, Grade 6		Conductive	-65 to +175°C	✓	RoHS version of ZC.
ZL	Stainless Steel	Electrodeposited Nickel	SAE-AMS-QQ-N-290 Class 1 Grade F	1000	Conductive	-65 to +200°C	✓	Used on hermetic connectors. Use ZM for other applications.
ZM	Stainless Steel	Electroless Nickel	AMS-C-26074 Class 1 Grade A		Conductive	-65 to +200°C	✓	Glenair's preferred nickel-plated stainless steel.
ZMT	Stainless Steel	Nickel-PTFE	GMF-002 Type II Class 3	1000	Conductive	-65 to +175°C	✓	Glenair's new 1000 Hour Grey over stainless steel.
ZN	Aluminum	Zinc-Nickel, Olive Drab	ASTM B841 Grade 5 over electroless nickel	1000	Conductive	-65 to +175°C		Glenair's standard olive drab zinc-nickel finish.
ZNU	Aluminum	Zinc-Nickel, Black	ASTM B841 Grade 5 over electroless nickel	1000	Conductive	-65 to +175°C		Glenair's standard black zinc-nickel finish.
ZR	Aluminum	Zinc-Nickel, Black	ASTM B841 Grade 5 over electroless nickel	500	Conductive	-65 to +175°C	✓	Glenair's RoHS compliant black zinc-nickel.
ZU	Stainless Steel	Cadmium, Black	SAE-AMS-QQ-P-416 Type II Class 3	1000	Conductive	-65 to +175°C		Glenair's standard black cadmium over stainless steel.
ZW	Stainless Steel	Cadmium, Olive Drab	SAE-AMS-QQ-P-416 Type II Class 2 over electroless nickel	2000	Conductive	-65 to +175°C		Glenair's standard olive drab cadmium over stainless steel.