



LINEAGE POWER®

KNW013/020-88 (Sixteenth-Brick) Power Modules; DC-DC Converters

36 –75V_{dc} Input; 3.3 to 5.0V_{dc} Output; 13A to 20A Output Current

RoHS Compliant



Applications

- Distributed power architectures
- Wireless networks
- Access and optical networking equipment including Power over Ethernet (PoE)
- Enterprise networks
- Latest generation IC's (DSP, FPGA, ASIC) and Microprocessor powered applications

Options

- Negative Remote On/Off logic
- Surface Mount (Tape and Reel, -SR Suffix)
- Over current /Over voltage protections (auto-restart)
- Shorter lead trim

Description

The KNW013/020-88 (Sixteenth-brick) series power modules are isolated dc-dc converters that operate over a wide input voltage range of 36 to 75Vdc and provide a single precisely regulated output. The output is fully isolated from the input, allowing versatile polarity configurations and grounding connections. The modules exhibit high efficiency, typical efficiency of 91% for 3.3V/20A. These open frame modules are available either in surface-mount (-SR) or in through-hole (TH) form.

Features

- Compliant to RoHS EU Directive 2002/95/EC (-Z versions)
- Compliant to RoHS EU Directive 2002/95/EC with lead solder exemption (non-Z versions)
- Delivers up to 20A output current
5V(13A), 3.3V(20A)
- High efficiency – 91% at 3.3V full load
- Small size and low profile:
33.0 mm x 22.9 mm x 10.2 mm
(1.30 in x 0.9 in x 0.40 in)
- Industry standard DOSA footprint
- -20% to +10% output voltage adjustment trim
- Remote on/off
- Remote sense
- No reverse current during output shutdown
- Over temperature protection (auto-restart)
- Output overcurrent/overvoltage protection (latching)
- Wide operating temperature range (-40°C to 85°C)
- 2250 Vdc Isolation tested in compliance with IEEE 802.3^m PoE standards
- Meets the voltage isolation requirements for ETSI 300-132-2 and complies with and is licensed for Basic Insulation rating per EN60950-1
- UL*Recognized to UL60950-1, CAN/CSA[†] C22.2 No.60950-1, and EN60950-1(VDE[‡] 0805-1) Licensed
- CE mark meets 2006/95/EC directive[§]
- ISO** 9001 and ISO 14001 certified manufacturing facilities

□ IEEE and 802 are registered trademarks of the Institute of Electrical and Electronics Engineers, Incorporated.

* UL is a registered trademark of Underwriters Laboratories, Inc.

† CSA is a registered trademark of Canadian Standards Association.

‡ VDE is a trademark of Verband Deutscher Elektrotechniker e.V.

§ This product is intended for integration into end-use equipment. All of the required procedures of end-use equipment should be followed.

** ISO is a registered trademark of the International Organization of Standards

Absolute Maximum Ratings

Stresses in excess of the absolute maximum ratings can cause permanent damage to the device. These are absolute stress ratings only, functional operation of the device is not implied at these or any other conditions in excess of those given in the operations sections of the data sheet. Exposure to absolute maximum ratings for extended periods can adversely affect the device reliability.

Parameter	Device	Symbol	Min	Max	Unit
Operating Input Voltage					
Continuous	All	V _{IN}	-0.3	80	Vdc
Transient (100 ms)	All	V _{IN,trans}	-0.3	100	Vdc
Operating Ambient Temperature (see Thermal Considerations section)	All	T _A	-40	85	°C
Storage Temperature	All	T _{stg}	-55	125	°C
I/O Isolation voltage (100% Factory Hi-Pot tested)	All	—	—	2250	Vdc

Electrical Specifications

Unless otherwise indicated, specifications apply over all operating input voltage, resistive load, and temperature conditions.

Parameter	Device	Symbol	Min	Typ	Max	Unit
Operating Input Voltage	All	V _{IN}	36	48	75	V _{dc}
Maximum Input Current (V _{IN} = V _{IN,min} to V _{IN,max} ; I _O = I _{O,max})	All	I _{IN,max}		1.7	2.4	A _{dc}
Input No Load Current (V _{IN} = V _{IN,nom} ; I _O = 0; module enabled)	All	I _{IN,No load}		45		mA
Input Stand-by Current (V _{IN} = V _{IN,nom} ; module disabled)	All	I _{IN,stand-by}		6	8	mA
Inrush Transient	All	I ² t			0.1	A ² s
Input Reflected Ripple Current, peak-to-peak (5Hz to 20MHz; 1μH source impedance; V _{IN,min} to V _{IN,max} ; I _O = I _{O,max} ; See Test configuration section)	All			30		mA _{p-p}
Input Ripple Rejection (120Hz)	All			60		dB
EMC, EN55022			See EMC Considerations section			

CAUTION: This power module is not internally fused. An input line fuse must always be used.

This power module can be used in a wide variety of applications, ranging from simple standalone operation to an integrated part of sophisticated power architectures. To preserve maximum flexibility, internal fusing is not included, however, to achieve maximum safety and system protection, always use an input line fuse. The safety agencies require a time-delay fuse with a maximum rating of 5 A (see Safety Considerations section). Based on the information provided in this data sheet on inrush energy and maximum dc input current, the same type of fuse with a lower rating can be used. Refer to the fuse manufacturer's data sheet for further information.

Electrical Specifications (continued)

Parameter	Device	Symbol	Min	Typ	Max	Unit
Output Voltage Set-point ($V_{IN}=V_{IN, min}$, $I_O=I_{O, max}$, $T_A=25^\circ\text{C}$)	5.0V 3.3V	$V_{O, set}$ $V_{O, set}$	4.93 3.25	5.0 3.3	5.07 3.35	V _{dc} V _{dc}
Output Voltage (Over all operating input voltage, resistive load, and temperature conditions until end of life)	All	V_O	-3.0		+3.0	% $V_{O, set}$
Adjustment Range Selected by an external resistor	All	$V_{O, adj}$	-20.0		+10.0	% $V_{O, set}$
Output Regulation Line ($V_{IN}=V_{IN, min}$ to $V_{IN, max}$) Load ($I_O=I_{O, min}$ to $I_{O, max}$) Temperature ($T_{ref}=T_{A, min}$ to $T_{A, max}$)	All All All		— — —	— — —	0.1 0.1 1.0	% $V_{O, set}$ % $V_{O, set}$ % $V_{O, set}$
Output Ripple and Noise on nominal output ($V_{IN}=V_{IN, nom}$, $I_O=I_{O, max}$, $T_A=T_{A, min}$ to $T_{A, max}$) RMS (5Hz to 20MHz bandwidth) Peak-to-Peak (5Hz to 20MHz bandwidth)	All		— —	25 75	30 100	mV _{rms} mV _{pk-pk}
External Capacitance	5.0V 3.3V	$C_{O, max}$ $C_{O, max}$	0	—	10,000 20,000	μF μF
Rated Output Current	5.0V 3.3V	$I_{O, Rated}$ $I_{O, Rated}$	0 0	— —	13 20	A _{dc} A _{dc}
Output Current Limit Inception (Hiccup Mode) ($V_O=90\%$ of $V_{O, set}$)	All	$I_{O, lim}$	115	120	130	% $I_{O, Rated}$
Output Short-Circuit Current ($V_O\leq 250\text{mV}$) (Hiccup Mode)	All	$I_{O, s/c}$	—	20	—	% $I_{O, max}$ Arms
Efficiency $V_{IN}=V_{IN, nom}$; $T_A=25^\circ\text{C}$; $I_O=I_{O, max}$; $V_O=V_{O, set}$	5.0V 3.3V	η η		91.0 91.0		% %
Switching Frequency	All	f_{sw}	—	400	—	kHz
Dynamic Load Response ($dI_O/dt=0.1\text{A}/\mu\text{s}$; $V_{IN}=V_{IN, nom}$; $T_A=25^\circ\text{C}$) Load Change from $I_O=50\%$ to 75% or 25% to 50% of $I_{O, max}$; Peak Deviation Settling Time ($V_O<10\%$ peak deviation)	All All	V_{pk} t_s	— —	4 200	— —	% $V_{O, set}$ μs
($dI_O/dt=1.0\text{A}/\mu\text{s}$; $V_{IN}=V_{IN, nom}$; $T_A=25^\circ\text{C}$) Load Change from $I_O=50\%$ to 75% or 25% to 50% of $I_{O, max}$; Peak Deviation Settling Time ($V_O<10\%$ peak deviation)	All All	V_{pk} t_s	— —	5 200	— —	% $V_{O, set}$ μs

Isolation Specifications

Parameter	Device	Symbol	Min	Typ	Max	Unit
Isolation Capacitance	All	C_{iso}	—	1000	—	pF
Isolation Resistance	All	R_{iso}	10	—	—	MΩ
I/O Isolation Voltage	All	All	—	—	2250	V _{dc}

General Specifications

Parameter	Device	Symbol	Min	Typ	Max	Unit
Calculated Reliability Based upon Telcordia SR-332 Issue 2: Method I, Case 3, ($I_O=80\%I_{O,max}$, $T_A=40^\circ\text{C}$, Airflow = 200 lfm), 90% confidence	5.0V	MTBF		4,114,000		Hours
	5.0V	FIT		243.1		10 ⁹ /Hours
	3.3V	MTBF		4,589,027		Hours
	3.3V	FIT		217.9		10 ⁹ /Hours
Powered Random Vibration ($V_{IN}=V_{IN,min}$, $I_O=I_{O,max}$, $T_A=25^\circ\text{C}$, 0 to 5000Hz, 10Grms)	All			90		Minutes
Weight	All		—	15.6 (0.55)	—	g (oz.)

Feature Specifications

Unless otherwise indicated, specifications apply over all operating input voltage, resistive load, and temperature conditions. See Feature Descriptions for additional information.

Parameter	Device	Symbol	Min	Typ	Max	Unit
Remote On/Off Signal Interface ($V_{IN}=V_{IN,min}$ to $V_{IN,max}$; open collector or equivalent, signal referenced to V_{IN} terminal) Negative Logic: device code suffix "1" Logic Low = module On, Logic High = module Off Positive Logic: No device code suffix required Logic Low = module Off, Logic High = module On Logic Low - Remote On/Off Current Logic Low - On/Off Voltage Logic High Voltage – (Typ = Open Collector) Logic High maximum allowable leakage current	All	$I_{on/off}$	—	—	1.0	mA
	All	$V_{on/off}$	-0.7	—	1.2	V
	All	$V_{on/off}$	—	—	5	V
	All	$I_{on/off}$	—	—	10	μA
Turn-On Delay and Rise Times ($I_O=I_{O,max}$, $V_{IN}=V_{IN,nom}$, $T_A=25^\circ\text{C}$) Case 1: On/Off input is set to Logic Low (Module ON) and then input power is applied (delay from instant at which $V_{IN}=V_{IN,min}$ until $V_O=10\%$ of $V_{O,set}$) Case 2: Input power is applied for at least 1 second and then the On/Off input is set from OFF to ON (T_{delay} = from instant at which $V_{IN}=V_{IN,min}$ until $V_O=10\%$ of $V_{O,set}$) Output voltage Rise time (time for V_O to rise from 10% of $V_{O,set}$ to 90% of $V_{O,set}$)	All	T_{delay}	—	13	20	msec
	All	T_{delay}	—	30	35	msec
	5.0	T_{rise}	—	20	25	msec
	3.3	T_{rise}	—	6	10	msec
Output voltage overshoot – Startup $I_O=I_{O,max}$; $V_{IN}=V_{IN,min}$ to $V_{IN,max}$; $T_A=25^\circ\text{C}$				—	3	% $V_{O,set}$
Remote Sense Range	All				+10	% $V_{O,set}$
Output Overvoltage Protection	5.0V	$V_{O,limit}$	6.1	—	7.0	V_{dc}
	3.3V	$V_{O,limit}$	4.0	—	4.6	V_{dc}
Input Undervoltage Lockout						
Turn-on Threshold	All	$V_{uv/on}$	32.5	34.0	35.8	V_{dc}
Turn-off Threshold	All	$V_{uv/off}$	30.0	31.0	33.0	V_{dc}
Hysteresis	All	V_{hyst}	2	—	—	V_{dc}

Characteristic Curves

The following figures provide typical characteristics for the KNW013A0Axx-88 (5V, 13A) at 25°C. The figures are identical for either positive or negative remote On/Off logic.

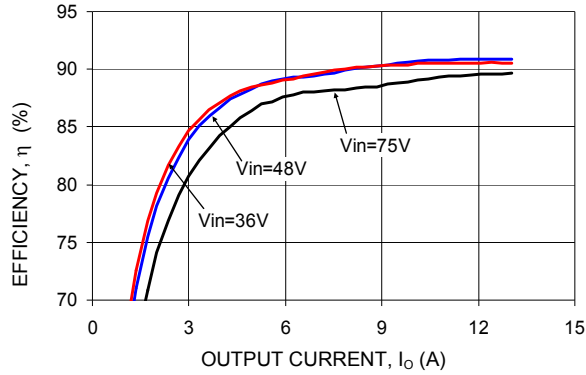

Figure 1. Converter Efficiency versus Output Current.

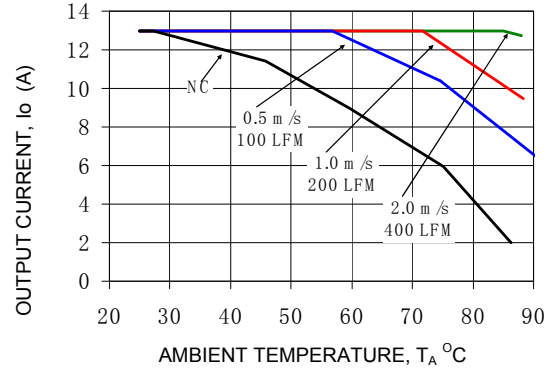

Figure 4. Derating Output Current versus Local Ambient Temperature and Airflow.

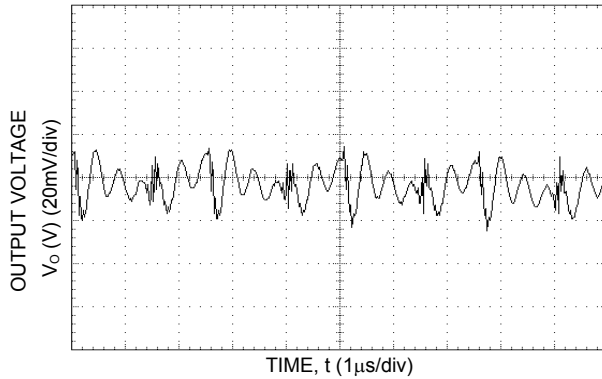

Figure 2. Typical output ripple and noise ($V_{IN} = V_{IN,NOM}$, $I_o = I_{o,max}$).

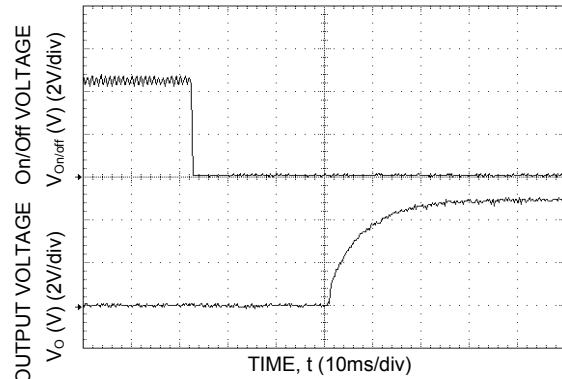

Figure 5. Typical Start-up Using Remote On/Off, negative logic version shown ($V_{IN} = V_{IN,NOM}$, $I_o = I_{o,max}$).

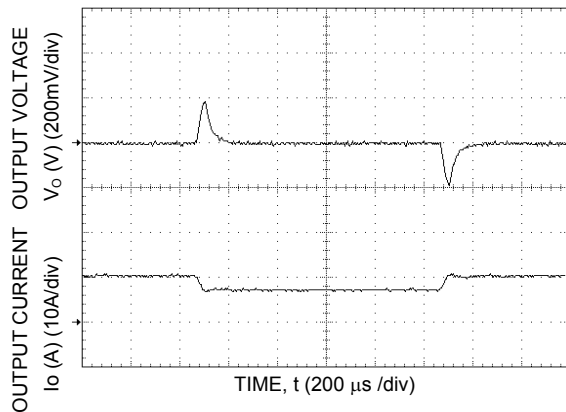

Figure 3. Transient Response to Dynamic Load Change, 0.1A/μs, from 75% to 50% to 75% of full load.

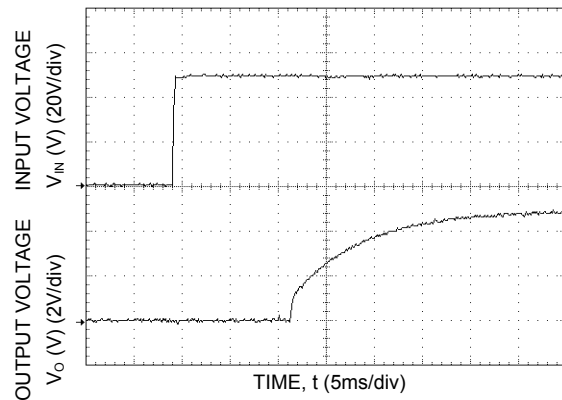

Figure 6. Typical Start-up Using Input Voltage ($V_{IN} = V_{IN,NOM}$, $I_o = I_{o,max}$).

Characteristic Curves

The following figures provide typical characteristics for the KNW020A0Fxx-88 (3.3V, 20A) at 25°C. The figures are identical for either positive or negative remote On/Off logic.

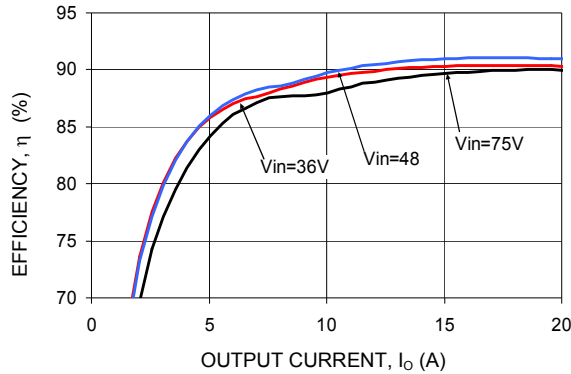

Figure 7. Converter Efficiency versus Output Current.

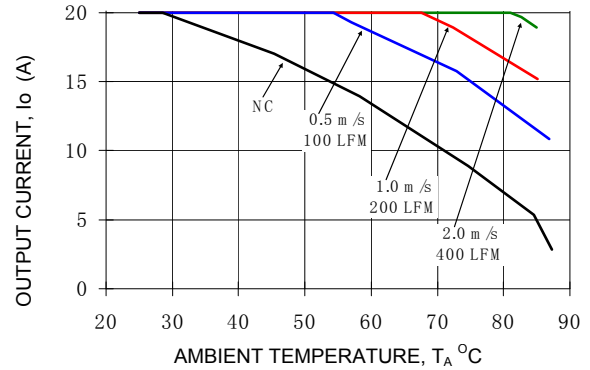

Figure 10. Derating Output Current versus Local Ambient Temperature and Airflow.

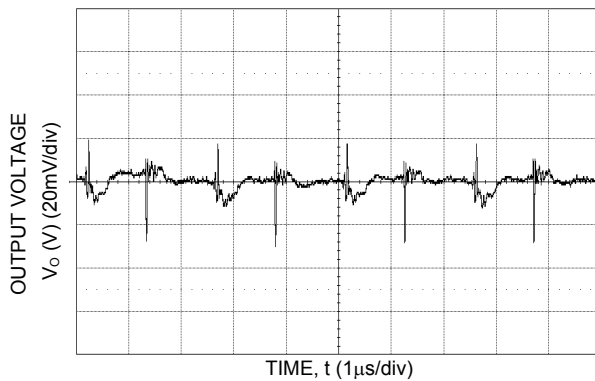

Figure 8. Typical output ripple and noise ($V_{IN} = V_{IN,NOM}$, $I_o = I_{o,max}$).

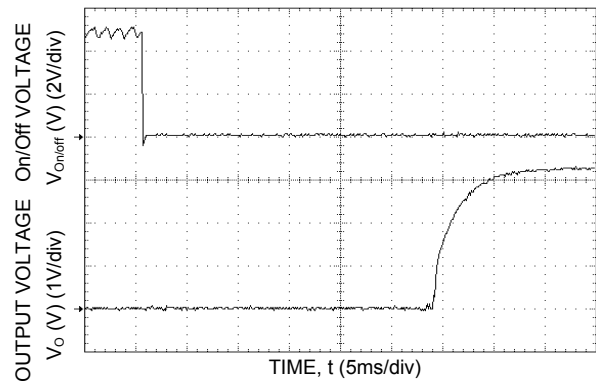

Figure 11. Typical Start-up Using Remote On/Off, negative logic version shown ($V_{IN} = V_{IN,NOM}$, $I_o = I_{o,max}$).

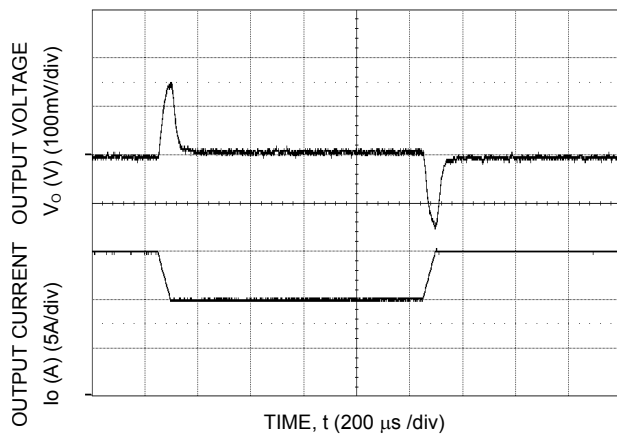

Figure 9. Transient Response to Dynamic Load Change, 0.1A/ μ S, from 75% to 50% to 75% of full load.

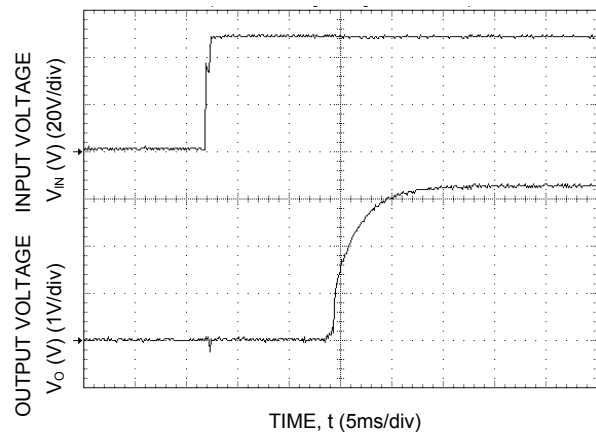
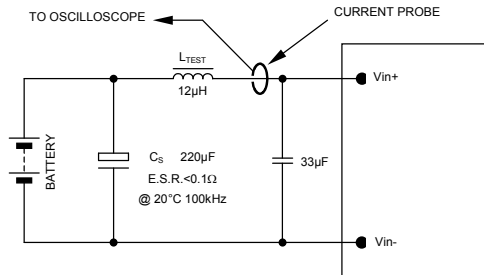

Figure 12. Typical Start-up Using Input Voltage ($V_{IN} = V_{IN,NOM}$, $I_o = I_{o,max}$).

Test Configurations



NOTE: Measure input reflected ripple current with a simulated source inductance (L_{TEST}) of 12µH. Capacitor C_S offsets possible battery impedance. Measure current as shown above.

Figure 13. Input Reflected Ripple Current Test Setup.

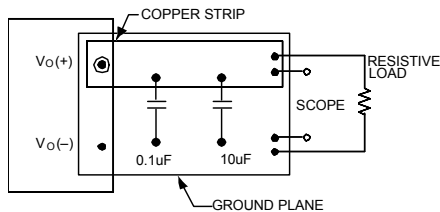

NOTE: All voltage measurements to be taken at the module terminals, as shown above. If sockets are used then Kelvin connections are required at the module terminals to avoid measurement errors due to socket contact resistance.

Figure 14. Output Ripple and Noise Test Setup.

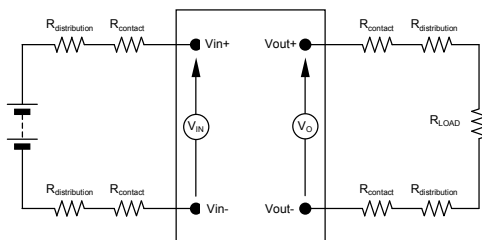

NOTE: All voltage measurements to be taken at the module terminals, as shown above. If sockets are used then Kelvin connections are required at the module terminals to avoid measurement errors due to socket contact resistance.

Figure 15. Output Voltage and Efficiency Test Setup.

$$\text{Efficiency } \eta = \frac{V_O \cdot I_O}{V_{IN} \cdot I_{IN}} \times 100 \%$$

Design Considerations

Input Filtering

The power module should be connected to a low ac-impedance source. Highly inductive source impedance can affect the stability of the power module. For the test configuration in Figure 13, a 33µF electrolytic capacitor (ESR < 0.7Ω at 100kHz), mounted close to the power module helps ensure the stability of the unit. Consult the factory for further application guidelines.

Safety Considerations

For safety-agency approval of the system in which the power module is used, the power module must be installed in compliance with the spacing and separation requirements of the end-use safety agency standard, i.e. UL60950-1, CSA C22.2 No.60950-1, and VDE0805-1(IEC60950-1).

If the input source is non-SELV (ELV or a hazardous voltage greater than 60 Vdc and less than or equal to 75Vdc), for the module's output to be considered as meeting the requirements for safety extra-low voltage (SELV), all of the following must be true:

- The input source is to be provided with reinforced insulation from any other hazardous voltages, including the ac mains.
- One V_{IN} pin and one V_{OUT} pin are to be grounded, or both the input and output pins are to be kept floating.
- The input pins of the module are not operator accessible.
- Another SELV reliability test is conducted on the whole system (combination of supply source and subject module), as required by the safety agencies, to verify that under a single fault, hazardous voltages do not appear at the module's output.

Note: Do not ground either of the input pins of the module without grounding one of the output pins. This may allow a non-SELV voltage to appear between the output pins and ground.

The power module has extra-low voltage (ELV) outputs when all inputs are ELV.

All flammable materials used in the manufacturing of these modules are rated 94V-0, or tested to the UL60950 A.2 for reduced thickness.

For input voltages exceeding –60 Vdc but less than or equal to –75 Vdc, these converters have been evaluated to the applicable requirements of BASIC INSULATION between secondary DC MAINS DISTRIBUTION input (classified as TNV-2 in Europe) and unearthed SELV outputs.

The input to these units is to be provided with a maximum 5 A time-delay fuse in the ungrounded lead.

Feature Description

Remote On/Off

Two remote on/off options are available. Positive logic turns the module on during a logic high voltage on the ON/OFF pin, and off during a logic low. Negative logic remote On/Off, device code suffix “1”, turns the module off during a logic high and on during a logic low.

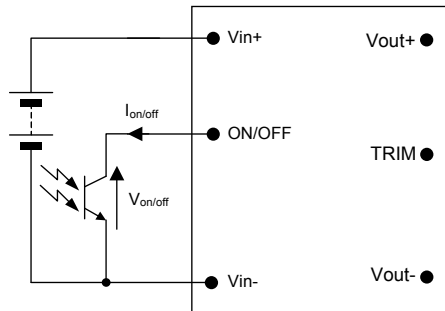

Figure 16. Remote On/Off Implementation.

To turn the power module on and off, the user must supply a switch (open collector or equivalent) to control the voltage ($V_{on/off}$) between the ON/OFF terminal and the $V_{IN(-)}$ terminal (see Figure 16). Logic low is $0V \leq V_{on/off} \leq 1.2V$. The maximum $I_{on/off}$ during a logic low is 1mA; the switch should be maintaining a logic low level while sinking this current.

During a logic high, the typical maximum $V_{on/off}$ generated by the module is 15V, and the maximum allowable leakage current at $V_{on/off} = 5V$ is 1 μ A.

If not using the remote on/off feature:

For positive logic, leave the ON/OFF pin open.

For negative logic, short the ON/OFF pin to $V_{IN(-)}$.

Remote Sense

Remote sense minimizes the effects of distribution losses by regulating the voltage at the remote-sense connections (See Figure 17). The voltage between the remote-sense pins and the output terminals must not exceed the output voltage sense range given in the Feature Specifications table:

$$[V_o(+)-V_o(-)] - [SENSE(+)-SENSE(-)] \leq 10\% V_{o,set}$$

Although the output voltage can be increased by both the remote sense and by the trim, the maximum increase for the output voltage is not the sum of both. The maximum increase is the larger of either the remote sense or the trim.

The amount of power delivered by the module is defined as the voltage at the output terminals multiplied by the output current. When using remote sense and trim, the output voltage of the module can be increased, which at the same output current would increase the power output of the module. Care should

be taken to ensure that the maximum output power of the module remains at or below the maximum rated power (Maximum rated power = $V_{o,set} \times I_{o,max}$).

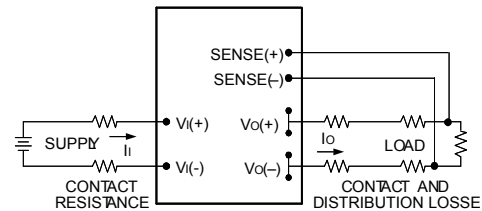

Figure 17. Circuit Configuration for remote sense.

Input Undervoltage Lockout

At input voltages below the input undervoltage lockout limit, the module operation is disabled. The module will only begin to operate once the input voltage is raised above the undervoltage lockout turn-on threshold, $V_{UV/ON}$.

Once operating, the module will continue to operate until the input voltage is taken below the undervoltage turn-off threshold, $V_{UV/OFF}$.

Overtemperature Protection

To provide protection under certain fault conditions, the unit is equipped with a thermal shutdown circuit. The unit will shutdown if the thermal reference point T_{ref} (Figure 19), exceeds 128-133°C (typical) depending on T_A and airflow, but the thermal shutdown is not intended as a guarantee that the unit will survive temperatures beyond its rating. The module will automatically restart upon cool-down to a safe temperature.

Output Overvoltage Protection

The output over voltage protection scheme of the modules has an independent over voltage loop to prevent single point of failure. This protection feature latches in the event of over voltage across the output. Cycling the on/off pin or input voltage resets the latching protection feature. If the auto-restart option (4) is ordered, the module will automatically restart upon an internally programmed time elapsing.

Overcurrent Protection

To provide protection in a fault (output overload) condition, the unit is equipped with internal current-limiting circuitry and can endure current limiting continuously. At the point of current-limit inception, the unit enters hiccup mode. If the unit is not configured with auto-restart, then it will latch off following the over current condition. The module can be restarted by cycling the dc input power for at least one second, or by toggling the remote on/off signal for at least one second. If the unit is configured with the

Feature Descriptions (continued)

auto-restart option (4), it will remain in the hiccup mode as long as the overcurrent condition exists; it operates normally, once the output current is brought back into its specified range. The average output current during hiccup is 10% I_{O, max}.

Output Voltage Programming

Trimming allows the output voltage set point to be increased or decreased. This is accomplished by connecting an external resistor between the TRIM pin and either the V_O(+) pin or the V_O(-) pin.

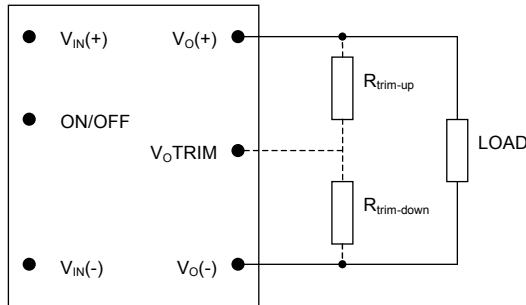

Figure 18. Circuit Configuration to Trim Output Voltage.

Connecting an external resistor (R_{trim-down}) between the TRIM pin and the V_O(-) (or Sense(-)) pin decreases the output voltage set point. To maintain set point accuracy, the trim resistor tolerance should be ±1.0%.

The following equation determines the required external resistor value to obtain a percentage output voltage change of Δ%

$$R_{trim-down} = \left[\frac{511}{\Delta\%} - 10.22 \right] K\Omega$$

Where $\Delta\% = \left(\frac{V_{o,set} - V_{desired}}{V_{o,set}} \right) \times 100$

For example, to trim-down the output voltage of 3.3V module (KNW020A0F/F1-88) by 8% to 3.036V, R_{trim-down} is calculated as follows:

$$\begin{aligned} \Delta\% &= 8 \\ R_{trim-down} &= \left[\frac{511}{8} - 10.22 \right] K\Omega \\ R_{trim-down} &= 53.6K\Omega \end{aligned}$$

Connecting an external resistor (R_{trim-up}) between the TRIM pin and the V_O(+) (or Sense (+)) pin increases the output voltage set point. The following equations determine the required external resistor value to obtain a percentage output voltage change of Δ%:

$$R_{trim-up} = \left[\frac{5.11 \times V_{o,set} \times (100 + \Delta\%)}{1.225 \times \Delta\%} - \frac{511}{\Delta\%} - 10.22 \right] K\Omega$$

Where $\Delta\% = \left(\frac{V_{desired} - V_{o,set}}{V_{o,set}} \right) \times 100$

For example, to trim-up the output voltage of 5.0V module (KNW013A0A/A1-88) by 5% to 5.25V, R_{trim-up} is calculated as follows:

$$\begin{aligned} \Delta\% &= 5 \\ R_{trim-up} &= \left[\frac{5.11 \times 5.0 \times (100 + 5)}{1.225 \times 5} - \frac{511}{5} - 10.22 \right] K\Omega \\ R_{trim-up} &= 325.6K\Omega \end{aligned}$$

The voltage between the V_O(+) and V_O(-) terminals must not exceed the minimum output overvoltage protection value shown in the Feature Specifications table. This limit includes any increase in voltage due to remote-sense compensation and output voltage set-point adjustment trim.

Although the output voltage can be increased by both the remote sense and by the trim, the maximum increase for the output voltage is not the sum of both. The maximum increase is the larger of either the remote sense or the trim. The amount of power delivered by the module is defined as the voltage at the output terminals multiplied by the output current. When using remote sense and trim, the output voltage of the module can be increased, which at the same output current would increase the power output of the module. Care should be taken to ensure that the maximum output power of the module remains at or below the maximum rated power (Maximum rated power = V_{o,set} × I_{o,max}).

Thermal Considerations

The power modules operate in a variety of thermal environments; however, sufficient cooling should be provided to help ensure reliable operation.

Considerations include ambient temperature, airflow, module power dissipation, and the need for increased reliability. A reduction in the operating temperature of the module will result in an increase in reliability. The thermal data presented here is based on physical measurements taken in a wind tunnel.

The thermal reference points, T_{ref,x}, used in the specifications are shown in Figure 19. For reliable operation, the temperature of both T_{ref} points should not exceed 125°C.

Thermal Considerations (continued)

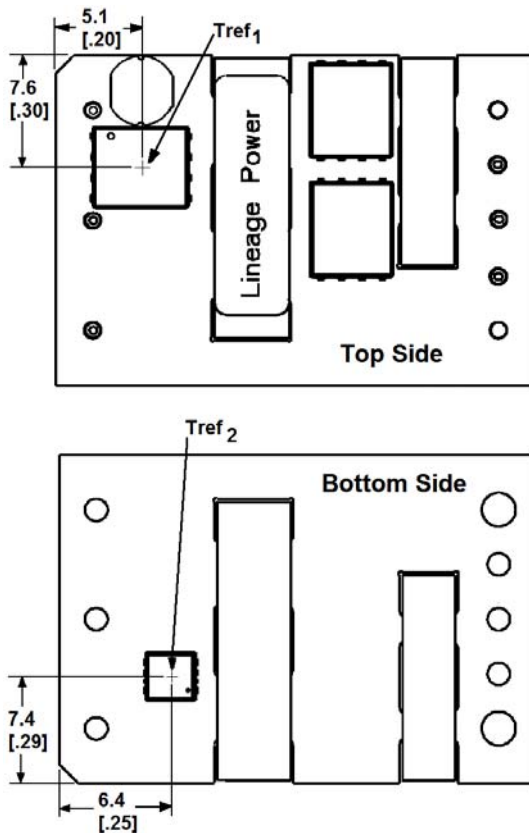

Figure 19. Tref_x Temperature Measurement Location.

Please refer to the Application Note “Thermal Characterization Process For Open-Frame Board-Mounted Power Modules” for a detailed discussion of thermal aspects including maximum device temperatures.

EMC Considerations

The KNW series module shall also meet limits of EN55022 Class A with a recommended single stage filter, shown in Figure 20. Please contact your Lineage Power Sales Representative for further information.

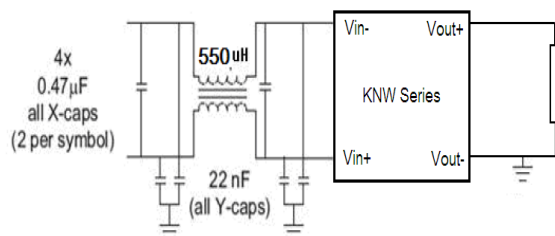

Figure 20. Single stage filter used for test results.

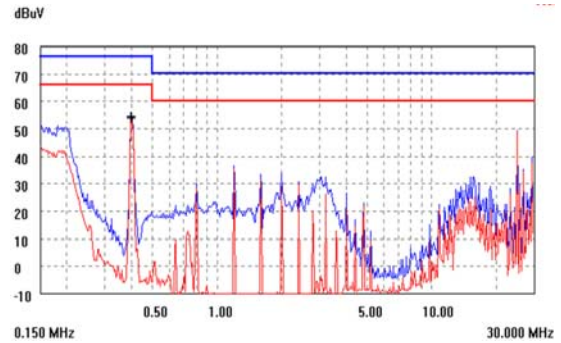

Figure 21. KNW020A0F-88 Quasi Peak Conducted Emissions with EN 55022 Class A limits, Figure 20 filter ($V_{IN} = V_{IN,NOM}$, $I_o = 0.80 I_{o,max}$).

Layout Considerations

Avoid placing copper areas on the outer layer of the application PCB directly underneath the power module in the keep out areas shown in the Recommended Pad Layout figures. Also avoid placing via interconnects underneath the power module in these keep out areas.

Surface Mount Information

Pick and Place

The KNW013/020-88 modules use an open frame construction and are designed for a fully automated assembly process. The pick and place locations on the module are the larger magnetic core or the transistor package as shown in Figure 22. The modules are fitted with a label which meets all the requirements for surface mount processing, as well as safety standards, and is able to withstand reflow temperatures of up to 300°C. The label also carries product information such as product code, serial number and the location of manufacture.

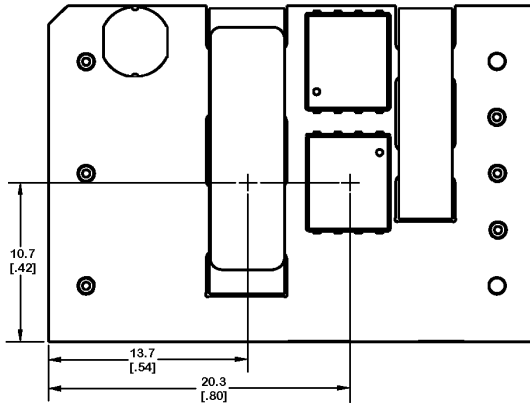

Figure 22. Pick and Place Locations.

Nozzle Recommendations

The module weight has been kept to a minimum by using open frame construction. Even so, these modules have a relatively large mass when compared to conventional SMT components. Variables such as nozzle size, tip style, vacuum pressure and placement speed should be considered to optimize this process. The recommended nozzle diameter for reliable operation is 5mm. Oblong or oval nozzles up to 11 x 5 mm may also be used within the space available.

Tin Lead Soldering

The KNW013/020-88 power modules (both non-Z and -Z codes) can be soldered either in a conventional Tin/Lead (Sn/Pb) process. The non-Z version of the KNW013/020-88 modules are RoHS compliant with the lead exception. Lead based solder paste is used in the soldering process during the manufacturing of these modules. These modules can only be soldered in conventional Tin/lead (Sn/Pb) process. It is recommended that the customer review data sheets in order to customize the solder reflow profile for each application board assembly. The following instructions must be observed when soldering these units. Failure to observe these instructions may result in the failure of or cause damage to the modules, and can adversely affect long-term reliability.

In a conventional Tin/Lead (Sn/Pb) solder process peak reflow temperatures are limited to less than 235°C. Typically, the eutectic solder melts at 183°C, wets the land, and subsequently wicks the device connection. Sufficient time must be allowed to fuse the plating on the connection to ensure a reliable solder joint. There are several types of SMT reflow technologies currently used in the industry. These surface mount power modules can be reliably soldered using natural forced convection, IR (radiant infrared), or a combination of convection/IR. For reliable soldering the solder reflow profile should be established by accurately measuring the modules CP connector temperatures.

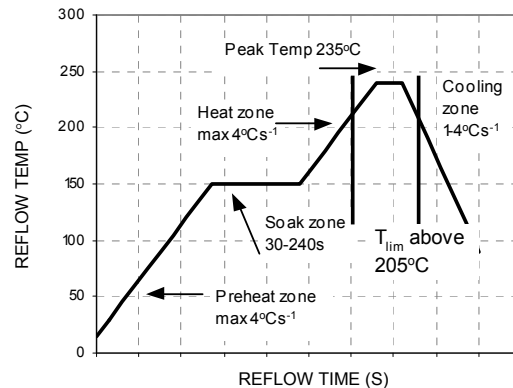

Figure 23. Reflow Profile for Tin/Lead (Sn/Pb) process

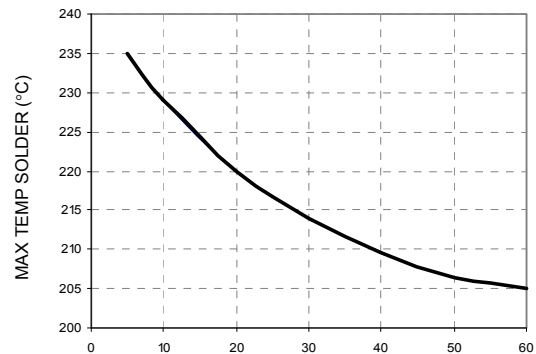

Figure 24. Time Limit Curve Above 205°C for Tin/Lead (Sn/Pb) process

Surface Mount Information (continued)

Lead Free Soldering

The –Z version of the KNW013/020-88 modules are lead-free (Pb-free) and RoHS compliant, and are both forward and backward compatible in a Pb-free and a SnPb soldering process. The non-Z version of the KNW013/020-88 modules are RoHS compliant with the lead exception. Lead based solder paste is used in the soldering process during the manufacturing of these modules. These modules can only be soldered in conventional Tin/lead (Sn/Pb) process. Failure to observe the instructions below may result in the failure of or cause damage to the modules and can adversely affect long-term reliability.

Pb-free Reflow Profile

Power Systems will comply with J-STD-020 Rev. C (Moisture/Reflow Sensitivity Classification for Nonhermetic Solid State Surface Mount Devices) for both Pb-free solder profiles and MSL classification procedures. This standard provides a recommended forced-air-convection reflow profile based on the volume and thickness of the package (table 4-2). The suggested Pb-free solder paste is Sn/Ag/Cu (SAC). The recommended linear reflow profile using Sn/Ag/Cu solder is shown in Figure 25.

MSL Rating

The KNW013/020-88 modules have a MSL rating of 3.

Storage and Handling

The recommended storage environment and handling procedures for moisture-sensitive surface mount packages is detailed in J-STD-033 Rev. A (Handling, Packing, Shipping and Use of Moisture/Reflow Sensitive Surface Mount Devices). Moisture barrier bags (MBB) with desiccant are required for MSL ratings of 2 or greater. These sealed packages should not be broken until time of use. Once the original package is broken, the floor life of the product at conditions of $\leq 30^{\circ}\text{C}$ and 60% relative humidity varies according to the MSL rating (see J-STD-033A). The shelf life for dry packed SMT packages will be a minimum of 12 months from the bag seal date, when stored at the following conditions: $< 40^{\circ}\text{C}$, $< 90\%$ relative humidity.

Post Solder Cleaning and Drying Considerations

Post solder cleaning is usually the final circuit-board assembly process prior to electrical board testing. The result of inadequate cleaning and drying can affect both the reliability of a power module and the testability of the finished circuit-board assembly. For guidance on appropriate soldering, cleaning and drying procedures, refer to Lineage Power *Board*

Mounted Power Modules: Soldering and Cleaning
Application Note (AN04-001).

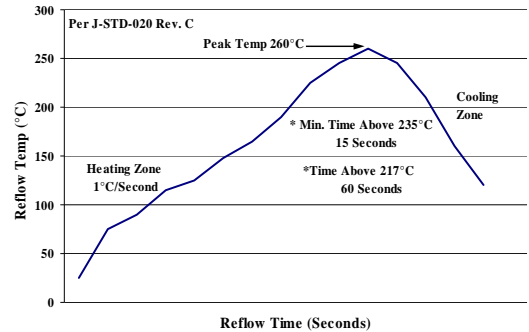

Figure 25. Recommended linear reflow profile using Sn/Ag/Cu solder.

Through-Hole Lead-Free Soldering Information

The RoHS-compliant through-hole products use the SAC (Sn/Ag/Cu) Pb-free solder and RoHS-compliant components. They are designed to be processed through single or dual wave soldering machines. The pins have an RoHS-compliant finish that is compatible with both Pb and Pb-free wave soldering processes. A maximum preheat rate of 3°C/s is suggested. The wave preheat process should be such that the temperature of the power module board is kept below 210°C . For Pb solder, the recommended pot temperature is 260°C , and, for Pb-free solder, the recommended pot temperature is 270°C max. Not all RoHS-compliant through-hole products can be processed with paste-through-hole Pb or Pb-free reflow process. If additional information is needed, please consult with your Lineage Power representative for more details.

Mechanical Outline for Surface Mount Module

Dimensions are in millimeters and [inches].

Tolerances: x.x mm ± 0.5 mm [x.xx in. ± 0.02 in.] (unless otherwise indicated)

x.xx mm ± 0.25 mm [x.xxx in ± 0.010 in.]

Top View

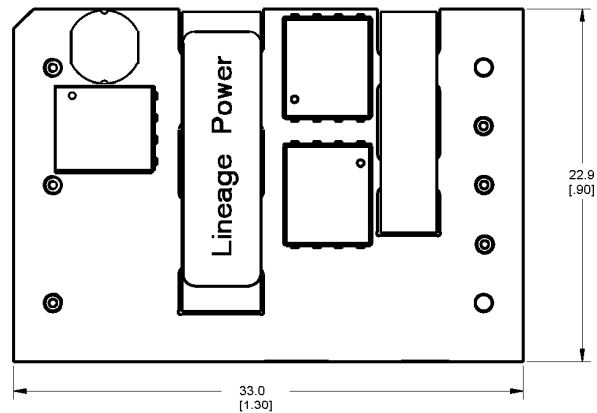

Side View

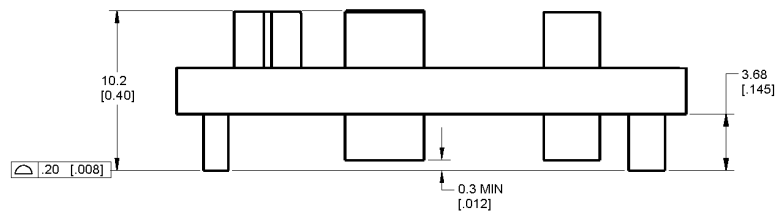

Bottom View

PIN	FUNCTION
1	V _{IN} (+)
2	On/Off
3	V _{IN} (-)
4	V _O (-)
5	Sense(-)
6	Trim
7	Sense(+)
8	V _O (+)

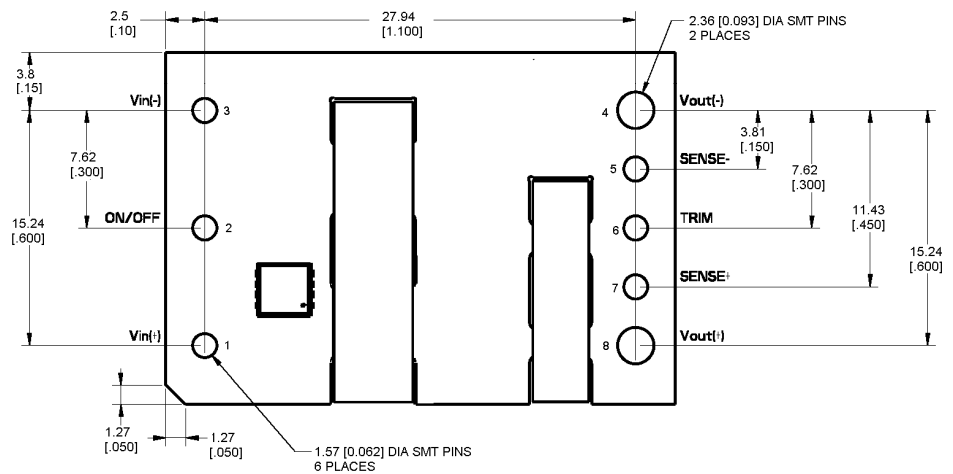

Mechanical Outline for Through-Hole Module

Dimensions are in millimeters and [inches].

Tolerances: x.x mm ± 0.5 mm [x.xx in. ± 0.02 in.] (unless otherwise indicated)

x.xx mm ± 0.25 mm [x.xxx in ± 0.010 in.]

Top View

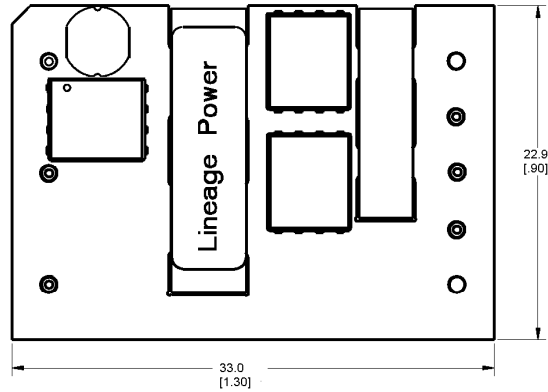

Side View

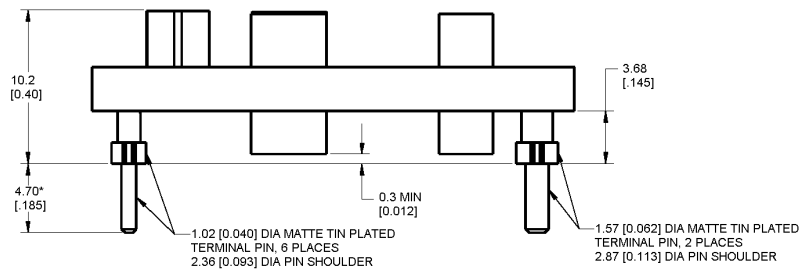

* FOR OPTIONAL PIN LENGTHS, SEE TABLE 2 DEVICE OPTIONS

Bottom View

PIN	FUNCTION
1	V _{IN} (+)
2	On/Off
3	V _{IN} (-)
4	V _O (-)
5	Sense(-)
6	Trim
7	Sense(+)
8	V _O (+)

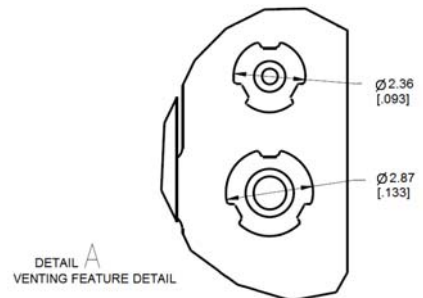
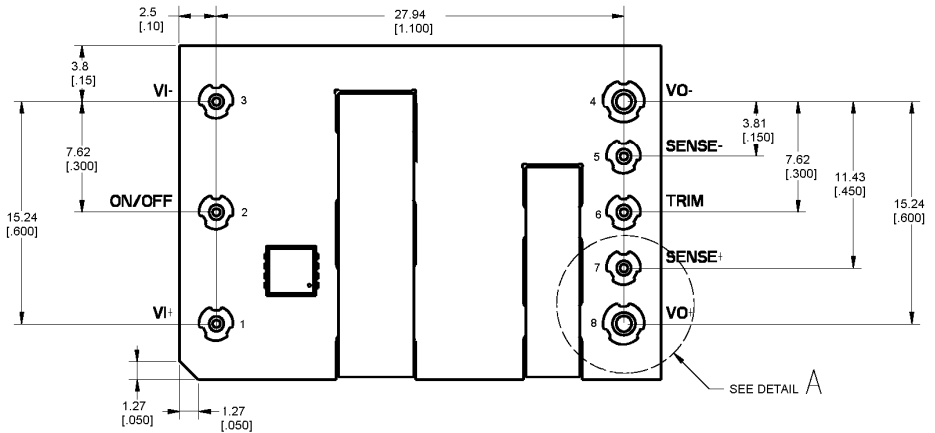

Recommended Pad Layout

Dimensions are in and millimeters [inches].

Tolerances: x.x mm ± 0.5 mm [x.xx in. ± 0.02 in.] (unless otherwise indicated)

x.xx mm ± 0.25 mm [x.xxx in ± 0.010 in.]

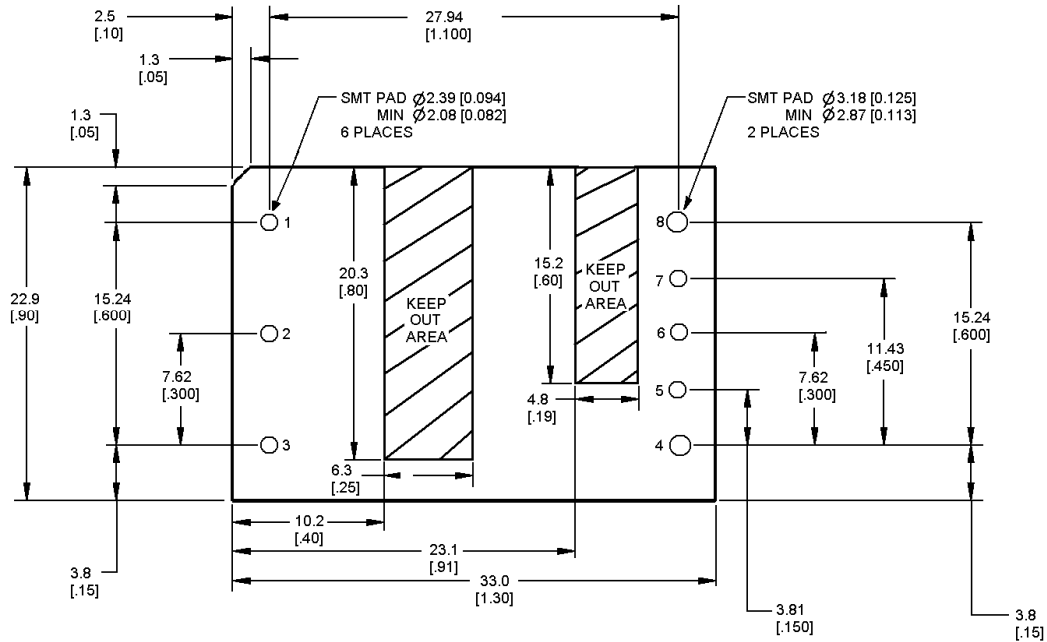

SMT Recommended Pad Layout (Component Side View)

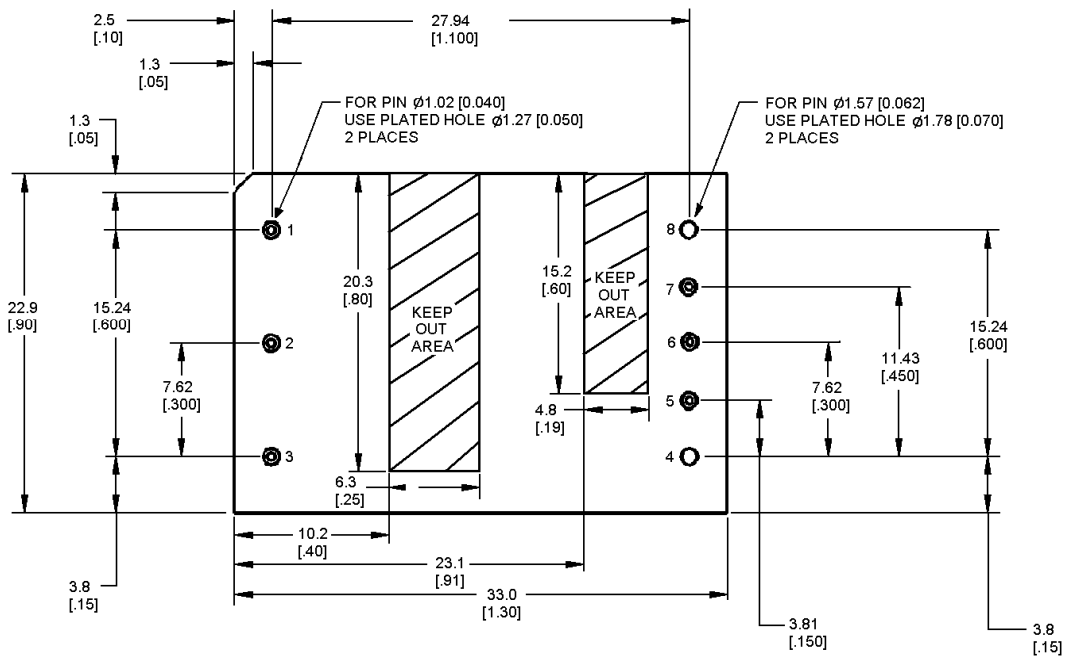

TH Recommended Pad Layout (Component Side View)

Packaging Details

The Sixteenth-brick SMT versions are supplied in tape & reel as standard. Details of tape dimensions are shown below. Modules are shipped in quantities of 140 modules per reel.

Tape Dimensions

Dimensions are in millimeters.

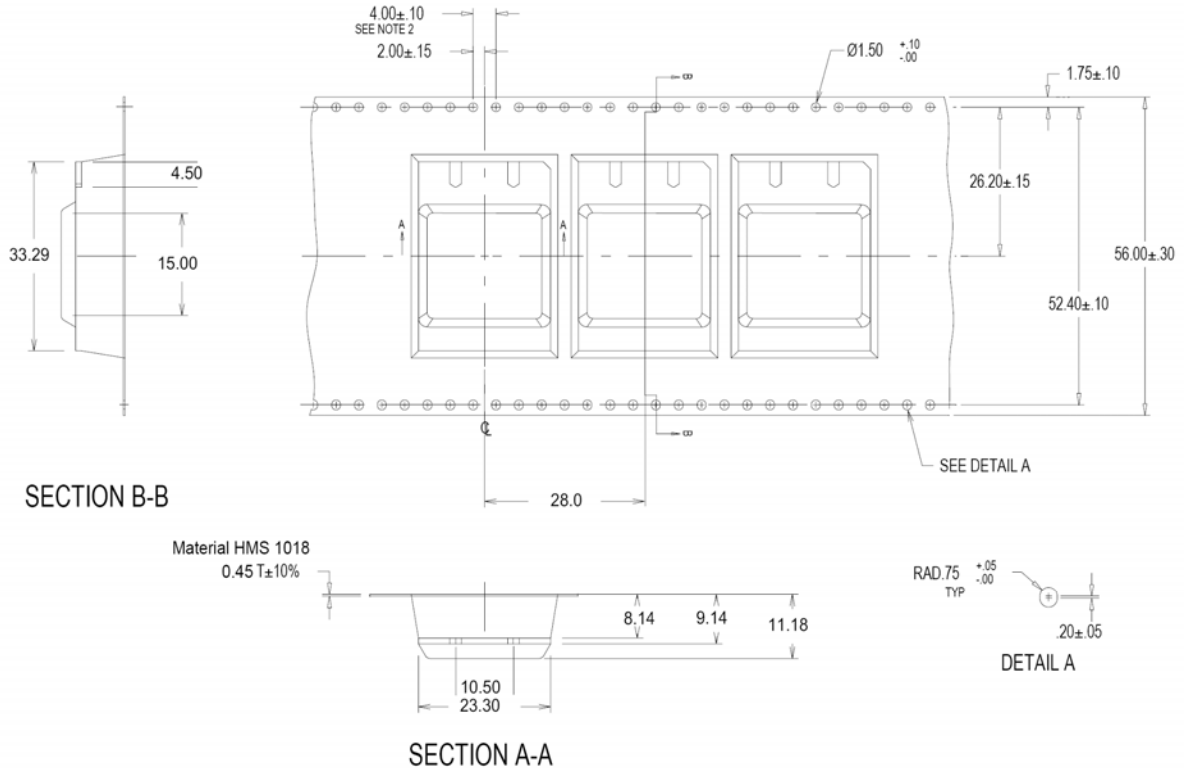

Ordering Information

Please contact your Lineage Power Sales Representative for pricing, availability and optional features.

Table 1. Device Code

Product Codes	Input Voltage	Output Voltage	Output Current	On/Off Logic	Connector Type	Comcode
KNW013A0A4-88SRZ	48V (36-75Vdc)	5.0V	13A	Positive	Surface mount	150027817
KNW013A0A41-88SRZ	48V (36-75Vdc)	5.0V	13A	Negative	Surface mount	150027812
KNW013A0A41-88Z	48V (36-75Vdc)	5.0V	13A	Negative	Through hole	150027809
KNW013A0A641-88Z	48V (36-75Vdc)	5.0V	13A	Negative	Through hole	150027816
KNW013A0A841-88Z	48V (36-75Vdc)	5.0V	13A	Negative	Through hole	150027811
KNW020A0F1-88SRZ	48V (36-75Vdc)	3.3V	20A	Negative	Surface mount	150027818
KNW020A0F41-88SRZ	48V (36-75Vdc)	3.3V	20A	Negative	Surface mount	150027810
KNW020A0F41-88Z	48V (36-75Vdc)	3.3V	20A	Negative	Through hole	150027806
KNW020A0F641-88Z	48V (36-75Vdc)	3.3V	20A	Negative	Through hole	150027807
KNW020A0F841-88Z	48V (36-75Vdc)	3.3V	20A	Negative	Through hole	150027814

Table 2. Device Coding Scheme and Options

	Characteristic	Character and Position	Definition
Ratings	Form Factor	K	K = Sixteenth Brick
	Family Designator	N	N=Family Designator
	Input Voltage	W	W = Wide Range, 36V-75V
	Output Current	013A0	013A0 = 013.0 Amps Maximum Output Current
		020A0	020A0 = 020.0 Amps Maximum Output Current
	Output Voltage	A	A = 5.0V nominal
F		F = 3.3V nominal	
Options	Pin Length	6	Omit = Default Pin Length shown in Mechanical Outline Figures 6 = Pin Length: 3.68 mm ± 0.25mm , (0.145 in. ± 0.010 in.)
		8	8 = Pin Length: 2.79 mm ± 0.25mm , (0.110 in. ± 0.010 in.)
	Action following Protective Shutdown	4	Omit = Latching Mode 4 = Auto-restart following shutdown (Overcurrent/Overvoltage)
	On/Off Logic	1	Omit = Positive Logic
			1 = Negative Logic
	Revision	88	88 = Updated Opto construction
	Mechanical Features	SR	Omit = Through Hole Pins S = Surface mount connections; R = Tape/reel packaging, included with S option
Customer Specific	XY	XY = Customer Specific Modified Code, Omit for Standard Code	
RoHS	Z	Omit = RoHS 5/6, Lead Based Solder Used	
		Z = RoHS 6/6 Compliant, Lead free	



World Wide Headquarters
Lineage Power Corporation
601 Shiloh Road, Plano, TX 75074, USA
+1-888-LINEAGE(546-3243)
(Outside U.S.A.: **+1-972-244-WATT(9288)**)
www.lineagepower.com
e-mail: techsupport1@lineagepower.com

Asia-Pacific Headquarters
Tel: +86.021.54279977*808

Europe, Middle-East and Africa Headquarters
Tel: +49.89.878067-280

India Headquarters
Tel: +91.80.28411633

Lineage Power reserves the right to make changes to the product(s) or information contained herein without notice. No liability is assumed as a result of their use or application. No rights under any patent accompany the sale of any such product(s) or information.

Lineage Power DC-DC products are protected under various patents. Information on these patents is available at www.lineagepower.com/patents.

© 2010 Lineage Power Corporation, (Plano, Texas) All International Rights Reserved.