

POWER RELAY

1 POLE - 5A, TV-3 / TV-5 TYPE

FTR-F3 Series

■ FEATURES

- High inrush 50A/80A, TV rating capability
- Flat and slim power relays
 - Flat type (right angle type): height: 7mm
Mounting space: 330mm²
 - Slim type (standard type)
Width: 7mm
Mounting space: 142mm²
- High inrush current contacts
- High insulation
Insulation distance: minimum 6mm between coil and contact (conforms to IEC 60065)
Dielectric strength: 4KV
Surge strength: 10KV
- Cadmium free contact for eco-program
- Safety standards
UL, CSA, VDE, SEMKO
- Plastic sealed relay, RTIII
- RoHS compliant
Please see page 5 for more information



■ PARTNUMBER INFORMATION

[Example] FTR-F3 P A 012 V
 (a) (b) (c) (d) (e)

(a)	Relay type	FTR-F3 :FTR-F3-Series
(b)	Contact configuration	A : 1 form A, straight terminals P : 1 form A, right angle terminals
(c)	Coil type (power)	A : 280mW, TV3 and TV5 types, FTR-F3(A;P)A(...) (V;T)
(d)	Coil rated voltage	012 : 5.....24 VDC Coil rating table at page 3
(e)	Contact material	V : AgSnO ₂ TV5 type, 1 form A type only (280mW coil) T : AgSnO ₂ TV3 type, 1 form A type only (280mW coil)

Actual marking does not carry the type name : "FTR"

E.g.: Ordering code: FTR-F3PA012V

Actual marking: F3PA012V

FTR-F3 SERIES

■ SPECIFICATION

Item	FTR-F3			
	FTR-F3(A;P)A(...)V	FTR-F3(A;P)A(...)T		
Contact Data	Configuration	1 form A (SPST)		
	Construction	Single		
	Material	T and V: AgSnO ₂ May or may be not gold plated		
	Resistance (initial)	Max. 100mOhm at 1A, 6VDC		
	Contact rating (resistive)	5A, 250VAC, 30VDC		
	Max. carrying current	5A		
	Max. switching voltage	277VAC, 150VDC		
	Max. switching power	1,250VA, 150W		
	Min. switching load *	10 mA, 5VDC		
Life	Mechanical	Min. 5 x 10 ⁶ operations		
	Electrical (resistive)	Min. 100 x 10 ³ operations (3A, 250VAC/30VDC) Min. 50 x 10 ³ operations (5A, 250VAC/30VDC)		
	Electrical (lamp)	Min. 25 x 10 ³ operations (UL, TV-5)	Min. 25 x 10 ³ operations (UL, TV-3)	
Coil Data	Rated power (20 °C)	280mW		
	Operate power	156mW		
	Operating temperature range	-40 °C to +85 °C (no frost)		
Timing Data	Operate (at nominal voltage)	Max. 10ms (without bounce, no diode)		
	Release (at nominal voltage)	Max. 10ms (without bounce, no diode)		
Insulation	Resistance (initial)	Min. 1,000MOhm at 500VDC		
	Dielectric strength	Open contacts	750VAC (50/60Hz) 1min	
		Contacts to coil	4,000VAC (50/60Hz) 1min	
	Surge strength	Contacts to coil	10,000V / 1.2 x 50µs standard wave	
	Clearance	6mm		
	Creepage	6mm		
	EN61810-1, VDE0435	Voltage	250V	
		Pollution degree	2	
Material group		III		
Other	Vibration resistance	Misoperation	10 to 55Hz double amplitude 1.5mm	
		Endurance	10 to 55Hz double amplitude 1.5mm	
	Shock	Misoperation	Min. 100m/s ² (11±1ms)	
		Endurance	Min. 1,000m/s ² (6±1ms)	
	Weight	Approximately 6g		
	Sealing	Plastic sealed RTIII		

* Minimum switching loads mentioned above are reference values. Please perform the confirmation test with actual load before production since reference values may vary according to switching frequencies, environmental conditions and expected reliability levels.

■ COIL RATING

280mW type

Coil Code	Rated Coil Voltage (VDC)	Coil Resistance +/- 10% (Ohm)	Must Operate Voltage (VDC) *	Must Release Voltage (VDC) *	Max. Coil Voltage (VDC)	Rated Power (mW)
005	5	90	3.75	0.5	10	280
006	6	130	4.5	0.6	12	
009	9	290	6.75	0.9	19	
012	12	515	9	1.2	26	
018	18	1,160	13.5	1.8	39	
024	24	2,060	18	2.4	52	

Note: All values in the tables are valid for 20°C and zero contact current.

* Specified operate values are valid for pulse wave voltage.

■ SAFETY STANDARDS

Type	Compliance	Contact rating
UL	UL 508	Flammability: UL 94-V0 (plastics)
	E63614	FTR-PA(...)V, FTR-F3AA(...)V 3A, 250VAC / 30VDC resistive, 10K operations
CSA	C22.2 No. 14 LR 40304	5A, 250VAC / 30VDC resistive TV-5, 120VAC, 25K operations FTR-F3PA(...)T, FTR-F3AA(...)T 3A, 250VAC/30VDC resistive, 10K operations 5A, 250VAC/30VDC resistive TV-3, 120VAC, 25K operations
VDE	IEC/EN61810-1	FTR-F3PA(...)V, FTR-F3AA(...)V 3A, 250 VAC, $\cos\phi = 1$, 100×10^3 , 85°C 5A, 250 VAC, $\cos\phi = 1$, 50×10^3 , 85°C 8A, 250VAC, $\cos\phi = 1$, 6×10^3 , 85°C 3A, 30VDC (0ms), 70×10^3 , 85°C 5A, 30VDC (0ms), 50×10^3 , 85°C 8A, 30VDC, $\tau=0\text{msec}$, 6×10^3 , 85°C FTR-F3PA(...)T, FTR-F3AA(...)T 3A, 250 VAC, $\cos\phi = 1$, 100×10^3 , 85°C 5A, 250 VAC, $\cos\phi = 1$, 50×10^3 , 85°C 3A, 30VDC (0ms), 70×10^3 , 85°C 5A, 30VDC (0ms), 50×10^3 , 85°C
SEMKO	EN 61058-1: 1992 +A1:1993 EN 61095:1993+A11	FTR-F3PA(...)V, FTR-F3AA(...)V 3A 30VDC, 5A 250VAC/30VDC T85 3/40A 250VAC, 5/40A 250VAC T85 FTR-F3PA(...)T, FTR-F3AA(...)T 3A 250VAC/30VDC, 5A 30VDC T85 3/51A 125VAC, 3/30A 250VAC T85

CHARACTERISTIC DATA

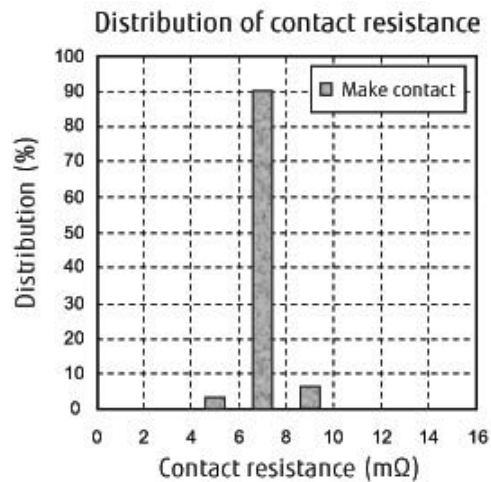
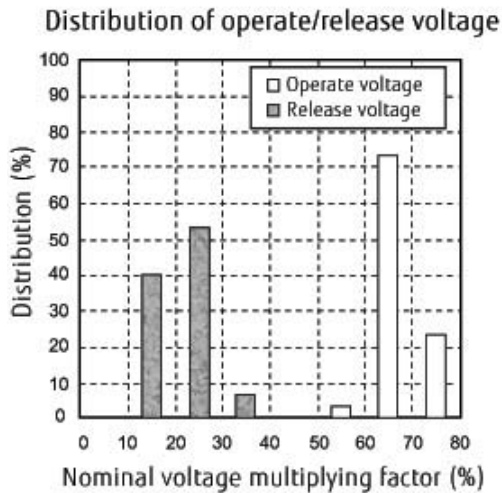
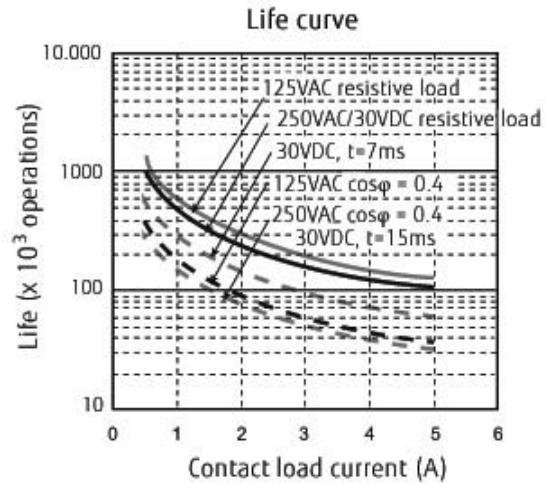
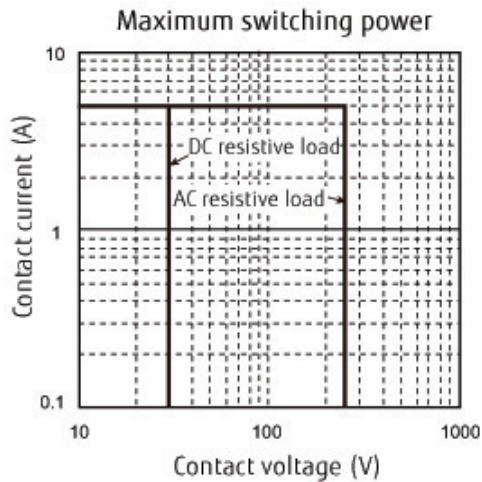
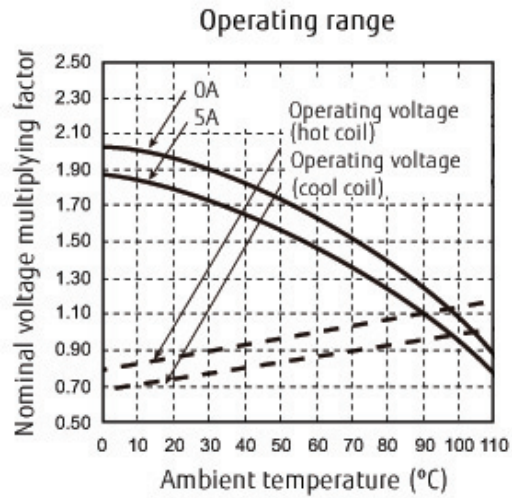
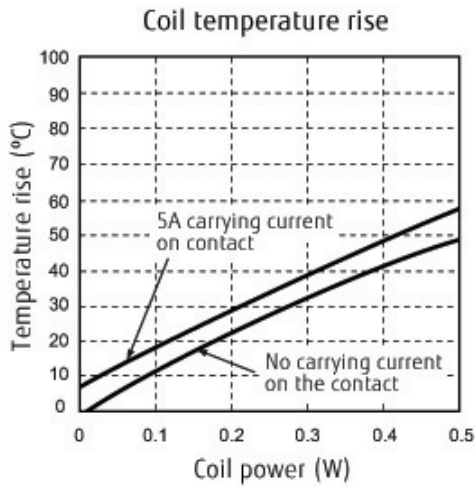

■ DIMENSIONS

Standard type - FTR-F3AA(...)(V,T)

- Dimensions

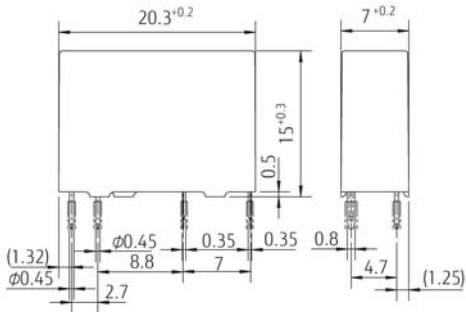

- Schematics (BOTTOM VIEW)

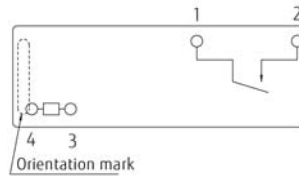

- PC board mounting hole layout (BOTTOM VIEW)

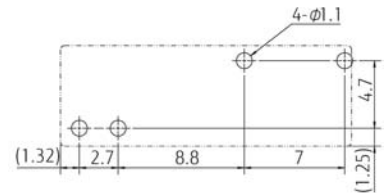

Right angle type - FTR-F3PA(...)(V,T)

- Dimensions

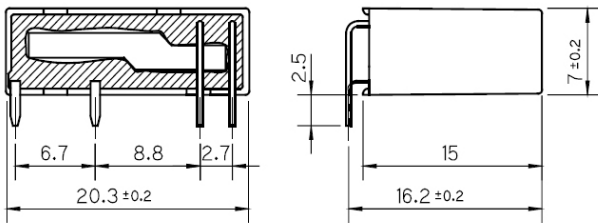

- Schematics (BOTTOM VIEW)

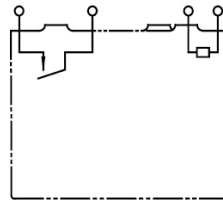

- PC board mounting hole layout (BOTTOM VIEW)

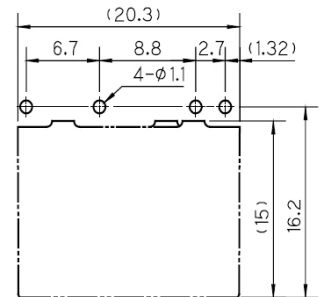

Unit: mm

RoHS Compliance and Lead Free Information

1. General Information

- All signal and power relays produced by Fujitsu Components are compliant with RoHS directive 2002/95EC including amendments.
- Cadmium as used in electrical contacts is exempted from the RoHS directives on October 21st, 2005. (Amendment to Directive 2002/95/EC)
- All of our signal and power relays are lead-free. Please refer to Lead-Free Status Info for older date codes at: <http://www.fujitsu.com/us/downloads/MICRO/fcai/relays/lead-free-letter.pdf>
- Lead free solder plating on relay terminals is Sn-3.0Ag-0.5Cu, unless otherwise specified. This material has been verified to be compatible with PbSn assembly process.

2. Recommended Lead Free Solder Profile

- **Recommended solder Sn-3.0Ag-0.5Cu.**

Flow Solder condition:

Pre-heating: maximum 120°C
Soldering: dip within 5 sec. at
260°C solder bath

Solder by Soldering Iron:

Soldering Iron
Temperature: maximum 360°C
Duration: maximum 3 sec.

We highly recommend that you confirm your actual solder conditions

3. Moisture Sensitivity

- Moisture Sensitivity Level standard is not applicable to electromechanical relays, unless otherwise indicated.

4. Tin Whiskers

- Dipped SnAgCu solder is known as presenting a low risk to tin whisker development. No considerable length whisker was found by our in house test.

Fujitsu Components International Headquarter Offices

Japan

Fujitsu Component Limited
Gotanda-Chuo Building
3-5, Higashigotanda 2-chome, Shinagawa-ku
Tokyo 141, Japan
Tel: (81-3) 5449-7010
Fax: (81-3) 5449-2626
Email: promothq@ft.ed.fujitsu.com
Web: www.fcl.fujitsu.com

North and South America

Fujitsu Components America, Inc.
250 E. Caribbean Drive
Sunnyvale, CA 94089 U.S.A.
Tel: (1-408) 745-4900
Fax: (1-408) 745-4970
Email: components@us.fujitsu.com
Web: <http://us.fujitsu.com/components>

Europe

Fujitsu Components Europe B.V.
Diamantlaan 25
2132 WV Hoofddorp
Netherlands
Tel: (31-23) 5560910
Fax: (31-23) 5560950
Email: info@fceu.fujitsu.com
Web: emea.fujitsu.com/components/

Asia Pacific

Fujitsu Components Asia Ltd.
102E Pasir Panjang Road
#01-01 Citilink Warehouse Complex
Singapore 118529
Tel: (65) 6375-8560
Fax: (65) 6273-3021
Email: fcalfcal.fujitsu.com
Web: <http://www.fujitsu.com/sg/services/micro/components/>

©2012 Fujitsu Components Europe B.V. All rights reserved. All trademarks or registered trademarks are the property of their respective owners.

The contents, data and information in this datasheet are provided by Fujitsu Component Ltd. as a service only to its user and only for general information purposes.

The use of the contents, data and information provided in this datasheet is at the users' own risk.

Fujitsu has assembled this datasheet with care and will endeavor to keep the contents, data and information correct, accurate, comprehensive, complete and up to date.

Fujitsu Components Europe B.V. and affiliated companies do however not accept any responsibility or liability on their behalf, nor on behalf of its employees, for any loss or damage, direct, indirect or consequential, with respect to this datasheet, its contents, data, and information and related graphics and the correctness, reliability, accuracy, comprehensiveness, usefulness, availability and completeness thereof.

Nor do Fujitsu Components Europe B.V. and affiliated companies accept on their behalf, nor on behalf of its employees, any responsibility or liability for any representation or warrant of any kind, express or implied, including warranties of any kind for merchantability or fitness for particular use, with respect to these datasheets, its contents, data, information and related graphics and the correctness, reliability, accuracy, comprehensiveness, usefulness, availability and completeness thereof. Rev. April 26, 2012