

PKJ 7200 series Direct Converters Input
60-160 V, Output up to 16.8 A / 200 W

28701-BMR 714 Rev B

November 2019

© Flex

Key Features

- Industry standard case dimensions
61.0*57.9*12.7 mm (2.40*2.28*0.5 in)
- High Efficiency up to 93%
- 4000 Vdc input to output isolation
- Meets safety requirements according to IEC/EN/UL 62368-1
- Meet Requirements of standard EN50155
- EN45545-2 compliant



General Characteristics

- Input under voltage shutdown
- Remote control
- Output over voltage protection
- Over temperature protection
- Output short-circuit protection
- Output voltage adjust function
- ISO 9001/14001 certified supplier

Safety Approvals



Design for Environment



Meets requirements in high-temperature lead-free soldering processes.

Contents

Ordering Information	2
General Information	2
Safety Specification	3
Absolute Maximum Ratings	4
Electrical Specification	
12V, 16.8A / 200W	PKJ7213PI..... 6
13.8V, 14.5A / 200W	PKJ7217KPI 10
15V, 13.5A / 200W	PKJ7215PI..... 14
24V, 8.4A / 200W	PKJ7216ZPI 18
48V, 4.2A / 200W	PKJ7216JPI..... 22
54V, 3.8A / 200W	PKJ7216HPI..... 26
EMC Specification	30
Operating Information	32
Thermal Consideration	33
Connections	34
Mechanical Information	35
Soldering Information	36
Delivery Information	36
Product Qualification Specification	37

Technical Specification

PKJ 7200 series Direct Converters Input
60-160 V, Output up to 16.8 A / 200 W

28701-BMR 714 Rev B November 2019

© Flex

Ordering Information

Product program	Output
PKJ7213PI	12V, 16.8A / 200 W
PKJ7217KPI	13.8V, 14.5A / 200 W
PKJ7215PI	15V, 13.5A / 200 W
PKJ7216ZPI	24V, 8.4A / 200 W
PKJ7216JPI	48V, 4.2A / 200 W
PKJ7216HPI	54V, 3.8A / 200 W

Product number and Packaging

PKJ721XXPI n ₁	
Options	n ₁
Remote Control logic	o

Options	Description
n ₁	Negative* P Positive

Example: a product with positive logic, tray packaging would be PKJ721XXPIP.

* Standard variant (i.e. no option selected).

General Information

Reliability

The failure rate (λ) and mean time between failures (MTBF = $1/\lambda$) is calculated at max output power and an operating ambient temperature (T_A) of +40°C. Flex uses Telcordia SR-332 Issue 3 Method 1 to calculate the mean steady-state failure rate and standard deviation (σ).

Telcordia SR-332 Issue 3 also provides techniques to estimate the upper confidence levels of failure rates based on the mean and standard deviation.

Mean steady-state failure rate, λ	Std. deviation, σ
221.651 nFailures/h	326.024 nFailures/h

MTBF (mean value) for the PKJ series = 4.51 Mh.
MTBF at 90% confidence level = 2.84 Mh

Compatibility with RoHS requirements

The products are compatible with the relevant clauses and requirements of the RoHS directive 2011/65/EU and have a maximum concentration value of 0.1% by weight in homogeneous materials for lead, mercury, hexavalent chromium, PBB and PBDE and of 0.01% by weight in homogeneous materials for cadmium.

Exemptions in the RoHS directive utilized in Flex products are found in the Statement of Compliance document.

Flex fulfills and will continuously fulfill all its obligations under regulation (EC) No 1907/2006 concerning the registration, evaluation, authorization and restriction of chemicals (REACH) as they enter into force and is through product materials declarations preparing for the obligations to communicate information on substances in the products.

Quality Statement

The products are designed and manufactured in an industrial environment where quality systems and methods like ISO 9000, Six Sigma, and SPC are intensively in use to boost the continuous improvements strategy. Infant mortality or early failures in the products are screened out and they are subjected to an ATE-based final test. Conservative design rules, design reviews and product qualifications, plus the high competence of an engaged work force, contribute to the high quality of the products.

Warranty

Warranty period and conditions are defined in Flex General Terms and Conditions of Sale.

Limitation of Liability

Flex does not make any other warranties, expressed or implied including any warranty of merchantability or fitness for a particular purpose (including, but not limited to, use in life support applications, where malfunctions of product can cause injury to a person's health or life).

© Flex 2019

The information and specifications in this technical specification is believed to be correct at the time of publication. However, no liability is accepted for inaccuracies, printing errors or for any consequences thereof. Flex reserves the right to change the contents of this technical specification at any time without prior notice.

Technical Specification

PKJ 7200 series Direct Converters Input 60-160 V, Output up to 16.8 A / 200 W	28701-BMR 714 Rev B	November 2019
	© Flex	

Safety Specification**General information**

Flex Power DC/DC converters and DC/DC regulators are designed in accordance with the safety standards IEC 62368-1, EN 62368-1 and UL 62368-1 *Audio/video, information and communication technology equipment - Part 1: Safety requirements*

IEC/EN/UL 62368-1 contains requirements to prevent injury or damage due to the following hazards:

- Electrical shock
- Electrically-caused fire
- Injury caused by hazardous substances
- Mechanically-caused injury
- Skin burn
- Radiation-caused injury

On-board DC/DC converters, Power interface modules and DC/DC regulators are defined as component power supplies. As components they cannot fully comply with the provisions of any safety requirements without "conditions of acceptability". Clearance between conductors and between conductive parts of the component power supply and conductors on the board in the final product must meet the applicable safety requirements. Certain conditions of acceptability apply for component power supplies with limited stand-off (see Mechanical Information for further information). It is the responsibility of the installer to ensure that the final product housing these components complies with the requirements of all applicable safety standards and regulations for the final product.

Component power supplies for general use shall comply with the requirements in IEC/EN/UL 62368-1. Product related standards, e.g. IEEE 802.3af *Power over Ethernet*, and ETS-300132-2 *Power interface at the input to telecom equipment, operated by direct current (dc)* are based on IEC/EN/UL 60950-1 with regards to safety.

Flex Power DC/DC converters, Power interface modules and DC/DC regulators are UL 62368-1 recognized and certified in accordance with EN 62368-1. The flammability rating for all construction parts of the products meet requirements for V-0 class material according to IEC 60695-11-10, *Fire hazard testing, test flames – 50 W* horizontal and vertical flame test methods.

Isolated DC/DC converters & Power interface modules

The product may provide basic or functional insulation between input and output according to IEC/EN/UL 62368-1 (see Safety Certificate), different conditions shall be met if the output of a basic or a functional insulated product shall be considered as ES1 energy source.

For basic insulated products (see Safety Certificate) the output is considered as ES1 energy source if one of the

following conditions is met:

- The input source provides supplementary or double or reinforced insulation from the AC mains according to IEC/EN/UL 62368-1.
- The input source provides functional or basic insulation from the AC mains and the product's output is reliably connected to protective earth according to IEC/EN/UL 62368-1.

For functional insulated products (see Safety Certificate) the output is considered as ES1 energy source if one of the following conditions is met:

- The input source provides double or reinforced insulation from the AC mains according to IEC/EN/UL 62368-1.
- The input source provides basic or supplementary insulation from the AC mains and the product's output is reliably connected to protective earth according to IEC/EN/UL 62368-1.
- The input source is reliably connected to protective earth and provides basic or supplementary insulation according to IEC/EN/UL 62368-1 and the maximum input source voltage is 60 Vdc.

Galvanic isolation between input and output is verified in an electric strength test and the isolation voltage (V_{iso}) meets the voltage strength requirement for basic insulation according to IEC/EN/UL 62368-1.

It is recommended to use a slow blow fuse at the input of each DC/DC converter. If an input filter is used in the circuit the fuse should be placed in front of the input filter. In the rare event of a component problem that imposes a short circuit on the input source, this fuse will provide the following functions:

- Isolate the fault from the input power source so as not to affect the operation of other parts of the system
- Protect the distribution wiring from excessive current and power loss thus preventing hazardous overheating

Technical Specification

PKJ 7200 series Direct Converters Input
60-160 V, Output up to 16.8 A / 200 W

28701-BMR 714 Rev B November 2019
© Flex

Absolute Maximum Ratings

Characteristics		min	typ	max	Unit
T_{P1}	Operating Temperature (see Thermal Consideration section)	-40		+110	°C
T_S	Storage temperature	-55		+125	°C
V_I	Input voltage	60	110	160	V
V_{iso}	Isolation voltage (Input to Output)			4000	Vdc
V_{iso}	Isolation voltage (Input to Baseplate)			2250	Vdc
V_{iso}	Isolation voltage (Baseplate to Output)			1600	Vdc
V_{tr}	Input voltage transient (tp 1s)			200	V
V_{RC}	Remote Control pin voltage (see Operating Information section)	Positive logic option		5	V
		Negative logic option	0	5	V

Stresses above those listed under Absolute Maximum Ratings may cause permanent damage to the device. This is a stress rating only; functional operation of the device at these or any other conditions above those indicated in the Electrical Specification section of this specification is not implied. Exposure to absolute maximum rating conditions for extended periods may affect device reliability.

Fundamental Circuit Diagram For PKJ7217KPI(P)

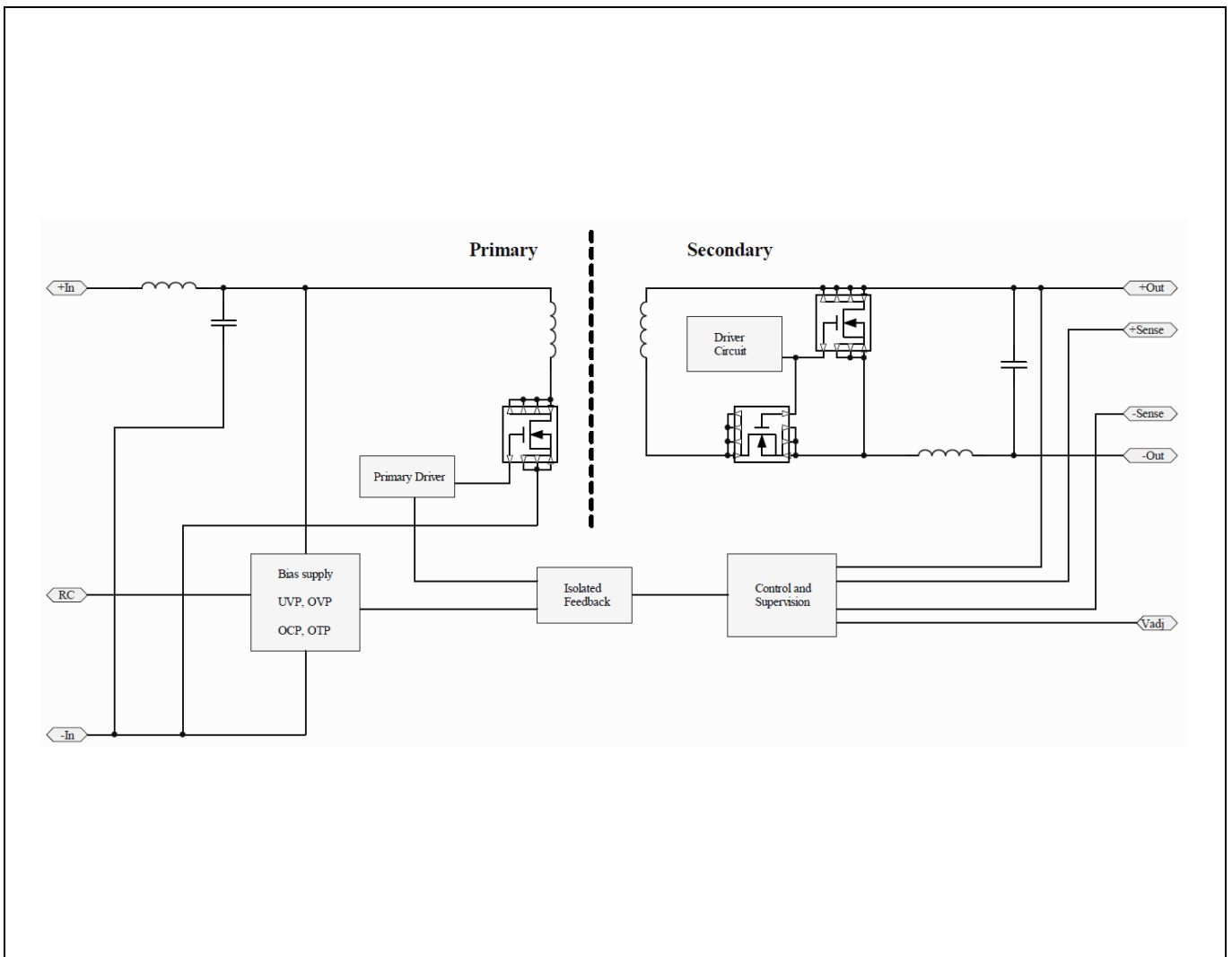

PKJ 7200 series Direct Converters Input
60-160 V, Output up to 16.8 A / 200 W

28701-BMR 714 Rev B November 2019
© Flex

Fundamental Circuit Diagram For PKJ7213PI(P), PKJ7215PI(P),PKJ7216ZPI(P),PKJ7216JPI(P), PKJ7216HPI(P)

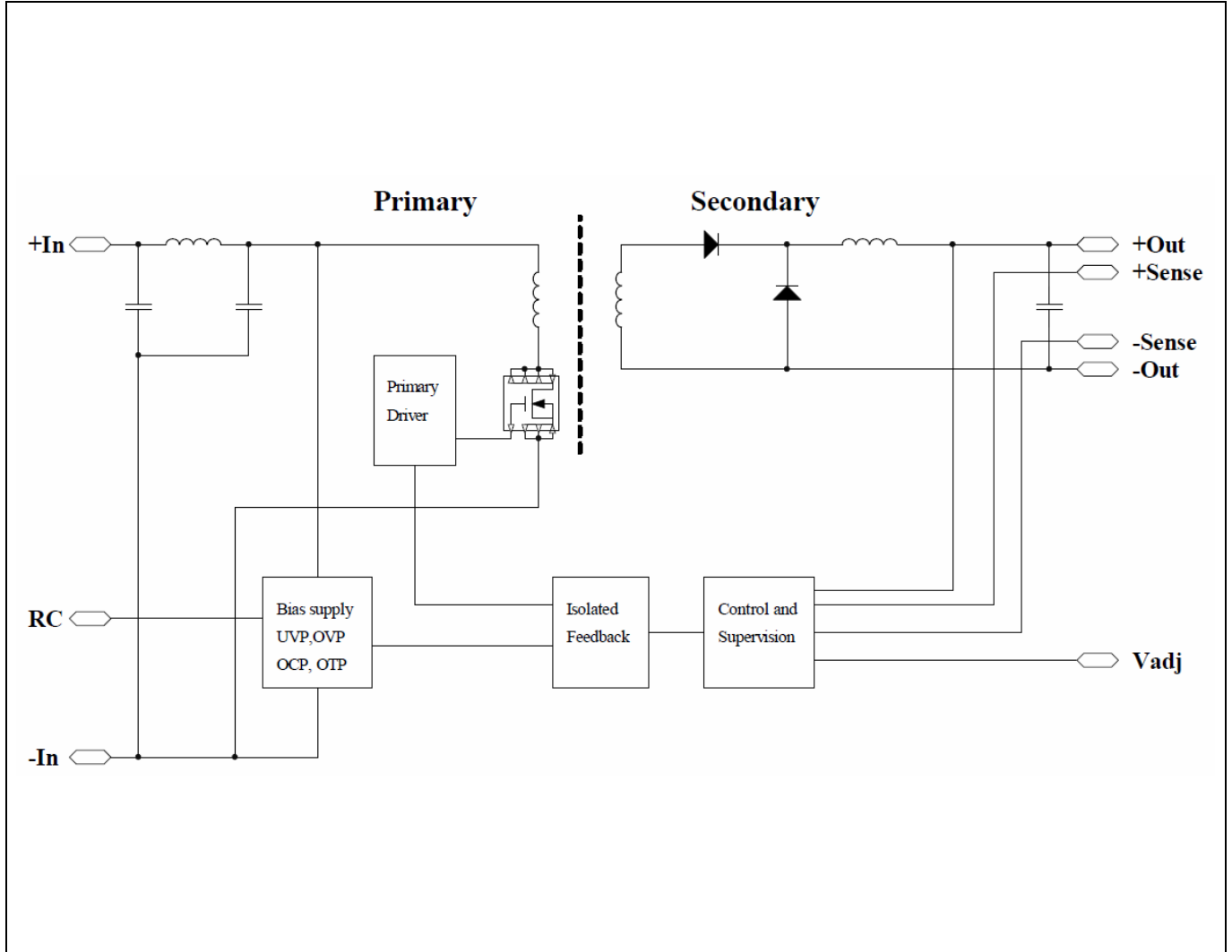

Technical Specification

PKJ 7200 series Direct Converters Input
60-160 V, Output up to 16.8 A / 200 W

28701-BMR 714 Rev B

November 2019

© Flex

Electrical Specification
12 V, 16.8 A / 200 W

PKJ7213PI(P)

$T_{P1} = -40$ to $+110^{\circ}\text{C}$, $V_I = 60$ to 160 V, sense pins connected to output pins unless otherwise specified under Conditions.

Typical values given at: $T_{P1} = +25^{\circ}\text{C}$, $V_I = 110$ V, $I_O = \text{max } I_O$, unless otherwise specified under Conditions.

At least 100uF E-Cap be added in the input terminal for stabilize input voltage source.

Characteristics		Conditions	min	typ	max	Unit
V_I	Input voltage range		60		160	V
V_{Ioff}	Turn-off input voltage	Decreasing input voltage	54	56	58	V
V_{Ion}	Turn-on input voltage	Increasing input voltage	56	58	60	V
C_i	Internal input capacitance			2840		nF
P_O	Output power		0		200	W
η	Efficiency	50% of max I_O , $V_I = 110$ V		89.5		%
		max I_O , $V_I = 110$ V		90.4		
P_d	Power Dissipation	max I_O		21.2		W
P_{ii}	Input idling power	$I_O = 0$ A, $V_I = 110$ V		1		W
f_s	Switching frequency	0-100 % of max I_O		300		kHz

V_{O1}	Output voltage initial setting and accuracy	$T_{P1} = +25^{\circ}\text{C}$, $V_I = 110$ V, $I_O = 16.8$ A	11.88	12	12.12	V
V_O	Output adjust range	See operating information	10.8		13.2	V
	Output voltage tolerance band	0-100% of max I_O	11.88	12	12.12	V
	Idling voltage	$I_O = 0$ A	11.88	12	12.12	V
	Line regulation	max I_O	-60		60	mV
	Load regulation	$V_I = 110$ V, 25-100% of max I_O	-120		120	mV
V_{tr}	Load transient voltage deviation	$V_I = 110$ V, Load step 50-75-50% of max I_O , $di/dt = 100\text{mA}/\mu\text{s}$		± 500		mV
t_{tr}	Load transient recovery time			100	500	μs
t_r	Ramp-up time (from 10-90% of V_{O1})	10-100% of max I_O , $T_{P1} = 25^{\circ}\text{C}$, $V_I = 110$ V		15		ms
t_s	Start-up time (from V_I connection to 90% of V_{O1})			21		ms
t_{RC}	RC start-up time (from V_{RC} connection to 90% of V_{O1})		max I_O		20.5	
RC	Sink current	See operating information	0.5			mA
	Trigger level	Decreasing / Increasing RC-voltage		0.8/2.5		V
t_f	V_I shut-down fall time (from V_I off to 10% of V_O)	max I_O		2		ms
		$I_O = 0$ A		20		s
I_O	Output current		0		16.8	A
I_{lim}	Current limit threshold	$T_{P1} < \text{max } T_{P1}$	20		28.0	A
I_{sc}	Short circuit current	$T_{P1} = 25^{\circ}\text{C}$, see Note 1		0.323		A
C_{out}	Recommended Capacitive Load	$T_{P1} = 25^{\circ}\text{C}$	0		3000	μF
V_{Oac}	Output ripple & noise	See ripple & noise section, V_{O1} , max I_O , see Note 2		60	120	mVp-p
OVP	Over voltage protection	$T_{P1} = +25^{\circ}\text{C}$, $V_I = 110$ V, 0-100% of max I_O	13.8		18	V

Note 1: RMS current at OCP in hic-up mode.

Note 2: Measured by 20MHz bandwidth with a 10uF/25V X7R MLCC and a 22uF/25V POS-CAP

PKJ 7200 series Direct Converters Input
60-160 V, Output up to 16.8 A / 200 W

28701-BMR 714 Rev B November 2019
© Flex

Typical Characteristics
12 V, 16.8 A / 200 W

PKJ7213PI(P)

Efficiency

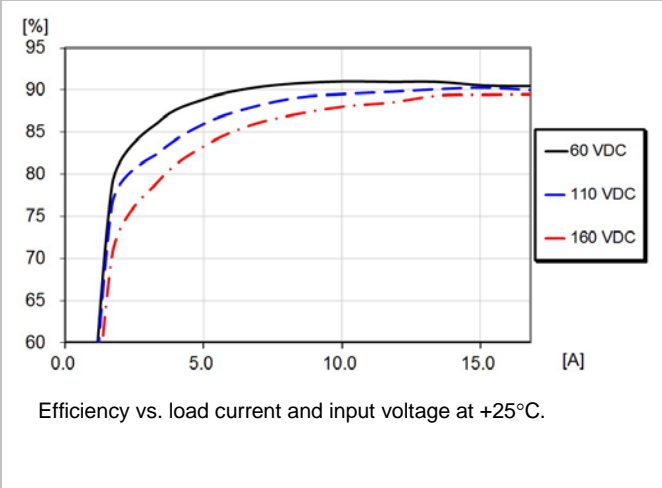

Power Dissipation

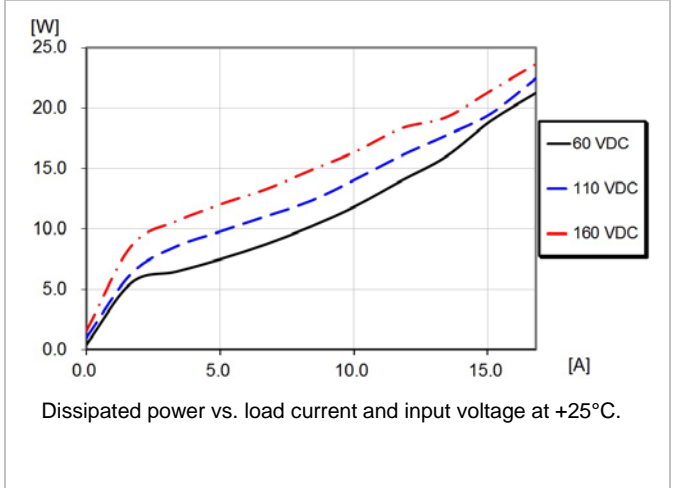

Output Current Derating

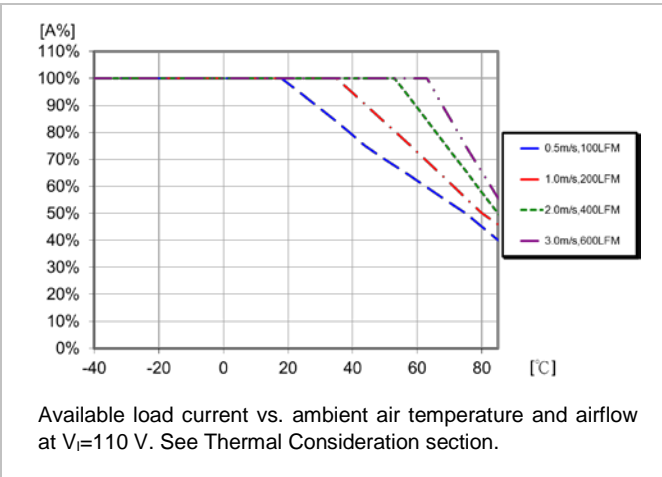

Current Limit Characteristics

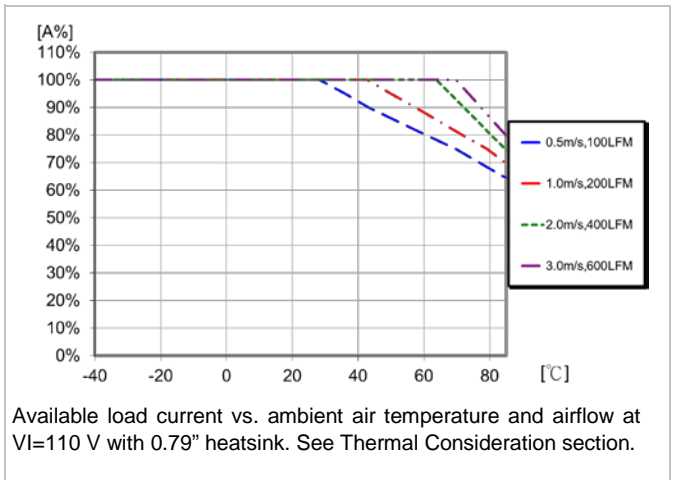
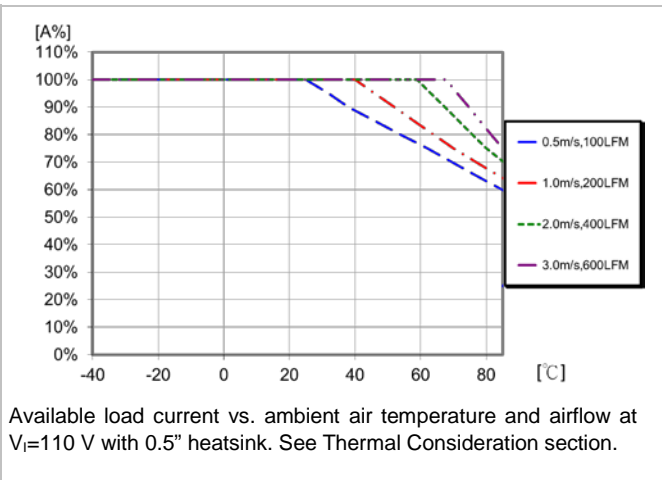
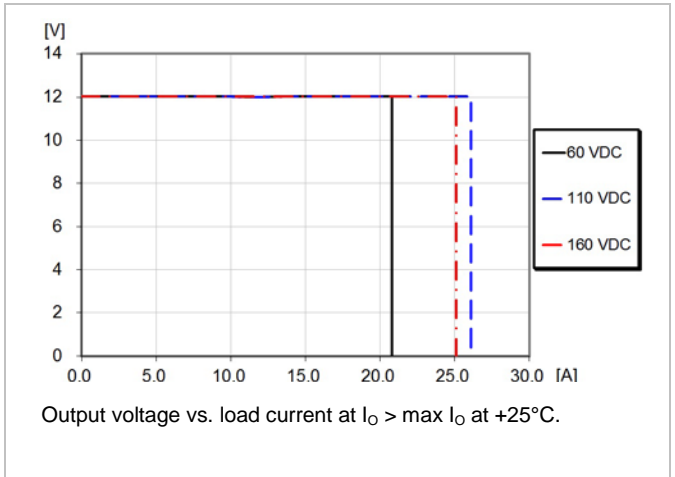

PKJ 7200 series Direct Converters Input
60-160 V, Output up to 16.8 A / 200 W

28701-BMR 714 Rev B

November 2019

© Flex

Typical Characteristics
12 V, 16.8 A / 200 W

PKJ7213PI(P)

Output Current Derating– Cold wall sealed box

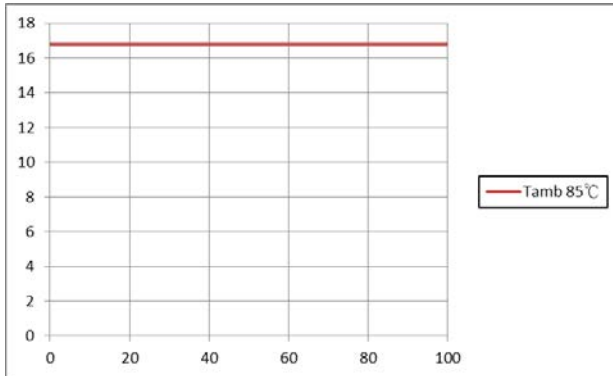

Available load current vs. cold wall temperature. VI = 110 V. See Thermal Consideration section.

PKJ 7200 series Direct Converters Input
60-160 V, Output up to 16.8 A / 200 W

28701-BMR 714 Rev B November 2019
© Flex

Typical Characteristics
12 V, 16.8 A / 200 W

PKJ7213PI(P)

Start-up

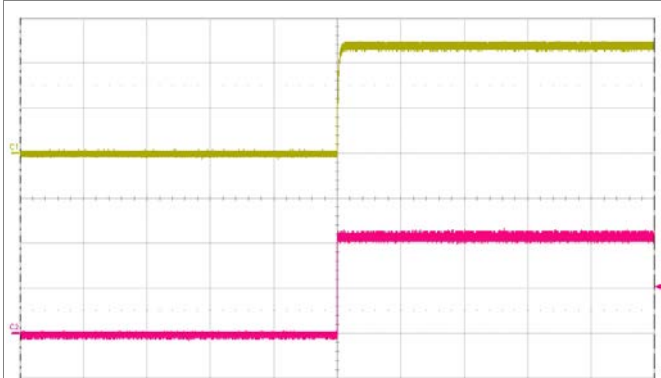

Start-up enabled by connecting V_I at:
 $T_{P1} = +25^{\circ}\text{C}$, $V_I = 110\text{ V}$,
 $I_O = 16.8\text{ A}$ resistive load.
Top trace: output voltage (5V/div.).
Bottom trace: input voltage (50 V/div.).
Time scale: (500 ms/div.).

Shut-down

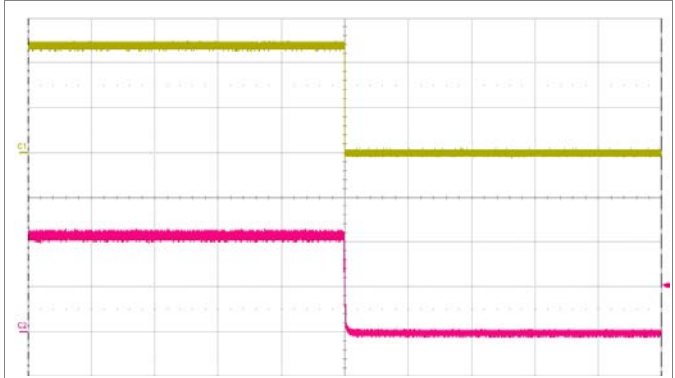

Shut-down enabled by disconnecting V_I at:
 $T_{P1} = +25^{\circ}\text{C}$, $V_I = 110\text{ V}$,
 $I_O = 16.8\text{ A}$ resistive load.
Top trace: output voltage (5 V/div.).
Bottom trace: input voltage (50 V/div.).
Time scale: (500 ms/div.).

Output Ripple & Noise

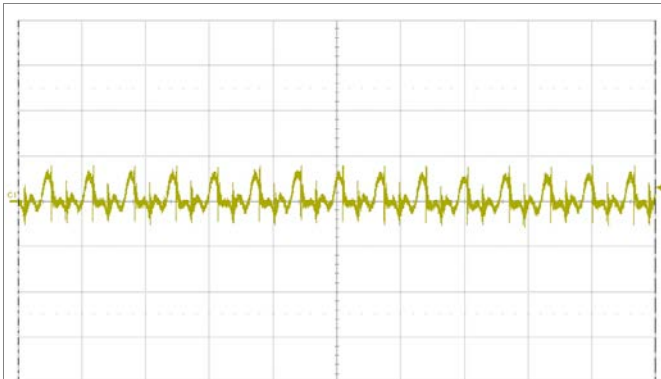

Output voltage ripple at:
 $T_{P1} = +25^{\circ}\text{C}$, $V_I = 110\text{ V}$,
 $I_O = 16.8\text{ A}$ resistive load.
Trace: output voltage (20 mV/div.).
Time scale: (5 μs /div.).
20 MHz bandwidth.

Output Load Transient Response

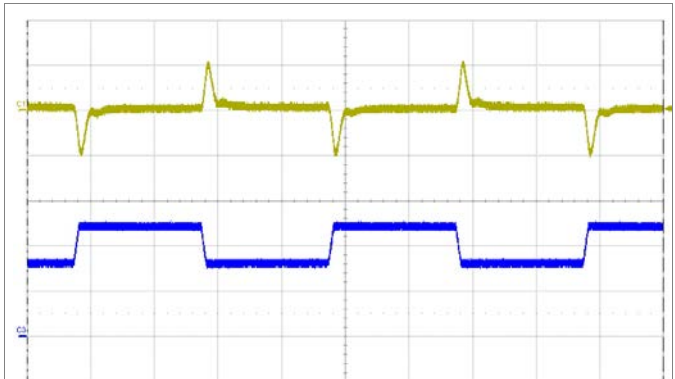

Output voltage response to load current step-
change (8.4-12.6-8.4 A) at:
 $T_{P1} = +25^{\circ}\text{C}$, $V_I = 110\text{ V}$.
Top trace: output voltage (500 mV/div.).
Bottom trace: load current (5 A/div.).
Time scale: (500 μs /div.).

Output Voltage Adjust (TRIM UP/TRIM DOWN)

Output Voltage=12V

The resistor value for an adjusted output voltage is calculated by using the following equations:

Output Voltage Adjust, Increase:

$$R_{ADJ_UP} = \left(\frac{7.246}{\Delta} - 62 \right) k\Omega$$

Output Voltage Adjust, Decrease:

$$R_{ADJ_DOWN} = \left(\frac{9.125}{\Delta} - 78.371 \right) k\Omega$$

Example:

To trim up the 12V model by 8% to 12.96V the required external resistor is:

$$R_{ADJ_UP} = \left(\frac{7.246}{0.08} - 62 \right) = 28.58k\Omega$$

Example:

To trim down the 12V model by 7% to 11.16V the required external resistor is:

$$R_{ADJ_DOWN} = \left(\frac{9.125}{0.07} - 78.371 \right) = 51.99k\Omega$$

Technical Specification

PKJ 7200 series Direct Converters Input
60-160 V, Output up to 16.8 A / 200 W

28701-BMR 714 Rev B

November 2019

© Flex

Electrical Specification
13.8 V, 14.5 A / 200 W

PKJ7217KPI(P)

$T_{P1} = -40$ to $+110^{\circ}\text{C}$, $V_I = 60$ to 160 V, sense pins connected to output pins unless otherwise specified under Conditions.

Typical values given at: $T_{P1} = +25^{\circ}\text{C}$, $V_I = 110$ V, $I_O = \text{max } I_O$, unless otherwise specified under Conditions.

At least 100 μF E-Cap be added in the input terminal for stabilize input voltage source.

At least 330 μF E-Cap be added in the converter output for stabilize output voltage source. External capacitor need to close to the converter.

Characteristics		Conditions	min	typ	max	Unit
V_I	Input voltage range		60		160	V
V_{loff}	Turn-off input voltage	Decreasing input voltage	54	56	58	V
V_{lon}	Turn-on input voltage	Increasing input voltage	56	58	60	V
C_I	Internal input capacitance			3400		nF
P_O	Output power		0		200	W
η	Efficiency	50% of max I_O , $V_I = 110$ V		91.3		%
		max I_O , $V_I = 110$ V		93.1		
P_d	Power Dissipation	max I_O		14.8		W
P_{ii}	Input idling power	$I_O = 0$ A, $V_I = 110$ V		6.8		W
f_s	Switching frequency	0-100 % of max I_O		230		kHz

V_{O_i}	Output voltage initial setting and accuracy	$T_{P1} = +25^{\circ}\text{C}$, $V_I = 110$ V, $I_O = 16.8$ A	13.662	13.8	13.938	V
V_O	Output adjust range	See operating information	12.42		15.18	V
	Output voltage tolerance band	0-100% of max I_O	13.662	13.8	13.938	V
	Idling voltage	$I_O = 0$ A	13.662	13.8	13.938	V
	Line regulation	max I_O	-69		69	mV
	Load regulation	$V_I = 110$ V, 25-100% of max I_O	-138		138	mV
V_{tr}	Load transient voltage deviation	$V_I = 110$ V, Load step 50-75-50% of max I_O , $di/dt = 100\text{mA}/\mu\text{s}$		± 500		mV
t_{tr}	Load transient recovery time			100	500	μs
t_r	Ramp-up time (from 10-90% of V_{O_i})	10-100% of max I_O , $T_{P1} = 25^{\circ}\text{C}$, $V_I = 110$ V		15		ms
t_s	Start-up time (from V_I connection to 90% of V_{O_i})			74		ms
t_{RC}	RC start-up time (from V_{RC} connection to 90% of V_{O_i})	max I_O		15		ms
RC	Sink current	See operating information	0.5			mA
	Trigger level	Decreasing / Increasing RC-voltage		0.8/2.5		V
t_f	V_I shut-down fall time (from V_I off to 10% of V_O)	max I_O		16		ms
		$I_O = 0$ A		204		ms
I_O	Output current		0		14.5	A
I_{lim}	Current limit threshold	$T_{P1} < \text{max } T_{P1}$	17		21	A
I_{sc}	Short circuit current	$T_{P1} = 25^{\circ}\text{C}$, see Note 1		0.101		A
C_{out}	Recommended Capacitive Load	$T_{P1} = 25^{\circ}\text{C}$	0		3000	μF
V_{Oac}	Output ripple & noise	See ripple & noise section, V_{O_i} , max I_O , see Note 2		80	150	mVp-p
OVP	Over voltage protection	$T_{P1} = +25^{\circ}\text{C}$, $V_I = 110$ V, 0-100% of max I_O	15.3		18	V

Note 1: RMS current at OCP in hic-up mode.

Note 2: Measured by 20MHz bandwidth with a 10 $\mu\text{F}/25\text{V}$ X7R MLCC and a 22 $\mu\text{F}/25\text{V}$ POS-CAP

Technical Specification

PKJ 7200 series Direct Converters Input
60-160 V, Output up to 16.8 A / 200 W

28701-BMR 714 Rev B November 2019
© Flex

Typical Characteristics
13.8 V, 14.5 A / 200 W

PKJ7217KPI(P)

Efficiency

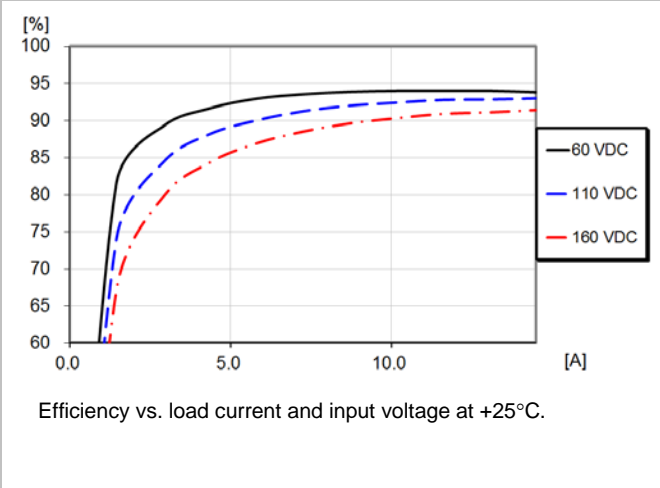

Power Dissipation

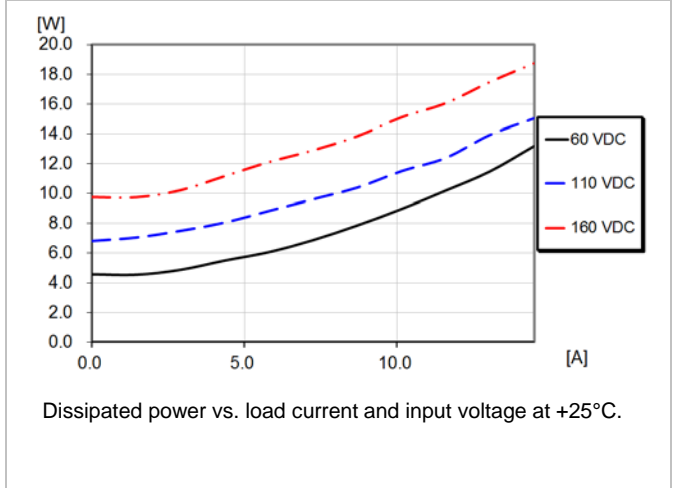

Output Current Derating

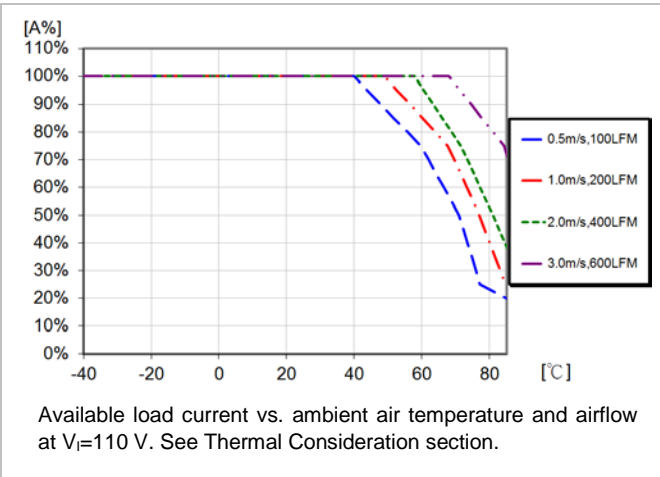

Current Limit Characteristics

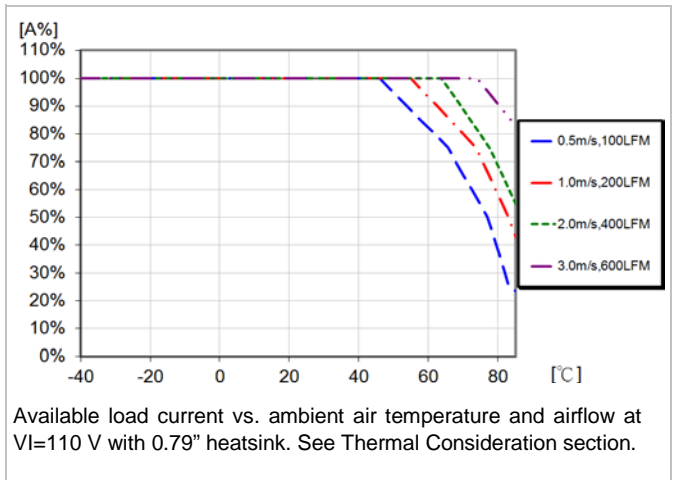
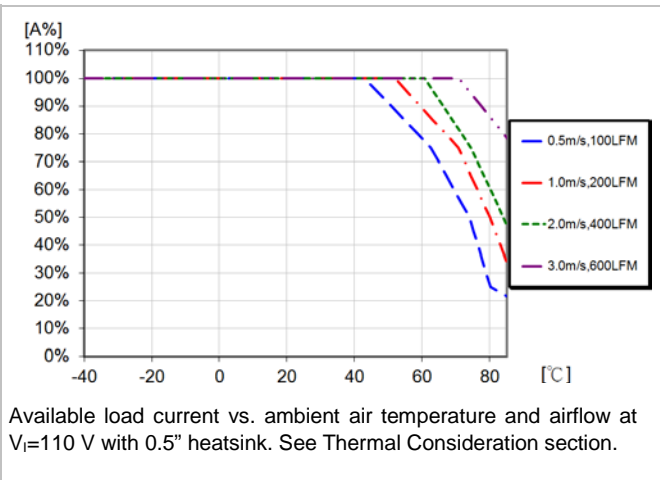
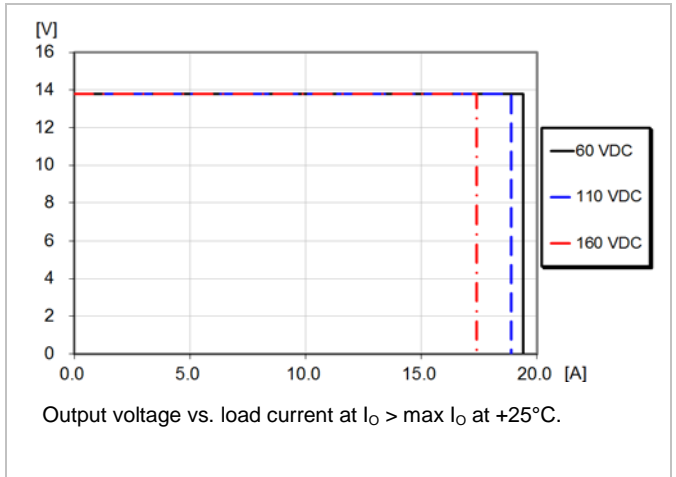

Technical Specification

PKJ 7200 series Direct Converters Input
60-160 V, Output up to 16.8 A / 200 W

28701-BMR 714 Rev B November 2019

© Flex

Typical Characteristics
13.8 V, 14.5 A / 200 W

PKJ7217KPI(P)

Output Current Derating– Cold wall sealed box

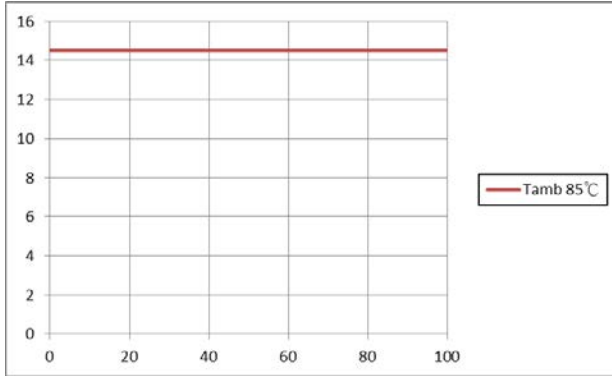

Available load current vs. cold wall temperature. VI = 110 V. See Thermal Consideration section.

Technical Specification

PKJ 7200 series Direct Converters Input
60-160 V, Output up to 16.8 A / 200 W

28701-BMR 714 Rev B November 2019
© Flex

Typical Characteristics
13.8 V, 14.5 A / 200 W

PKJ7217KPI(P)

Start-up

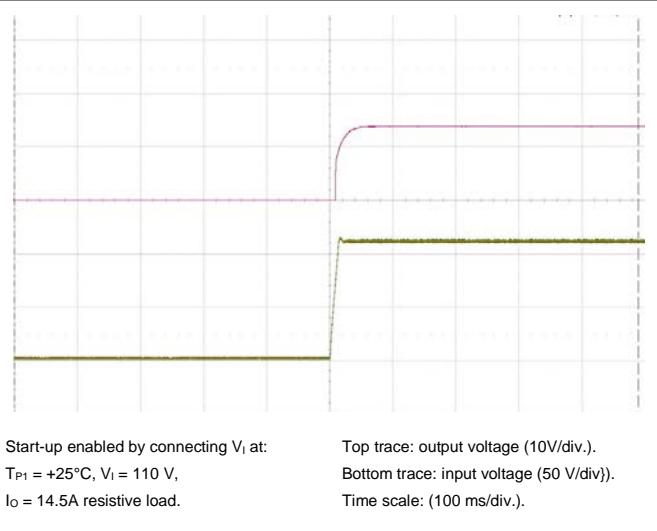

Shut-down

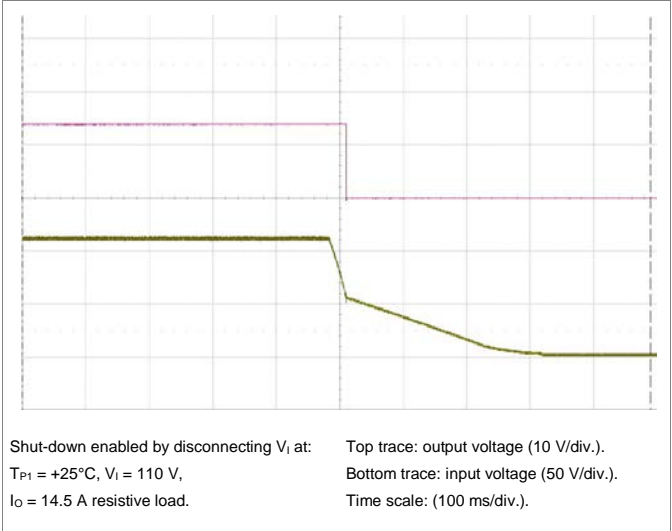

Output Ripple & Noise

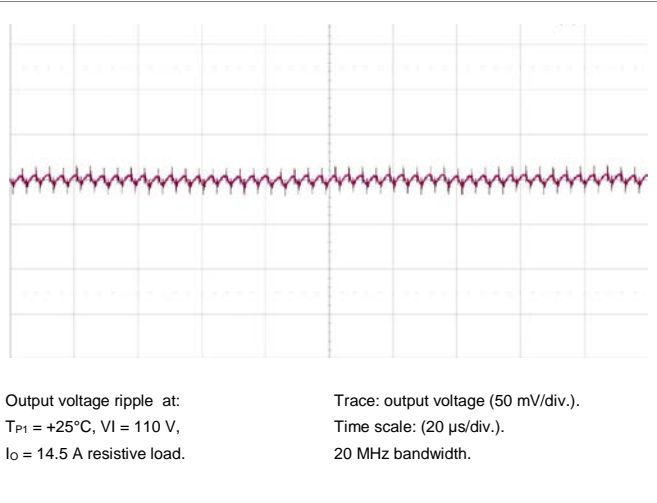

Output Load Transient Response

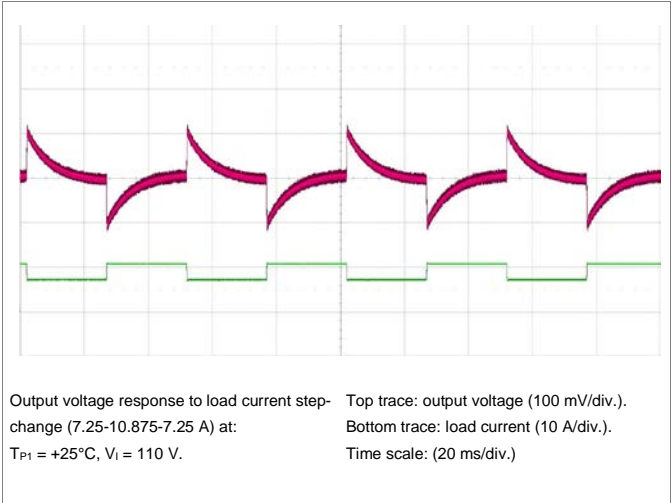

Output Voltage Adjust (TRIM UP/TRIM DOWN)

Output Voltage=13.8V

The resistor value for an adjusted output voltage is calculated by using the following equations:

Output Voltage Adjust, Increase:

$$R_{ADJ_UP} = \left(\frac{8.403}{\Delta} - 56 \right) k\Omega$$

Output Voltage Adjust, Decrease:

$$R_{ADJ_DOWN} = \left(\frac{8.215}{\Delta} - 72.619 \right) k\Omega$$

Example:

To trim up the 13.8V model by 8% to 14.9V the required external resistor is:

$$R_{ADJ_UP} = \left(\frac{8.403}{0.08} - 56 \right) = 49.03k\Omega$$

Example:

To trim down the 13.8V model by 7% to 12.83V the required external resistor is:

$$R_{ADJ_DOWN} = \left(\frac{8.215}{0.07} - 72.619 \right) = 44.73k\Omega$$

Technical Specification

PKJ 7200 series Direct Converters Input
60-160 V, Output up to 16.8 A / 200 W

28701-BMR 714 Rev B

November 2019

© Flex

Electrical Specification
15 V, 13.5 A / 200 W

PKJ7215PI(P)

$T_{P1} = -40$ to $+110^{\circ}\text{C}$, $V_I = 60$ to 160 V, sense pins connected to output pins unless otherwise specified under Conditions.

Typical values given at: $T_{P1} = +25^{\circ}\text{C}$, $V_I = 110$ V, max I_O , unless otherwise specified under Conditions.

At least 100 μF E-Cap be added in the input terminal for stabilize input voltage source.

Characteristics		Conditions	min	typ	max	Unit
V_I	Input voltage range		60		160	V
V_{loff}	Turn-off input voltage	Decreasing input voltage	54	56	58	V
V_{lon}	Turn-on input voltage	Increasing input voltage	56	58	60	V
C_I	Internal input capacitance			2840		nF
P_O	Output power		0		200	W
η	Efficiency	50% of max I_O , $V_I = 110$ V		89.5		%
		max I_O , $V_I = 110$ V		90.1		
P_d	Power Dissipation	max I_O		21.9		W
P_{li}	Input idling power	$I_O = 0$ A, $V_I = 110$ V		1		W
f_s	Switching frequency	0-100 % of max I_O		300		kHz

V_{oi}	Output voltage initial setting and accuracy	$T_{P1} = +25^{\circ}\text{C}$, $V_I = 110$ V, $I_O = 13.5$ A	14.85	15	15.15	V
V_O	Output adjust range	See operating information	13.5		16.5	V
	Output voltage tolerance band	0-100% of max I_O	14.85	15	15.15	V
	Idling voltage	$I_O = 0$ A	14.85	15	15.15	V
	Line regulation	max I_O	-75		75	mV
	Load regulation	$V_I = 110$ V, 25-100% of max I_O	-150		150	mV
V_{tr}	Load transient voltage deviation	$V_I = 110$ V, Load step 50-75-50% of max I_O , $di/dt = 100\text{mA}/\mu\text{s}$		± 500		mV
t_{tr}	Load transient recovery time			200	500	μs
t_r	Ramp-up time (from 10-90% of V_{oi})	10-100% of max I_O , $T_{P1} = 25^{\circ}\text{C}$, $V_I = 110$ V		13.5		ms
t_s	Start-up time (from V_I connection to 90% of V_{oi})			15		ms
t_{RC}	RC start-up time (from V_{RC} connection to 90% of V_{oi})	max I_O		12		ms
RC	Sink current	See operating information	0.5			mA
	Trigger level	Decreasing / Increasing RC-voltage		0.8/2.5		V
t_f	V_I shut-down fall time (from V_I off to 10% of V_O)	max I_O		2		ms
		$I_O = 0$ A		20		s
I_O	Output current		0		13.5	A
I_{lim}	Current limit threshold	$T_{P1} < \text{max } T_{P1}$	15.5		20.5	A
I_{sc}	Short circuit current	$T_{P1} = 25^{\circ}\text{C}$, see Note 1		0.307		A
C_{out}	Recommended Capacitive Load	$T_{P1} = 25^{\circ}\text{C}$	0		3000	μF
V_{Oac}	Output ripple & noise	See ripple & noise section, V_{oi} , max I_O , see Note 2		60	120	mVp-p
OVP	Over voltage protection	$T_{P1} = +25^{\circ}\text{C}$, $V_I = 110$ V, 0-100% of max I_O	17.25		22.5	V

Note 1: RMS current at OCP in hic-up mode.

Note 2: Measured by 20MHz bandwidth with a 10 $\mu\text{F}/25\text{V}$ X7R MLCC and a 22 $\mu\text{F}/25\text{V}$ POS-CAP

PKJ 7200 series Direct Converters Input
60-160 V, Output up to 16.8 A / 200 W

28701-BMR 714 Rev B

November 2019

© Flex

Typical Characteristics
15 V, 13.5 A / 200 W

PKJ7215PI(P)

Efficiency

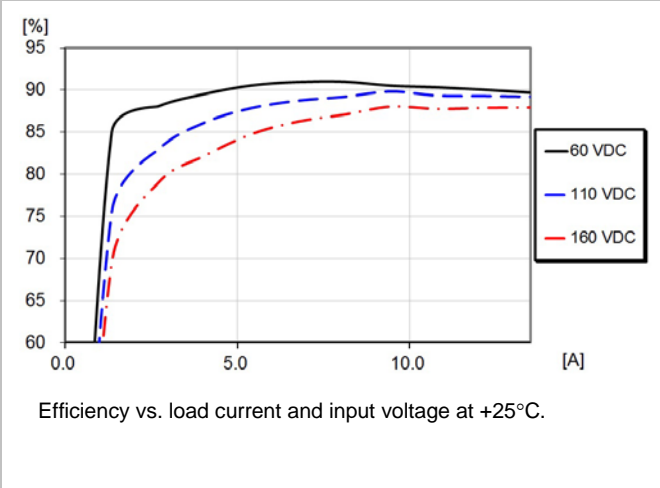

Power Dissipation

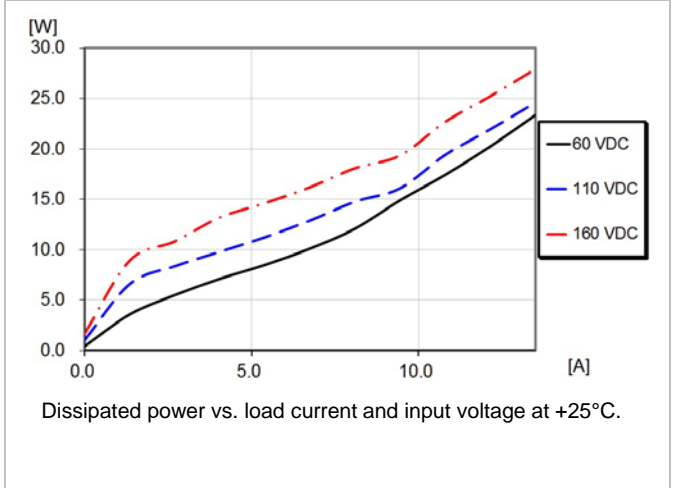

Output Current Derating

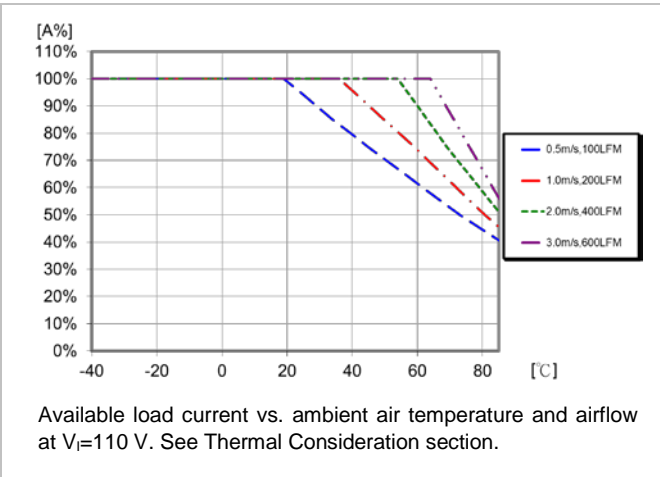

Current Limit Characteristics

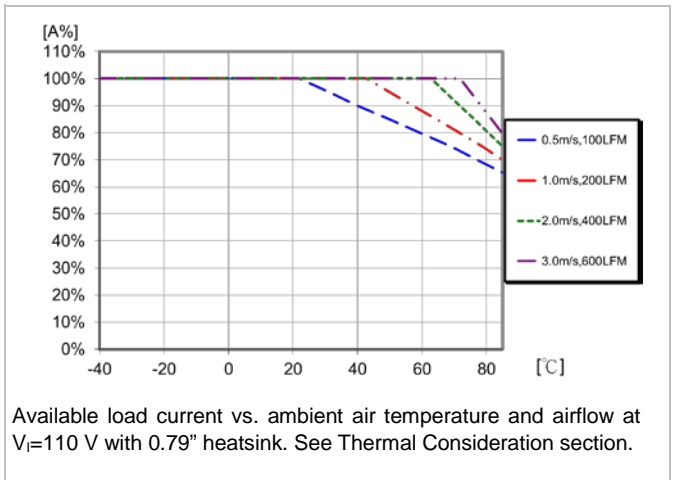
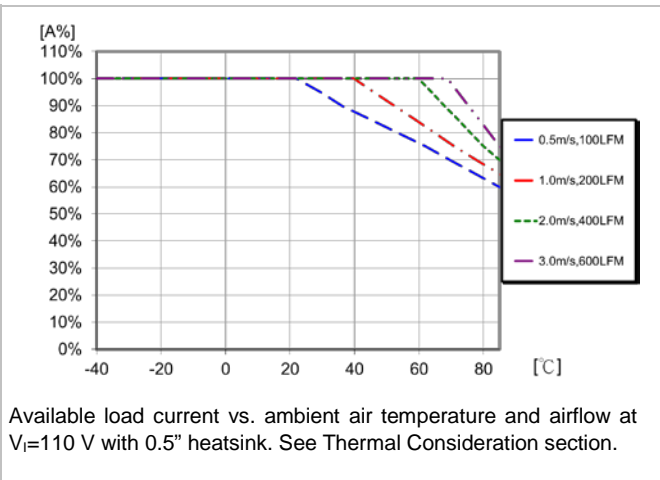
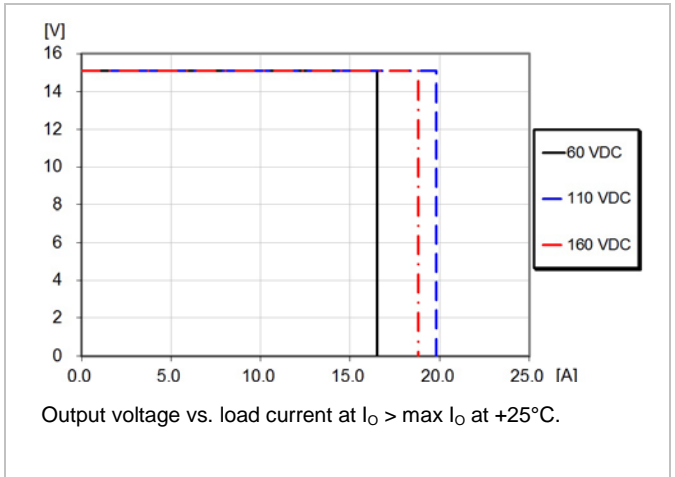

Technical Specification

PKJ 7200 series Direct Converters Input
60-160 V, Output up to 16.8 A / 200 W

28701-BMR 714 Rev B

November 2019

© Flex

Typical Characteristics
15 V, 13.5 A / 200 W

PKJ7215PI(P)

Output Current Derating– Cold wall sealed box

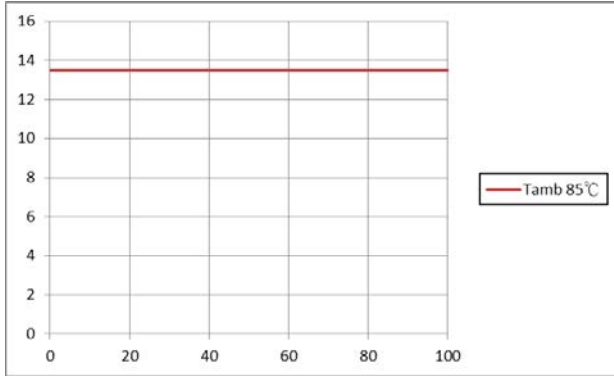

Available load current vs. cold wall temperature. VI = 110 V. See Thermal Consideration section.

PKJ 7200 series Direct Converters Input
60-160 V, Output up to 16.8 A / 200 W

28701-BMR 714 Rev B November 2019
© Flex

Typical Characteristics
15 V, 13.5 A / 200 W

PKJ7215PI(P)

Start-up

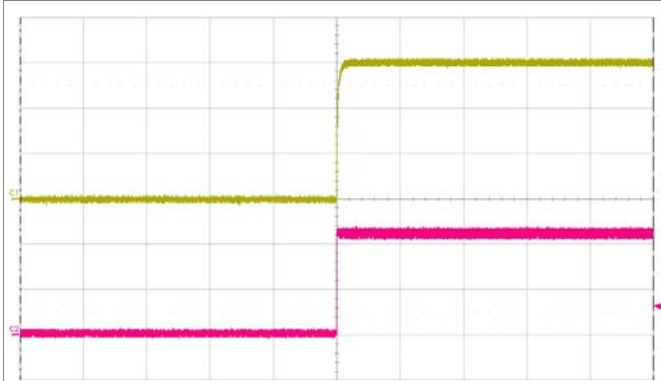

Start-up enabled by connecting V_I at:
 $T_{P1} = +25^{\circ}\text{C}$, $V_I = 110\text{ V}$,
 $I_O = 13.5\text{ A}$ resistive load.
Top trace: output voltage (5 V/div.).
Bottom trace: input voltage (50 V/div.).
Time scale: (500 ms/div.).

Shut-down

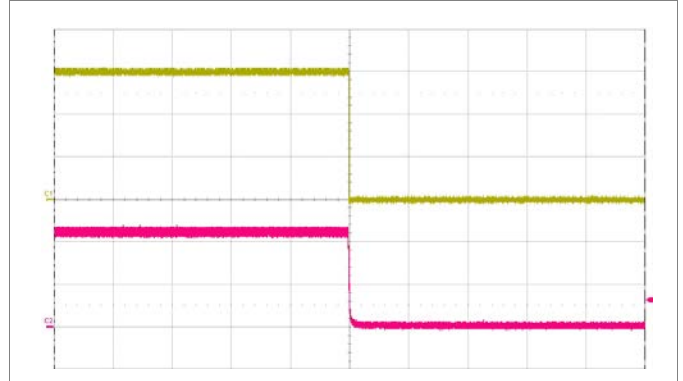

Shut-down enabled by disconnecting V_I at:
 $T_{P1} = +25^{\circ}\text{C}$, $V_I = 110\text{ V}$,
 $I_O = 13.5\text{ A}$ resistive load.
Top trace: output voltage (5 V/div.).
Bottom trace: input voltage (50 V/div.).
Time scale: (500 ms/div.).

Output Ripple & Noise

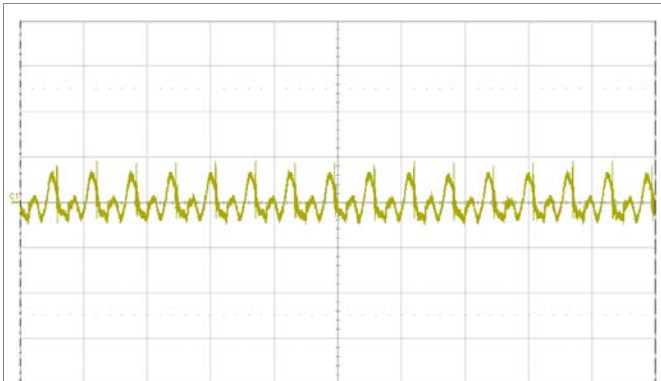

Output voltage ripple at:
 $T_{P1} = +25^{\circ}\text{C}$, $V_I = 110\text{ V}$,
 $I_O = 13.5\text{ A}$ resistive load.
Trace: output voltage (20 mV/div.).
Time scale: (5 μs /div.).
20 MHz bandwidth.

Output Load Transient Response

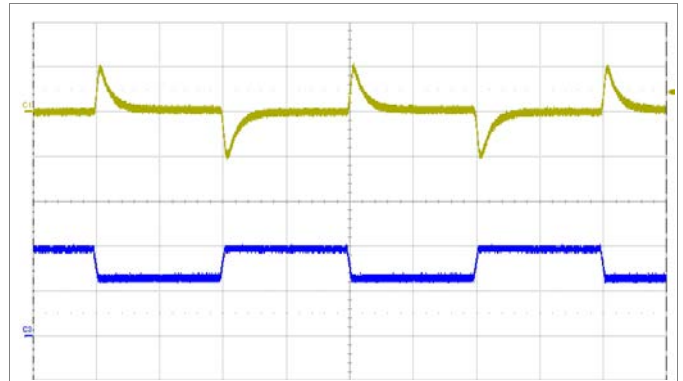

Output voltage response to load current step-change (6.75-10.125-6.75 A) at:
 $T_{P1} = +25^{\circ}\text{C}$, $V_I = 110\text{ V}$.
Top trace: output voltage (500 mV/div.).
Bottom trace: load current (5 A/div.).
Time scale: (500 μs /div.).

Output Voltage Adjust (TRIM UP/TRIM DOWN)

Output Voltage=15V

The resistor value for an adjusted output voltage is calculated by using the following equations:

Output Voltage Adjust, Increase:

$$R_{ADJ_UP} = \left(\frac{9.186}{\Delta} - 68 \right) k\Omega$$

Output Voltage Adjust, Decrease:

$$R_{ADJ_DOWN} = \left(\frac{9.5738}{\Delta} - 86.76 \right) k\Omega$$

Example:

To trim up the 15V model by 8% to 16.2V the required external resistor is:

$$R_{ADJ_UP} = \left(\frac{9.186}{0.08} - 68 \right) = 46.83k\Omega$$

Example:

To trim down the 15V model by 7% to 13.95V the required external resistor is:

$$R_{ADJ_DOWN} = \left(\frac{9.5738}{0.07} - 86.76 \right) = 50k\Omega$$

Technical Specification

PKJ 7200 series Direct Converters Input
60-160 V, Output up to 16.8 A / 200 W

28701-BMR 714 Rev B

November 2019

© Flex

Electrical Specification
24 V, 8.4 A / 200 W

PKJ7216ZPI(P)

$T_{P1} = -40$ to $+110^{\circ}\text{C}$, $V_I = 60$ to 160 V, sense pins connected to output pins unless otherwise specified under Conditions.

Typical values given at: $T_{P1} = +25^{\circ}\text{C}$, $V_I = 110$ V, $I_O = \text{max } I_O$, unless otherwise specified under Conditions.

At least 100 μF E-Cap be added in the input terminal for stabilize input voltage source.

Characteristics		Conditions	min	typ	max	Unit
V_I	Input voltage range		60		160	V
V_{Ioff}	Turn-off input voltage	Decreasing input voltage	54	56	58	V
V_{Ion}	Turn-on input voltage	Increasing input voltage	56	58	60	V
C_i	Internal input capacitance			2840		nF
P_O	Output power		0		200	W
η	Efficiency	50% of max I_O , $V_I = 110$ V		90.5		%
		max I_O , $V_I = 110$ V		91.3		
P_d	Power Dissipation	max I_O		19.0		W
P_{ii}	Input idling power	$I_O = 0$ A, $V_I = 110$ V		1		W
f_s	Switching frequency	0-100 % of max I_O		300		kHz

V_{Oi}	Output voltage initial setting and accuracy	$T_{P1} = +25^{\circ}\text{C}$, $V_I = 110$ V, $I_O = 8.4$ A	23.76	24	24.24	V
V_O	Output adjust range	See operating information	21.6		26.4	V
	Output voltage tolerance band	0-100% of max I_O	23.76	24	24.24	V
	Idling voltage	$I_O = 0$ A	23.76	24	24.24	V
	Line regulation	max I_O	-120		120	mV
	Load regulation	$V_I = 110$ V, 25-100% of max I_O	-240		240	mV
V_{tr}	Load transient voltage deviation	$V_I = 110$ V, Load step 50-75-50% of max I_O , $di/dt = 100\text{mA}/\mu\text{s}$		± 600		mV
t_{tr}	Load transient recovery time			200	500	μs
t_r	Ramp-up time (from 10-90% of V_{Oi})	10-100% of max I_O , $T_{P1} = 25^{\circ}\text{C}$, $V_I = 110$ V		20		ms
t_s	Start-up time (from V_I connection to 90% of V_{Oi})			22		ms
t_{RC}	RC start-up time (from V_{RC} connection to 90% of V_{Oi})		max I_O		15	
RC	Sink current	See operating information	0.5			mA
	Trigger level	Decreasing / Increasing RC-voltage		0.8/2.5		V
t_f	V_I shut-down fall time (from V_I off to 10% of V_O)	max I_O		2		ms
		$I_O = 0$ A		14		s
I_O	Output current		0		8.4	A
I_{lim}	Current limit threshold	$T_{P1} < \text{max } T_{P1}$	10.2		13.8	A
I_{sc}	Short circuit current	$T_{P1} = 25^{\circ}\text{C}$, see Note 1		0.292		A
C_{out}	Recommended Capacitive Load	$T_{P1} = 25^{\circ}\text{C}$	0		3000	μF
V_{Oac}	Output ripple & noise	See ripple & noise section, V_{Oi} , max I_O , see Note 2		100	150	mVp-p
OVP	Over voltage protection	$T_{P1} = +25^{\circ}\text{C}$, $V_I = 110$ V, 0-100% of max I_O	27.6		36	V

Note 1: RMS current at OCP in hic-up mode.

Note 2: Measured by 20MHz bandwidth with 10 μF +0.1 μF X7R MLCC

PKJ 7200 series Direct Converters Input
60-160 V, Output up to 16.8 A / 200 W

28701-BMR 714 Rev B

November 2019

© Flex

Typical Characteristics
24 V, 8.4 A / 200 W

PKJ7216ZPI(P)

Efficiency

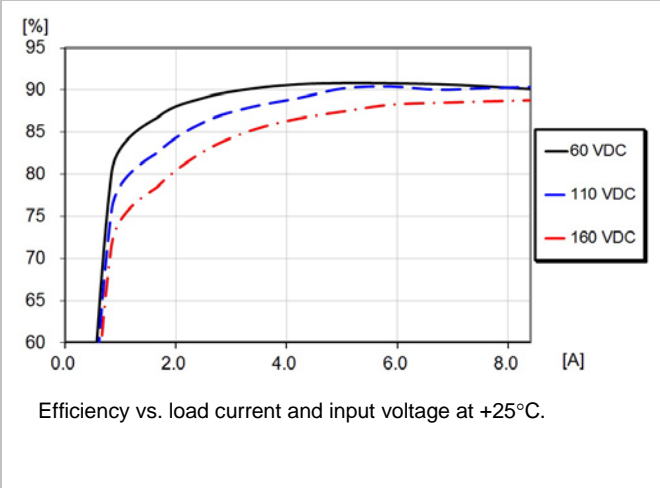

Power Dissipation

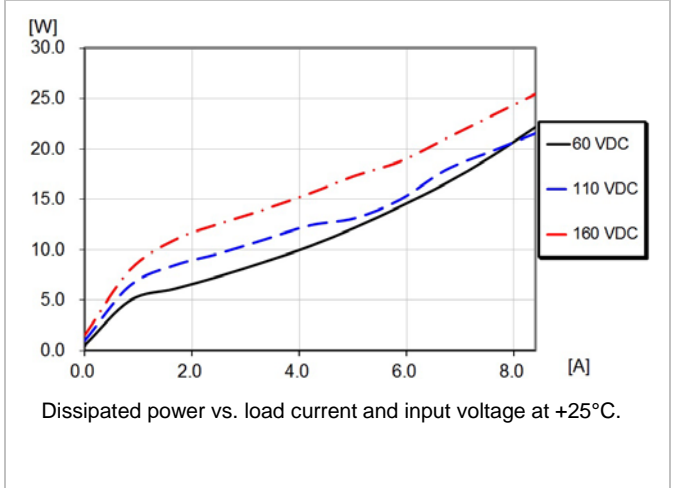

Output Current Derating

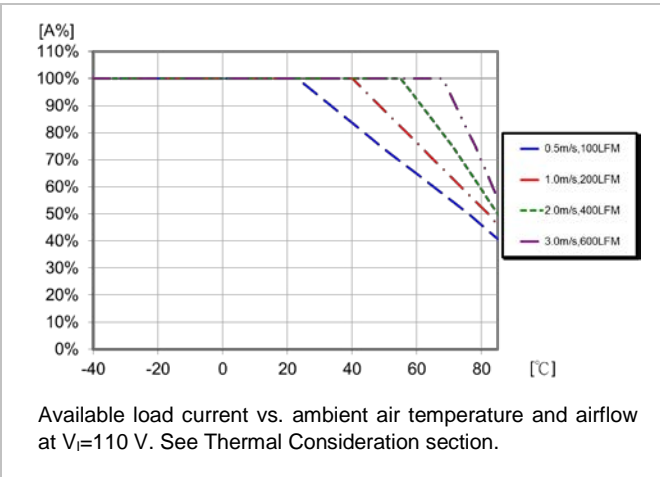

Current Limit Characteristics

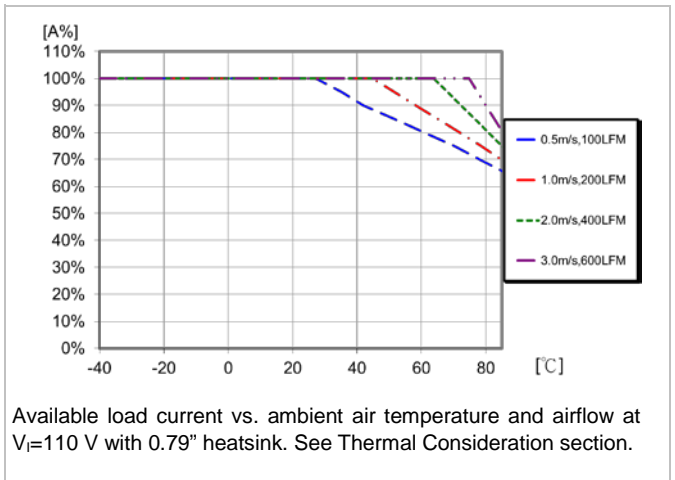
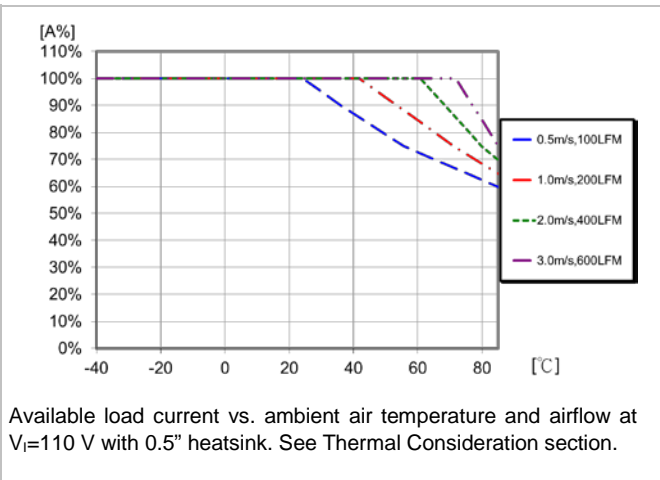
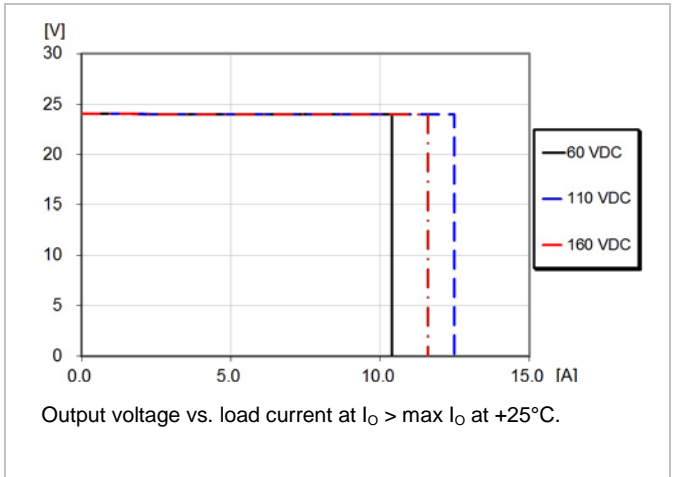

Technical Specification

PKJ 7200 series Direct Converters Input
60-160 V, Output up to 16.8 A / 200 W

28701-BMR 714 Rev B

November 2019

© Flex

Typical Characteristics
24 V, 8.4 A / 200 W

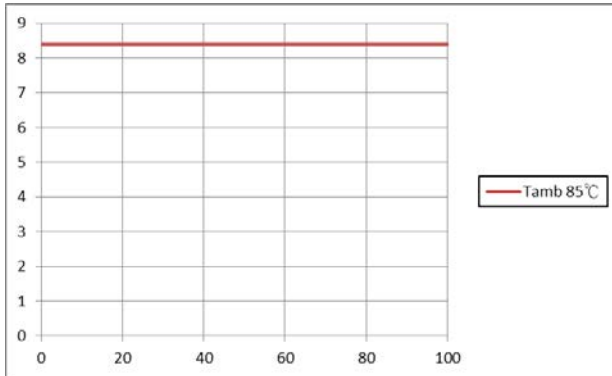
PKJ7216ZPI(P)**Output Current Derating– Cold wall sealed box**

Available load current vs. cold wall temperature. $V_I = 110$ V. See Thermal Consideration section.

PKJ 7200 series Direct Converters Input
60-160 V, Output up to 16.8 A / 200 W

28701-BMR 714 Rev B November 2019
© Flex

Typical Characteristics
24 V, 8.4 A / 200 W

PKJ7216ZPI(P)

Start-up

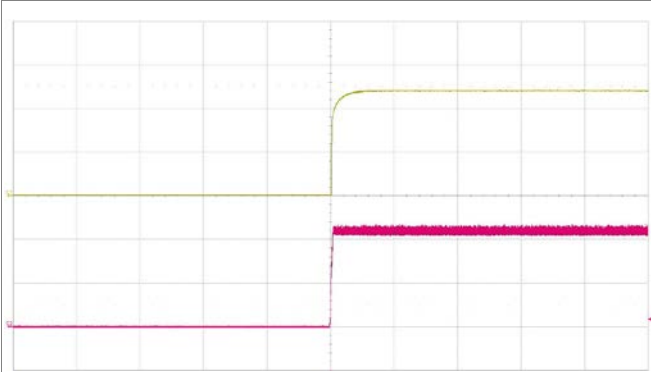

Start-up enabled by connecting V_I at:
 $T_{P1} = +25^{\circ}\text{C}$, $V_I = 110\text{ V}$,
 $I_O = 8.4\text{ A}$ resistive load.
Top trace: output voltage (10 V/div.).
Bottom trace: input voltage (50 V/div.).
Time scale: (200 ms/div.).

Shut-down

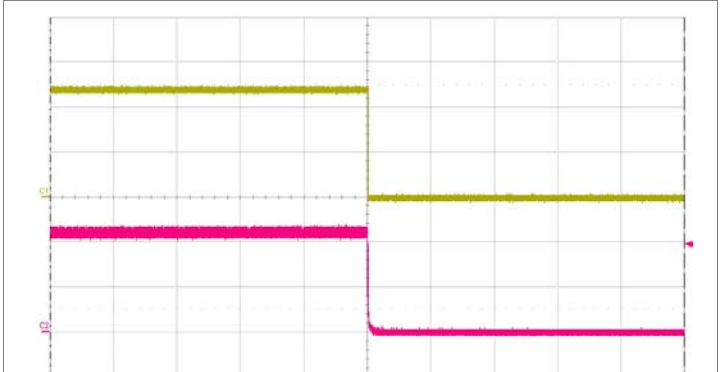

Shut-down enabled by disconnecting V_I at:
 $T_{P1} = +25^{\circ}\text{C}$, $V_I = 110\text{ V}$,
 $I_O = 8.4\text{ A}$ resistive load.
Top trace: output voltage (10 V/div.).
Bottom trace: input voltage (50 V/div.).
Time scale: (200 ms/div.).

Output Ripple & Noise



Output voltage ripple at:
 $T_{P1} = +25^{\circ}\text{C}$, $V_I = 110\text{ V}$,
 $I_O = 8.4\text{ A}$ resistive load.
Trace: output voltage (50 mV/div.).
Time scale: (5 μs /div.).
20 MHz bandwidth.

Output Load Transient Response

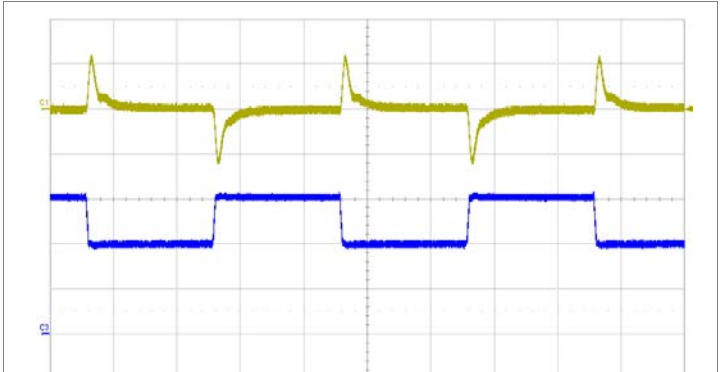

Output voltage response to load current step-change (6.3-4.2-6.3 A) at:
 $T_{P1} = +25^{\circ}\text{C}$, $V_I = 110\text{ V}$.
Top trace: output voltage (500mV/div.).
Bottom trace: load current (2 A/div.).
Time scale: (500 μs /div.).

Output Voltage Adjust (TRIM UP/TRIM DOWN)

Output Voltage=24V

The resistor value for an adjusted output voltage is calculated by using the following equations:

Output Voltage Adjust, Increase:

$$R_{ADJ_UP} = \left(\frac{14.6061}{\Delta} - 120 \right) k\Omega$$

Output Voltage Adjust, Decrease:

$$R_{ADJ_DOWN} = \left(\frac{17.2133}{\Delta} - 151.819 \right) k\Omega$$

Example:

To trim up the 24V model by 8% to 25.92V the required external resistor is:

$$R_{ADJ_UP} = \left(\frac{14.6061}{0.08} - 120 \right) = 62.58k\Omega$$

Example:

To trim down the 24V model by 7% to 22.32V the required external resistor is:

$$R_{ADJ_DOWN} = \left(\frac{17.2133}{0.07} - 151.819 \right) = 94.08k\Omega$$

Technical Specification

PKJ 7200 series Direct Converters Input
60-160 V, Output up to 16.8 A / 200 W

28701-BMR 714 Rev B November 2019

© Flex

Electrical Specification
48 V, 4.2 A / 200 W

PKJ7216JPI(P)

$T_{P1} = -40$ to $+110^{\circ}\text{C}$, $V_I = 60$ to 160 V, sense pins connected to output pins unless otherwise specified under Conditions.

Typical values given at: $T_{P1} = +25^{\circ}\text{C}$, $V_I = 110$ V, $I_O = \text{max } I_O$, unless otherwise specified under Conditions.

At least 100 μF E-Cap be added in the input terminal for stabilize input voltage source.

Characteristics		Conditions	min	typ	max	Unit
V_I	Input voltage range		60		160	V
V_{Ioff}	Turn-off input voltage	Decreasing input voltage	54	56	58	V
V_{Ion}	Turn-on input voltage	Increasing input voltage	56	58	60	V
C_i	Internal input capacitance			2840		nF
P_O	Output power		0		200	W
η	Efficiency	50% of max I_O , $V_I = 110$ V		91.5		%
		max I_O , $V_I = 110$ V		92.5		
P_d	Power Dissipation	max I_O		16.2		W
P_{ii}	Input idling power	$I_O = 0$ A, $V_I = 110$ V		1		W
f_s	Switching frequency	0-100 % of max I_O		300		kHz

V_{Oi}	Output voltage initial setting and accuracy	$T_{P1} = +25^{\circ}\text{C}$, $V_I = 110$ V, $I_O = 4.2$ A	47.52	48	48.48	V
V_O	Output adjust range	See operating information	43.2		52.8	V
	Output voltage tolerance band	0-100% of max I_O	47.52	48	48.48	V
	Idling voltage	$I_O = 0$ A	47.52	48	48.48	V
	Line regulation	max I_O	-240		240	mV
	Load regulation	$V_I = 110$ V, 25-100% of max I_O	-480		480	mV
V_{tr}	Load transient voltage deviation	$V_I = 110$ V, Load step 50-75-50% of max I_O , $di/dt = 100\text{mA}/\mu\text{s}$		± 800		mV
t_{tr}	Load transient recovery time			250	500	μs
t_r	Ramp-up time (from 10-90% of V_{Oi})	10-100% of max I_O , $T_{P1} = 25^{\circ}\text{C}$, $V_I = 110$ V		11		ms
t_s	Start-up time (from V_I connection to 90% of V_{Oi})			14		ms
t_{RC}	RC start-up time (from V_{RC} connection to 90% of V_{Oi})		max I_O		10	
RC	Sink current	See operating information	0.5			mA
	Trigger level	Decreasing / Increasing RC-voltage		0.8/2.5		V
t_f	V_I shut-down fall time (from V_I off to 10% of V_O)	max I_O		2.5		ms
		$I_O = 0$ A		5		s
I_O	Output current		0		4.2	A
I_{lim}	Current limit threshold	$T_{P1} < \text{max } T_{P1}$	5.1		8.0	A
I_{sc}	Short circuit current	$T_{P1} = 25^{\circ}\text{C}$, see Note 1		0.301		A
C_{out}	Recommended Capacitive Load	$T_{P1} = 25^{\circ}\text{C}$	0		3000	μF
V_{Oac}	Output ripple & noise	See ripple & noise section, V_{Oi} , max I_O , see Note 2		100	200	mVp-p
OVP	Over voltage protection	$T_{P1} = +25^{\circ}\text{C}$, $V_I = 110$ V, 0-100% of max I_O	55.2		72	V

Note 1: RMS current at OCP in hic-up mode.

Note 2: Measured by 20MHz bandwidth with 10 μF +0.1 μF X7R MLCC

Technical Specification

PKJ 7200 series Direct Converters Input
60-160 V, Output up to 16.8 A / 200 W

28701-BMR 714 Rev B November 2019
© Flex

Typical Characteristics
48 V, 4.2 A / 200 W

PKJ7216JPI(P)

Efficiency

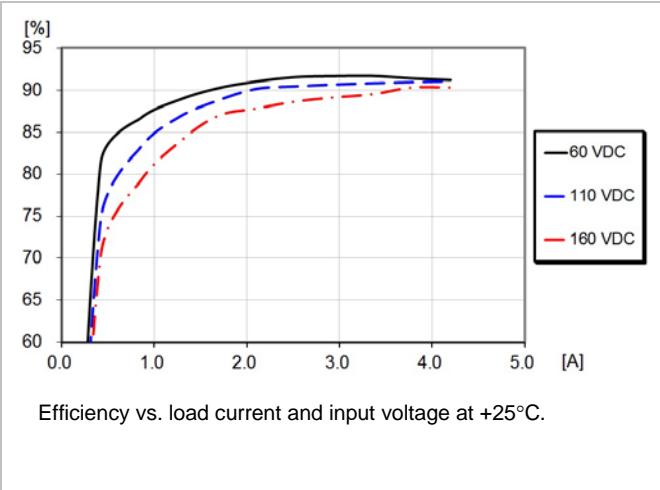

Power Dissipation

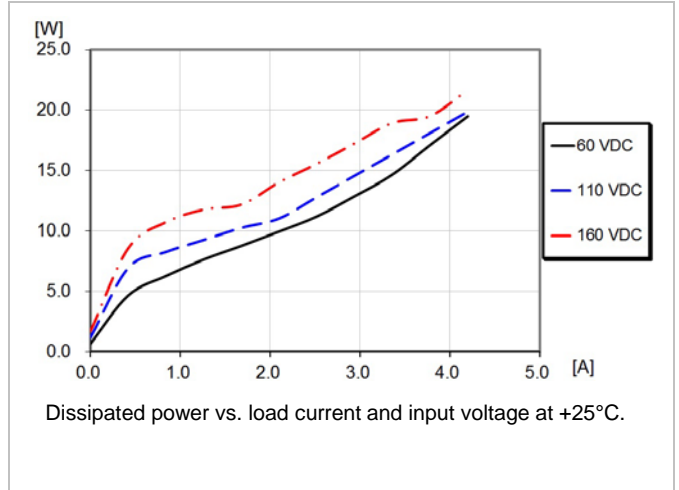

Output Current Derating

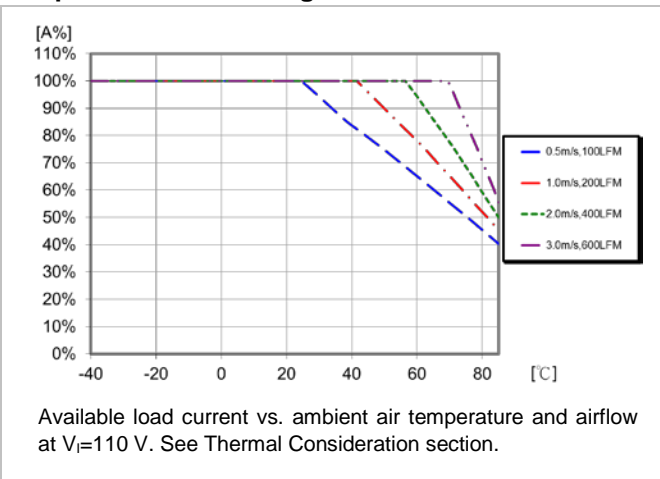

Current Limit Characteristics

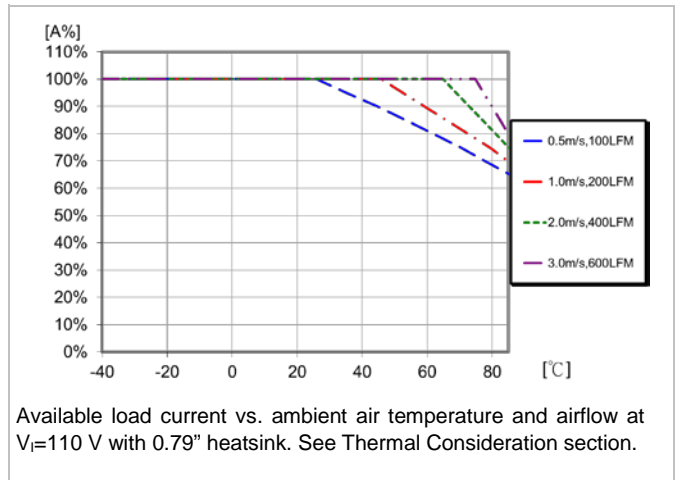
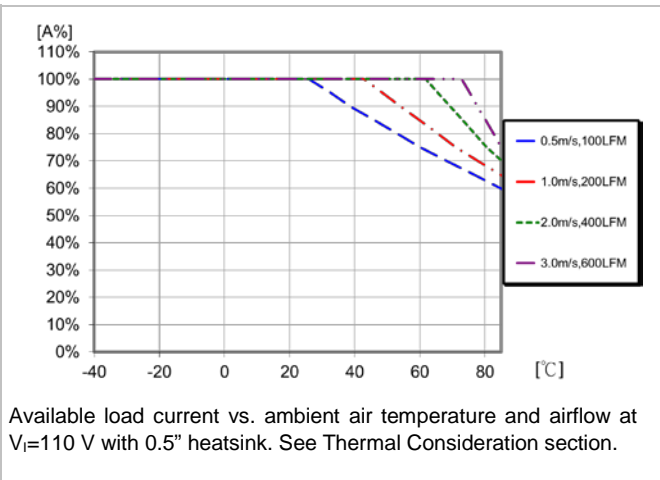
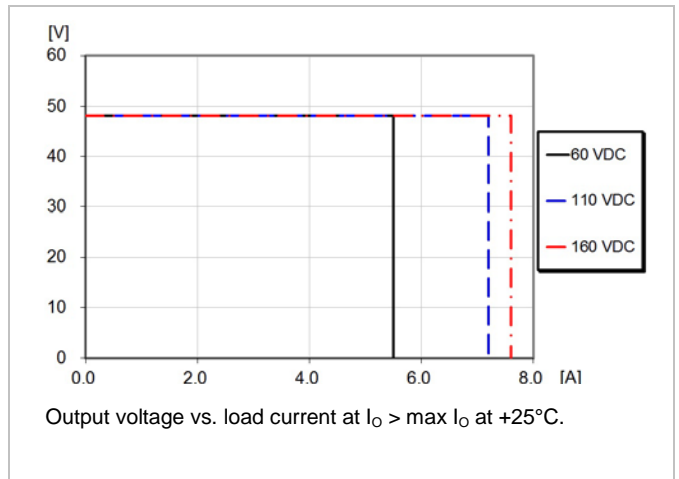

Technical Specification

PKJ 7200 series Direct Converters Input
60-160 V, Output up to 16.8 A / 200 W

28701-BMR 714 Rev B

November 2019

© Flex

Typical Characteristics
48 V, 4.2 A / 200 W

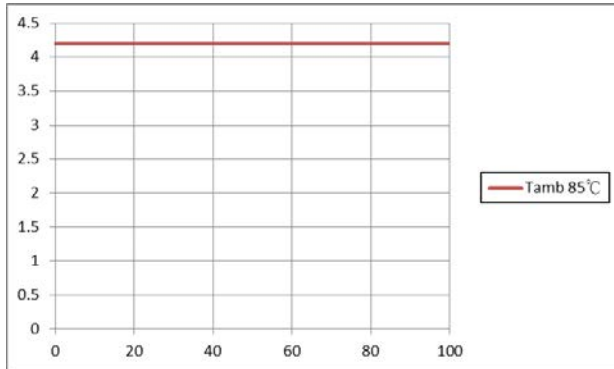
PKJ7216JPI(P)**Output Current Derating– Cold wall sealed box**

Available load current vs. cold wall temperature. VI = 110 V. See Thermal Consideration section.

PKJ 7200 series Direct Converters Input
60-160 V, Output up to 16.8 A / 200 W

28701-BMR 714 Rev B November 2019
© Flex

Typical Characteristics
48 V, 4.2 A / 200 W

PKJ7216JPI(P)

Start-up

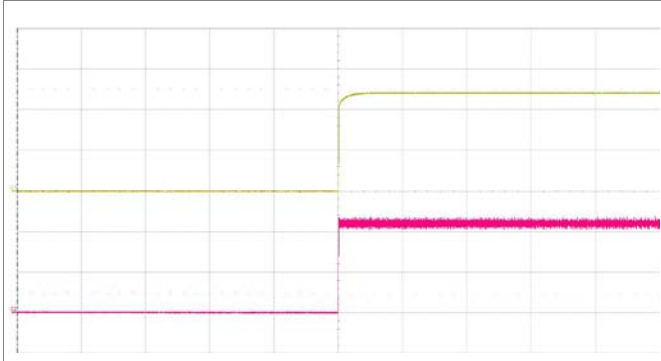

Start-up enabled by connecting V_I at:
 $T_{P1} = +25^{\circ}\text{C}$, $V_I = 110\text{ V}$,
 $I_O = 4.2\text{ A}$ resistive load.
Top trace: output voltage (20 V/div.).
Bottom trace: input voltage (50 V/div.).
Time scale: (500 ms/div.).

Shut-down

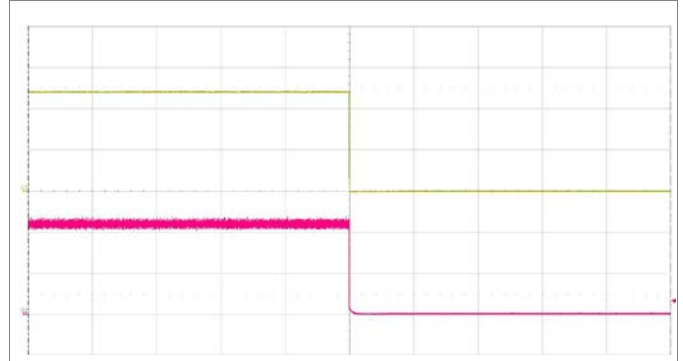

Shut-down enabled by disconnecting V_I at:
 $T_{P1} = +25^{\circ}\text{C}$, $V_I = 110\text{ V}$,
 $I_O = 4.2\text{ A}$ resistive load.
Top trace: output voltage (20 V/div.).
Bottom trace: input voltage (50 V/div.).
Time scale: (500 ms/div.).

Output Ripple & Noise

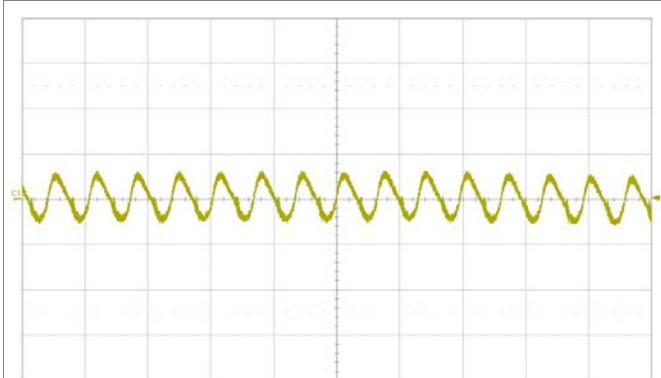

Output voltage ripple at:
 $T_{P1} = +25^{\circ}\text{C}$, $V_I = 110\text{ V}$,
 $I_O = 4.2\text{ A}$ resistive load.
Trace: output voltage (100 mV/div.).
Time scale: (5 μs /div.).
20 MHz bandwidth.

Output Load Transient Response

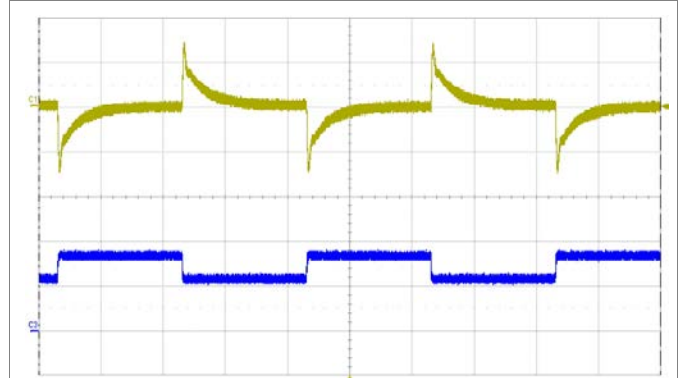

Output voltage response to load current step-
change (2.1-3.15-2.1 A) at:
 $T_{P1} = +25^{\circ}\text{C}$, $V_I = 110\text{ V}$.
Top trace: output voltage (500 mV/div.).
Bottom trace: load current (2 A/div.).
Time scale: (500 μs /div.).

Output Voltage Adjust (TRIM UP/TRIM DOWN)

Output Voltage=48V

The resistor value for an adjusted output voltage is calculated by using the following equations:

Output Voltage Adjust, Increase:

$$R_{ADJ_UP} = \left(\frac{29.221}{\Delta} - 220 \right) k\Omega$$

Output Voltage Adjust, Decrease:

$$R_{ADJ_DOWN} = \left(\frac{34.46}{\Delta} - 283.682 \right) k\Omega$$

Example:

To trim up the 48V model by 8% to 51.84V the required external resistor is:

$$R_{ADJ_UP} = \left(\frac{29.221}{0.08} - 220 \right) = 145.27k\Omega$$

Example:

To trim down the 48V model by 7% to 44.64V the required external resistor is:

$$R_{ADJ_DOWN} = \left(\frac{34.46}{0.07} - 283.682 \right) = 208.61k\Omega$$

Technical Specification

PKJ 7200 series Direct Converters Input
60-160 V, Output up to 16.8 A / 200 W

28701-BMR 714 Rev B November 2019

© Flex

Electrical Specification
54 V, 3.8 A / 200 W

PKJ7216HPI(P)

$T_{P1} = -40$ to $+110^{\circ}\text{C}$, $V_I = 60$ to 160 V, sense pins connected to output pins unless otherwise specified under Conditions.

Typical values given at: $T_{P1} = +25^{\circ}\text{C}$, $V_I = 110$ V, $I_O = \text{max } I_O$, unless otherwise specified under Conditions.

At least 100 μF E-Cap be added in the input terminal for stabilize input voltage source.

Characteristics		Conditions	min	typ	max	Unit
V_I	Input voltage range		60		160	V
V_{Ioff}	Turn-off input voltage	Decreasing input voltage	54	56	58	V
V_{Ion}	Turn-on input voltage	Increasing input voltage	56	58	60	V
C_i	Internal input capacitance			2840		nF
P_O	Output power		0		200	W
η	Efficiency	50% of max I_O , $V_I = 110$ V		91.5		%
		max I_O , $V_I = 110$ V		92.5		
P_d	Power Dissipation	max I_O		16.2		W
P_{ii}	Input idling power	$I_O = 0$ A, $V_I = 110$ V		1		W
f_s	Switching frequency	0-100 % of max I_O		300		kHz

V_{Oi}	Output voltage initial setting and accuracy	$T_{P1} = +25^{\circ}\text{C}$, $V_I = 110$ V, $I_O = 3.8$ A	53.46	54	54.54	V
V_O	Output adjust range	See operating information	48.6		59.4	V
	Output voltage tolerance band	0-100% of max I_O	53.46	54	54.54	V
	Idling voltage	$I_O = 0$ A	53.46	54	54.54	V
	Line regulation	max I_O	-270		270	mV
	Load regulation	$V_I = 110$ V, 25-100% of max I_O	-540		540	mV
V_{tr}	Load transient voltage deviation	$V_I = 110$ V, Load step 50-75-50% of max I_O , $di/dt = 100\text{mA}/\mu\text{s}$, $C_{out} = 47\mu\text{F}$		± 800		mV
t_{tr}	Load transient recovery time			200	500	μs
t_r	Ramp-up time (from 10-90% of V_{Oi})	10-100% of max I_O , $T_{P1} = 25^{\circ}\text{C}$, $V_I = 110$ V		11		ms
t_s	Start-up time (from V_I connection to 90% of V_{Oi})			25		ms
t_{RC}	RC start-up time (from V_{RC} connection to 90% of V_{Oi})		max I_O		10	
RC	Sink current	See operating information	0.5			mA
	Trigger level	Decreasing / Increasing RC-voltage		0.8/2.5		V
t_f	V_I shut-down fall time (from V_I off to 10% of V_O)	max I_O		1.5		ms
		$I_O = 0$ A		4.5		s
I_O	Output current		0		3.8	A
I_{lim}	Current limit threshold	$T_{P1} < \text{max } T_{P1}$	4.8		6.3	A
I_{sc}	Short circuit current	$T_{P1} = 25^{\circ}\text{C}$, see Note 1		0.48		A
C_{out}	Recommended Capacitive Load	$T_{P1} = 25^{\circ}\text{C}$	0		1500	μF
V_{Oac}	Output ripple & noise	See ripple & noise section, V_{Oi} , max I_O , see Note 2		120	200	mVp-p
OVP	Over voltage protection	$T_{P1} = +25^{\circ}\text{C}$, $V_I = 110$ V, 0-100% of max I_O	62.1		81	V

Note 1: RMS current at OCP in hic-up mode.

Note 2: Measured by 20MHz bandwidth with 10 μF +0.1 μF X7R MLCC

PKJ 7200 series Direct Converters Input
60-160 V, Output up to 16.8 A / 200 W

28701-BMR 714 Rev B

November 2019

© Flex

Typical Characteristics
54 V, 3.8 A / 200 W

PKJ7216HPI(P)

Efficiency

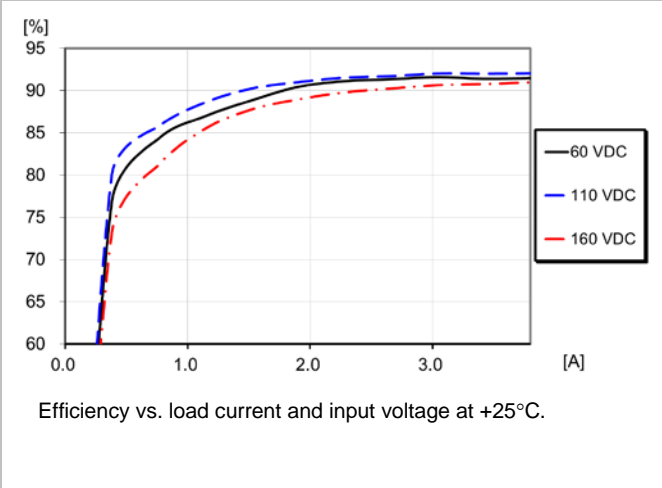

Power Dissipation

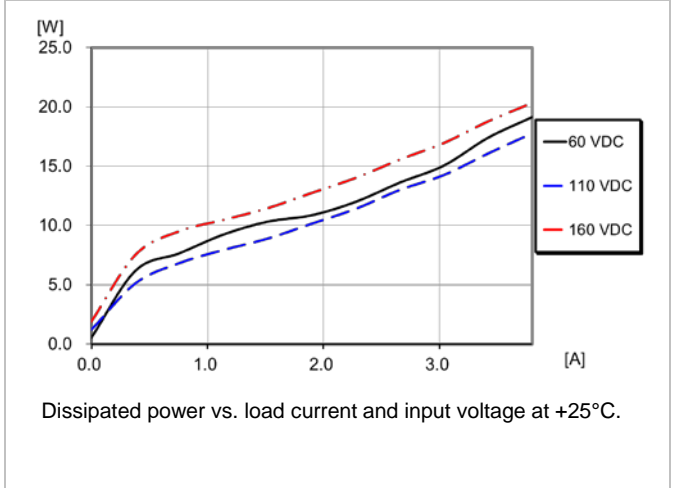

Output Current Derating

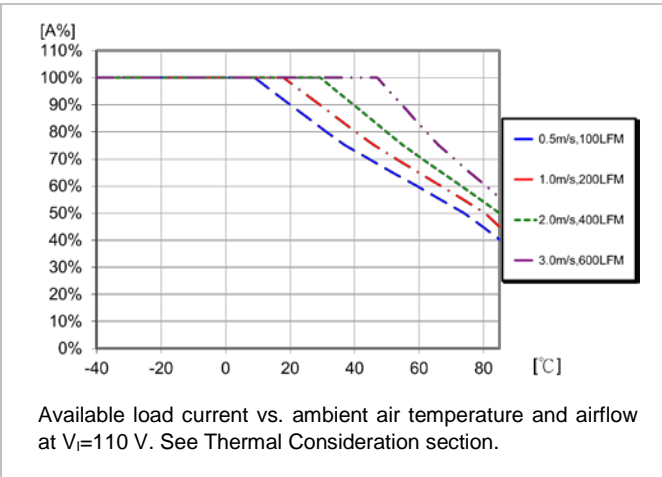

Current Limit Characteristics

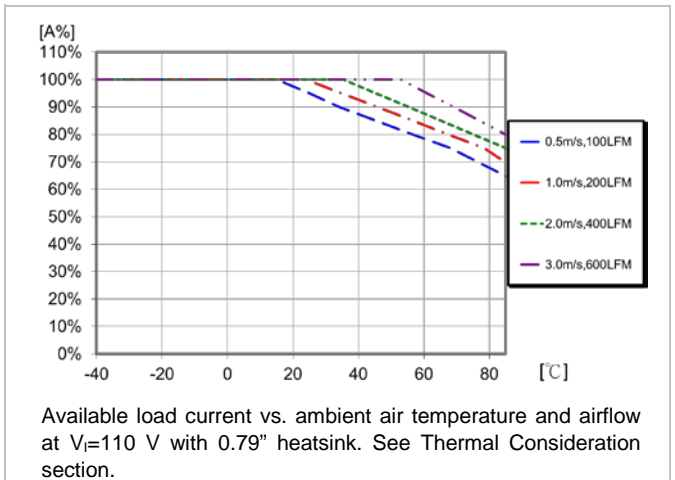
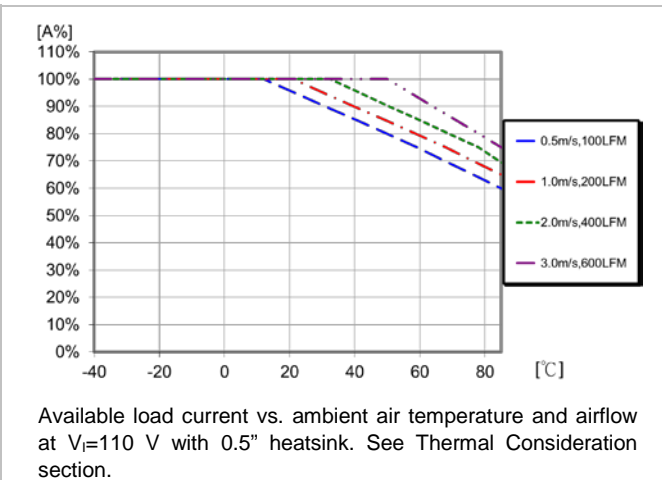
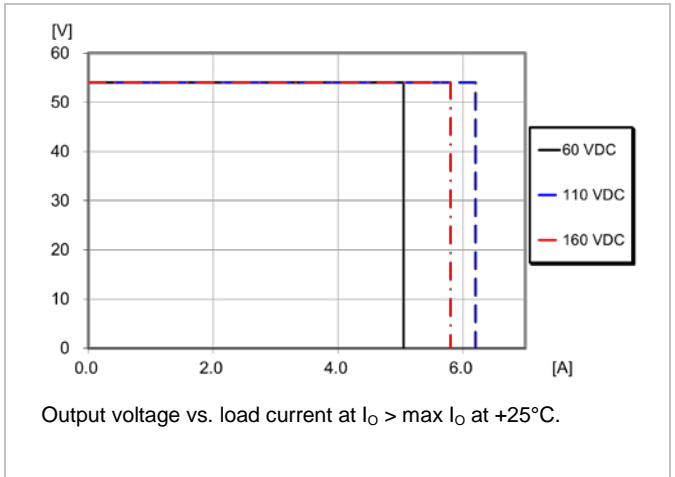

Technical Specification

PKJ 7200 series Direct Converters Input
60-160 V, Output up to 16.8 A / 200 W

28701-BMR 714 Rev B

November 2019

© Flex

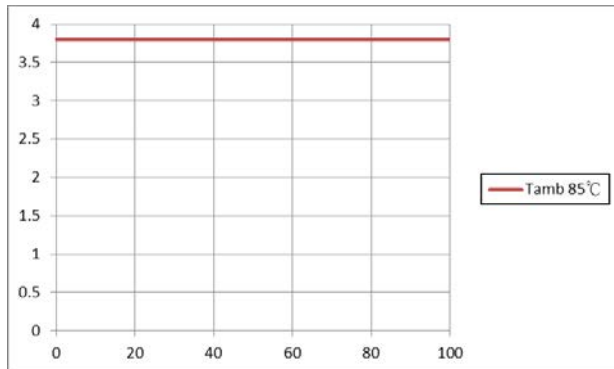
Output Current Derating– Cold wall sealed box

Available load current vs. cold wall temperature. VI = 110 V. See Thermal Consideration section.

PKJ 7200 series Direct Converters Input
60-160 V, Output up to 16.8 A / 200 W

28701-BMR 714 Rev B November 2019
© Flex

Typical Characteristics
54 V, 3.8 A / 200 W

PKJ7216HPI(P)

Start-up

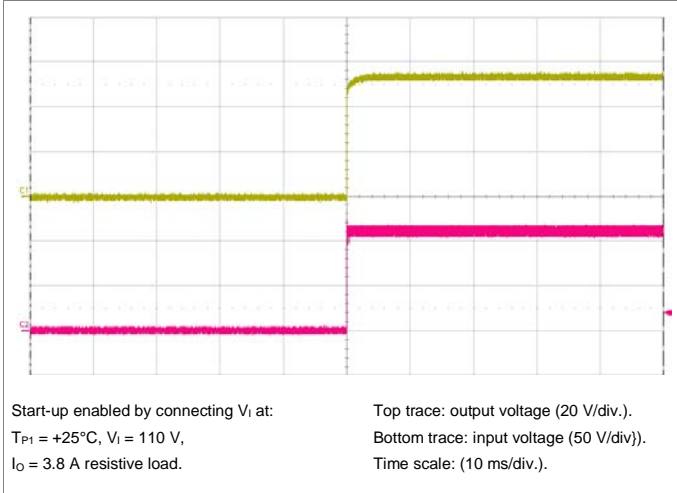

Shut-down

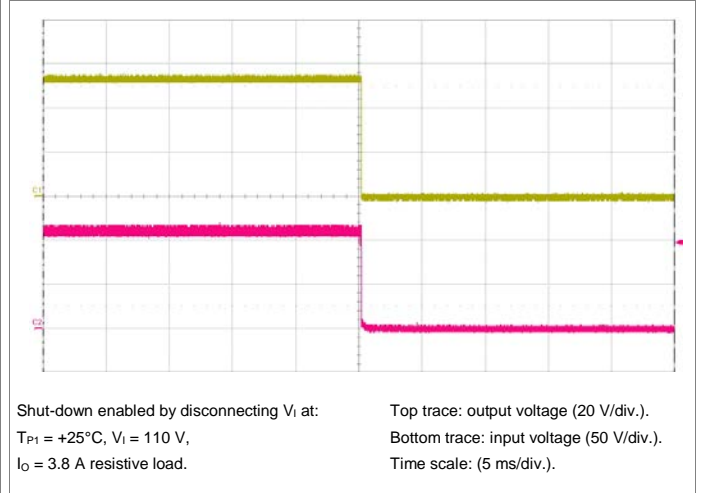

Output Ripple & Noise

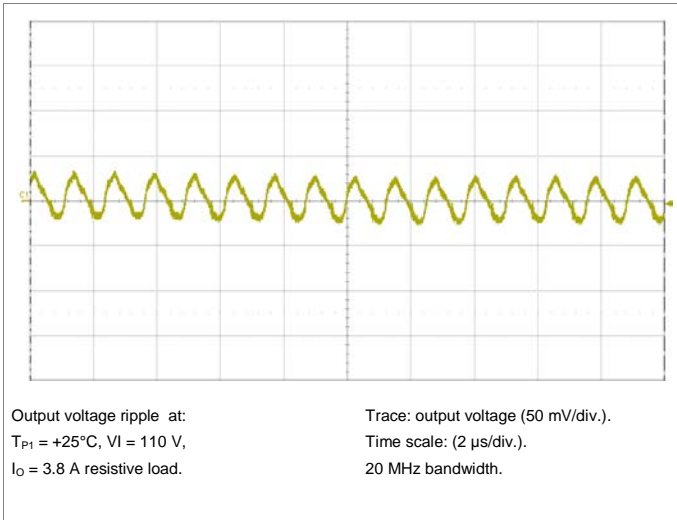

Output Load Transient Response

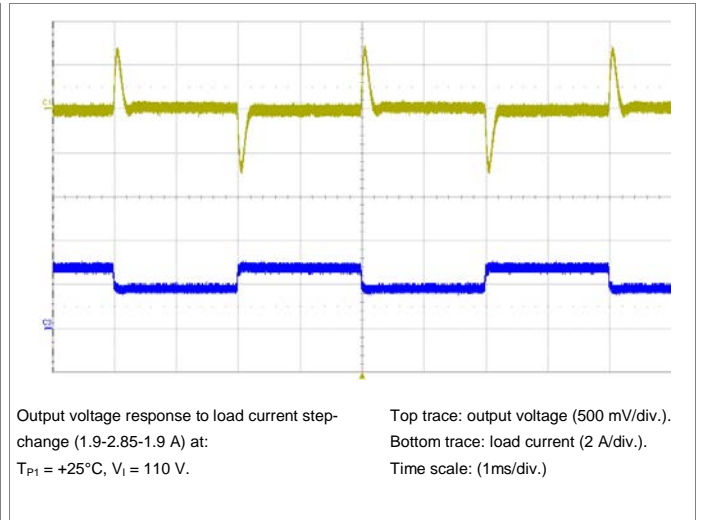

Output Voltage Adjust (TRIM UP/TRIM DOWN)

Output Voltage=54V

The resistor value for an adjusted output voltage is calculated by using the following equations:

Output Voltage Adjust, Increase:

$$R_{ADJ_UP} = \left(\frac{32.667}{\Delta} - 270 \right) k\Omega$$

Output Voltage Adjust, Decrease:

$$R_{ADJ_DOWN} = \left(\frac{40.5244}{\Delta} - 343.191 \right) k\Omega$$

Example:

To trim up the 54V model by 8% to 58.32V the required external resistor is:

$$R_{ADJ_UP} = \left(\frac{32.667}{0.08} - 270 \right) = 138.34k\Omega$$

Example:

To trim down the 54V model by 7% to 50.22V the required external resistor is:

$$R_{ADJ_DOWN} = \left(\frac{40.5244}{0.07} - 343.191 \right) = 235.73k\Omega$$

Technical Specification

PKJ 7200 series Direct Converters Input
60-160 V, Output up to 16.8 A / 200 W

28701-BMR 714 Rev B

November 2019

© Flex

EMC Specification

Conducted EMI measured according to EN50121-3-2:2015 EN55032, CISPR 32 and FCC part 15J (see test set-up). See Design Note 009 for further information. The fundamental switching frequency is 300 kHz for PKJ Series at $V_1 = 110\text{ V}$ and $\text{max } I_o$.

Conducted EMI Input terminal value (typ)

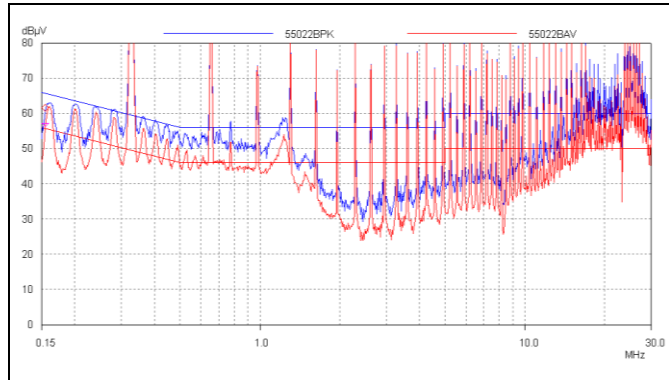

EMI without filter

Optional external filter for class B

Suggested external input filter in order to meet EN50121-3-2:2015, class B in EN 55032, CISPR 32 and FCC part 15J.

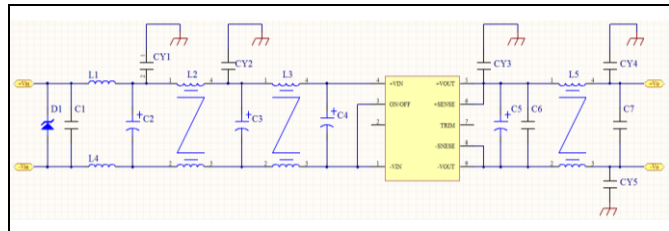

PKJ7213, PKJ7215, PKJ7216Z Filter components:
C1,C6,C7: 2.2uF CERAMIC, C2: 82uF E.L. capacitor
C3,C4: 100uF E.L. capacitor, C5: 330uF E.L. capacitor
L1, L4: 4.5uH, L2,L3: 3.25mH, L5: 480uH
CY1,CY3,CY4,CY5: 4.7nF /250VAC, CY2: 10nF/250VAC
D1: 1.5KE180A Littelfuse

PKJ7216J Filter components:
C1,C6,C7: 2.2uF CERAMIC, C2: 82uF E.L. capacitor
C3,C4: 100uF E.L. capacitor, C5: 330uF E.L. capacitor
L1, L4: 4.5uH, L2,L3: 3.25mH, L5: 480uH
CY1: 4.7nF /250VAC, CY2,CY4,CY5: 10nF/250VAC, CY3: NC
D1: 1.5KE180A Littelfuse

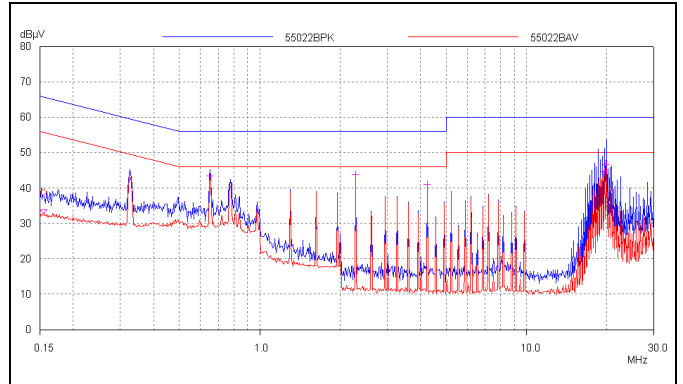

Input Line(EN50121-3-2:2015)

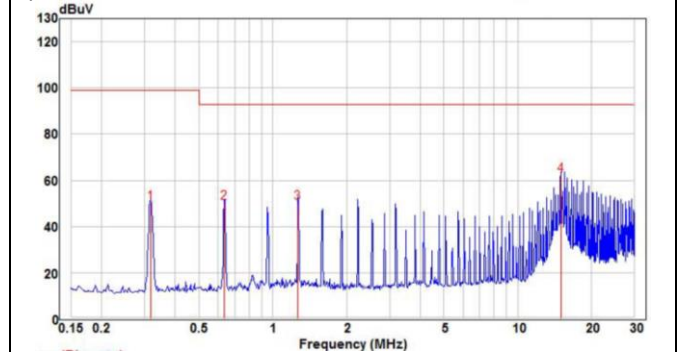

Input Neutral(EN50121-3-2:2015)

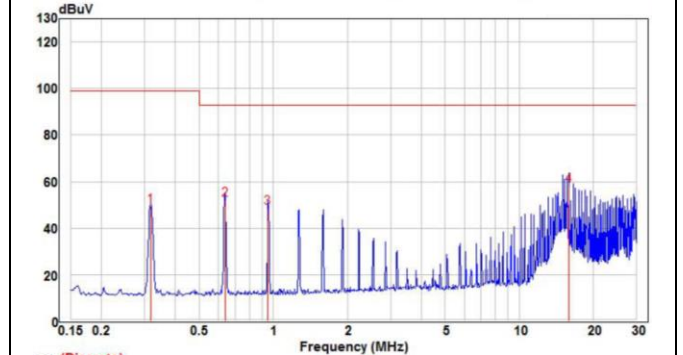

Output Positive(EN50121-3-2:2015)

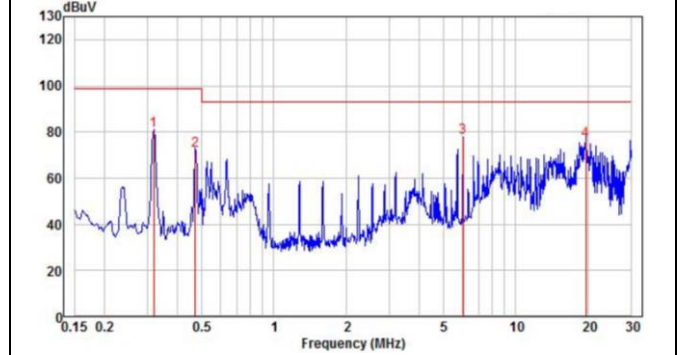

Technical Specification

PKJ 7200 series Direct Converters Input
60-160 V, Output up to 16.8 A / 200 W

28701-BMR 714 Rev B

November 2019

© Flex

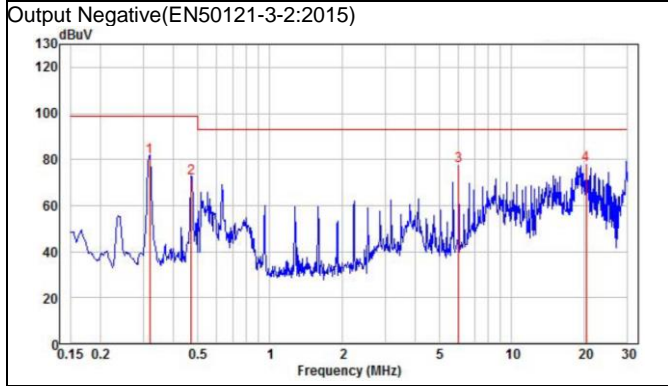

EMI with filter

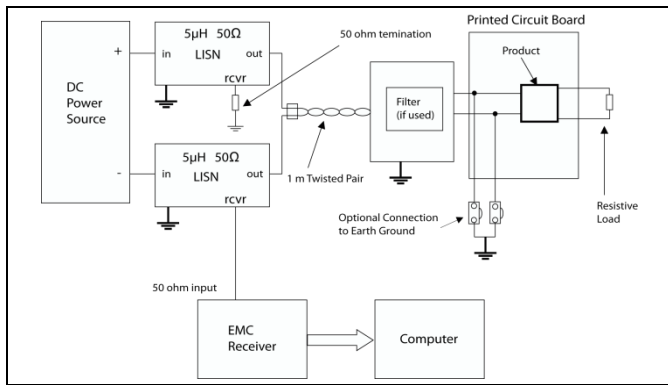

Test set-up

Layout recommendations

The radiated EMI performance of the product will depend on the PWB layout and ground layer design. It is also important to consider the stand-off of the product. If a ground layer is used, it should be connected to the output of the product and the equipment ground or chassis.

A ground layer will increase the stray capacitance in the PWB and improve the high frequency EMC performance.

Output ripple and noise

Output ripple and noise measured according to figure below. See Design Note 022 for detailed information.

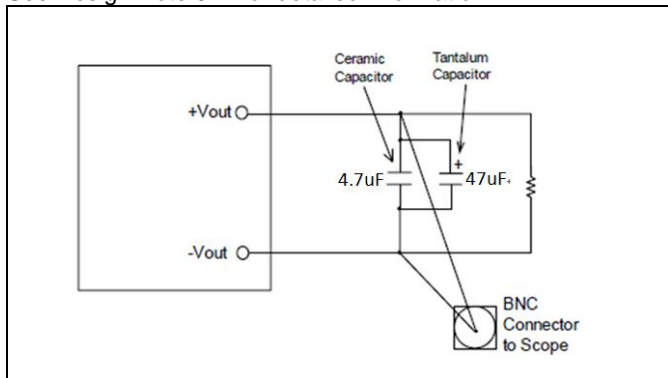

Output ripple and noise test setup

Technical Specification

PKJ 7200 series Direct Converters Input
60-160 V, Output up to 16.8 A / 200 W

28701-BMR 714 Rev B

November 2019

© Flex

Operating Information

Input Voltage

The input voltage range 60 to 160 Vdc, at input voltages exceeding 160 V, the power loss will be higher than at normal input voltage and T_{P1} must be limited to absolute max +120°C. The absolute maximum continuous input voltage is 160 Vdc.

Short duration transient disturbances can occur on the DC distribution and input of the product when a short circuit fault occurs on the equipment side of a protective device (fuse or circuit breaker). The voltage level, duration and energy of the disturbance are dependant on the particular DC distribution network characteristics and can be sufficient to damage the product unless measures are taken to suppress or absorb this energy. The transient voltage can be limited by capacitors and other energy absorbing devices like zener diodes connected across the positive and negative input conductors at a number of strategic points in the distribution network. The end-user must secure that the transient voltage will not exceed the value stated in the Absolute maximum ratings. ETSI TR 100 283 examines the parameters of DC distribution networks and provides guidelines for controlling the transient and reduce its harmful effect.

Turn-off Input Voltage

The products monitor the input voltage and will turn on and turn off at predetermined levels. The minimum hysteresis between turn on and turn off input voltage is 1.7 V.

Remote Control (RC)

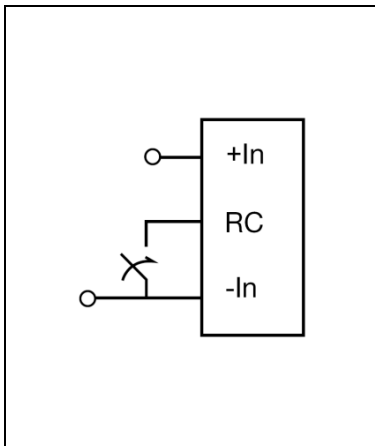

The products are fitted with a remote control function referenced to the primary negative input connection (-In), with negative and positive logic options available. The RC function allows the product to be turned on/off by an external device like a semiconductor or mechanical switch. The RC pin has an internal pull up resistor to +In.

The external device must provide a minimum required sink current to guarantee a voltage not higher than maximum voltage on the RC pin (see Electrical characteristics table). When the RC pin is left open, the voltage generated on the RC pin is 3 - 5 V.

The standard product is provided with "negative logic" RC and will be on until the RC pin is connected to the -In. To turn off the product the RC pin should be left open, or connected to a

voltage higher than 2.5 V referenced to -In. In situations where it is desired to have the product to power up automatically without the need for control signals or a switch, the RC pin can be wired directly to -In.

The second option is "positive logic" remote control, which can be ordered by adding the suffix "P" to the end of the part number. When the RC pin is left open, the product starts up automatically when the input voltage is applied. Turn off is achieved by connecting the RC pin to the -In. The product will restart automatically when this connection is opened.

See Design Note 021 for detailed information.

Input and Output Impedance

The impedance of both the input source and the load will interact with the impedance of the product. It is important that the input source has low characteristic impedance. The products are designed for stable operation without external capacitors connected to the input or output. The performance in some applications can be enhanced by addition of external capacitance as described under External Decoupling Capacitors.

If the input voltage source contains significant inductance, the addition of a 100 μ F capacitor across the input of the product will ensure stable operation. The capacitor is not required when powering the product from an input source with an inductance below 10 μ H. The minimum required capacitance value depends on the output power and the input voltage. The higher output power the higher input capacitance is needed.

External Decoupling Capacitors

When powering loads with significant dynamic current requirements, the voltage regulation at the point of load can be improved by addition of decoupling capacitors at the load. The most effective technique is to locate low ESR ceramic and electrolytic capacitors as close to the load as possible, using several parallel capacitors to lower the effective ESR. The ceramic capacitors will handle high-frequency dynamic load changes while the electrolytic capacitors are used to handle low frequency dynamic load changes. It is equally important to use low resistance and low inductance PWB layouts and cabling.

External decoupling capacitors will become part of the product's control loop. The control loop is optimized for a wide range of external capacitance and the maximum recommended value that could be used without any additional analysis is found in the Electrical specification. The ESR of the capacitors is a very important parameter. Stable operation is guaranteed with a verified ESR value of >5 m Ω across the output connections. For further information please contact your local Flex representative.

Technical Specification

PKJ 7200 series Direct Converters Input
60-160 V, Output up to 16.8 A / 200 W

28701-BMR 714 Rev B

November 2019

© Flex

Output Voltage Adjust (V_{adj})

The products have an Output Voltage Adjust pin (V_{adj}). This pin can be used to adjust the output voltage above or below Output voltage initial setting.

When increasing the output voltage, the voltage at the output pins (including any remote sense compensation) must be kept below the threshold of the over voltage protection, (OVP) to prevent the product from shutting down. At increased output voltages the maximum power rating of the product remains the same, and the max output current must be decreased correspondingly.

To increase the voltage the resistor should be connected between the V_{adj} pin and +Out pin. The resistor value of the Output voltage adjust function is according to information given under the Output section for the respective product. To decrease the output voltage, the resistor should be connected between the V_{adj} pin and -Out pin.

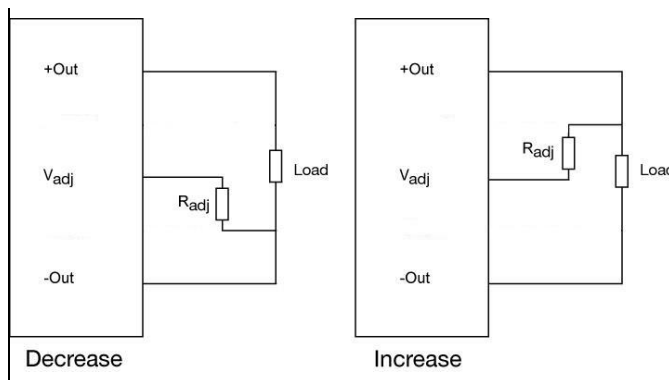
**Parallel Operation**

Two products may be paralleled for redundancy if the total power is equal or less than P_O max. It is not recommended to parallel the products without using external current sharing circuits.

For further information please contact your local Flex representative.

Remote Sense

The products have remote sense that can be used to compensate for voltage drops between the output and the point of load. The sense traces should be located close to the PWB ground layer to reduce noise susceptibility. The remote sense circuitry will compensate for up to 10% voltage drop between output pins and the point of load.

If the remote sense is not needed +Sense should be connected to +Out and -Sense should be connected to -Out.

Over Temperature Protection (OTP)

The products are protected from thermal overload by an internal over temperature shutdown circuit.

When T_{P1} as defined in thermal consideration section exceeds 120°C the product will shut down. The product will make

continuous attempts to start up (non-latching mode) and resume normal operation automatically when the temperature has dropped >10°C below the temperature threshold.

Over Voltage Protection (OVP)

The products have output over voltage protection that will prevent output voltage to exceed the specified value in technical specification. The product will make continuous attempts to start up (non-latching mode) and resume normal operation automatically after removal of the over voltage condition.

Over Current Protection (OCP)

The products include current limiting circuitry for protection at continuous overload. The output voltage will decrease towards zero for output currents in excess of max output current (max I_O). The product will resume normal operation after removal of the overload. The load distribution should be designed for the maximum output short circuit current specified.

Thermal Consideration**General**

The products are designed to operate in different thermal environments and sufficient cooling must be provided to ensure reliable operation.

For products mounted on a PWB without a heat sink attached, cooling is achieved mainly by conduction, from the pins to the host board, and convection, which is dependent on the airflow across the product. Increased airflow enhances the cooling of the product. The Output Current Derating graph found in the Output section for each model provides the available output current vs. ambient air temperature and air velocity at $V_I = 110$ V.

The product is tested on a 250 x 250 mm, 70 μ m (2 oz), 4-layer test board mounted vertically in a wind tunnel with a cross-section of 256 x 250 mm.

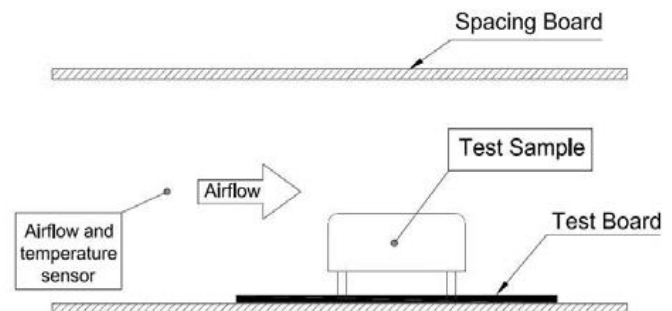

For products with base plate used in a sealed box/cold wall application, cooling is achieved mainly by conduction through the cold wall. The Output Current Derating graphs are found in the Output section for each model. The product is tested in a sealed box test set up with ambient temperatures 85 °C. See Design Note 028 for further details.

Technical Specification

PKJ 7200 series Direct Converters Input
60-160 V, Output up to 16.8 A / 200 W

28701-BMR 714 Rev B November 2019
© Flex

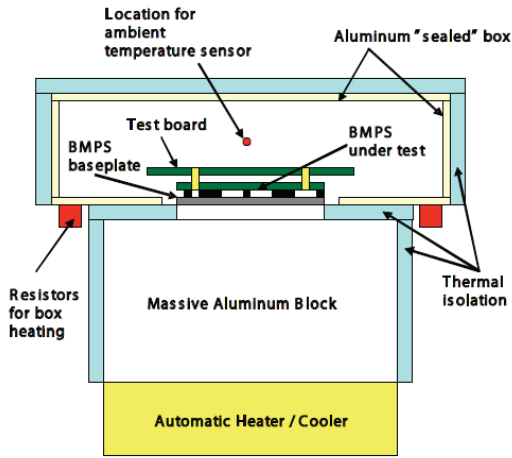

Connections

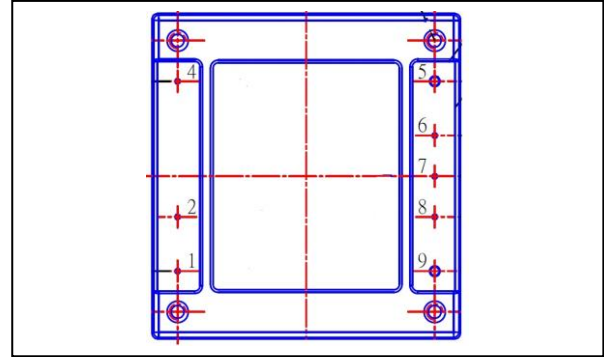

Bottom view

Definition of product operating temperature

The product operating temperatures is used to monitor the temperature of the product, and proper thermal conditions can be verified by measuring the temperature at positions P1. The temperature at this position (T_{P1}) should not exceed the maximum temperatures in the table below. Temperature above maximum T_{P1} , measured at the reference point P1 are not allowed and may cause permanent damage.

Pin	Designation	Function
1	+In	Positive input
2	RC	Remote control
4	-In	Negative input
5	-Out	Negative output
6	-Sense	Negative remote sense
7	V_{adj}	Output voltage adjust
8	+Sense	Positive remote sense
9	+Out	Positive output

Position	Description	Max Temp.
P1	Reference point	$T_{P1}=110^{\circ}C$

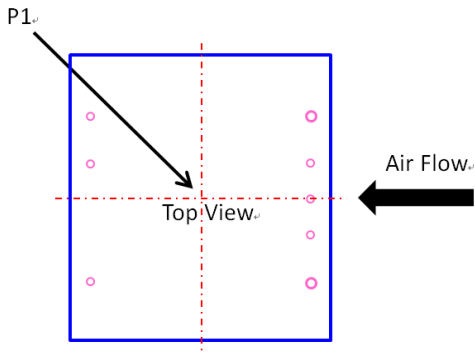

Reference point on PKJ72XX variant

Technical Specification

PKJ 7200 series Direct Converters Input
60-160 V, Output up to 16.8 A / 200 W

28701-BMR 714 Rev B

November 2019

© Flex

Mechanical Information - Enclosure Type

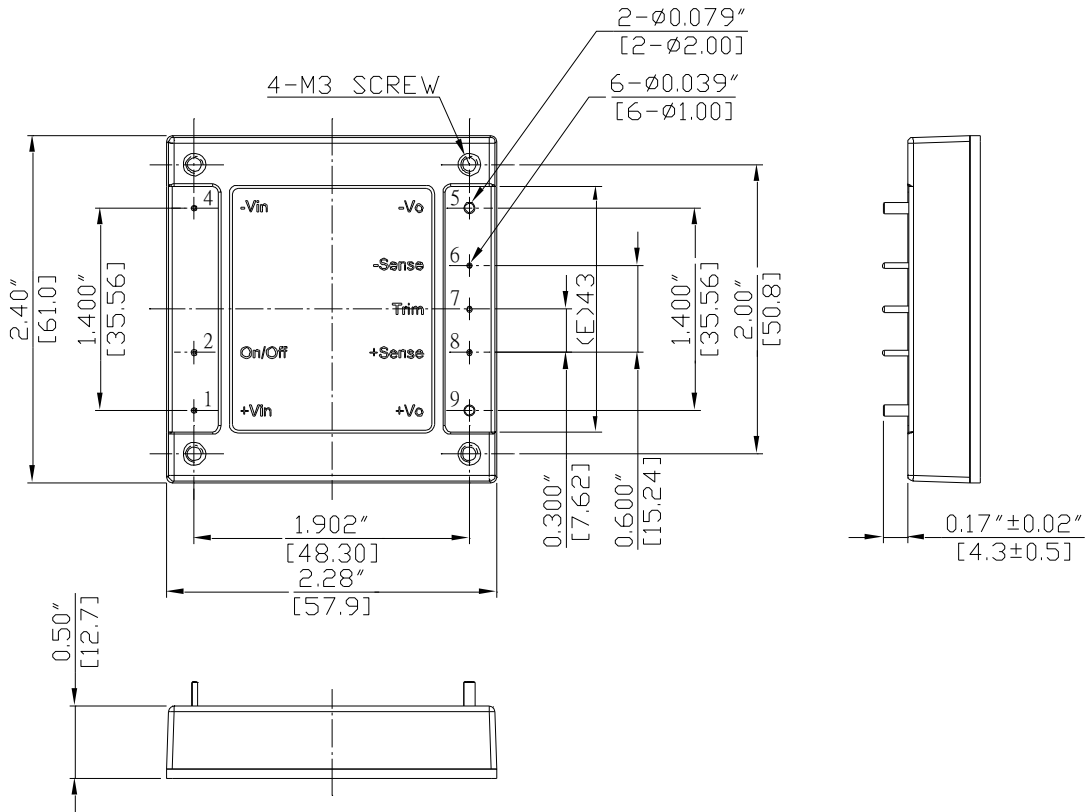

Notes:

1.Pins:

Material: Copper alloy

Plating: Matte Tin over Nickle plate

2.Weight: typical 100g

All dimensions in inches (mm).

Tolerance .xx= ±0.02"

.xxx=±0.010"

3. The screw locked torque: MAX 4.0kgf-cm/0.39N-m

Technical Specification

PKJ 7200 series Direct Converters Input
60-160 V, Output up to 16.8 A / 200 W

28701-BMR 714 Rev B

November 2019

© Flex

Soldering Information - Hole Mounting

The hole mounted product is intended for plated through hole mounting by wave or manual soldering. The pin temperature is specified to maximum to 270°C for maximum 10 seconds.

A maximum preheat rate of 4°C/s and maximum preheat temperature of 150°C is suggested. When soldering by hand, care should be taken to avoid direct contact between the hot soldering iron tip and the pins for more than a few seconds in order to prevent overheating.

A no-clean flux is recommended to avoid entrapment of cleaning fluids in cavities inside the product or between the product and the host board. The cleaning residues may affect long time reliability and isolation voltage.

Delivery Package Information

The products are delivered in antistatic clamshell trays

Package

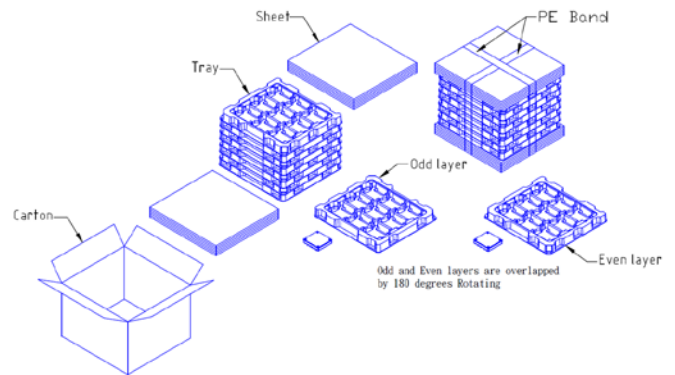

Tray Specifications	
Material	Antistatic PS
Surface resistance	$10^7 < \text{Ohm/square} < 10^{11}$
Bakeability	This tray is not bake-able
Tray thickness	26 mm [1.0236 inch]
Box capacity	72 products (8 full trays/box)
Tray weight	80 g empty, 980 g full tray

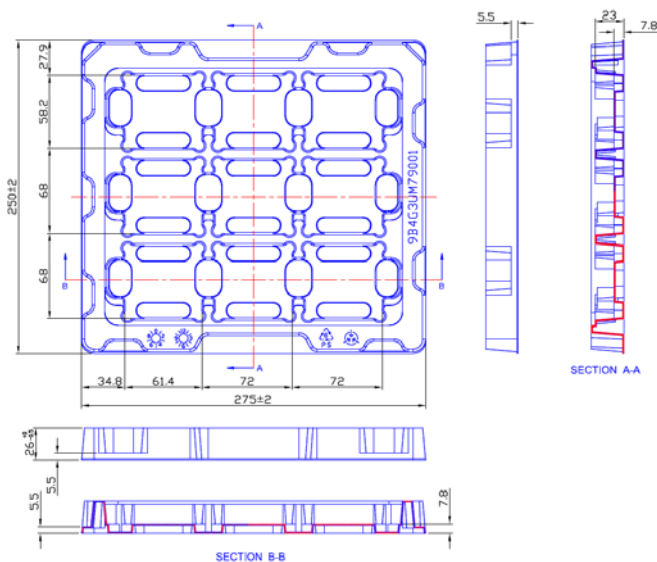

Technical Specification

PKJ 7200 series Direct Converters Input 60-160 V, Output up to 16.8 A / 200 W	28701-BMR 714 Rev B	November 2019
	© Flex	

Product Qualification Specification

Characteristics			
External visual inspection	IPC-A-610		
Change of temperature (Temperature cycling)	IEC 60068-2-14 Na	Temperature range Number of cycles Dwell/transfer time	-55 to 105°C 20 30 min/3 min
Cold (in operation)	IEC 60068-2-1 Ad	Temperature T _A Duration	-45°C 72 h
Damp heat	IEC 60068-2-30	Temperature Humidity Duration	45°C 95 % RH 72 hours
Dry heat	IEC 60068-2-2 Bd	Temperature Duration	125°C 1000 h
Electrostatic discharge susceptibility	IEC 61340-3-1, JESD 22-A114	Human body model (HBM)	Class 2, 2000 V
Immersion in cleaning solvents	IEC 60068-2-45 XA, method 2	Water Glycol ether {Isopropyl alcohol}	55°C 35°C {35°C}
Mechanical shock	IEC 60068-2-27 Ea	Peak acceleration Duration	200 g 6 ms
Moisture reflow sensitivity ¹	J-STD-020E	Level 1 (SnPb-eutectic) Level 3 (Pb Free)	225°C 260°C
Operational life test	MIL-STD-202G, method 108A	Duration	1000 h
Resistance to soldering heat	IEC 60068-2-20 Tb, method 1A	Solder temperature Duration	270°C 10-13 s
Robustness of terminations	IEC 60068-2-21 Test Ua1	Through hole mount products	All leads
Solderability	IEC 60068-2-20 test Ta ¹	Preconditioning Temperature, SnPb Eutectic Temperature, Pb-free	235°C 245°C
Vibration, broad band random	IEC 61373	Frequency RMS acceleration Duration	5 to 150 Hz 5 grms 5 hrs in each direction

Notes

¹ Only for products intended for wave soldering (plated through hole products)