

COMPACT POWER TWIN RELAY

for automotive applications

1 POLE x 2 - 25A (for 12V car battery)

FTR-P4 Series

■ FEATURES

- Compact for high density packaging
- High contact capacity with proven contact material (100,000 operations, 14 V, 25 A)
- Coil power savings (600mW nominal achieved with state-of-the-art magnetic analysis/design)
- Ease of PCB layout (all terminals on perimeter, coil and contact terminals separated)
- Pin compatible with low acoustic noise relay, FTR-P2
- Packaging for auto-insertion (tube packing, 30 relays/tube)
- Application examples: power window, power seat, tilt steering, door lock, sun roof, retractable antenna
- RoHS compliant
Please see page 7 for more information



■ PARTNUMBER INFORMATION

[Example] FTR-P4 C N 012 W1
 (a) (b) (c) (d) (e)

(a)	Relay type	FTR-P4	: FTR-P4-Series
(b)	Contact configuration	C	: 1 form C X 2 (H-Bridge)
(c)	Contact gap	N	: 0.25mm gap
(d)	Coil rated voltage	012	: 9.....12 VDC Coil rating table at page 3
(e)	Contact material	W1	: Silver-tin oxide indium

Actual marking does not carry the type name: "FTR"
 E.g.: Ordering code: FTR-P4CN012W1 Actual marking: P4CN012W1

FTR-P4 SERIES

■ SPECIFICATION

Item	FTR-P4		
Contact Data	Configuration	1 form C x 2 (H-Bridge)	
	Material	Silver-tin oxide indium	
	Contact path voltage drop	Max. 100mV at 1A, 12VDC	
	Contact rating	25A at 14VDC (locked motor load)	
	Max. carrying current	25A/1 hour (25 °C, 100% rated coil voltage at N.O. side, de-energized at N.C. side)	
	Max. switching power	35A 16VDC (reference)	
	Min. switching load *	6 VDC, 1A (reference)	
Life	Mechanical	Min. 10 x 10 ⁶ operations	
	Electrical	Min. 100 x 10 ³ operations, 14VDC, 25A (locked motor load) (1 operation = 1 forward and 1 reverse)	
Coil Data	Operating temperature range	-40 °C to +85 °C (no frost)	
	Storage temperature range	-40 °C to +100 °C (no frost)	
Timing Data	Operate (at nominal voltage)	Max. 10 ms (without bounce)	
	Release (at nominal voltage)	Max. 5 ms (without bounce, no diode) Max. 15 ms (without bounce, with diode)	
Insulation	Resistance (initial)	100M Ω at 500VAC	
	Dielectric withstanding voltage (initial)	500VAC	
Other	Vibration resistance	Misoperation	10 to 200Hz, acceleration 44m/s ² (4.5G), constant acceleration
		Endurance	10 to 200Hz, acceleration 44m/s ² (4.5G), constant acceleration
	Shock	Operational	100 m/s ² minimum (11±1ms)
		Withstand, no damage	1,000m/s ² minimum (6±1ms)
	Weight	Approximately 10 g	

* Minimum switching loads mentioned above are reference values. Please perform the confirmation test with actual load before production since reference values may vary according to switching frequencies, environmental conditions and expected reliability levels.

Note:

Care shall be taken on the heat generated on PC board when maximum carrying current exceeds 10A. Please perform the confirmation test with actual conditions.

■ COIL RATING

P4 Series (0.25mm contact gap)

Coil Code	Rated Coil Voltage (VDC)	Coil Resistance +/- 10% (Ohm)	Must Operate Voltage (VDC) *	Must Release Voltage (VDC) *
009	9	135	5.5 (at 20 °C)	0.7 (at 20 °C)
			6.9 (at 85 °C)	0.9 (at 85 °C)
010	10	167	6.3 (at 20 °C)	0.8 (at 20 °C)
			7.9 (at 85 °C)	1.0 (at 85 °C)
012	12	240	7.3 (at 20 °C)	1.0 (at 20 °C)
			9.2 (at 85 °C)	1.3 (at 85 °C)

■ CHARACTERISTIC DATA

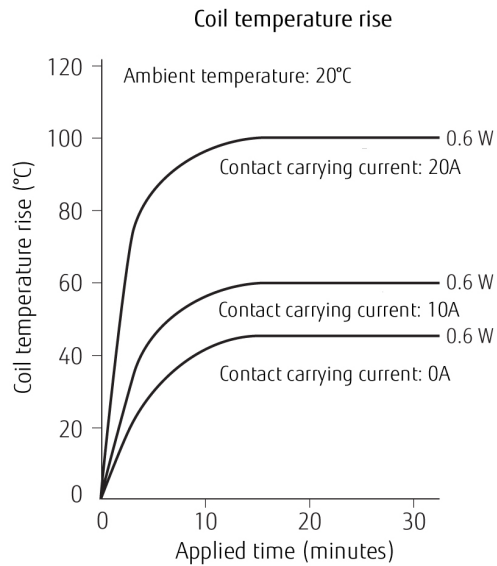
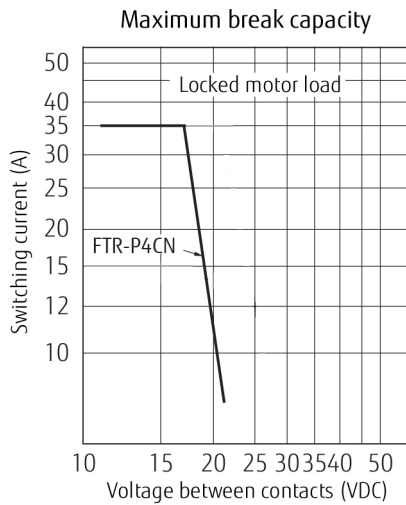

Life test (examples)

Test condition
 25A, 14VDC
 motor lock
 100,000 operations min.
 0.25 seconds ON
 9.75 seconds OFF

Test circuit

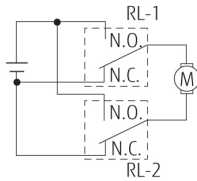

Current wave form

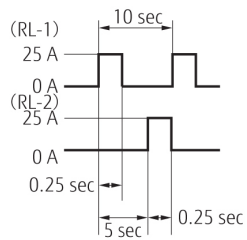

Test condition
 Inrush current 17A, 14VDC
 motor free
 300,000 operations min.
 0.25 seconds ON
 9.75 seconds OFF

Test circuit

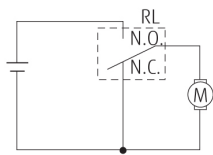

Current wave form

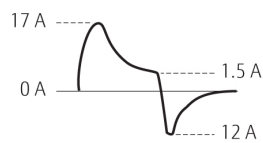

• Shift of pick-up drop-out voltage

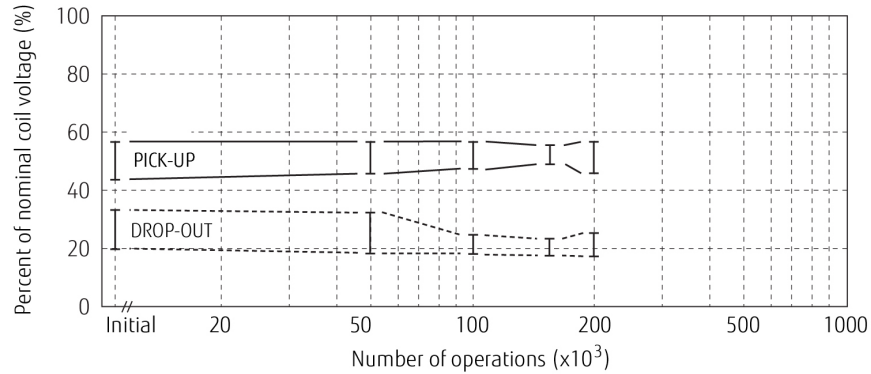

• Change of contact resistance

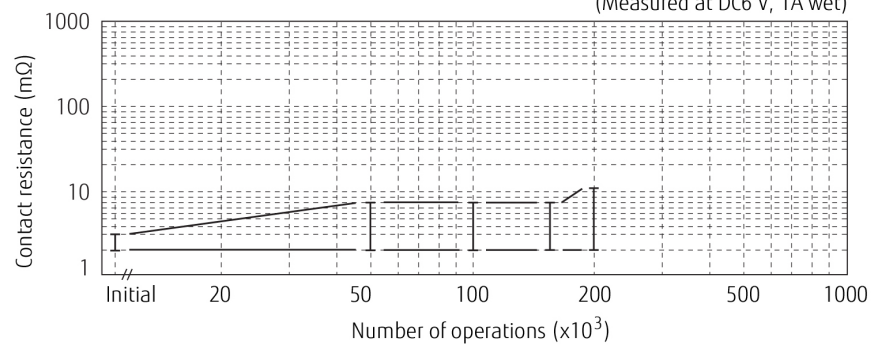

• Shift of pick-up drop-out voltage

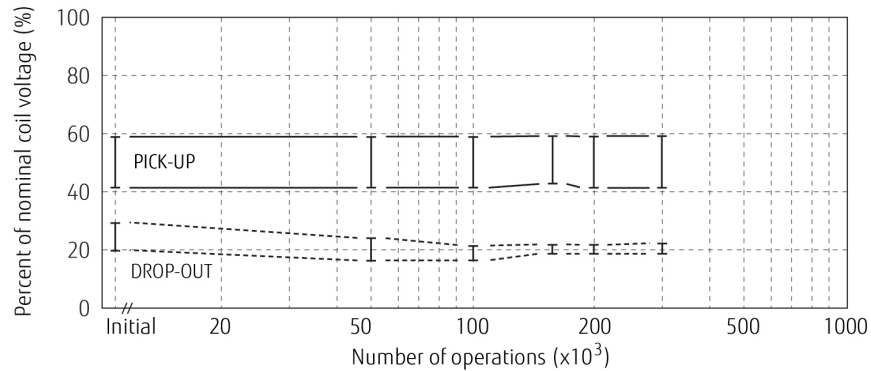

• Change of contact resistance

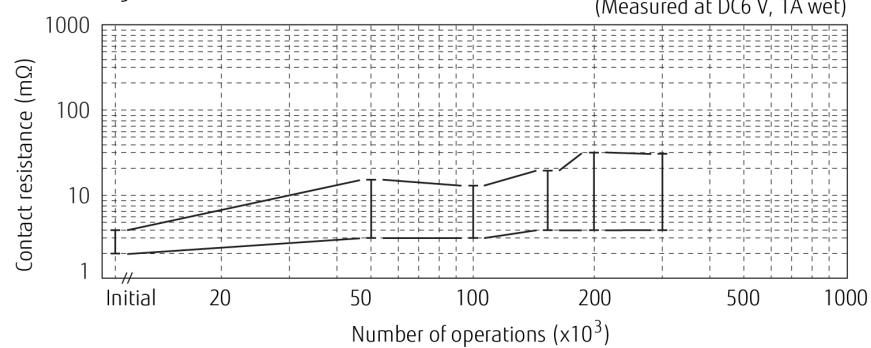

FTR-P4 SERIES

Vibration resistance characteristics

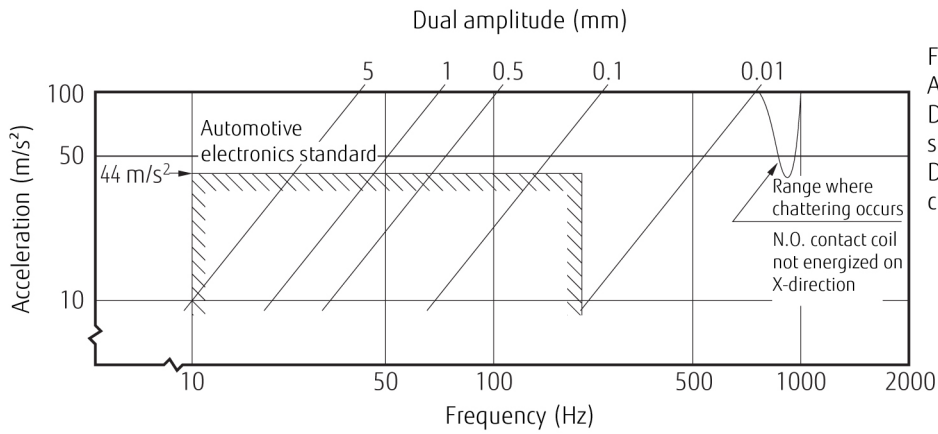

Frequency: 10~2000 Hz
 Acceleration: 100 m/s^2 max.
 Direction of vibration;
 see diagram below
 Detection level:
 chatter > 1ms

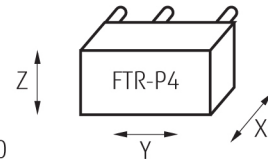

Shock resistance characteristics

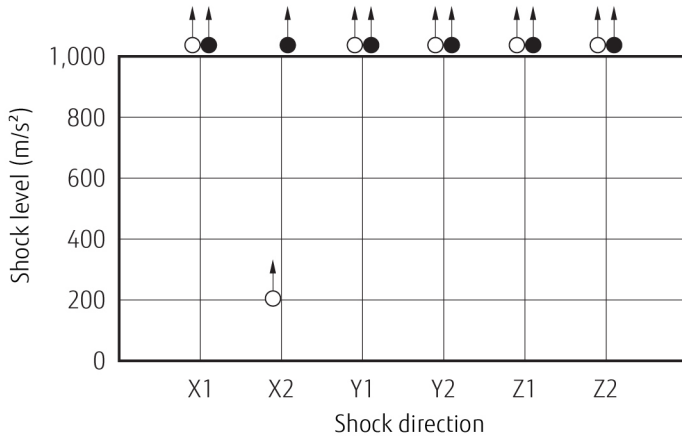

Shock application time: 6 ± 1 ms, half-sine wave
 Test material: coil energized and de-energized
 Shock direction: see diagram below
 Detection level: chatter > 1ms

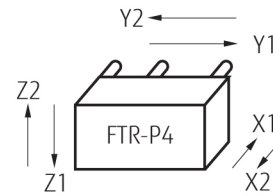

○ : break contact (coil de-energized)
 ● : make contact (coil energized)

Operating coil voltage range

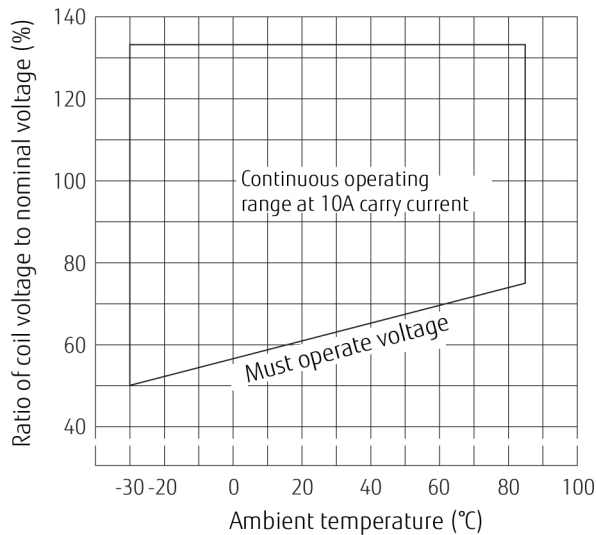

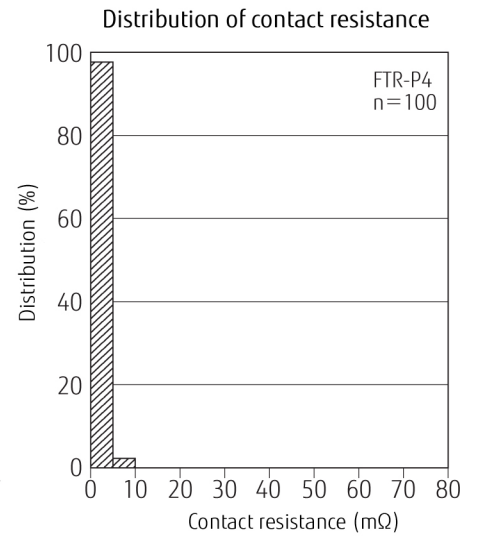
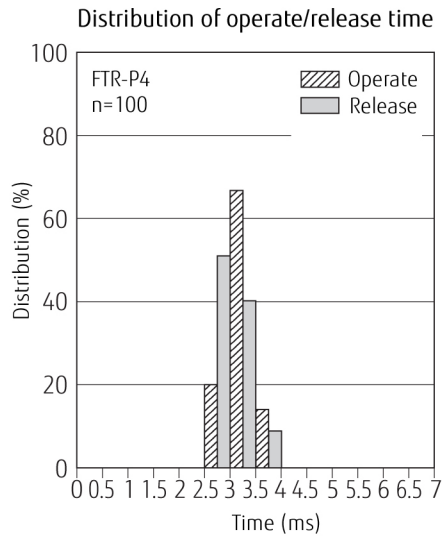
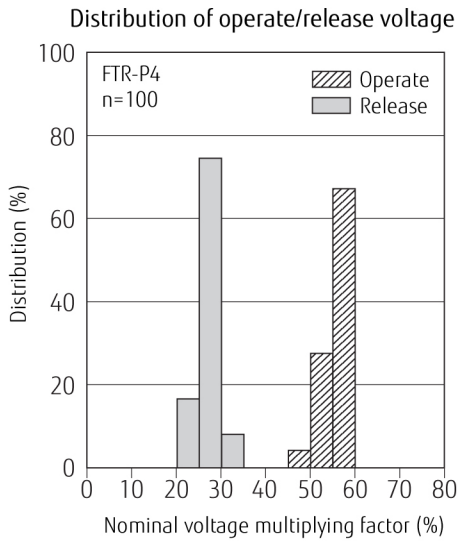

■ DIMENSIONS

● Dimensions

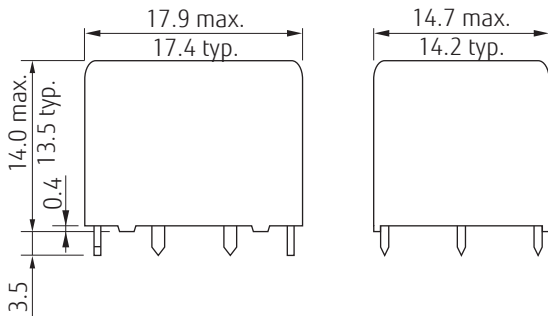

● Schematics (BOTTOM VIEW)

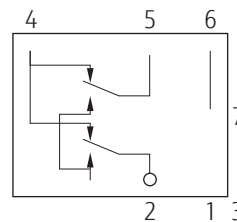

● PC board mounting hole layout (BOTTOM VIEW)

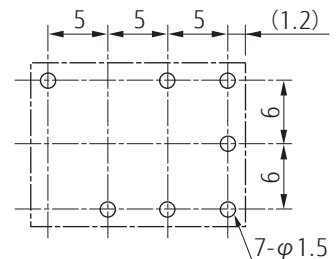

* Dimensions of the terminals do not include thickness of pre solder.
 * This datasheet provide only + tolerance for outer dimensions.
 Please ask for specification in case you need other tolerances.

Tolerance of PC board mounting hole layout :
 ±0.1 unless otherwise specified.

(): Reference
 Unit: mm

Cautions

- All values mentioned in this datasheet are provided under ideal conditions. Please perform the confirmation test before actual use.
- Reflow soldering is prohibited for standard type.
- Do not use relays in the atmosphere with sulfide gas, chloride gas or nitric oxide. Contact resistance may increase.
- Do not use silicon or silicon-containing product or materials near relays. It may cause contact failure.

RoHS Compliance and Lead Free Information

1. General Information

- All relays produced by Fujitsu Components are compliant with RoHS directive 2011/65/EU including amendments.
- Cadmium as used in electrical contacts is exempted from the RoHS directives.
As per Annex III of directive 2011/65/EU.
- All relays are lead-free. Please refer to Lead-Free Status Info for older date codes at:
<http://www.fujitsu.com/downloads/MICRO/fcai/relays/lead-free-letter.pdf>
- Lead free solder plating on relay terminals is Sn-3.0Ag-0.5Cu, unless otherwise specified.
This material has been verified to be compatible with PbSn assembly process.

2. Recommended Lead Free Solder Condition

- Recommended solder Sn-3.0Ag-0.5Cu.

Flow Solder Condition:

Pre-heating: maximum 120°C
within 90 sec.
Soldering: dip within 5 sec. at
255°C ± 5°C solder bath
Relay must be cooled by air immediately
after soldering

Solder by Soldering Iron:

Soldering Iron 30-60W
Temperature: maximum 350-360°C
Duration: maximum 3 sec.

We highly recommend that you confirm your actual solder conditions

3. Moisture Sensitivity

- Moisture Sensitivity Level standard is not applicable to electromechanical relays, unless otherwise indicated.

4. Tin Whiskers

- Dipped SnAgCu solder is known as presenting a low risk to tin whisker development. No considerable length whisker was found by our in house test.

Fujitsu Components International Headquarter Offices

Japan FUJITSU COMPONENT LIMITED Shinagawa Seaside Park Tower 19F, 12-4, Higashi-shinagawa 4-chome, Shinagawa-ku, Tokyo, 140-0002, Japan Tel: (81-3) 3450-1682 Fax: (81-3) 3474-2385 Email: fcl-contact@cs.jp.fujitsu.com Web: www.fujitsu.com/jp/fcl/	Asia Pacific FUJITSU COMPONENTS ASIA, LTD. 102E Pasir Panjang Road #01-01 Citilink Warehouse Complex Singapore 118529 Tel: (65) 6375-8560 Fax: (65) 6273-3021 Email: fcal@sg.fujitsu.com Web: www.fujitsu.com/sg/products/devices/components	Korea FUJITSU COMPONENTS KOREA LIMITED Alpha Tower #403, 645 Sampyeong-dong, Bundang-gu, Seongnam-si, Gyeonggi-do, 13524 Korea Tel: (82) 31-708-7108 Fax: (82) 31-709-7108 Email: fcal@sg.fujitsu.com www.fujitsu.com/sg/products/devices/components/
North and South America FUJITSU COMPONENTS AMERICA, INC 2290 North First Street, Suite 212 San Jose, CA 95131, USA Tel: (1-408) 745-4900 Fax: (1-408) 745-4970 Email: components@us.fujitsu.com Web: us.fujitsu.com/components	China FUJITSU ELECTRONIC COMPONENTS (SHANGHAI) CO., LTD. Unit 4306, InterContinental Center 100 Yu Tong Road, Shanghai 200070, China Tel: (86-21) 3253 0998 Fax: (86-21) 3253 0997 Email: fcal@sg.fujitsu.com Web: www.fujitsu.com/sg/products/devices/components	
Europe FUJITSU COMPONENTS EUROPE B.V. Diamantlaan 25 2132 WV Hoofddorp Netherlands Tel: (31-23) 5560910 Fax: (31-23) 5560950 Email: info@fceu.fujitsu.com Web: www.fujitsu.com/uk/components	Hong Kong FUJITSU COMPONENTS HONG KONG CO., LTD Unit 506, Inter-Continental Plaza No.94 Granville Road, Tsim Sha Tsui, Kowloon, Hong Kong Tel: (852) 2881-8495 Tex: (852) 2894-9512 Email: fcal@sg.fujitsu.com Web: www.fujitsu.com/sg/products/devices/components/	

©2019 Fujitsu Components Europe B.V. All rights reserved. All trademarks or registered trademarks are the property of their respective owners.

The contents, data and information in this datasheet are provided by Fujitsu Component Ltd. as a service only to its user and only for general information purposes.

The use of the contents, data and information provided in this datasheet is at the users' own risk.

Fujitsu has assembled this datasheet with care and will endeavor to keep the contents, data and information correct, accurate, comprehensive, complete and up to date.

Fujitsu Components Europe B.V. and affiliated companies do however not accept any responsibility or liability on their behalf, nor on behalf of its employees, for any loss or damage, direct, indirect or consequential, with respect to this datasheet, its contents, data, and information and related graphics and the correctness, reliability, accuracy, comprehensiveness, usefulness, availability and completeness thereof.

Nor do Fujitsu Components Europe B.V. and affiliated companies accept on their behalf, nor on behalf of its employees, any responsibility or liability for any representation or warrant of any kind, express or implied, including warranties of any kind for merchantability or fitness for particular use, with respect to these datasheets, its contents, data, information and related graphics and the correctness, reliability, accuracy, comprehensiveness, usefulness, availability and completeness thereof. Rev. January 15, 2019