

FDMB3900AN

Dual N-Channel PowerTrench® MOSFET

25 V, 7.0 A, 23 mΩ

Features

- Max $r_{DS(on)}$ = 23 mΩ at $V_{GS} = 10$ V, $I_D = 7.0$ A
- Max $r_{DS(on)}$ = 33 mΩ at $V_{GS} = 4.5$ V, $I_D = 5.5$ A
- Fast switching speed
- Low gate charge
- High performance trench technology for extremely low $r_{DS(on)}$
- High power and current handling capability
- RoHS Compliant



General Description

These N-Channel Logic Level MOSFETs are produced using Fairchild Semiconductor's advanced PowerTrench® process that has been especially tailored to minimize the on-state resistance and yet maintain superior switching performance.

These devices are well suited for low voltage and battery powered applications where the low in-line power loss and fast switching are required.

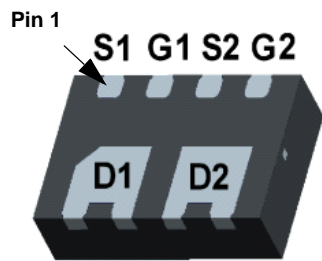

MicroFET 3X1.9

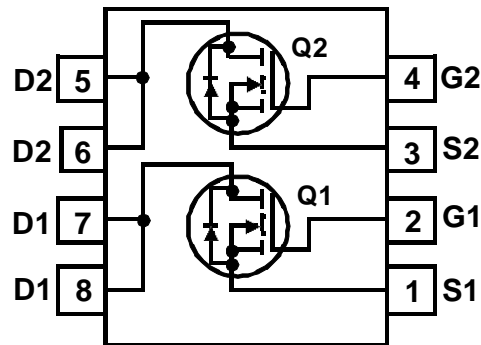

MOSFET Maximum Ratings $T_A = 25^\circ\text{C}$ unless otherwise noted

Symbol	Parameter	Rated	Units
V_{DS}	Drain to Source Voltage	25	V
V_{GS}	Gate to Source Voltage	±20	V
I_D	Drain Current -Continuous	$T_A = 25^\circ\text{C}$ (Note 1a)	7.0
	-Pulsed		28
P_D	Power Dissipation	$T_A = 25^\circ\text{C}$ (Note 1a)	1.6
	Power Dissipation	$T_A = 25^\circ\text{C}$ (Note 1b)	0.8
T_J, T_{STG}	Operating and Storage Junction Temperature Range	-55 to +150	$^\circ\text{C}$

Thermal Characteristics

$R_{\theta JA}$	Thermal Resistance, Junction to Ambient	(Note 1a)	80	$^\circ\text{C/W}$
$R_{\theta JA}$	Thermal Resistance, Junction to Ambient	(Note 1b)	165	

Package Marking and Ordering Information

Device Marking	Device	Package	Reel Size	Tape Width	Quantity
3900	FDMB3900AN	MicroFET 3X1.9	7"	8 mm	3000 units

Electrical Characteristics $T_J = 25\text{ }^\circ\text{C}$ unless otherwise noted

Symbol	Parameter	Test Conditions	Min	Typ	Max	Units
--------	-----------	-----------------	-----	-----	-----	-------

Off Characteristics

BV_{DSS}	Drain to Source Breakdown Voltage	$I_D = 250\text{ }\mu\text{A}$, $V_{GS} = 0\text{ V}$	25			V
$\frac{\Delta BV_{DSS}}{\Delta T_J}$	Breakdown Voltage Temperature Coefficient	$I_D = 250\text{ }\mu\text{A}$, referenced to $25\text{ }^\circ\text{C}$		17		mV/ $^\circ\text{C}$
I_{DSS}	Zero Gate Voltage Drain Current	$V_{DS} = 20\text{ V}$, $V_{GS} = 0\text{ V}$			1	μA
I_{GSS}	Gate to Source Leakage Current	$V_{GS} = \pm 20\text{ V}$, $V_{DS} = 0\text{ V}$			± 100	nA

On Characteristics

$V_{GS(th)}$	Gate to Source Threshold Voltage	$V_{GS} = V_{DS}$, $I_D = 250\text{ }\mu\text{A}$	1.0	2.0	3.0	V
$\frac{\Delta V_{GS(th)}}{\Delta T_J}$	Gate to Source Threshold Voltage Temperature Coefficient	$I_D = 250\text{ }\mu\text{A}$, referenced to $25\text{ }^\circ\text{C}$		-6		mV/ $^\circ\text{C}$
$r_{DS(on)}$	Static Drain to Source On Resistance	$V_{GS} = 10\text{ V}$, $I_D = 7.0\text{ A}$		19	23	m Ω
		$V_{GS} = 4.5\text{ V}$, $I_D = 5.5\text{ A}$		26	33	
		$V_{GS} = 10\text{ V}$, $I_D = 7.0\text{ A}$ $T_J = 125\text{ }^\circ\text{C}$		26	32	
g_{FS}	Forward Transconductance	$V_{DS} = 5\text{ V}$, $I_D = 7.0\text{ A}$		27		S

Dynamic Characteristics

C_{iss}	Input Capacitance	$V_{DS} = 13\text{ V}$, $V_{GS} = 0\text{ V}$ $f = 1\text{ MHz}$		650	890	pF
C_{oss}	Output Capacitance			151	200	pF
C_{rss}	Reverse Transfer Capacitance			141	215	pF
R_g	Gate Resistance			0.8		Ω

Switching Characteristics

$t_{d(on)}$	Turn-On Delay Time	$V_{DD} = 13\text{ V}$, $I_D = 7.0\text{ A}$ $V_{GS} = 10\text{ V}$, $R_{GEN} = 6\text{ }\Omega$		6	12	ns
t_r	Rise Time			3	10	ns
$t_{d(off)}$	Turn-Off Delay Time			15	26	ns
t_f	Fall Time			3	10	ns
$Q_g(TOT)$	Total Gate Charge		$V_{GS} = 0\text{ V to }10\text{ V}$		11	17
	Total Gate Charge	$V_{GS} = 0\text{ V to }5\text{ V}$	$V_{DD} = 13\text{ V}$ $I_D = 7.0\text{ A}$	7	10	nC
Q_{gs}	Gate to Source Charge			2.0		nC
Q_{gd}	Gate to Drain "Miller" Charge			3.0		nC

Drain-Source Diode Characteristics

V_{SD}	Source to Drain Diode Forward Voltage	$V_{GS} = 0\text{ V}$, $I_S = 1.25\text{ A}$ (Note 2)		0.8	1.2	V
		$V_{GS} = 0\text{ V}$, $I_S = 7.0\text{ A}$ (Note 2)		0.9	1.2	
t_{rr}	Reverse Recovery Time	$I_F = 7.0\text{ A}$, $di/dt = 100\text{ A}/\mu\text{s}$		14	24	ns
Q_{rr}	Reverse Recovery Charge			3	10	nC

NOTES:

1. $R_{\theta JA}$ is determined with the device mounted on a 1 in^2 pad 2 oz copper pad on a $1.5 \times 1.5\text{ in.}$ board of FR-4 material. $R_{\theta JC}$ is guaranteed by design while $R_{\theta CA}$ is determined by the user's board design.

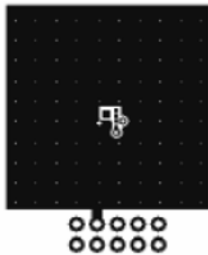

a. $80\text{ }^\circ\text{C/W}$ when mounted on a 1 in^2 pad of 2oz copper



b. $165\text{ }^\circ\text{C/W}$ when mounted on a minimum pad of 2 oz copper

2. Pulse Test: Pulse Width < $300\text{ }\mu\text{s}$, Duty cycle < 2.0% .

Typical Characteristics $T_J = 25^\circ\text{C}$ unless otherwise noted

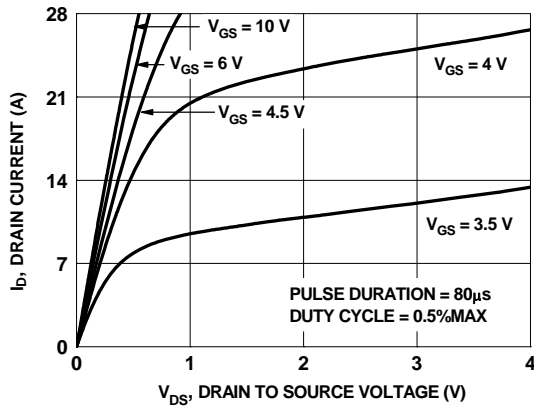

Figure 1. On-Region Characteristics

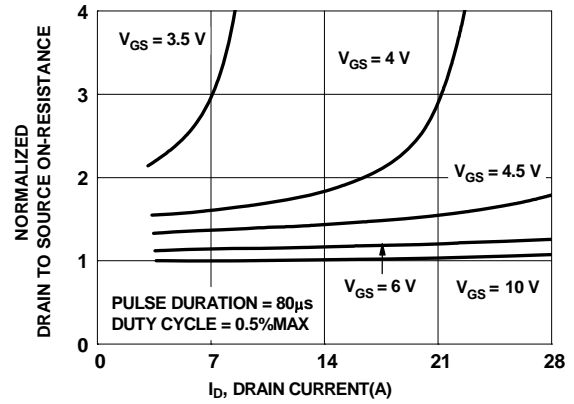

Figure 2. Normalized On-Resistance vs Drain Current and Gate Voltage

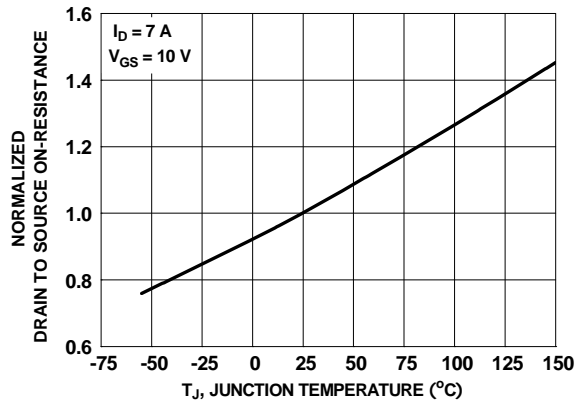

Figure 3. Normalized On-Resistance vs Junction Temperature

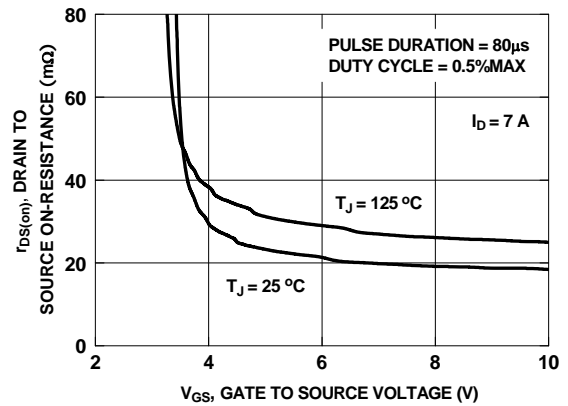

Figure 4. On-Resistance vs Gate to Source Voltage

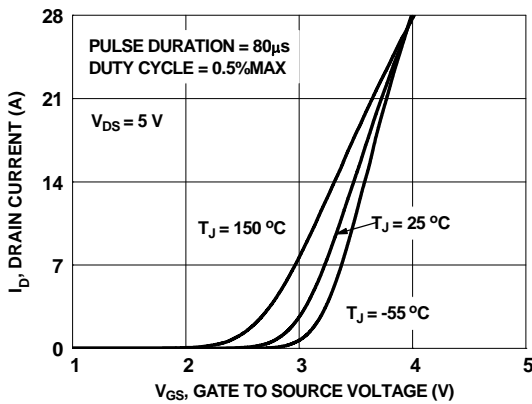

Figure 5. Transfer Characteristics

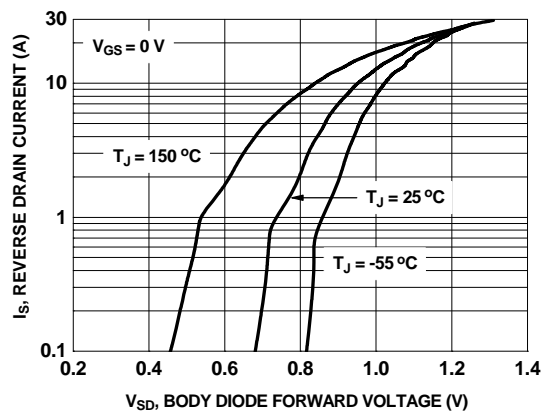

Figure 6. Source to Drain Diode Forward Voltage vs Source Current

Typical Characteristics $T_J = 25^\circ\text{C}$ unless otherwise noted

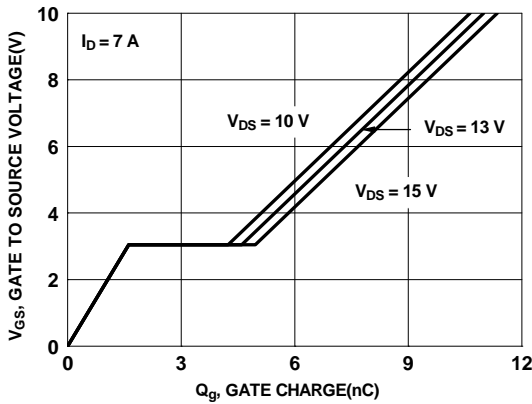

Figure 7. Gate Charge Characteristics

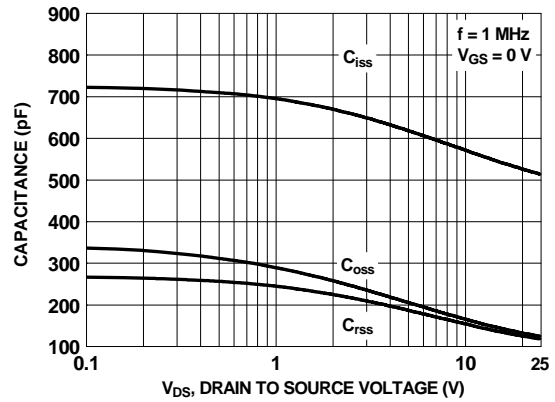

Figure 8. Capacitance vs Drain to Source Voltage

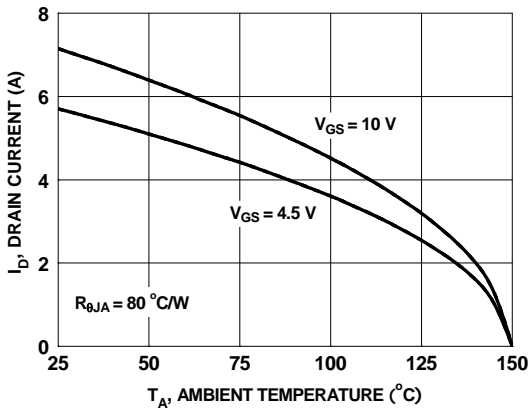

Figure 9. Maximum Continuous Drain Current vs Ambient Temperature

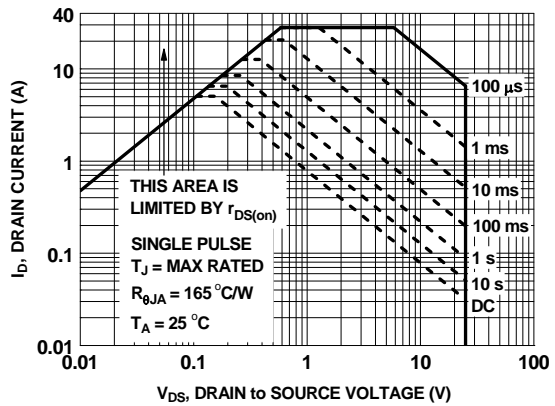

Figure 10. Forward Bias Safe Operating Area

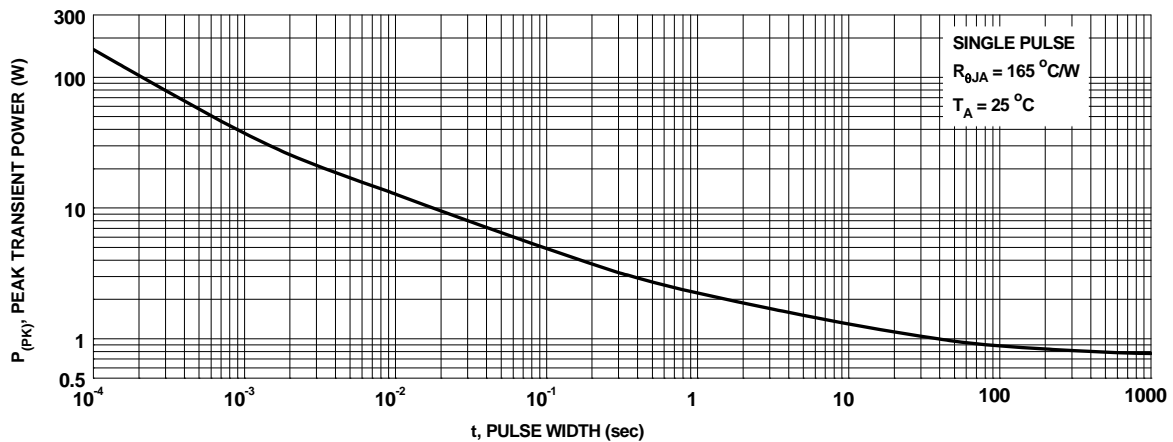

Figure 11. Single Pulse Maximum Power Dissipation

Typical Characteristics $T_J = 25^\circ\text{C}$ unless otherwise noted

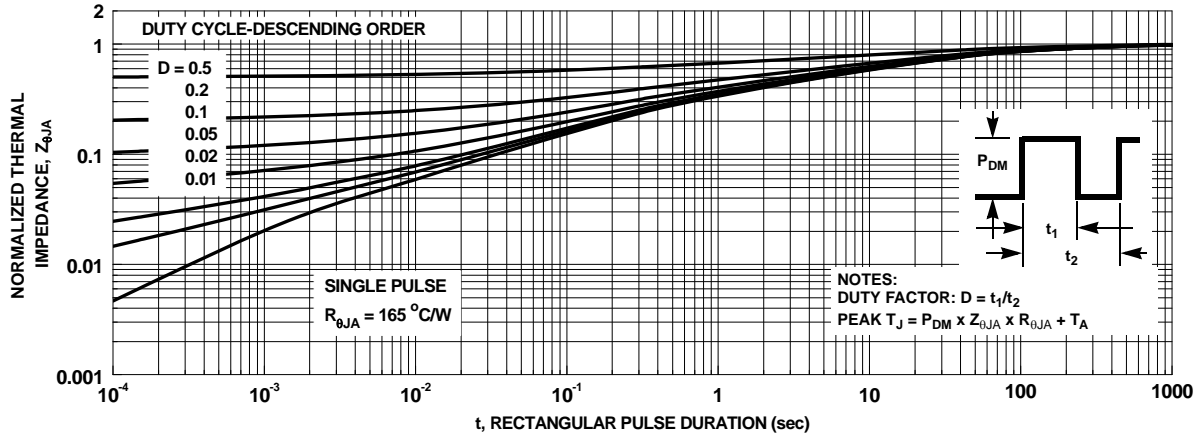
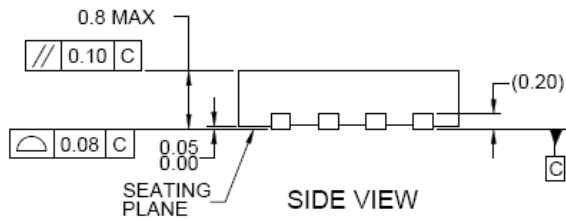
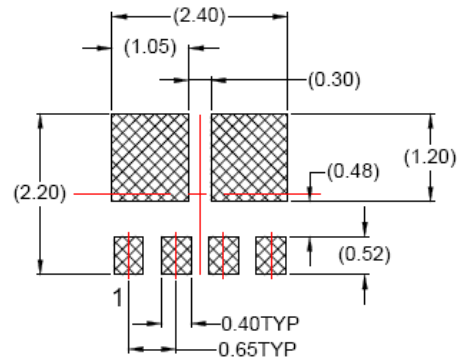
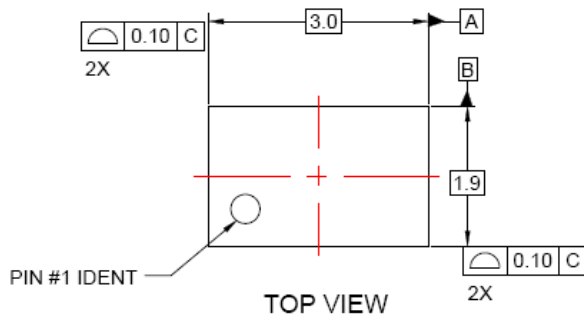

Figure 12. Junction-to-Ambient Transient Thermal Response Curve

Dimensional Outline and Pad Layout



NOTES:

- A. DOES NOT FULLY CONFORM TO JEDED REGISTRATION MO-229.
- B. DIMENSIONS ARE IN MILLIMETERS.
- C. DIMENSIONS AND TOLERANCES PER ASME Y14.5M, 2009.

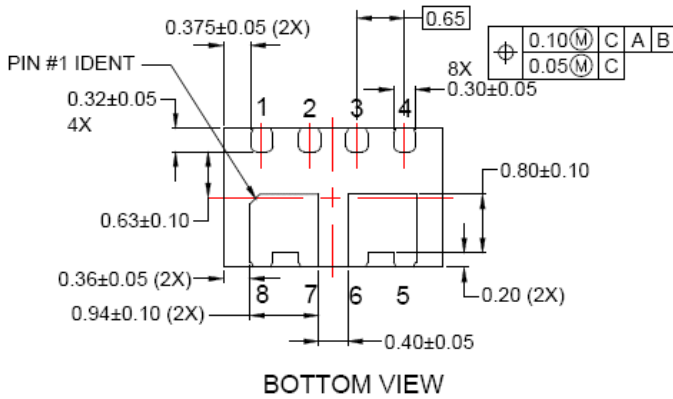



TRADEMARKS

The following includes registered and unregistered trademarks and service marks, owned by Fairchild Semiconductor and/or its global subsidiaries, and is not intended to be an exhaustive list of all such trademarks.

- | | | | |
|---|---|----------------------------|------------------|
| 2Cool™ | FPST™ | PowerTrench® | Sync-Lock™ |
| AccuPower™ | F-PFST™ | PowerXS™ | SYSTEM GENERAL®* |
| AX-CAP®* | FRFET® | Programmable Active Droop™ | TinyBoost™ |
| BitSiC™ | Global Power Resource SM | QFET® | TinyBuck™ |
| Build it Now™ | Green Bridge™ | QS™ | TinyCalc™ |
| CorePLUS™ | Green FPS™ | Quiet Series™ | TinyLogic® |
| CorePOWER™ | Green FPS™ e-Series™ | RapidConfigure™ | TINYOPTO™ |
| CROSSVOLT™ | Gmax™ | ™ | TinyPower™ |
| CTL™ | GTO™ | ™ | TinyPWM™ |
| Current Transfer Logic™ | IntelliMAX™ | ™ | TinyWire™ |
| DEUXPEED® | ISOPANAR™ | ™ | TranSiC® |
| Dual Cool™ | Marking Small Speakers Sound Louder and Better™ | ™ | TriFault Detect™ |
| EcoSPARK® | MegaBuck™ | ™ | TRUECURRENT®* |
| EfficientMax™ | MICROCOUPLER™ | ™ | µSerDes™ |
| ESBC™ | MicroFET™ | ™ | ™ |
|  | MicroPak™ | ™ | UHC® |
| Fairchild® | MicroPak2™ | ™ | Ultra FRFET™ |
| Fairchild Semiconductor® | MillerDrive™ | ™ | UniFET™ |
| FACT Quiet Series™ | MotionMax™ | ™ | VCX™ |
| FACT® | mWSaver™ | ™ | VisualMax™ |
| FAST® | OptoHiT™ | ™ | VoltagePlus™ |
| FastvCore™ | OPTOLOGIC® | ™ | XST™ |
| FETBench™ | OPTOPLANAR® | ™ | |

*Trademarks of System General Corporation, used under license by Fairchild Semiconductor.

DISCLAIMER

FAIRCHILD SEMICONDUCTOR RESERVES THE RIGHT TO MAKE CHANGES WITHOUT FURTHER NOTICE TO ANY PRODUCTS HEREIN TO IMPROVE RELIABILITY, FUNCTION, OR DESIGN. FAIRCHILD DOES NOT ASSUME ANY LIABILITY ARISING OUT OF THE APPLICATION OR USE OF ANY PRODUCT OR CIRCUIT DESCRIBED HEREIN; NEITHER DOES IT CONVEY ANY LICENSE UNDER ITS PATENT RIGHTS, NOR THE RIGHTS OF OTHERS. THESE SPECIFICATIONS DO NOT EXPAND THE TERMS OF FAIRCHILD'S WORLDWIDE TERMS AND CONDITIONS, SPECIFICALLY THE WARRANTY THEREIN, WHICH COVERS THESE PRODUCTS.

LIFE SUPPORT POLICY

FAIRCHILD'S PRODUCTS ARE NOT AUTHORIZED FOR USE AS CRITICAL COMPONENTS IN LIFE SUPPORT DEVICES OR SYSTEMS WITHOUT THE EXPRESS WRITTEN APPROVAL OF FAIRCHILD SEMICONDUCTOR CORPORATION.

As used here in:

- Life support devices or systems are devices or systems which, (a) are intended for surgical implant into the body or (b) support or sustain life, and (c) whose failure to perform when properly used in accordance with instructions for use provided in the labeling, can be reasonably expected to result in a significant injury of the user.
- A critical component in any component of a life support, device, or system whose failure to perform can be reasonably expected to cause the failure of the life support device or system, or to affect its safety or effectiveness.

ANTI-COUNTERFEITING POLICY

Fairchild Semiconductor Corporation's Anti-Counterfeiting Policy. Fairchild's Anti-Counterfeiting Policy is also stated on our external website, www.fairchildsemi.com, under Sales Support.

Counterfeiting of semiconductor parts is a growing problem in the industry. All manufactures of semiconductor products are experiencing counterfeiting of their parts. Customers who inadvertently purchase counterfeit parts experience many problems such as loss of brand reputation, substandard performance, failed application, and increased cost of production and manufacturing delays. Fairchild is taking strong measures to protect ourselves and our customers from the proliferation of counterfeit parts. Fairchild strongly encourages customers to purchase Fairchild parts either directly from Fairchild or from Authorized Fairchild Distributors who are listed by country on our web page cited above. Products customers buy either from Fairchild directly or from Authorized Fairchild Distributors are genuine parts, have full traceability, meet Fairchild's quality standards for handling and storage and provide access to Fairchild's full range of up-to-date technical and product information. Fairchild and our Authorized Distributors will stand behind all warranties and will appropriately address and warranty issues that may arise. Fairchild will not provide any warranty coverage or other assistance for parts bought from Unauthorized Sources. Fairchild is committed to combat this global problem and encourage our customers to do their part in stopping this practice by buying direct or from authorized distributors.

PRODUCT STATUS DEFINITIONS

Definition of Terms

Datasheet Identification	Product Status	Definition
Advance Information	Formative / In Design	Datasheet contains the design specifications for product development. Specifications may change in any manner without notice.
Preliminary	First Production	Datasheet contains preliminary data; supplementary data will be published at a later date. Fairchild Semiconductor reserves the right to make changes at any time without notice to improve design.
No Identification Needed	Full Production	Datasheet contains final specifications. Fairchild Semiconductor reserves the right to make changes at any time without notice to improve the design.
Obsolete	Not In Production	Datasheet contains specifications on a product that is discontinued by Fairchild Semiconductor. The datasheet is for reference information only.