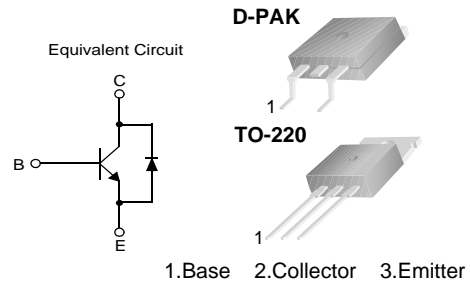


# KSC5402D/KSC5402DT

## NPN Silicon Transistor, Planar Silicon Transistor

### Features

- High Voltage High Speed Power Switch Application
- Wide Safe Operating Area
- Built-in Free Wheeling Diode
- Suitable for Electronic Ballast Application
- Small Variance in Storage Time
- Two Package Choices; D-PAK or TO-220



### Absolute Maximum Ratings $T_A=25^\circ\text{C}$ unless otherwise noted

Symbol	Parameter	Value	Units
$V_{CBO}$	Collector-Base Voltage	1000	V
$V_{CEO}$	Collector-Emitter Voltage	450	V
$V_{EBO}$	Emitter-Base Voltage	12	V
$I_C$	Collector Current (DC)	2	A
$I_{CP}$	*Collector Current (Pulse)	5	A
$I_B$	Base Current (DC)	1	A
$I_{BP}$	*Base Current (Pulse)	2	A
$P_C$	Power Dissipation( $T_C=25^\circ\text{C}$ ) : D-PAK* : TO-220	30 50	W W
$T_J$	Junction Temperature	150	$^\circ\text{C}$
$T_{STG}$	Storage Temperature	- 65 to 150	$^\circ\text{C}$

\* Pulse Test: Pulse Width=5ms, Duty Cycle $\leq$ 10%

### Thermal Characteristics $T_A=25^\circ\text{C}$ unless otherwise noted

Symbol	Parameter	Rating		Units	
		TO-220	D-PAK		
$R_{\theta JC}$	Thermal Resistance	Junction to Case	2.5	4.17*	$^\circ\text{C}/\text{W}$
$R_{\theta JA}$		Junction to Ambient	62.5	50	$^\circ\text{C}/\text{W}$
$T_L$	Maximum Lead Temperature for Soldering Purpose ; 1/8" from Case for 5 Seconds		270	270	$^\circ\text{C}$

\* Mounted on 1" square PCB (FR4 ro G-10 Material)

**Electrical Characteristics**  $T_A=25^\circ\text{C}$  unless otherwise noted

Symbol	Parameter	Test Condition	Min.	Typ.	Max.	Units
$BV_{CBO}$	Collector-Base Breakdown Voltage	$I_C=1\text{mA}, I_E=0$	1000	1090		V
$BV_{CEO}$	Collector-Emitter Breakdown Voltage	$I_C=5\text{mA}, I_B=0$	450	525		V
$BV_{EBO}$	Emitter-Base Breakdown Voltage	$I_E=1\text{mA}, I_C=0$	12	14		V
$I_{CES}$	Collector Cut-off Current	$V_{CES}=1000\text{V}, I_{EB}=0$	$T_A=25^\circ\text{C}$	0.03	100	$\mu\text{A}$
			$T_A=125^\circ\text{C}$	1.2	500	$\mu\text{A}$
$I_{CEO}$	Collector Cut-off Current	$V_{CE}=450\text{V}, V_B=0$	$T_A=25^\circ\text{C}$	0.3	100	$\mu\text{A}$
			$T_A=125^\circ\text{C}$	15	500	$\mu\text{A}$
$I_{EBO}$	Emitter Cut-off Current	$V_{EB}=10\text{V}, I_C=0$		0.01	100	$\mu\text{A}$
$h_{FE}$	DC Current Gain	$V_{CE}=1\text{V}, I_C=0.4\text{A}$	$T_A=25^\circ\text{C}$	14	29	
			$T_A=125^\circ\text{C}$	8	17	
		$V_{CE}=1\text{V}, I_C=1\text{A}$	$T_A=25^\circ\text{C}$	6	9	
			$T_A=125^\circ\text{C}$	4	6	
$V_{CE(sat)}$	Collector-Emitter Saturation Voltage	$I_C=0.4, I_B=0.04\text{A}$	$T_A=25^\circ\text{C}$	0.25	0.6	V
			$T_A=125^\circ\text{C}$	0.4	1.0	V
		$I_C=1\text{A}, I_B=0.2\text{A}$	$T_A=25^\circ\text{C}$	0.3	0.75	V
			$T_A=125^\circ\text{C}$	0.65	1.2	V
$V_{BE(sat)}$	Base-Emitter Saturation Voltage	$I_C=0.4\text{A}, I_B=0.04\text{A}$	$T_A=25^\circ\text{C}$	0.78	1.0	V
			$T_A=125^\circ\text{C}$	0.65	0.9	V
		$I_C=1\text{A}, I_B=0.2\text{A}$	$T_A=25^\circ\text{C}$	0.85	1.1	V
			$T_A=125^\circ\text{C}$	0.75	1.0	V
$C_{ib}$	Input Capacitance	$V_{EB}=8\text{V}, I_C=0, f=1\text{MHz}$		330	500	pF
$C_{ob}$	Output Capacitance	$V_{CB}=10\text{V}, I_E=0, f=1\text{MHz}$		35	100	pF
$f_T$	Current Gain Bandwidth Product	$I_C=0.5\text{A}, V_{CE}=10\text{V}$		11		MHz
$V_F$	Diode Forward Voltage	$I_F=1\text{A}$	$T_A=25^\circ\text{C}$	0.86	1.5	V
			$T_A=125^\circ\text{C}$	0.75	1.2	V
		$I_F=0.2\text{A}$	$T_A=25^\circ\text{C}$	0.6		V
			$T_A=125^\circ\text{C}$	0.8	1.3	V
		$I_F=0.4\text{A}$	$T_A=125^\circ\text{C}$	0.65		V

**Electrical Characteristics** (Continued)  $T_A=25^\circ\text{C}$  unless otherwise noted

Symbol	Parameter	Test Condition	Min.	Typ.	Max.	Units	
$t_{fr}$	Diode Forward Recovery Time ( $di/dt=10\text{A}/\mu\text{s}$ )	$I_F=0.2\text{A}$		540		ns	
		$I_F=0.4\text{A}$		520		ns	
		$I_F=1\text{A}$		480		ns	
$V_{CE(DSAT)}$	Dynamic Saturation Voltage	$I_C=0.4\text{A}, I_{B1}=40\text{mA}$ $V_{CC}=300\text{V}$	@ $1\mu\text{s}$	7.5		V	
			@ $3\mu\text{s}$	2.5		V	
		$I_C=1\text{A}, I_{B1}=200\text{mA}$ $V_{CC}=300$	@ $1\mu\text{s}$	11.5		V	
			@ $3\mu\text{s}$	1.5		V	
RESISTIVE LOAD SWITCHING (D.C $\leq 10\%$ , Pulse Width= $20\mu\text{s}$ )							
$t_{ON}$	Turn On Time	$I_C=1\text{A},$ $I_{B1}=200\text{mA},$ $I_{B2}=150\text{mA},$ $V_{CC}=300\text{V},$ $R_L = 300\Omega$	$T_A=25^\circ\text{C}$		110	150	ns
			$T_A=125^\circ\text{C}$		135		ns
$t_{OFF}$	Turn Off Time		$T_A=25^\circ\text{C}$	0.95		1.25	$\mu\text{s}$
			$T_A=125^\circ\text{C}$		1.4		$\mu\text{s}$
INDUCTIVE LOAD SWITCHING ( $V_{CC}=15\text{V}$ )							
$t_{STG}$	Storage Time	$I_C=0.4\text{A},$ $I_{B1}=40\text{mA},$ $I_{B2}=200\text{mA},$ $V_Z=300\text{V},$ $L_C=200\text{H}$	$T_A=25^\circ\text{C}$		0.56	0.65	$\mu\text{s}$
			$T_A=125^\circ\text{C}$		0.7		$\mu\text{s}$
$t_F$	Fall Time		$T_A=25^\circ\text{C}$		60	175	ns
			$T_A=125^\circ\text{C}$		75		ns
$t_C$	Cross-over Time		$T_A=25^\circ\text{C}$		90	175	ns
			$T_A=125^\circ\text{C}$		90		ns
$t_{STG}$	Storage Time	$I_C=0.8\text{A},$ $I_{B1}=160\text{mA},$ $I_{B2}=160\text{mA},$ $V_Z=300\text{V},$ $L_C=200\text{H}$	$T_A=25^\circ\text{C}$			2.75	$\mu\text{s}$
			$T_A=125^\circ\text{C}$		3		$\mu\text{s}$
$t_F$	Fall Time		$T_A=25^\circ\text{C}$		110	175	ns
			$T_A=125^\circ\text{C}$		180		ns
$t_C$	Cross-over Time		$T_A=25^\circ\text{C}$		125	350	ns
			$T_A=125^\circ\text{C}$		185		ns
$t_{STG}$	Storage Time	$I_C=1\text{A},$ $I_{B1}=200\text{mA},$ $I_{B2}=500\text{mA},$ $V_Z=300\text{V},$ $L_C=200\mu\text{H}$	$T_A=25^\circ\text{C}$		1.1	1.2	$\mu\text{s}$
			$T_A=125^\circ\text{C}$		1.35		$\mu\text{s}$
$t_F$	Fall Time		$T_A=25^\circ\text{C}$		105	150	ns
			$T_A=125^\circ\text{C}$		75		ns
$t_C$	Cross-over Time		$T_A=25^\circ\text{C}$		125	150	ns
			$T_A=125^\circ\text{C}$		100		ns

## Typical Performance Characteristics

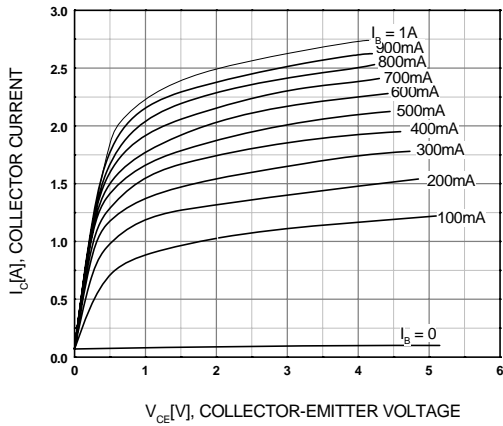


Figure 1. Static Characteristic

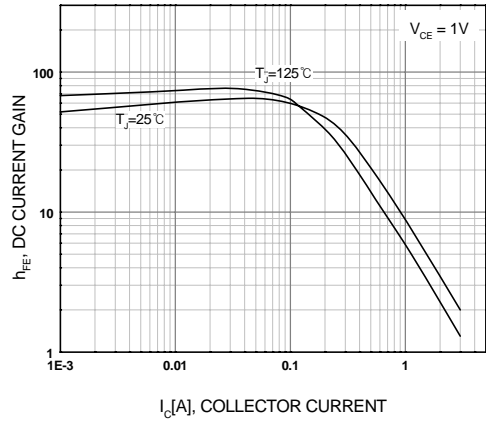


Figure 2. DC current Gain

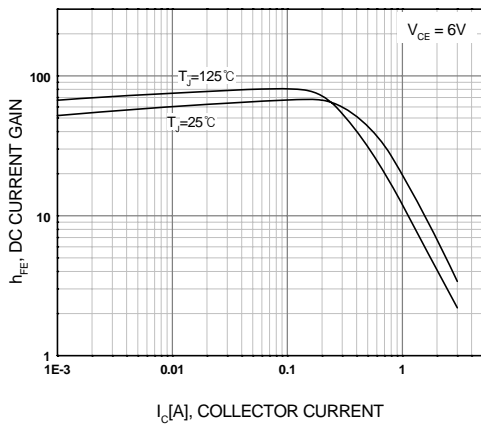


Figure 3. DC current Gain

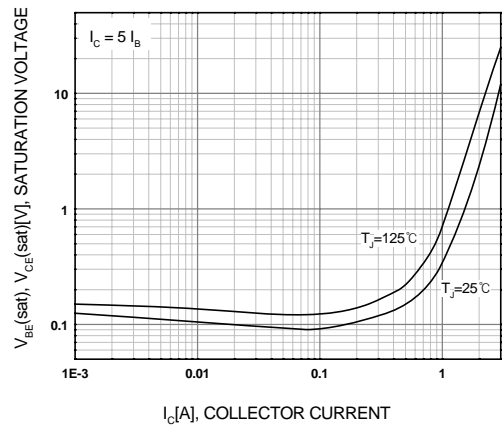


Figure 4. Collector-Emitter Saturation Voltage

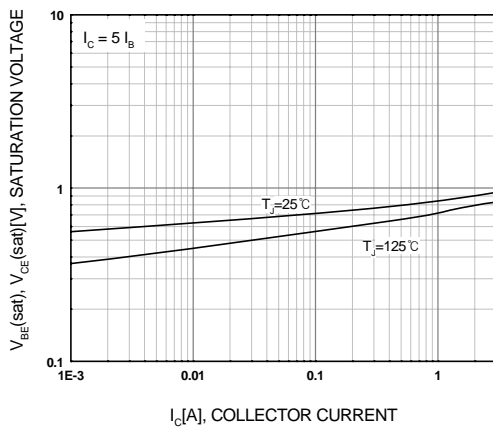


Figure 5. Base-Emitter Saturation Voltage

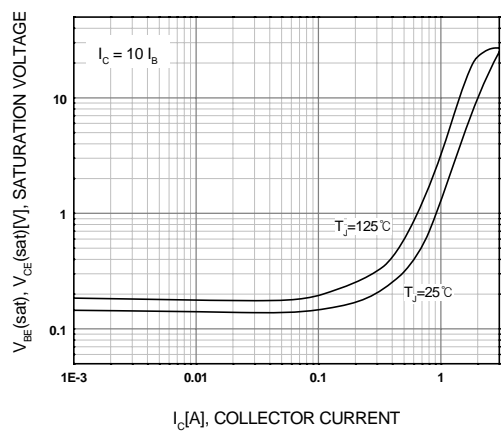
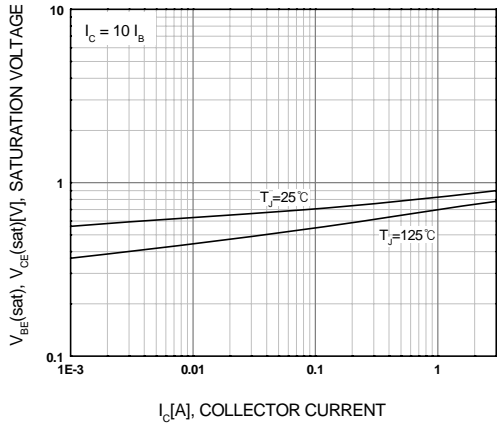
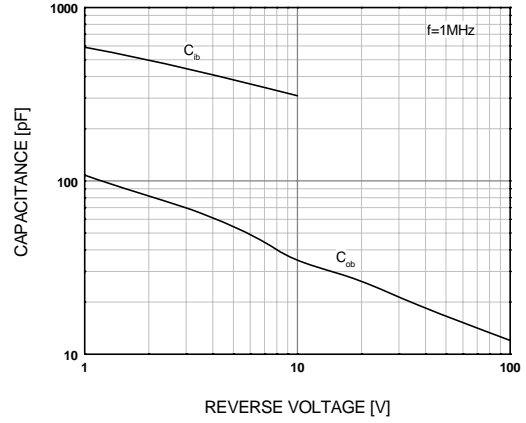


Figure 6. Collector-Emitter Saturation Voltage

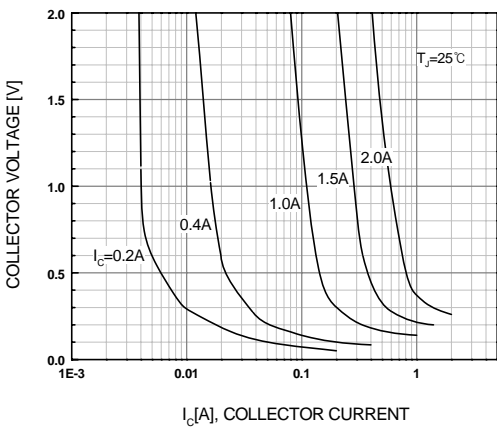
**Typical Performance Characteristics (Continued)**



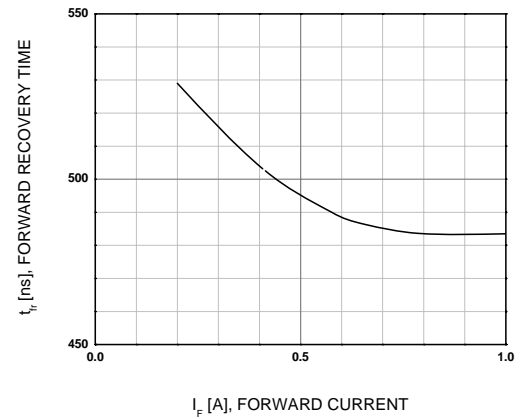
**Figure 7. Base-Emitter Saturation Voltage**



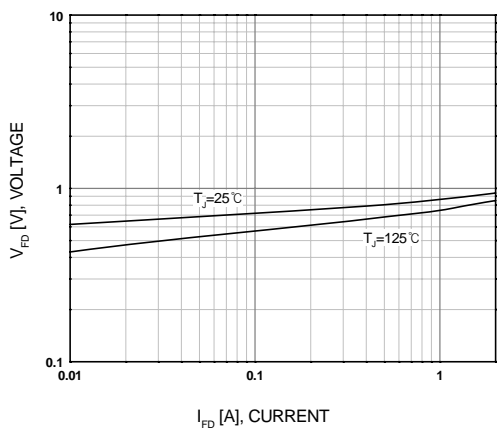
**Figure 8. Collector Output Capacitance**



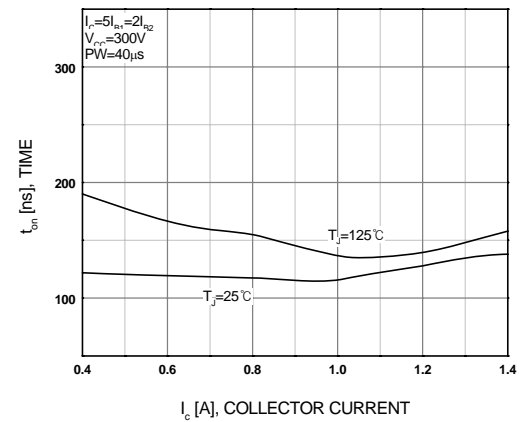
**Figure 9. Typical Collector Saturation Region**



**Figure 10. Forward Recovery Time**

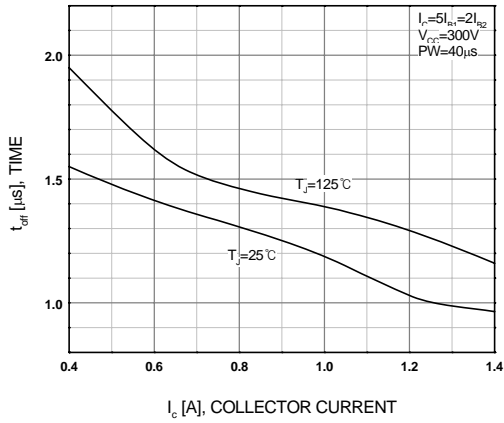


**Figure 11. Diode Forward Voltage**

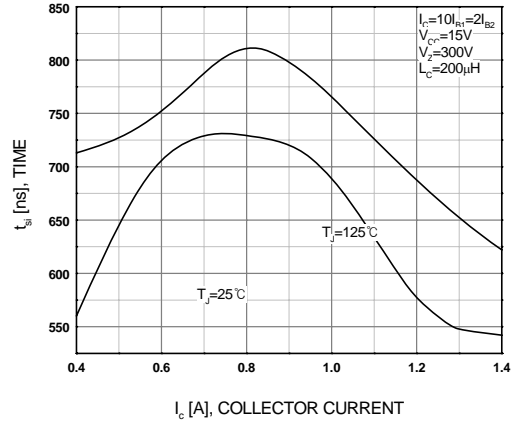


**Figure 12. Resistive Switching Time,  $t_{on}$**

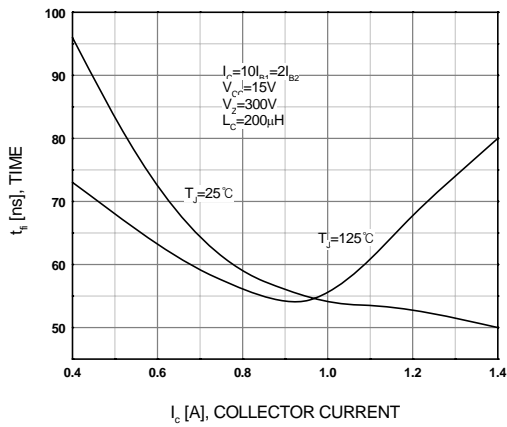
**Typical Performance Characteristics (Continued)**



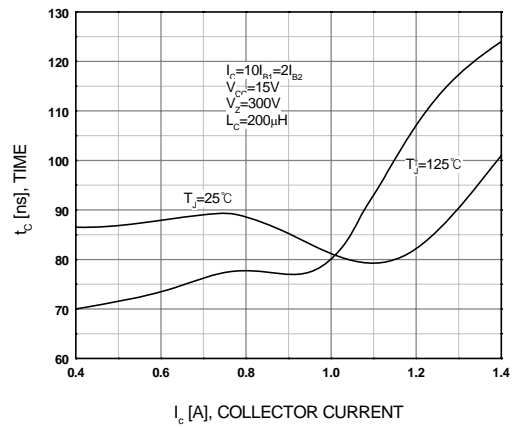
**Figure 13. Resistive Switching Time,  $t_{off}$**



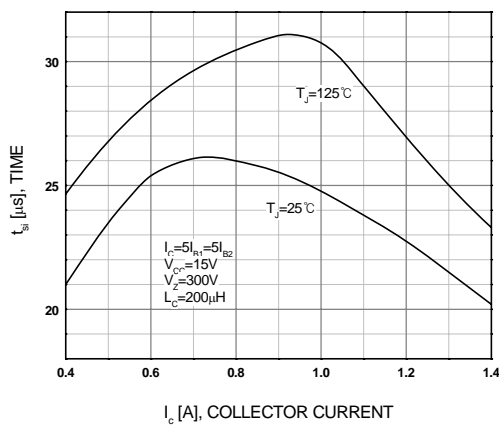
**Figure 14. Inductive Switching Time,  $t_{si}$**



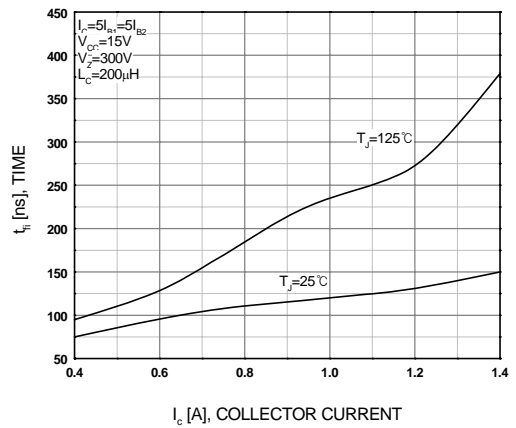
**Figure 15. Inductive Switching Time,  $t_{fi}$**



**Figure 16. Inductive Switching Time,  $t_c$**

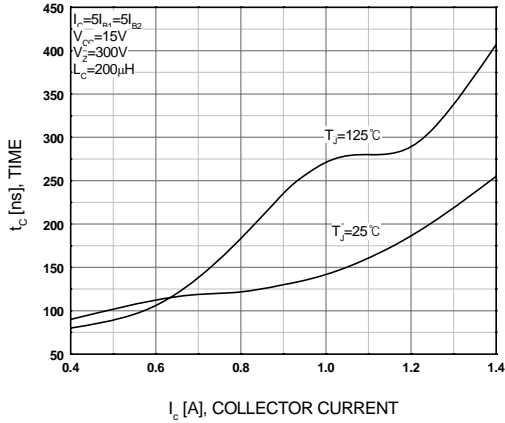


**Figure 17. Inductive Switching Time,  $t_{si}$**

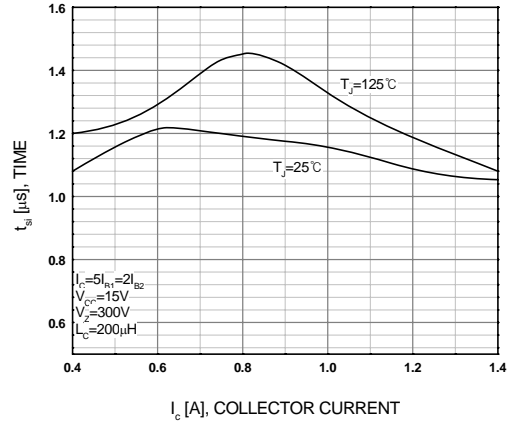


**Figure 18. Inductive Switching Time,  $t_{fi}$**

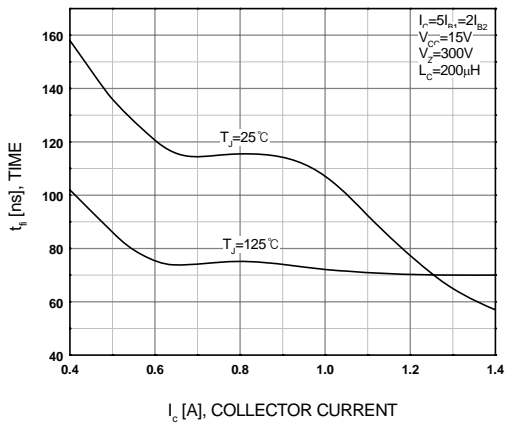
**Typical Performance Characteristics (Continued)**



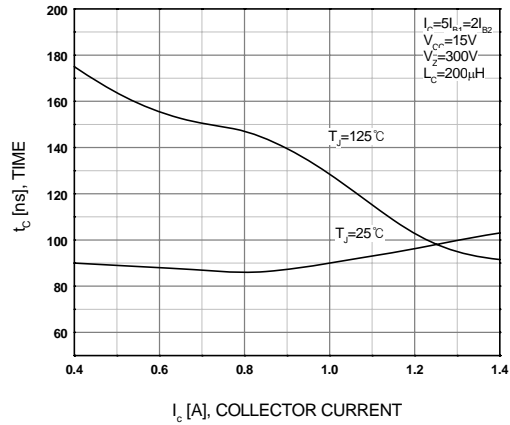
**Figure 19. Inductive Switching Time,  $t_c$**



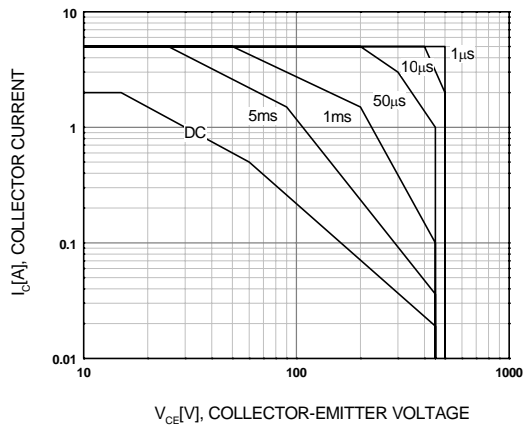
**Figure 20. Inductive Switching Time,  $t_{si}$**



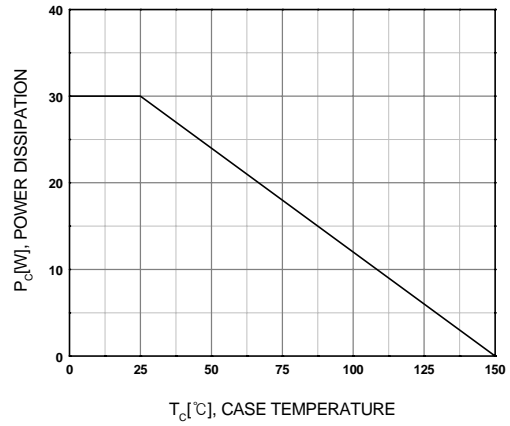
**Figure 21. Inductive Switching Time,  $t_{fi}$**



**Figure 22. Inductive Switching Time,  $t_c$**



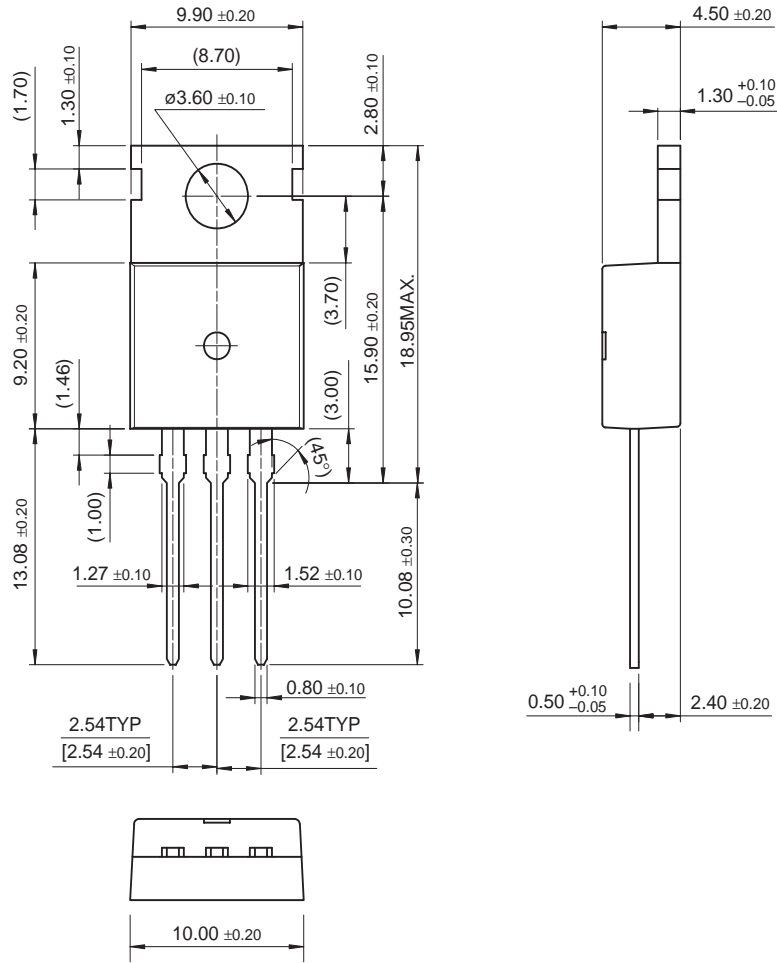
**Figure 23. Forward Bias Safe Operating Area**



**Figure 24. Power Derating**

Physical Dimension

TO-220

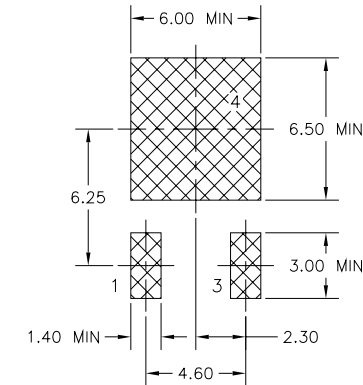
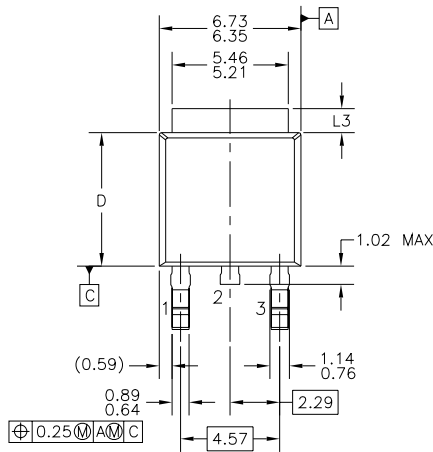


Dimensions in Millimeters

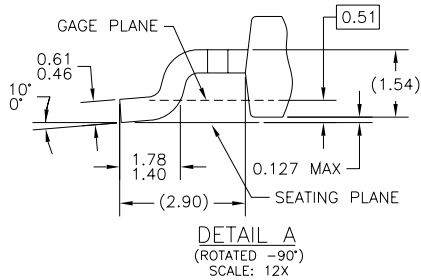
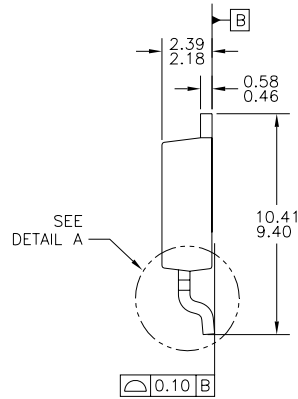
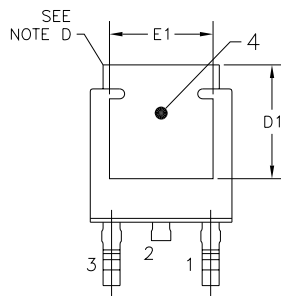


**Physical Dimension (Continued)**

**D-PAK**



LAND PATTERN RECOMMENDATION









- NOTES: UNLESS OTHERWISE SPECIFIED  
 A) ALL DIMENSIONS ARE IN MILLIMETERS.  
 B) THIS PACKAGE CONFORMS TO JEDEC, TO-252, ISSUE C, VARIATION AA & AB, DATED NOV. 1999.  
 C) DIMENSIONING AND TOLERANCING PER ASME Y14.5M-1994.  
 D) HEAT SINK TOP EDGE COULD BE IN CHAMFERED CORNERS OR EDGE PROTRUSION.  
 E) DIMENSIONS L3,D,E1&D1 TABLE:
- |    | OPTION AA | OPTION AB |
|----|-----------|-----------|
| L3 | 0.89-1.27 | 1.52-2.03 |
| D  | 5.97-6.22 | 5.33-5.59 |
| E1 | 4.32 MIN  | 3.81 MIN  |
| D1 | 5.21 MIN  | 4.57 MIN  |
- F) PRESENCE OF TRIMMED CENTER LEAD IS OPTIONAL.

Dimensions in Millimeters



**TRADEMARKS**

The following includes registered and unregistered trademarks and service marks, owned by Fairchild Semiconductor and/or its global subsidiaries, and is not intended to be an exhaustive list of all such trademarks.

AccuPower™	FPS™	PowerTrench®	The Power Franchise®
Auto-SPM™	F-PFS™	PowerXS™	the power franchise
Build it Now™	FRFET®	Programmable Active Droop™	TinyBoost™
CorePLUS™	Global Power Resource™	QFET®	TinyBuck™
CorePOWER™	Green FPS™	QS™	TinyCalc™
CROSSVOLT™	Green FPS™ e-Series™	Quiet Series™	TinyLogic®
CTL™	Gmax™	RapidConfigure™	TINYOPTO™
Current Transfer Logic™	GTO™		TinyPower™
EcoSPARK®	IntelliMAX™	Saving our world, 1mW/W/kW at a time™	TinyPwm™
EfficientMax™	ISOPLANAR™	SmartMax™	TinyWire™
EZSWITCH™*	MegaBuck™	SMART START™	TriFault Detect™
	MICROCOUPLER™	SPM®	TRUECURRENT™*
	MicroFET™	STEALTH™	µSerDes™
Fairchild®	MicroPak™	SuperFET™	
Fairchild Semiconductor®	MillerDrive™	SuperSOT™-3	UHC®
FACT Quiet Series™	MotionMax™	SuperSOT™-6	Ultra FRFET™
FACT®	Motion-SPM™	SuperSOT™-8	UniFET™
FAST®	OPTOLOGIC®	SupreMOS™	VCX™
FastvCore™	OPTOPLANAR®	SyncFET™	VisualMax™
FETBench™		Sync-Lock™	XS™
FlashWriter®*	PDP SPM™		
	Power-SPM™		

\* Trademarks of System General Corporation, used under license by Fairchild Semiconductor.

**DISCLAIMER**

FAIRCHILD SEMICONDUCTOR RESERVES THE RIGHT TO MAKE CHANGES WITHOUT FURTHER NOTICE TO ANY PRODUCTS HEREIN TO IMPROVE RELIABILITY, FUNCTION, OR DESIGN. FAIRCHILD DOES NOT ASSUME ANY LIABILITY ARISING OUT OF THE APPLICATION OR USE OF ANY PRODUCT OR CIRCUIT DESCRIBED HEREIN; NEITHER DOES IT CONVEY ANY LICENSE UNDER ITS PATENT RIGHTS, NOR THE RIGHTS OF OTHERS. THESE SPECIFICATIONS DO NOT EXPAND THE TERMS OF FAIRCHILD'S WORLDWIDE TERMS AND CONDITIONS, SPECIFICALLY THE WARRANTY THEREIN, WHICH COVERS THESE PRODUCTS.

**LIFE SUPPORT POLICY**

FAIRCHILD'S PRODUCTS ARE NOT AUTHORIZED FOR USE AS CRITICAL COMPONENTS IN LIFE SUPPORT DEVICES OR SYSTEMS WITHOUT THE EXPRESS WRITTEN APPROVAL OF FAIRCHILD SEMICONDUCTOR CORPORATION.

As used herein:

1. Life support devices or systems are devices or systems which, (a) are intended for surgical implant into the body or (b) support or sustain life, and (c) whose failure to perform when properly used in accordance with instructions for use provided in the labeling, can be reasonably expected to result in a significant injury of the user.
2. A critical component in any component of a life support, device, or system whose failure to perform can be reasonably expected to cause the failure of the life support device or system, or to affect its safety or effectiveness.

**ANTI-COUNTERFEITING POLICY**

Fairchild Semiconductor Corporation's Anti-Counterfeiting Policy. Fairchild's Anti-Counterfeiting Policy is also stated on our external website, [www.fairchildsemi.com](http://www.fairchildsemi.com), under Sales Support.

Counterfeiting of semiconductor parts is a growing problem in the industry. All manufacturers of semiconductor products are experiencing counterfeiting of their parts. Customers who inadvertently purchase counterfeit parts experience many problems such as loss of brand reputation, substandard performance, failed applications, and increased cost of production and manufacturing delays. Fairchild is taking strong measures to protect ourselves and our customers from the proliferation of counterfeit parts. Fairchild strongly encourages customers to purchase Fairchild parts either directly from Fairchild or from Authorized Fairchild Distributors who are listed by country on our web page cited above. Products customers buy either from Fairchild directly or from Authorized Fairchild Distributors are genuine parts, have full traceability, meet Fairchild's quality standards for handling and storage and provide access to Fairchild's full range of up-to-date technical and product information. Fairchild and our Authorized Distributors will stand behind all warranties and will appropriately address any warranty issues that may arise. Fairchild will not provide any warranty coverage or other assistance for parts bought from Unauthorized Sources. Fairchild is committed to combat this global problem and encourage our customers to do their part in stopping this practice by buying direct or from authorized distributors.

**PRODUCT STATUS DEFINITIONS**

**Definition of Terms**

Datasheet Identification	Product Status	Definition
Advance Information	Formative / In Design	Datasheet contains the design specifications for product development. Specifications may change in any manner without notice.
Preliminary	First Production	Datasheet contains preliminary data; supplementary data will be published at a later date. Fairchild Semiconductor reserves the right to make changes at any time without notice to improve design.
No Identification Needed	Full Production	Datasheet contains final specifications. Fairchild Semiconductor reserves the right to make changes at any time without notice to improve the design.
Obsolete	Not In Production	Datasheet contains specifications on a product that is discontinued by Fairchild Semiconductor. The datasheet is for reference information only.