







1500 W Surface Mount Transient Voltage Suppressor

<p style="text-align: center; font-weight: bold;">DO-214AB (SMC)</p> <div style="text-align: center; margin-top: 20px;">  </div>	<table style="width: 100%; border-collapse: collapse;"> <tr> <td style="text-align: center; width: 50%;">Voltage</td> <td style="text-align: center; width: 50%;">Power</td> </tr> <tr> <td style="text-align: center;">6.4 V to 231 V (Uni) 6.4 V to 231 V (Bid)</td> <td style="text-align: center;">1500 W /ms</td> </tr> </table> <div style="text-align: center; margin-top: 10px;">  </div> <hr/> <p>FEATURES</p> <ul style="list-style-type: none"> Low profile package Ideal for automated placement 1500 W peak pulse power capability with a 10/1000 μs waveform, repetitive rate (duty cycle): 0.01 % Excellent clamping capability Very fast response time Low incremental surge resistance Available in uni-directional and bi-directional Solder dip 260°C, 10s AEC-Q101 qualified Component in accordance to RoHS 2011/65/EU and WEEE 2002/96/EC Meets MSL level 1, per J-STD-020, LF maximum peak of 260° C <div style="text-align: right; margin-top: 10px;">     </div> <hr/> <p>MECHANICAL DATA</p> <ul style="list-style-type: none"> Case: DO-214AB (SMC). Epoxy meets UL 94V-0 flammability rating. Polarity: For unidirectional types color band denotes cathode end. No marking on bidirectional types. Terminals: Matte tin plated leads, solderable per MIL-STD-750 Method 2026, J-STD-002 and JESD22-B102. Consumer grade, meets JESD 201 class 1A whisker test. HE3 suffix for high reliability grade, meets JESD 201 class 2 whisker test. <hr/> <p>TYPICAL APPLICATIONS</p> <p>Used in sensitive electronics protection against voltage transients induced by inductive load switching and lighting on ICs, MOSFET, signal lines of sensor units for consumer, computer, industrial, automotive and telecommunication.</p>	Voltage	Power	6.4 V to 231 V (Uni) 6.4 V to 231 V (Bid)	1500 W /ms
Voltage	Power				
6.4 V to 231 V (Uni) 6.4 V to 231 V (Bid)	1500 W /ms				

Maximun Ratings and Electrical Characteristics at 25°C

P_{PPM}	Peak Pulse Power Dissipation with 10/1000 μ s exponential pulse	1500 W
I_{FSM}	Peak Forward Surge Current 8.3 ms. (Note 1) (Jedec Method) (Note 2)	200 A
V_F	Max. forward voltage drop at $I_F = 100$ A (Note 1)	3.5 V
$T_J - T_{STG}$	Operating Junction and Storage Temperature Range	- 65 to + 150 °C
R_{thjA}	Typical thermal resistance, junction to ambient air	75° C/W
R_{thjL}	Typical thermal resistance, junction to lead	15° C/W

Notes: 1. Only for Unidirectional
 2. Mounted on 0.31 x 0.31" (8.0 x 8.0 mm) copper pads to each terminal

1500 W Surface Mount Transient Voltage Suppressor

Ordering information

PREFERRED P/N	PACKAGE CODE	DELIVERY MODE	BASE QUANTITY	UNIT WEIGHT (g)
1.5SMCJ26A TRTB	TRTB	13" diameter tape and reel	3,500	0.201
1.5SMCJ26A HE3 TRTB	TRTB	13" diameter tape and reel	3,500	0.201
1.5SMCJ36CA TRTB	TRTB	13" diameter tape and reel	3,500	0.201
1.5SMCJ36CA HE3 TRTB	TRTB	13" diameter tape and reel	3,500	0.201

Package Outline Dimensions: (mm) DO-214AB (SMC)

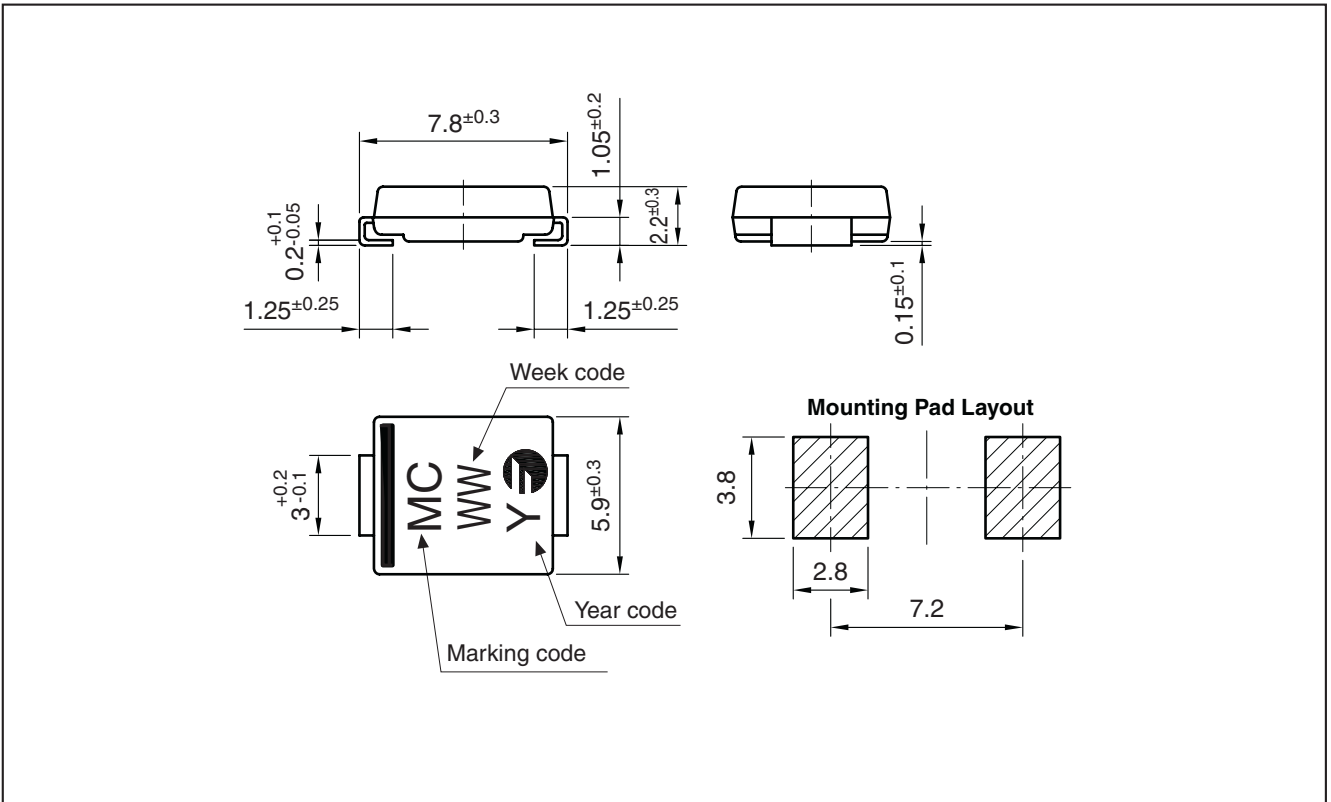

1500 W Surface Mount Transient Voltage Suppressor

Ratings and Characteristics (Ta 25 °C unless otherwise noted)

TYPE		DEVICE MARKING CODE		BREAKDOWN VOLTAGE V _{BR} AT I _T (1) (V)		TEST CURRENT I _T (mA)	STAND-OFF VOLTAGE V _{WM} (V)	MAXIMUM REVERSE LEAKAGE AT V _{WM} I _D (μA) (3)	MAXIMUM PEAK PULSE SURGE CURRENT I _{PPM} (A) (2)	MAXIMUM CLAMPING VOLTAGE AT I _{PPM} V _C (V)
UNI	BI	UNI	BI	MIN.	MAX.					
1.5SMCJ5.0A	CA(4)	UEA	UFR	6.40	7.07	10	5.0	1000	163.0	9.2
1.5SMCJ6.0A	CA	UEB	UFS	6.67	7.37	10	6.0	1000	145.6	10.3
1.5SMCJ6.5A	CA	UDW	UFT	7.22	7.98	10	6.5	500	133.9	11.2
1.5SMCJ7.0A	CA	UEC	UFU	7.78	8.60	10	7.0	200	125.0	12.0
1.5SMCJ7.5A	CA	UED	UFV	8.33	9.21	1.0	7.5	100	116.3	12.9
1.5SMCJ8.0A	CA	UEE	UFW	8.89	9.83	1.0	8.0	50	110.3	13.6
1.5SMCJ8.5A	CA	UEF	UFX	9.44	10.4	1.0	8.5	20	104.2	14.4
1.5SMCJ9.0A	CA	UEG	UFY	10.0	11.1	1.0	9.0	10	97.4	15.4
1.5SMCJ10A	CA	UEH	UFZ	11.1	12.3	1.0	10	5.0	88.2	17.0
1.5SMCJ11A	CA	UEI	UGA	12.2	13.5	1.0	11	5.0	82.4	18.2
1.5SMCJ12A	CA	UDX	UGB	13.3	14.7	1.0	12	5.0	75.4	19.9
1.5SMCJ13A	CA	UEJ	UGC	14.4	15.9	1.0	13	1.0	69.8	21.5
1.5SMCJ14A	CA	UEK	UGD	15.6	17.2	1.0	14	1.0	64.7	23.2
1.5SMCJ15A	CA	UEL	UGE	16.7	18.5	1.0	15	1.0	61.5	24.4
1.5SMCJ16A	CA	UEM	UGF	17.8	19.7	1.0	16	1.0	57.7	26.0
1.5SMCJ17A	CA	UEN	UGG	18.9	20.9	1.0	17	1.0	54.3	27.6
1.5SMCJ18A	CA	UEO	UGH	20.0	22.1	1.0	18	1.0	51.4	29.2
1.5SMCJ20A	CA	UEP	UGI	22.2	24.5	1.0	20	1.0	46.3	32.4
1.5SMCJ22A	CA	UEQ	UGK	24.4	26.9	1.0	22	1.0	42.3	35.5
1.5SMCJ24A	CA	UER	UGL	26.7	29.5	1.0	24	1.0	38.6	38.9
1.5SMCJ26A	CA	UDO	UGM	28.9	31.9	1.0	26	1.0	35.6	42.1
1.5SMCJ28A	CA	UES	UGN	31.1	34.4	1.0	28	1.0	33.0	45.4
1.5SMCJ30A	CA	UET	UGO	33.3	36.8	1.0	30	1.0	31.0	48.4
1.5SMCJ33A	CA	UEU	UGP	36.7	40.6	1.0	33	1.0	28.1	53.3
1.5SMCJ36A	CA	UEV	UDY	40.0	44.2	1.0	36	1.0	25.8	58.1
1.5SMCJ40A	CA	UEW	UGQ	44.4	49.1	1.0	40	1.0	23.3	64.5
1.5SMCJ43A	CA	UEX	UGR	47.8	52.8	1.0	43	1.0	21.6	69.4
1.5SMCJ45A	CA	UEY	UGS	50.0	55.3	1.0	45	1.0	20.6	72.7
1.5SMCJ48A	CA	UEZ	UGT	53.3	58.9	1.0	48	1.0	19.4	77.4
1.5SMCJ51A	CA	UFA	UGU	56.7	62.7	1.0	51	1.0	18.2	82.4
1.5SMCJ54A	CA	UDP	UGV	60.0	66.3	1.0	54	1.0	17.2	87.1
1.5SMCJ58A	CA	UFB	UGW	64.4	71.2	1.0	58	1.0	16.0	93.6
1.5SMCJ60A	CA	UFC	UGX	66.7	73.7	1.0	60	1.0	15.5	96.8
1.5SMCJ64A	CA	UFD	UGY	71.1	78.6	1.0	64	1.0	14.6	103
1.5SMCJ70A	CA	UFE	UGZ	77.8	86.0	1.0	70	1.0	13.3	113
1.5SMCJ75A	CA	UFF	UHA	83.3	92.1	1.0	75	1.0	12.4	121
1.5SMCJ78A	CA	UFG	UHB	86.7	95.8	1.0	78	1.0	11.9	126
1.5SMCJ85A	CA	UFH	UHC	94.4	104	1.0	85	1.0	10.9	137
1.5SMCJ90A	CA	UFI	UHD	100	111	1.0	90	1.0	10.3	146
1.5SMCJ100A	CA	UFJ	UHE	111	123	1.0	100	1.0	9.3	162
1.5SMCJ110A	CA	UFK	UHF	122	135	1.0	110	1.0	8.5	177
1.5SMCJ120A	CA	UFL	UHG	133	147	1.0	120	1.0	7.8	193
1.5SMCJ130A	CA	UFM	UHH	144	159	1.0	130	1.0	7.2	209
1.5SMCJ150A	CA	UFN	UHI	167	185	1.0	150	1.0	6.2	243
1.5SMCJ160A	CA	UFO	UHI	178	197	1.0	160	1.0	5.8	259
1.5SMCJ170A	CA	UFP	UHK	189	209	1.0	170	1.0	5.5	275
1.5SMCJ188A	CA	UFQ	UHL	209	231	1.0	188	1.0	4.6	328

Notes

- (1) Pulse test: $t_p \leq 50$ ms
- (2) Surge current waveform per fig. 3 and derate per fig. 2
- (3) For bi-directional types having V_{WM} of 10 V and less, the I_D limit is doubled
- (4) For the bi-directional SMCJ5.0CA, the maximum V_{BR} is 7.25 V

1500 W Surface Mount Transient Voltage Suppressor

Ratings and Characteristics (Ta 25 °C unless otherwise noted)

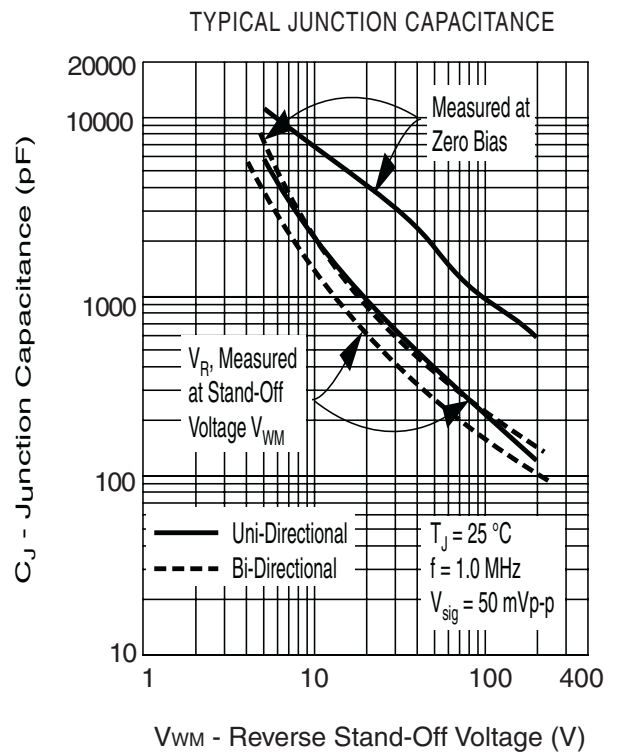
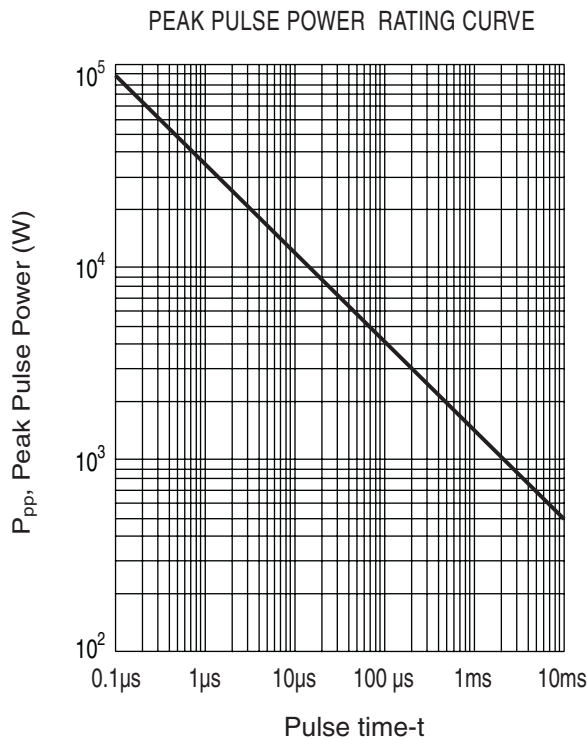
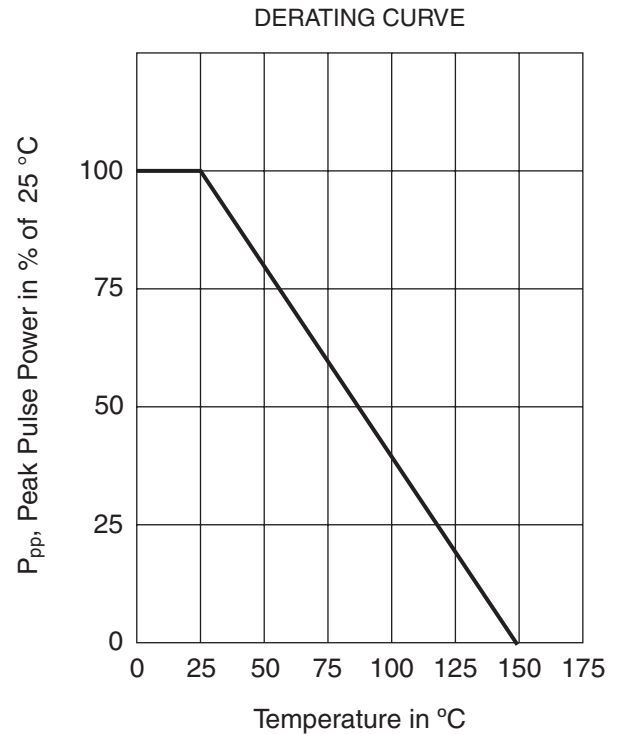
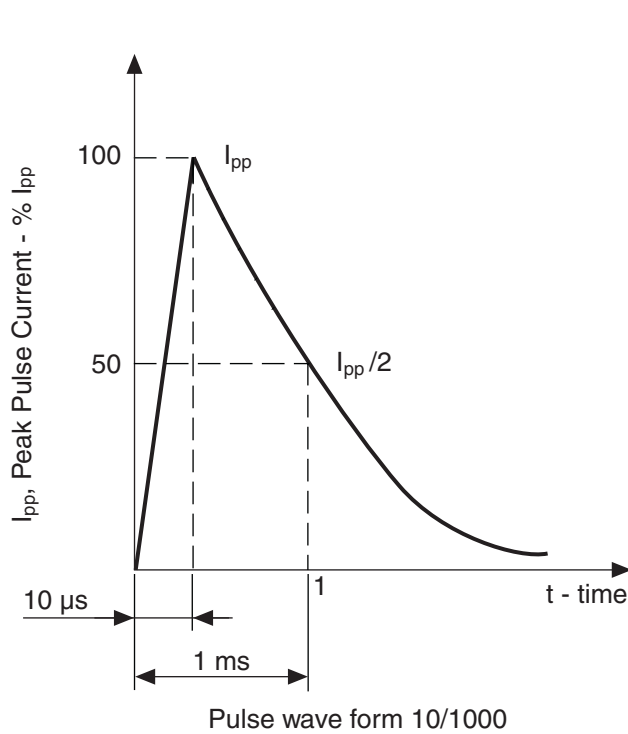

1500 W Surface Mount Transient Voltage Suppressor**Revision History**

Date	Revision	Description of Changes
14-Apr-2006	0	Original Data Sheet
7-Mar-2013	1	Reference included: Unidirectional & Bidirectional.

Disclaimer

All product, product specifications and data are subject to change without notice to improve reliability, function or design or otherwise.

Fagor Electrónica, S.Coop., its affiliates, agents, and employees, and all persons acting on its or their behalf (collectively, "Fagor"), disclaim any and all liability for any errors, inaccuracies or incompleteness contained in any datasheet or in any other disclosure relating to any product.

Fagor makes no warranty, representation or guarantee regarding the suitability of the products for any particular purpose or the continuing production of any product. To the maximum extent permitted by applicable law, Fagor disclaims (i) any and all liability arising out of the application or use of any product, (ii) any and all liability, including without limitation special, consequential or incidental damages, and (iii) any and all implied warranties, including warranties of fitness for particular purpose, non-infringement and merchantability.

Statements regarding the suitability of products for certain types of applications are based on Fagor's knowledge of typical requirements that are often placed on Fagor products in generic applications. Such statements are not binding statements about the suitability of products for a particular application. It is the customer's responsibility to validate that a particular product with the properties described in the product specification is suitable for use in a particular application. Parameters provided in datasheets and/or specifications may vary in different applications and performance may vary over time. All operating parameters, including typical parameters, must be validated for each customer application by the customer's technical experts. Product specifications do not expand or otherwise modify Fagor's terms and conditions of purchase, including but not limited to the warranty expressed therein.

Except as expressly indicated in writing, Fagor products are not designed for use in medical, life-saving, or life-sustaining applications or for any other application in which the failure of the Fagor product could result in personal injury or death. Customers using or selling Fagor products not expressly indicated for use in such applications do so at their own risk and agree to fully indemnify and hold Fagor and its distributors harmless from and against any and all claims, liabilities, expenses and damages arising or resulting in connection with such use or sale, including attorneys fees, even if such claim alleges that Fagor or its distributor was negligent regarding the design or manufacture of the part. Please contact authorized Fagor personnel to obtain written terms and conditions regarding products designed for such applications.

No license, express or implied, by estoppel or otherwise, to any intellectual property rights is granted by this document or by any conduct of Fagor, Product names and markings noted herein may be trademarks of their respective owners.