

### SMD ■ REFLECTOR 67-21/GBC-YV2W2N/2T



#### Features

- P-LCC-2 package.
- White package.
- Optical indicator.
- Colorless clear window.
- Wide viewing angle.
- Suitable for vapor-phase reflow, Infrared reflow and wave solder processes.
- Computable with automatic placement equipment.
- Available on tape and reel (8mm Tape).
- Pb-free
- The product itself will remain within RoHS compliant version

#### Descriptions

- The 67-21 series is available in soft orange, green, blue and yellow. Due to the package design, the LED has wide viewing angle and optimized light coupling by inter reflector. This feature makes TOP LED ideal for light pipe application. The low current requirement makes this device ideal for portable equipment or any other application where power is at a premium.

#### Applications

- Automotive: backlighting in dashboard and switch.
- Telecommunication: indicator and backlighting in telephone and fax.
- Flat backlight for LCD, switch and symbol.
- Light pipe application.
- General use.

## Device Selection Guide

Chip Materials	Emitted Color	Resin Color
InGaN/SiC	Brilliant Green	Water Clear

## Absolute Maximum Ratings (Ta=25°C)

Parameter	Symbol	Rating	Unit
Reverse Voltage	$V_R$	5	V
Forward Current	$I_F$	30	mA
Peak Forward Current (Duty 1/10 @1KHz)	$I_{FP}$	100	mA
Power Dissipation	$P_d$	110	mW
Electrostatic Discharge (HBM)	ESD	1000	V
Operating Temperature	$T_{opr}$	-40 ~ +85	°C
Storage Temperature	$T_{stg}$	-40 ~ +90	°C
Soldering Temperature	$T_{sol}$	Reflow Soldering : 260 °C for 30 sec. Hand Soldering : 350 °C for 3 sec.	

Parameter	Symbol	Min.	Typ.	Max.	Unit	Condition
Luminous Intensity	$I_v$	900	-----	1800	mcd	$I_F=20mA$
Viewing Angle	$2\theta_{1/2}$	-----	120	-----	deg	$I_F=20mA$
Peak Wavelength	$\lambda_p$	-----	518	-----	nm	$I_F=20mA$
Dominant Wavelength	$\lambda_d$	520	----	535	nm	$I_F=20mA$
Spectrum Radiation Bandwidth	$\Delta\lambda$	-----	35	-----	nm	$I_F=20mA$
Forward Voltage	$V_F$	2.7	----	3.7	V	$I_F=20mA$
Reverse Current	$I_R$	-----	-----	50	$\mu A$	$V_R=5V$

Note:

1. Tolerance of Luminous Intensity:  $\pm 11\%$
2. Tolerance of Dominant Wavelength:  $\pm 1nm$
3. Tolerance of Forward Voltage:  $\pm 0.1V$

### Bin Range of Luminous Intensity

Bin Code	Min.	Max.	Unit	Condition
V2	900	1120	mcd	I <sub>F</sub> =20mA
W1	1120	1420		
W2	1420	1800		

Note:  
 Tolerance of Luminous Intensity: ±11%

### Bin Range of Dominant Wavelength

Bin Code	Min.	Max.	Unit	Condition
X	520	525	nm	I <sub>F</sub> =20mA
Y	525	530		
Z	530	535		

Note:  
 Tolerance of Dominant Wavelength: ±1nm

### Bin Range of Forward Voltage

Bin Code	Min.	Max.	Unit	Condition
10	2.70	2.90	V	IF=20mA
11	2.90	3.10		
12	3.10	3.30		
13	3.30	3.50		
14	3.50	3.70		

Note:  
 Tolerance of Forward Voltage : ±0.1V

Typical Electro-Optical Characteristics

Spectrum Distribution

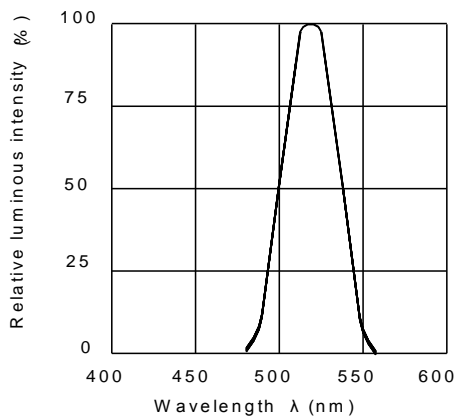

Forward Current vs. Forward Voltage

Ta=25°C

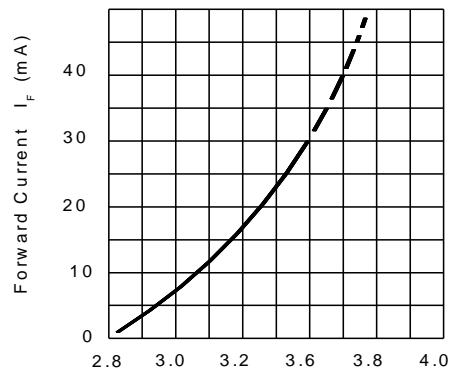

Forward Voltage (V\_F) -volts

Relative Luminous Intensity vs. Ambient Temperature

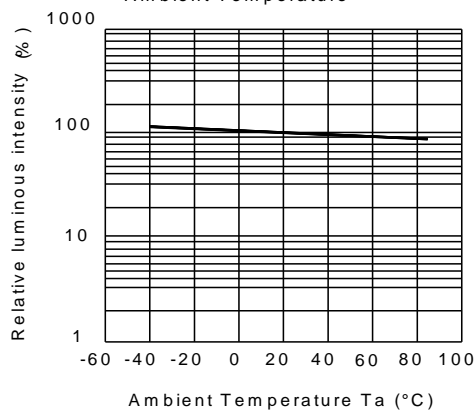

Relative Luminous Intensity vs Forward Current

Ta=25°C

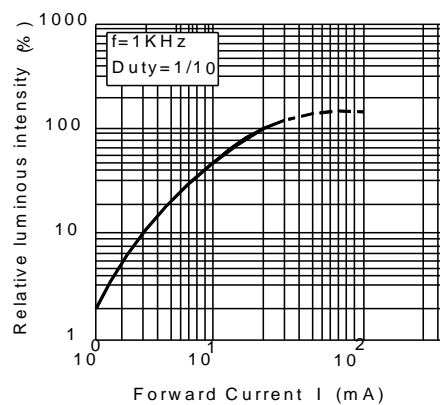

Radiation Diagram

0° 10° 20° Ta=25°C

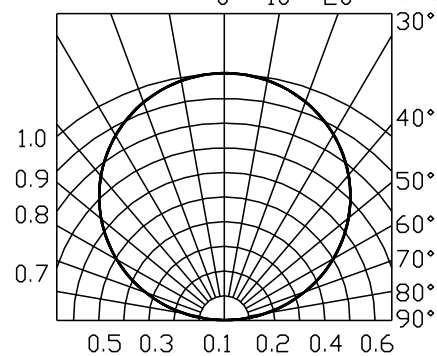

Forward Current Derating Curve

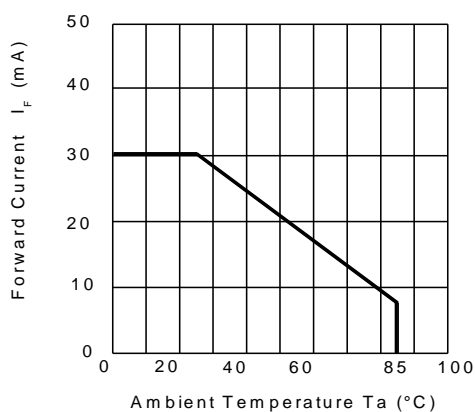

## Package Dimensions

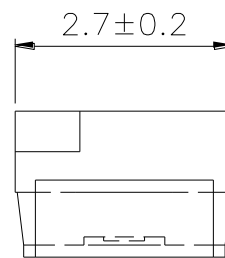
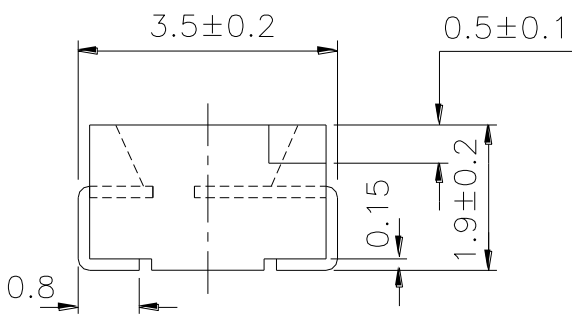
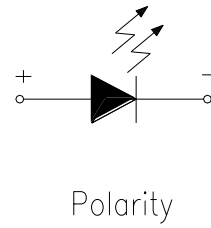
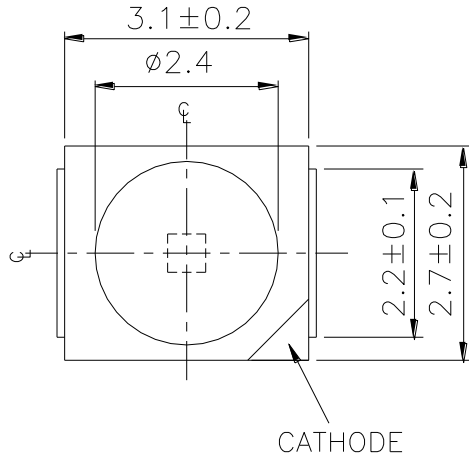

For reflow soldering (Proposal)

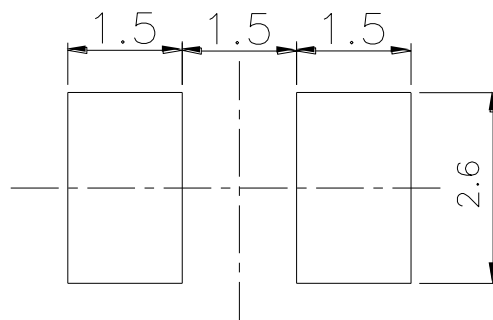
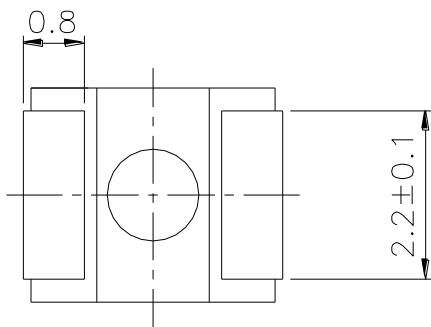

**Moisture Resistant Packing Materials**

CAT: Luminous Intensity Rank  
 HUE: Dom. Wavelength Rank  
 REF: Forward Voltage Rank  
 Label Explanation  
 CAT: Luminous Intensity Rank  
 HUE: Dom. Wavelength Rank  
 REF: Forward Voltage Rank



**Reel Dimensions**

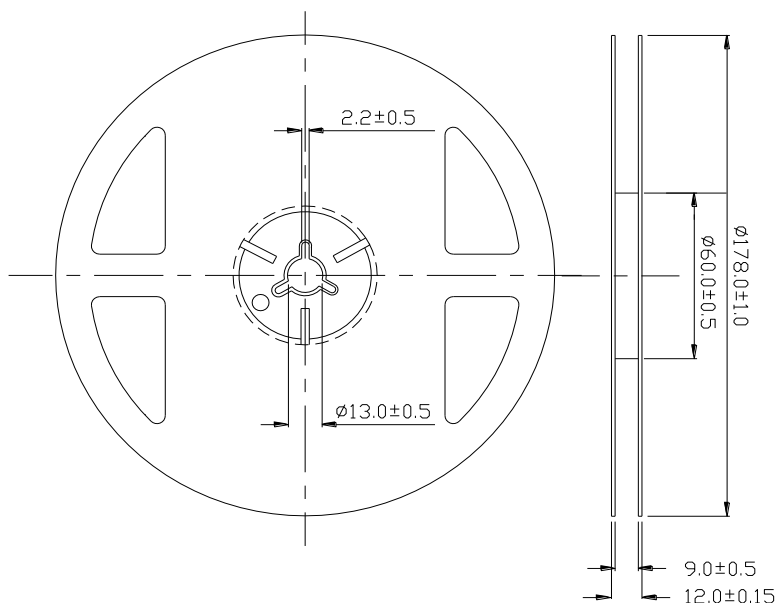

Note: The tolerances unless mentioned is  $\pm 0.1\text{mm}$ , Unit = mm

### Carrier Tape Dimensions: Loaded Quantity 2000 pcs Per Reel.

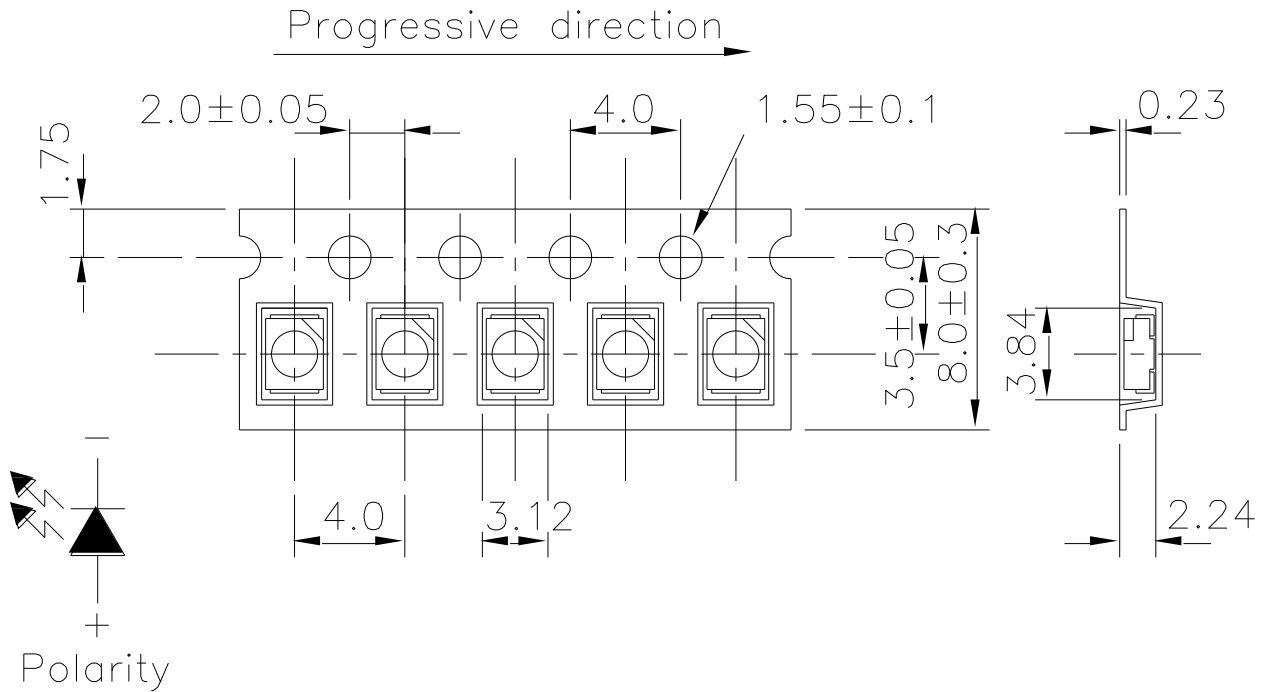

Note: The tolerances unless mentioned is  $\pm 0.1$ mm; Unit = mm

### Moisture Resistant Packaging

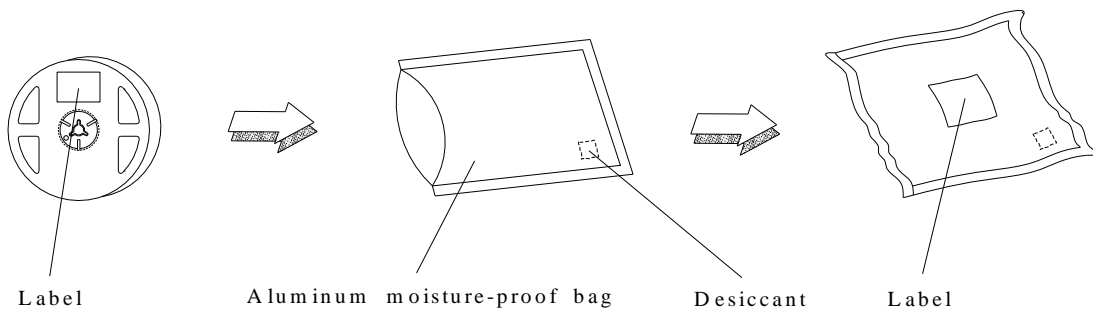

## Reliability Test Items and Conditions

The reliability of products shall be satisfied with items listed below.

Confidence level : 90%

LTPD : 10%

No.	Items	Test Condition	Test Hours/Cycles	Sample Size	Ac/Re
1	Reflow Soldering	Temp. : 260°C±5°C Min. 5sec.	6 Min.	22 PCS.	0/1
2	Temperature Cycle	H : +100°C 15min ↓ 5 min L : -40°C 15min	300 Cycles	22 PCS.	0/1
3	Thermal Shock	H : +100°C 5min ↓ 10 sec L : -10°C 5min	300 Cycles	22 PCS.	0/1
4	High Temperature Storage	Temp. : 100°C	1000 Hrs.	22 PCS.	0/1
5	Low Temperature Storage	Temp. : -40°C	1000 Hrs.	22 PCS.	0/1
6	DC Operating Life	IF = 20 mA	1000 Hrs.	22 PCS.	0/1
7	High Temperature / Humidity	High 85°C/ 85%RH	1000 Hrs.	22 PCS.	0/1

## Precautions for Use

### 1. Over-current-proof

Customer must apply resistors for protection, otherwise slight voltage shift will cause big current change ( Burn out will happen ).

### 2. Storage

2.1 Do not open moisture proof bag before the products are ready to use.

2.2 Before opening the package: The LEDs should be kept at 30°C or less and 90%RH or less.

2.3 After opening the package: The LED's floor life are 168 hours under 30°C or less and 60% RH or less. If unused LEDs remain, it should be stored in moisture proof packages.

2.4 If the moisture absorbent material (silica gel) has faded away or the LEDs have exceeded the storage time, baking treatment should be performed using the following conditions.

Baking treatment : 60±5°C for 24 hours.

### 3. Soldering Condition

#### 3.1 Pb-free solder temperature profile

3

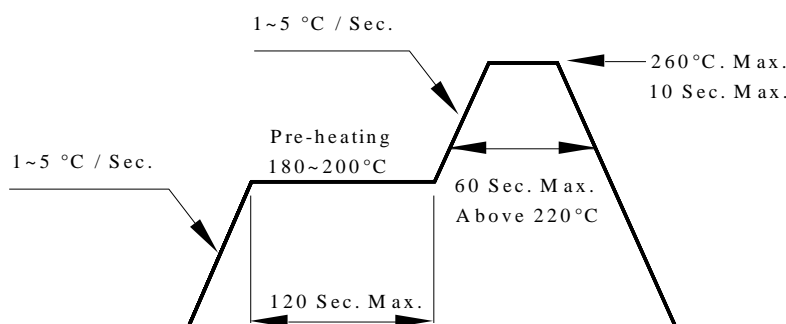



- 3.2 Reflow soldering should not be done more than two times.
- 3.3 When soldering, do not put stress on the LEDs during heating.
- 3.4 After soldering, do not warp the circuit board.

#### 4. Soldering Iron

Each terminal is to go to the tip of soldering iron temperature less than 350°C for 3 seconds within once in less than the soldering iron capacity 25W. Leave two seconds and more intervals, and do soldering of each terminal. Be careful because the damage of the product is often started at the time of the hand solder.

#### 5. Repairing

Repair should not be done after the LEDs have been soldered. When repairing is unavoidable, a double-head soldering iron should be used (as below figure). It should be confirmed beforehand whether the characteristics of the LEDs will or will not be damaged by repairing.

