

# EAUVA35352

## 1.8W Series



### Introduction

The EAUVA35352 product series is a ceramic based LED with high quality and reliability that suitable for UV application.

### Features

- ◆ Low power UVA LED
- ◆ Dimension 3.5mm\*3.5mm\*2.35mm
- ◆ ESD protection up to 8KV
- ◆ RoHS compliant
- ◆ Pb free
- ◆ EU REACH compliant
- ◆ Halogen Free compliant
- ◆ (Br<900ppm,Cl<900ppm,Br+Cl<1500ppm)

### Applications

- ◆ UV Sterilization System
- ◆ UV Photo-catalyst
- ◆ UV Sensor Light

## Product Nomenclature

### EAUVA35352XXY

EA = Everlight Americas

UVA = UVA

3535 = 3.5mm x 3.5mm Package

2 = Angle: 120°

XX = Wavelength Range [1]

Y = Minimum Radiant Flux Spec [2]

#### Notes:

##### 1. Wavelength Range

Symbol	Description
BC	360~370nm
EF	380~390nm
GH	390~400nm
IJ	400~410nm

##### 2. Minimum Radiant Flux Spec

Symbol	Description
8	1000mW

## Absolute Maximum Ratings

Parameter	Symbol	Ratings	Unit
Max. DC Forward Current (mA)	$I_F$	700	mA
Max. ESD Resistance	$V_B$	8000	V
Max. Junction Temperature	$T_J$	95	°C
Operating Temperature	$T_{Opr}$	-40 ~ +85	°C
Storage Temperature	$T_{Stg}$	-40 ~ +85	°C

## PN of the EAUVA35352 series: UVA LEDs

UV, EAUVA35352 series LEDs at 500mA are listed below

Color	Order Code of EAUVA35352	Minimum Radiant Flux (mW)	Peak Wavelength (nm)	Forward Voltage (V)
Ultraviolet	EAUVA35352BC8	1000	360~370	3.0~4.0
	EAUVA35352EF8	1000	380~390	3.0~4.0
	EAUVA35352GH8	1000	390~400	3.0~4.0
	EAUVA35352IJ8	1000	400~410	3.0~4.0

## Product Binning

### Radiant Flux Bins

Bin Code	Minimum Radiant Flux (mW)	Maximum Radiant Flux (mW)
U2	1000	1100
U3	1100	1200
U4	1200	1300
U5	1300	1400
U6	1400	1500
U7	1500	1600

**Notes:**

1. Radiant flux measurement tolerance:  $\pm 10\%$ .
2. Forward voltage bins are defined at  $I_f=500\text{mA}$  operation.

### Peak Wavelength Bins

Group	Bin	Minimum Peak Wavelength (nm)	Maximum Peak Wavelength (nm)
U	36	360	370
	38	380	390
	39	390	400
	40	400	410

**Notes:**

1. Peak Wavelength measurement tolerance:  $\pm 1\text{nm}$ .
2. Forward voltage bins are defined at  $I_f=500\text{mA}$  operation.

### Forward Voltage Bins

Bin	Minimum Forward Voltage (V)	Maximum Forward Voltage (V)
3032	3.0	3.2
3234	3.2	3.4
3436	3.4	3.6
3638	3.6	3.8
3840	3.8	4.0

**Notes:**

1. Forward voltage measurement tolerance:  $\pm 2\%$ .
2. Forward voltage bins are defined at  $I_f=500\text{mA}$  operation.

## Mechanical Dimension

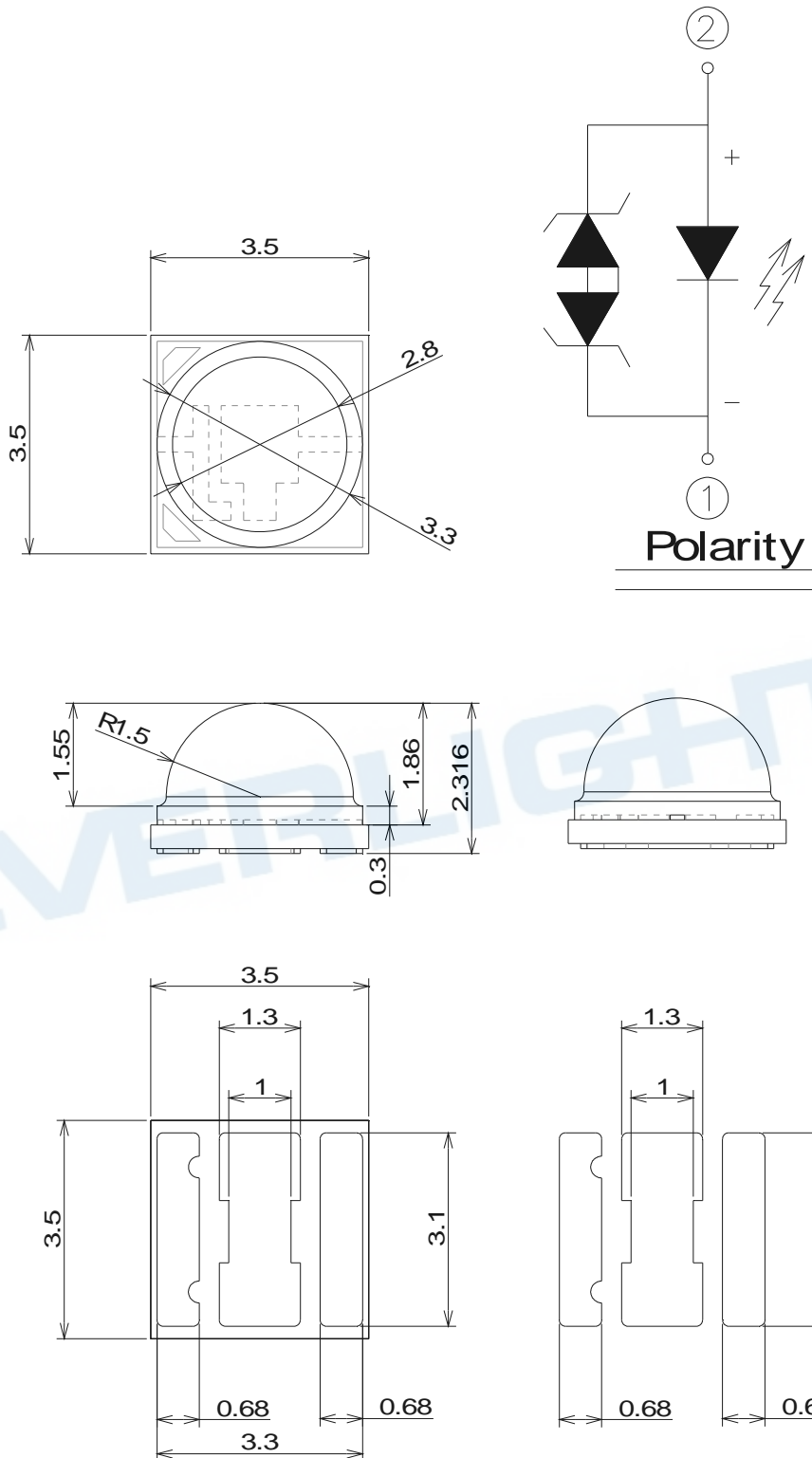

1. Dimensions are in millimeters.
2. Tolerances unless mentioned are  $\pm 0.1\text{mm}$

## Mechanical Dimension

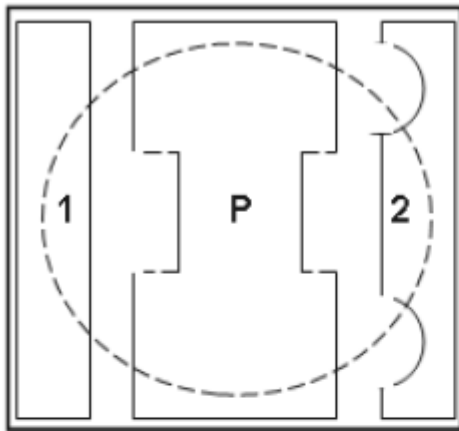

BOTTOM VIEW

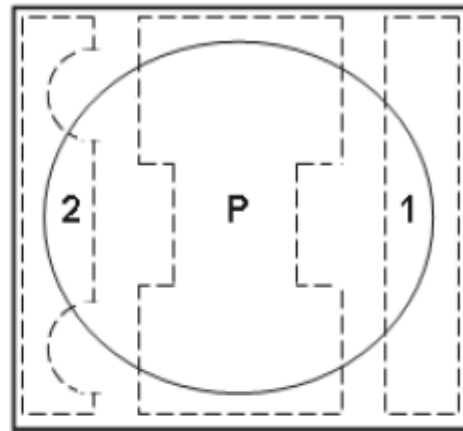

TOP VIEW

PAD	FUNCTION
1	ANODE
2	CATHODE
P	THERMAL PAD

## Reflow Soldering Characteristics

### For Reflow Process

- ELUA series are suitable for SMT processes.
- Curing of glue in oven must be according to standard operation flow processes.

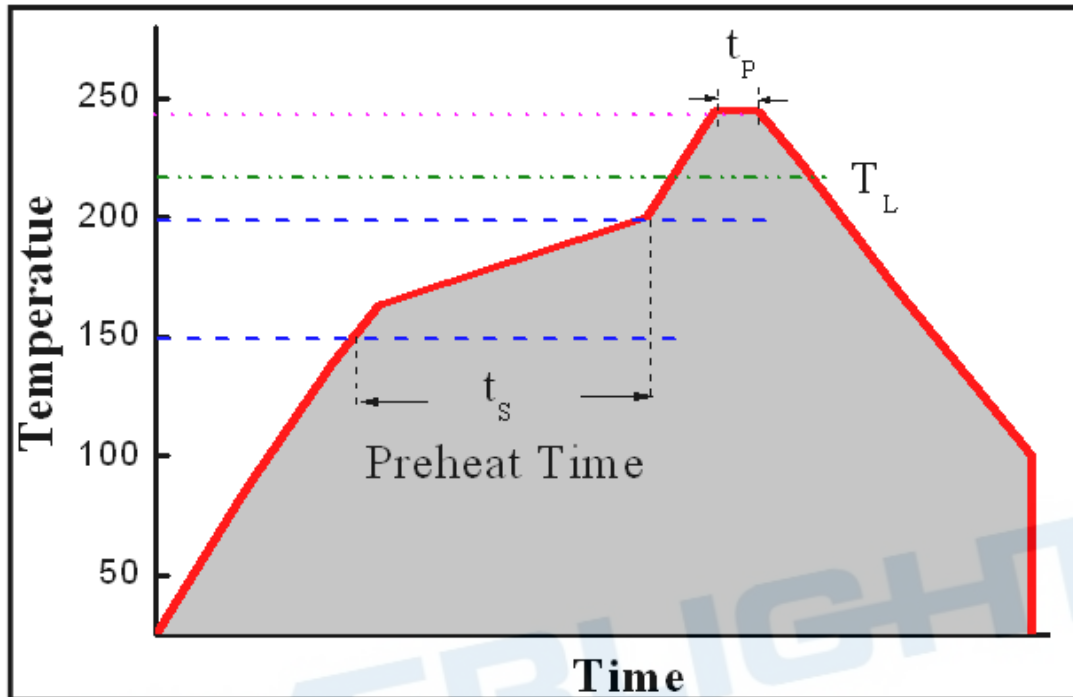

Profile Feature	Lead Free Assembly
Ramp-Up Rate	2-3 °C/S
Preheat Temperature	150-200 °C
Preheat Time ( $t_s$ )	60-120 S
Liquid Temperature ( $T_L$ )	217 °C
Time maintained above $T_L$	60-90 S
Peak Temperature ( $T_p$ )	240±5 °C
Peak Time ( $t_p$ )	Max 20 S
Ramp-Down Rate	3-5 °C/S

- Reflow soldering should not be done more than twice.
- In soldering process, stress on the LEDs during heating should be avoided.
- After soldering, do not bend the circuit board.

## Typical Characteristics Curves

Spectrum @ Thermal Pad Temperature = 25°C

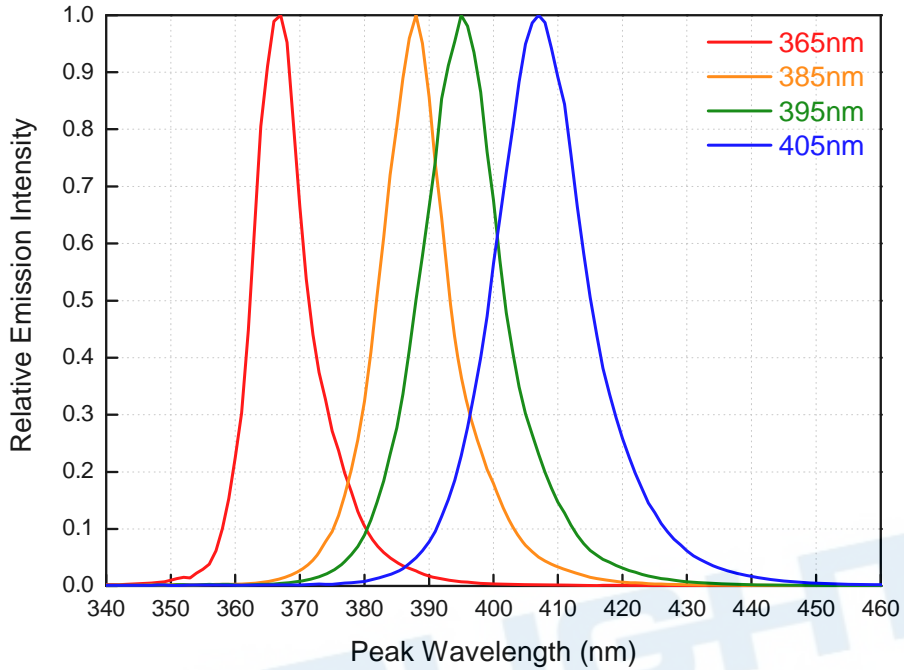

Relative Radiant Flux vs. Forward Current  
@ Thermal Pad Temperature = 25°C

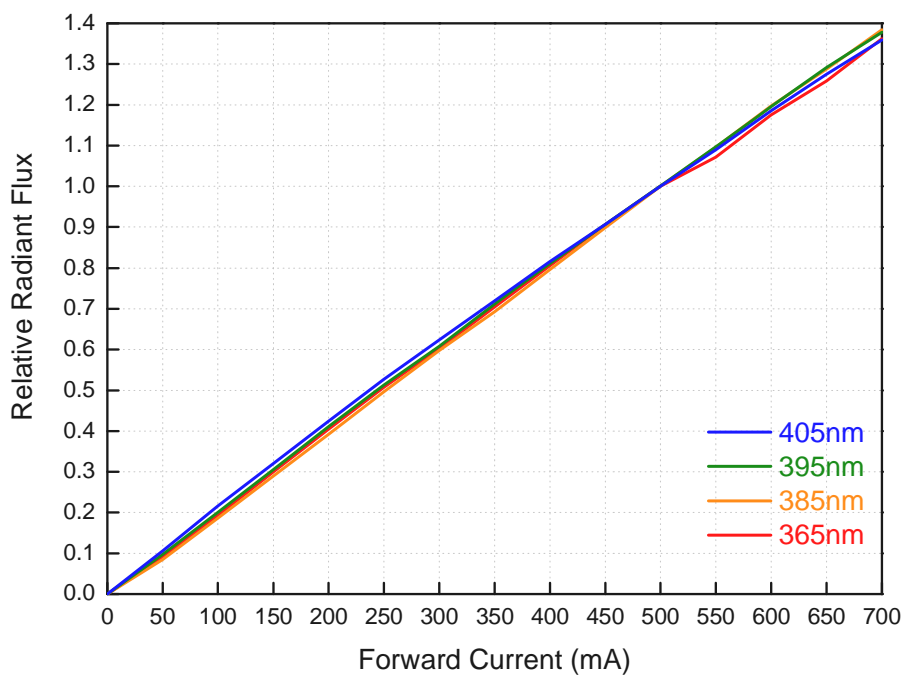



## Peak Wavelength vs. Forward Current @ Thermal Pad Temperature = 25°C

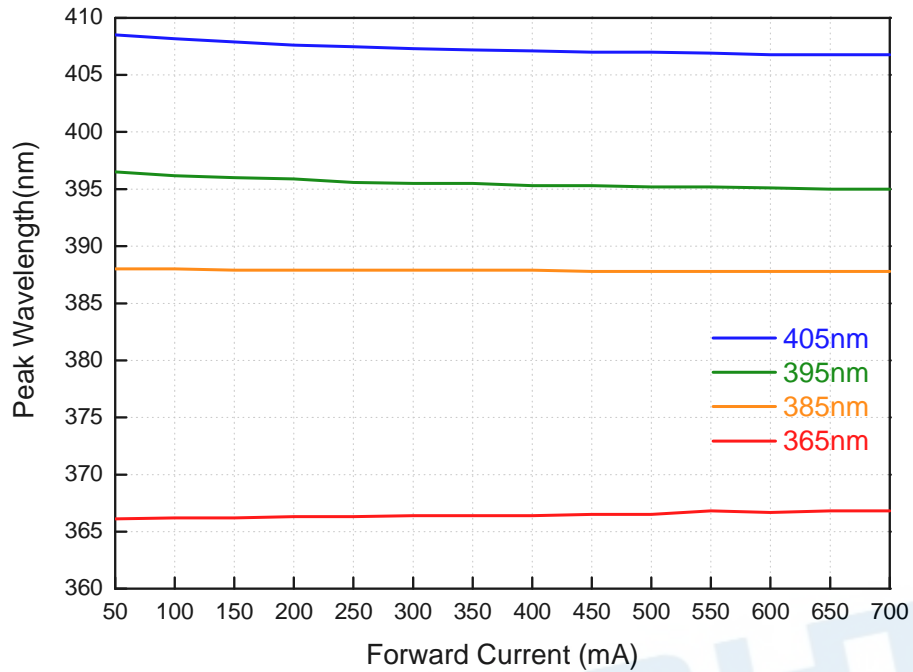

## Forward Voltage vs. Forward Current @ Thermal Pad Temperature = 25°C

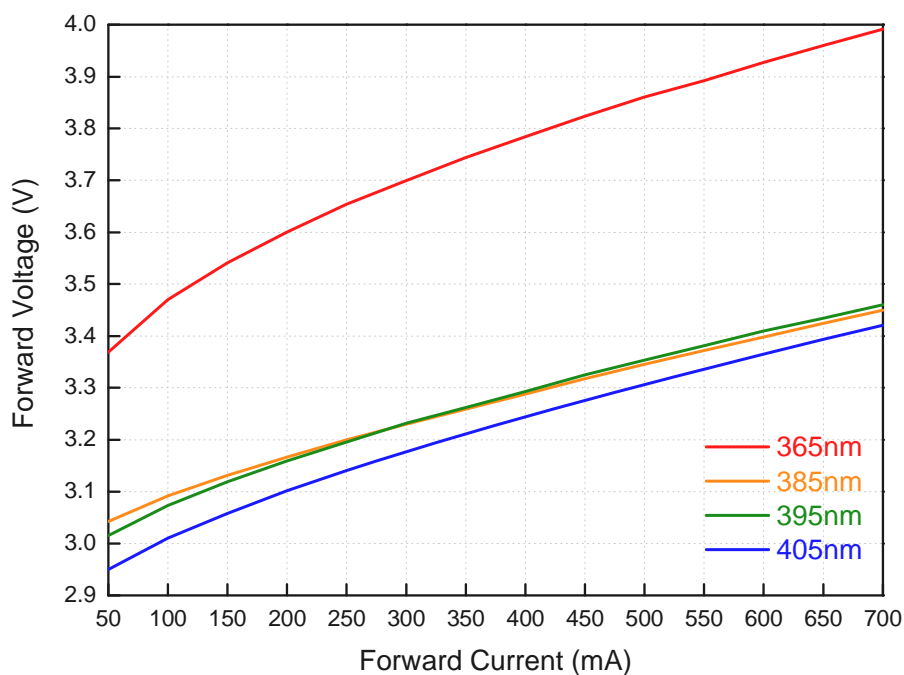

## Relative Radiant Flux vs. Ambient Temperature

@ Forward Current = 500mA

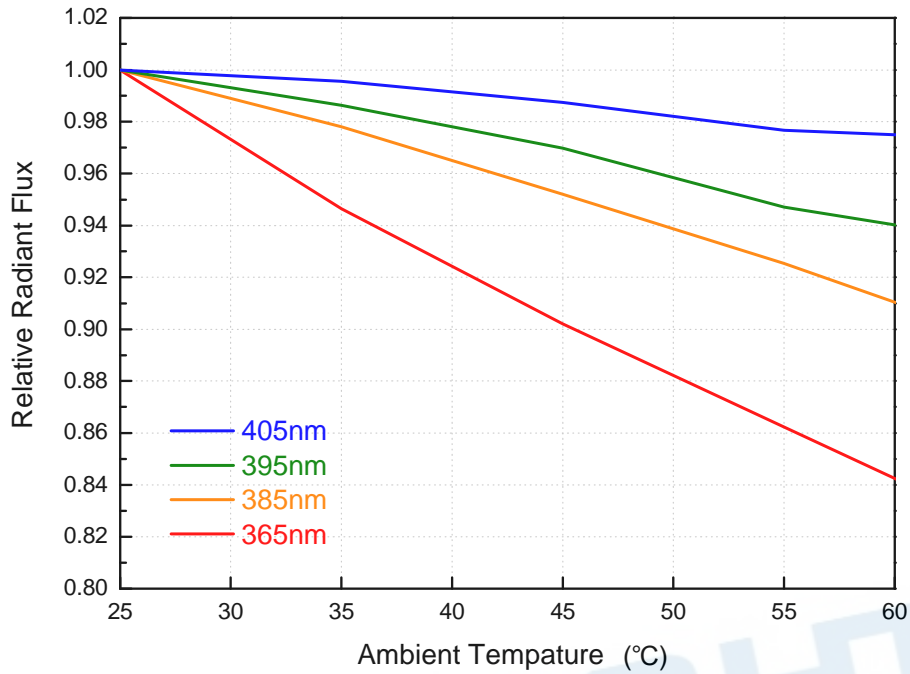

## Peak Wavelength vs. Ambient Temperature

@ Forward Current = 500mA

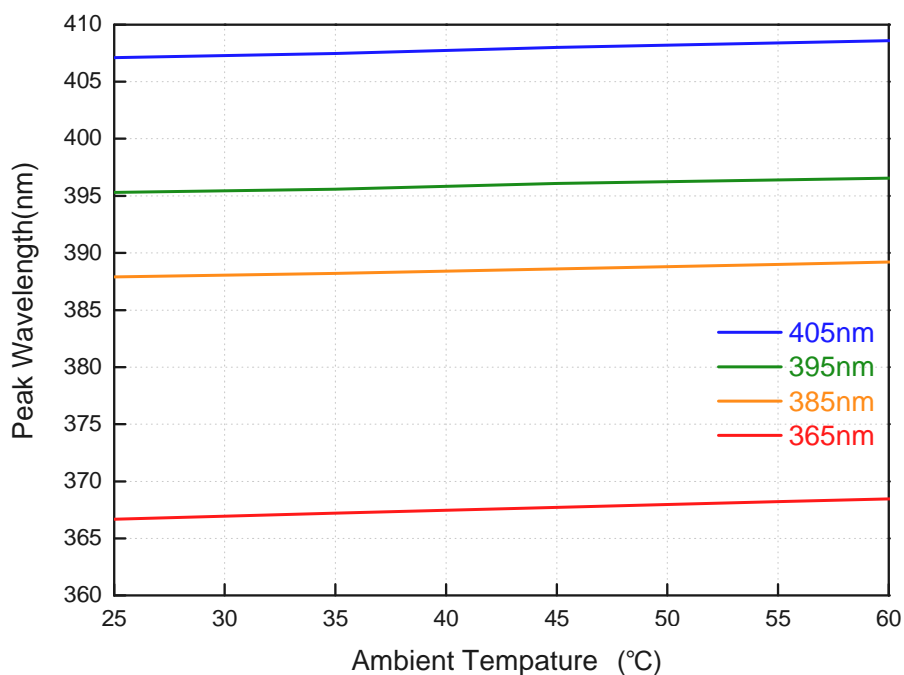

## Forward Voltage vs. Ambient Temperature @ Forward Current = 500mA

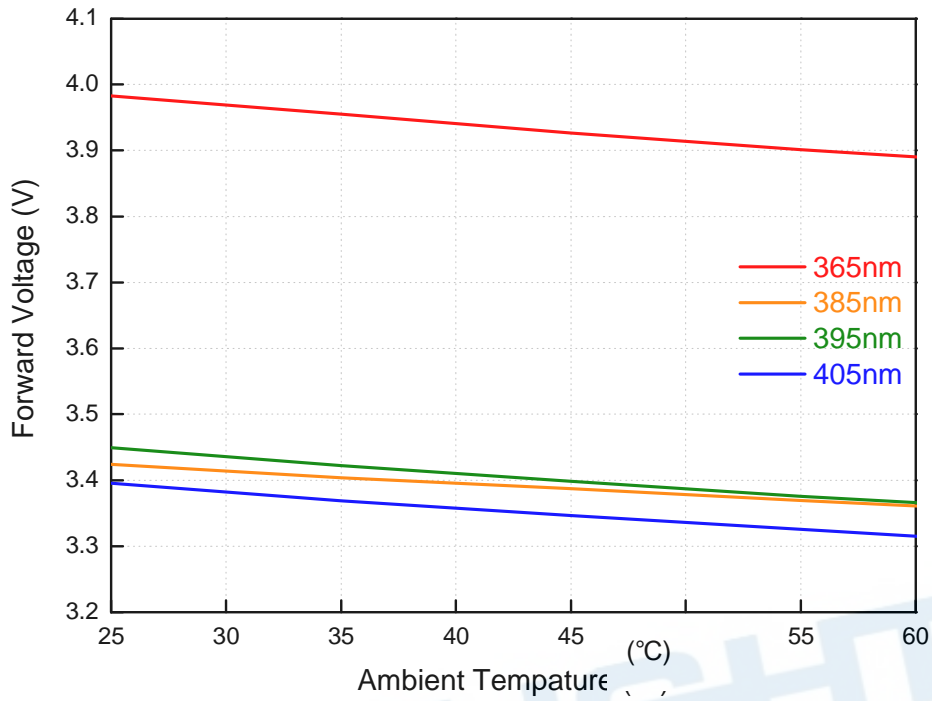

## Derating Curve

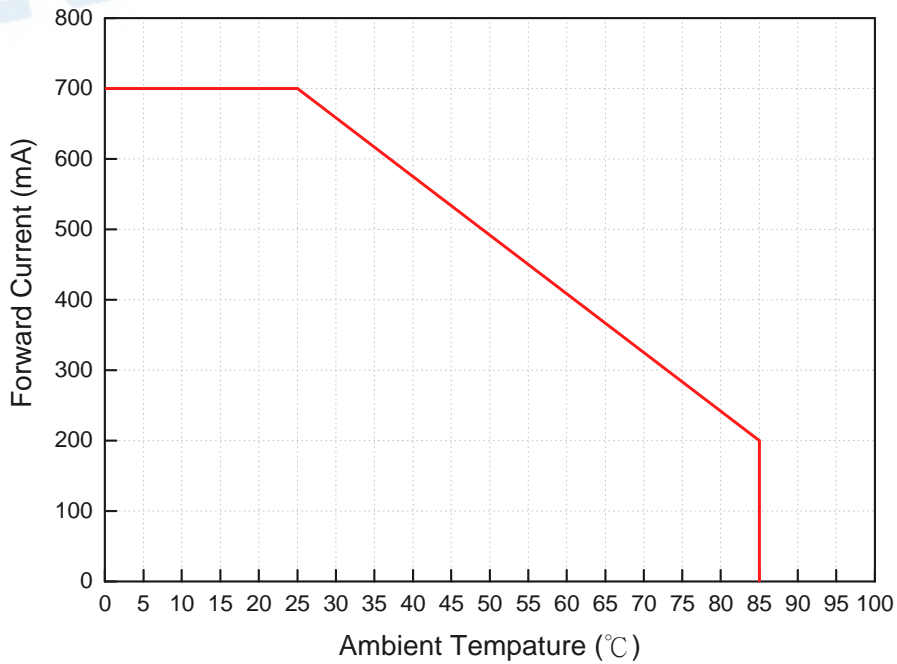

## Typical Radiation Patterns

### Typical Diagram Characteristics of Radiation for EAUVA35352

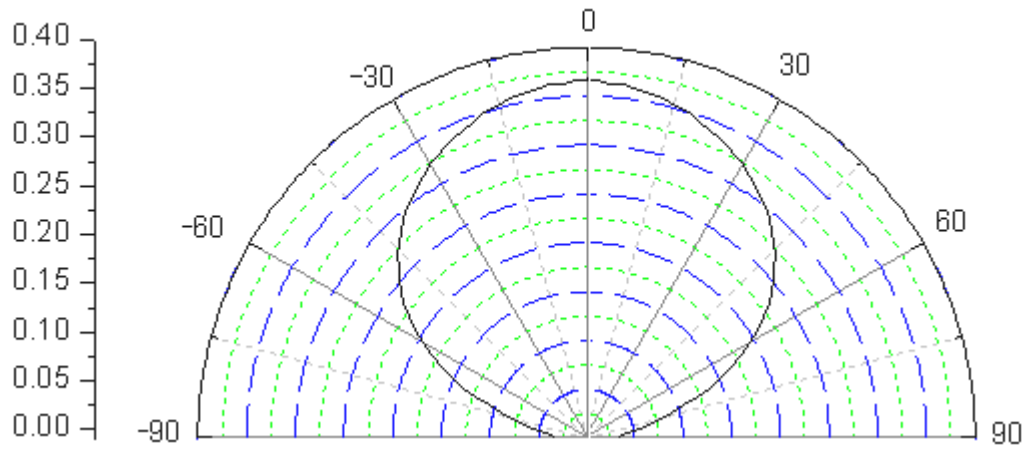

**Notes:**

1.  $2\theta_{1/2}$  is the off axis angle from lamp centerline where the luminous intensity is 1/2 of the peak value.
2. View angle tolerance is  $\pm 5^\circ$ .

EVERLIGHT

## Emitter Tape Packaging

Carrier Tape Dimensions as the following:

Reel: 400pcs

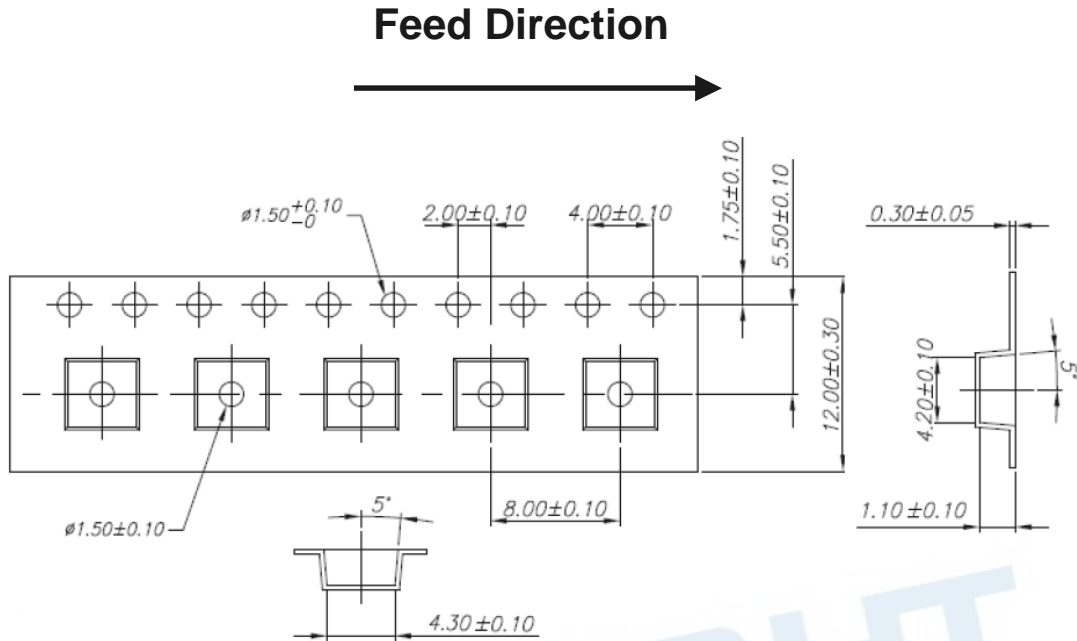

### Notes:

1. Tolerance unless mentioned is  $\pm 0.1$ mm;
2. Minimum packing amount is 100 pcs per reel

### Moisture Resistant Packaging

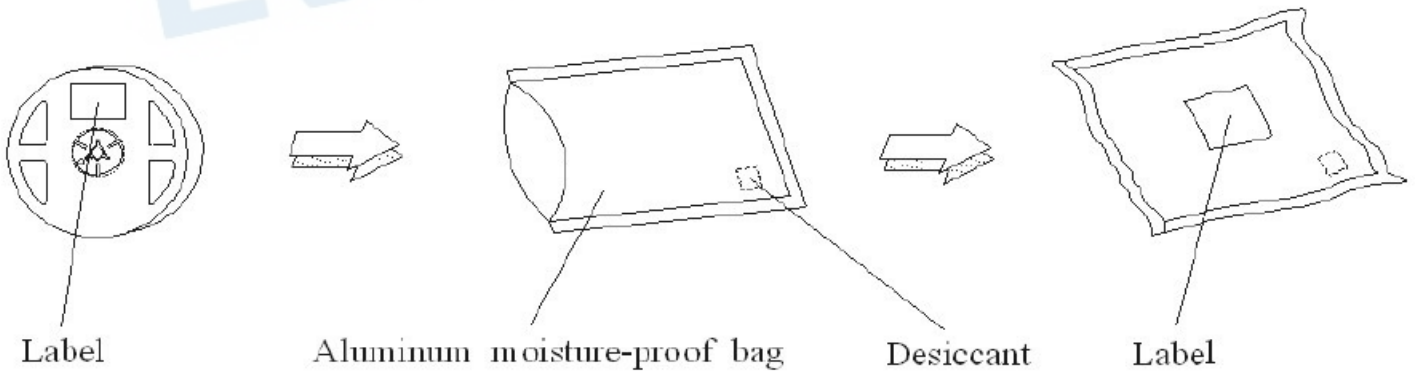

## Emitter Reel Dimensions

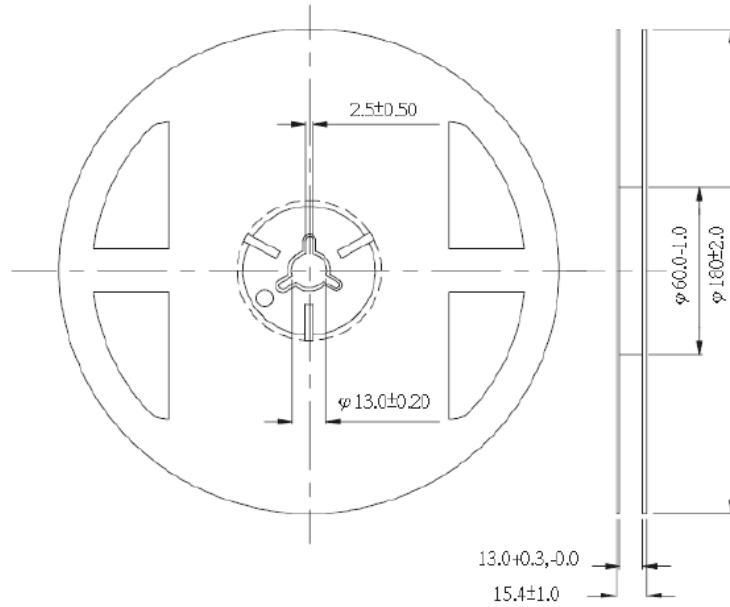

### Notes:

1. Dimensions are in millimeters.
2. Tolerances unless mentioned are  $\pm 0.1$ mm.

## Product Labeling

### Label Explanation

CPN: Customer Specification (when required)

P/N : Everlight Production Number

QTY: Packing Quantity

CAT: Luminous Flux (Brightness) Bin

HUE: Color Bin

REF: Forward Voltage Bin

LOT No: Lot Number

MADE IN TAIWAN: Production Place

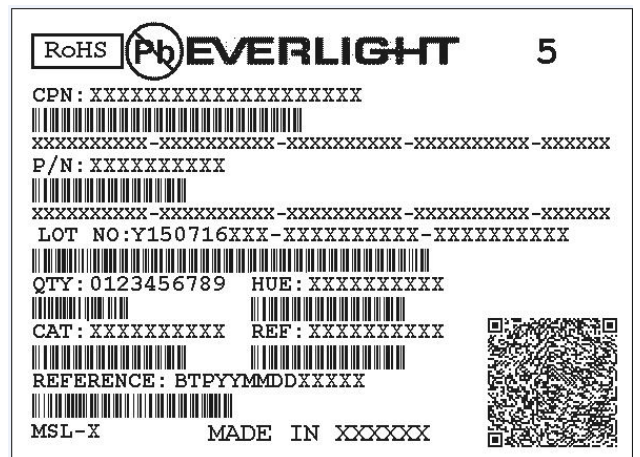

## Storage Conditions

- Before the package is opened. The LEDs should be stored at 30°C or less and 90%RH or less after being shipped from EVERLIGHT and the storage life limits are 12 months.
- After opening the package: The LED's floor life is 1 year under 30°C or less and 60% RH or less. If unused LEDs remain, it should be stored in moisture proof packages.
- If the moisture absorbent material (silica gel) has faded away or the LEDs have exceeded the storage time, baking treatment should be performed using the following conditions. Baking treatment: 60±5°C for 24 hours.

## DISCLAIMER

- EVERLIGHT reserves the right(s) on the adjustment of product material mix for the specification.
- The product meets EVERLIGHT published specification for a period of twelve (12) months from date of shipment.
- The graphs shown in this datasheet are representing typical data only and do not show guaranteed values.
- When using this product, please observe the absolute maximum ratings and the instructions for using outlined in these specification sheets. EVERLIGHT assumes no responsibility for any damage resulting from the use of the product which does not comply with the absolute maximum ratings and the instructions included in these specification sheets.
- These specification sheets include materials protected under copyright of EVERLIGHT. Reproduction in any form is prohibited without obtaining EVERLIGHT's prior consent.
- This product is not intended to be used for military, aircraft, automotive, medical, life sustaining or life saving applications or any other application which can result in human injury or death. Please contact authorized EVERLIGHT sales agent for special application request.