

EAITRAA1

Features

- Gap : 1.1 mm
- Slit : 0.3 mm
- Compact SMD Package
- Pb/Halogens free
- RoHS compliant

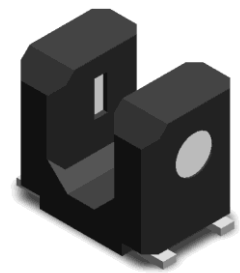

Description

- EAITRAA1 is an ultra small outline photo-interrupter, integrating both infrared emitter and silicon phototransistor detector with plastic molding housing.

Applications

- Printer
- Digital Camera
- Optical switch

Device No.	Chip Material
IR	AlGaAs
PT	Silicon

Absolute Maximum Ratings (Ta=25°C)

Parameter		Symbol	Ratings	Unit
Input	Power Dissipation at(or below) 25°C Free Air Temperature	Pd	75	mW
	Reverse Voltage	V _R	5	V
	Forward Current	I _F	50	mA
	Peak Forward Current (*1) Pulse width ≤100μs, Duty cycle=1%	I _{FP}	1	A
Output	Collector Power Dissipation	P _C	75	mW
	Collector Current	I _C	20	mA
	Collector-Emitter Voltage	B V _{CEO}	35	V
	Emitter-Collector Voltage	B V _{ECO}	6	V
Operating Temperature		T _{opr}	-40~+85	°C
Storage Temperature		T _{stg}	-40~+100	°C
Lead Soldering Temperature (*2) (1/16 inch form body for 5 seconds)		T _{sol}	260	°C

* 1. Pulse width $t_w = 100\mu s$, Period $T = 10ms$ * 2 $t \leq 5sec$

Electro-Optical Characteristics (Ta=25°C)

Parameter		Symbol	Min.	Typ.	Max.	Unit	Conditions
Input	Forward Voltage	V_F	---	1.2	1.4	V	$I_F=20mA$
	Reverse Current	I_R	---	---	10	μA	$V_R=6V$
	Peak Wavelength	λ_p	---	940	---	nm	$I_F=10mA$
Output	Dark C urrent	I_{CEO}	---	---	100	nA	$V_{CE}=20V$
	C-E Saturation Voltage	$V_{CE(sat)}$	---	---	0.4	V	$I_C=0.05mA$ $I_F=10mA$
Transfer Characteristics	Collect Current	$I_C(ON)$	150	---	1000	μA	$V_{CE}=2V$ $I_F=5mA$
	Rise time	t_r	---	9	---	μs	$V_{CE}=5V$ $I_C=1mA$ $R_L=1K\Omega$
	Fall time	t_f	---	8	---	μs	

Typical Electrical/Optical/Characteristics Curves for ITR

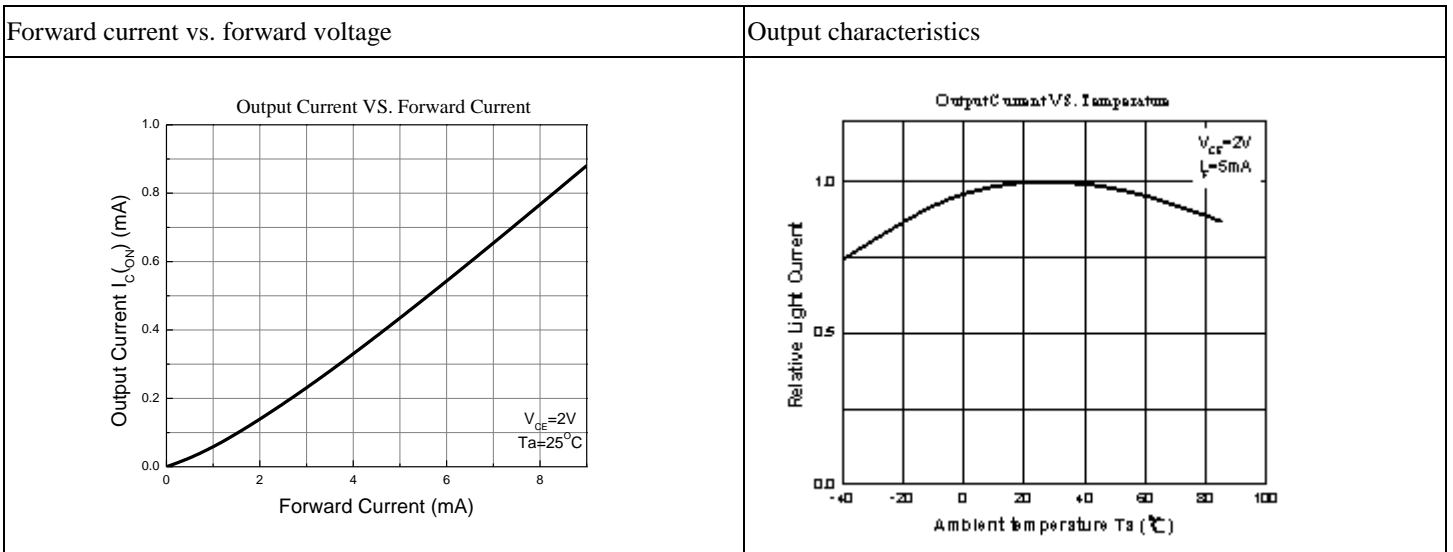
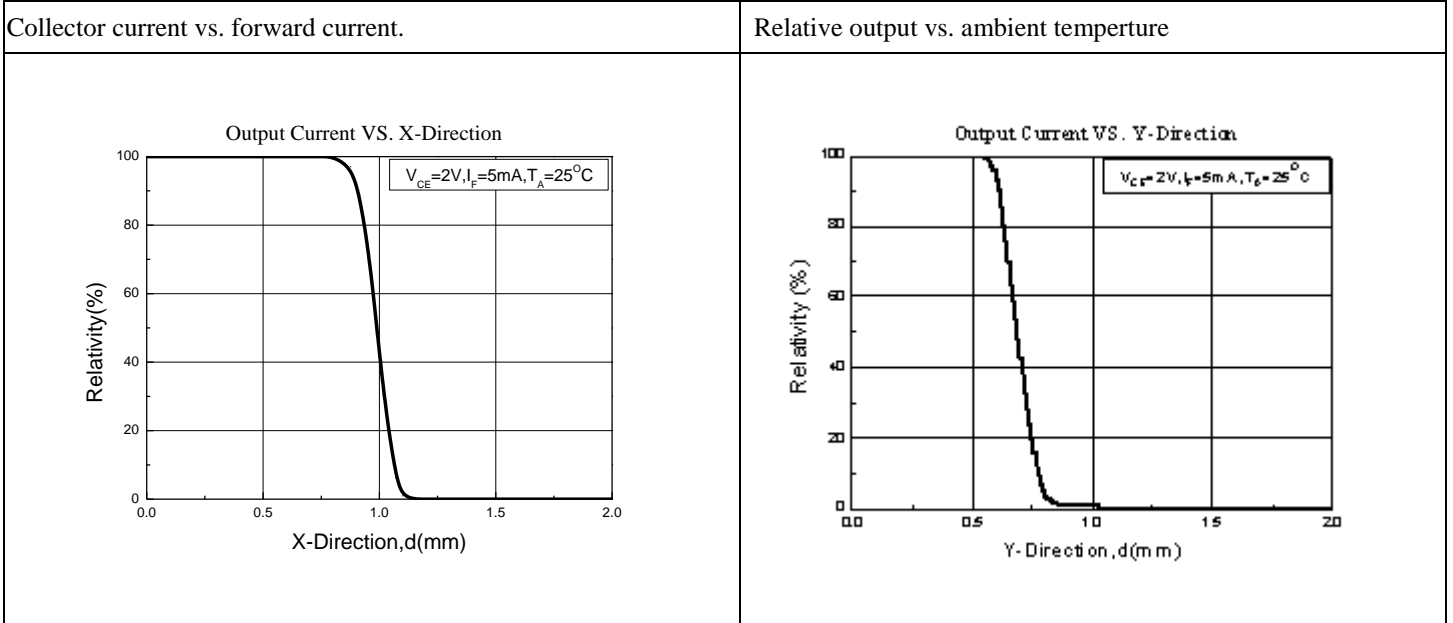

Spectral Distribution

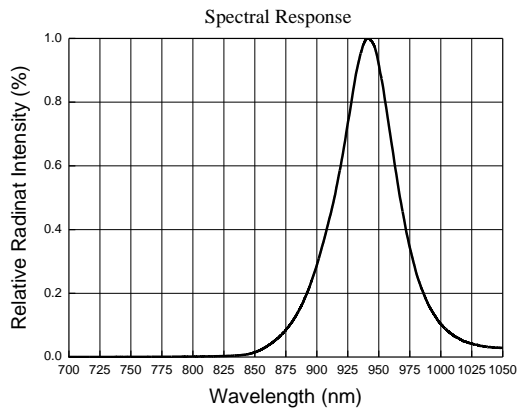

Spectral Distribution

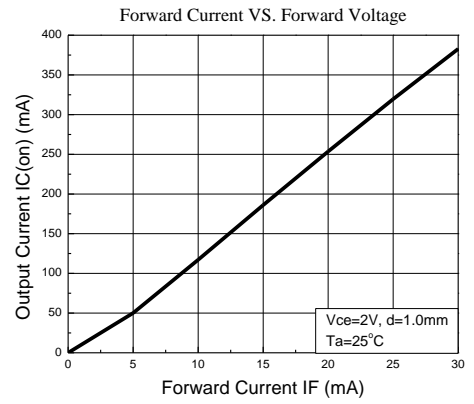

Spectral Distribution

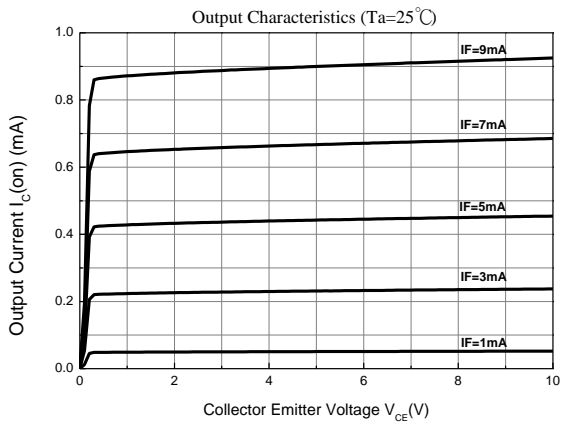

Spectral Distribution

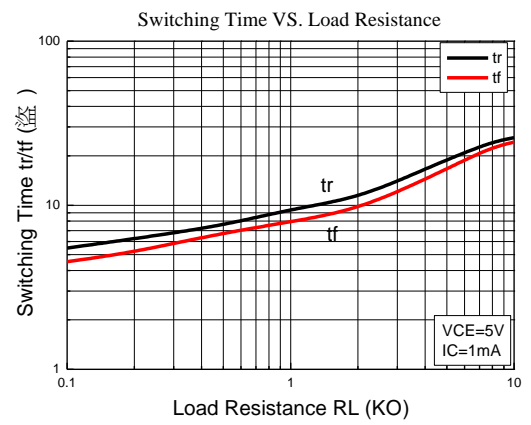

c

Package Dimension

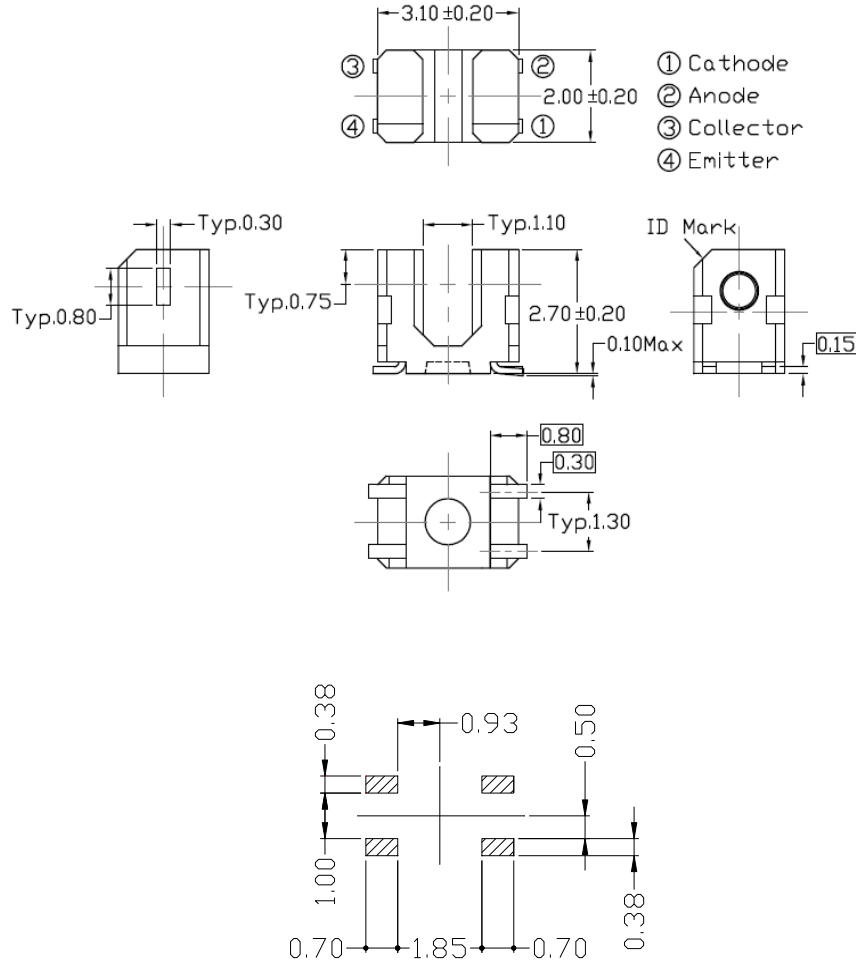

Soldering patterns

- Notes:** 1. All dimensions are in millimeters
2. Tolerances: ±0.2mm

Taping Dimension

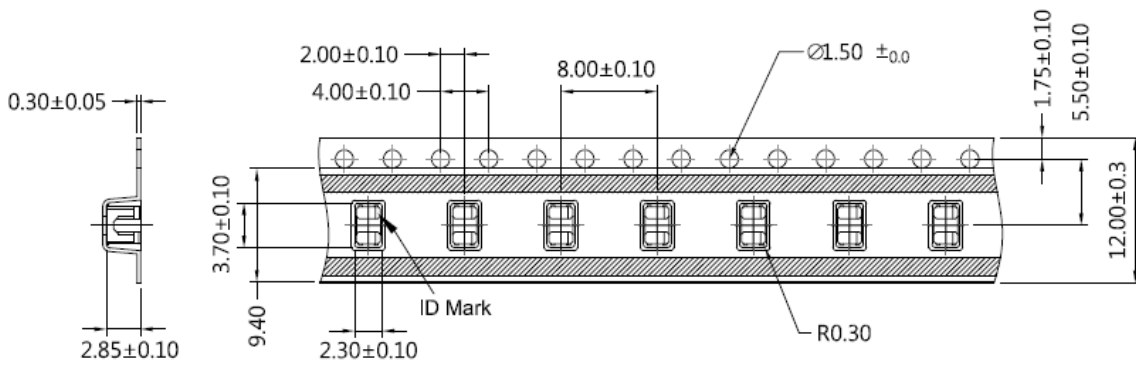

Reel Dimensions

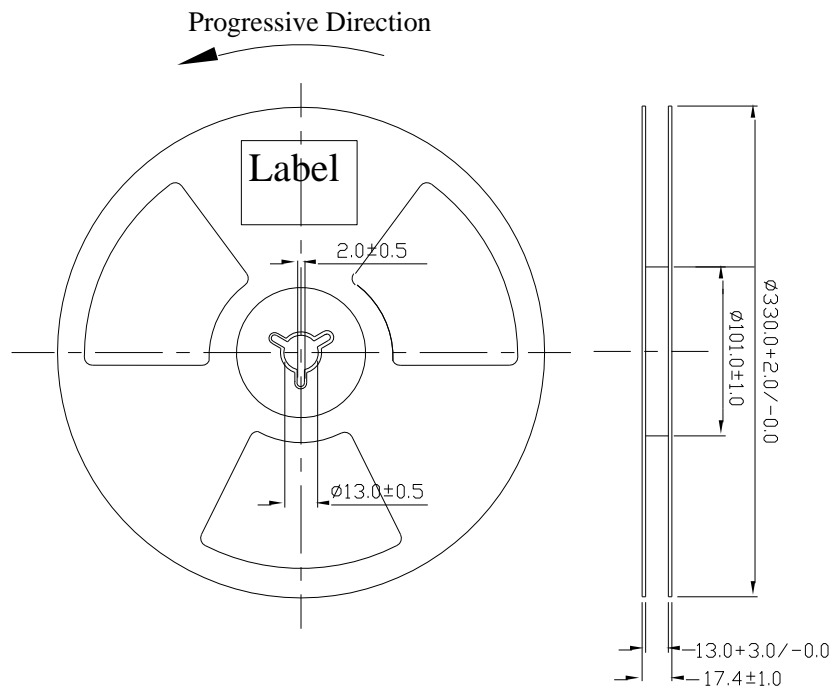

Packing Quantity Specification

- 3000pcs / 1 Reel
- 13 Reels (39Kpcs) / 1 Carton

Moisture Resistant Packaging

Aluminum Moistue-Proof Bag Dimension : 400mm*375mm

Vacuum Package

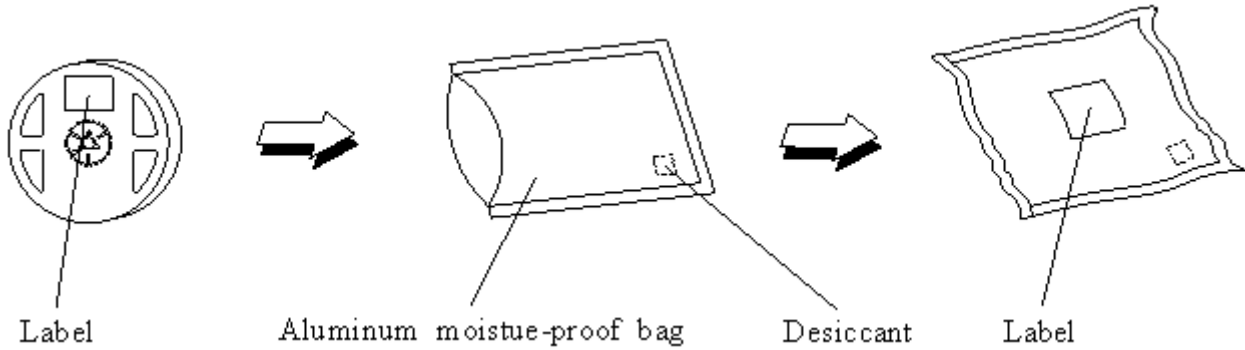

Outer Carton Dimension : 409mm(A)*245mm(B)*360mm(C)

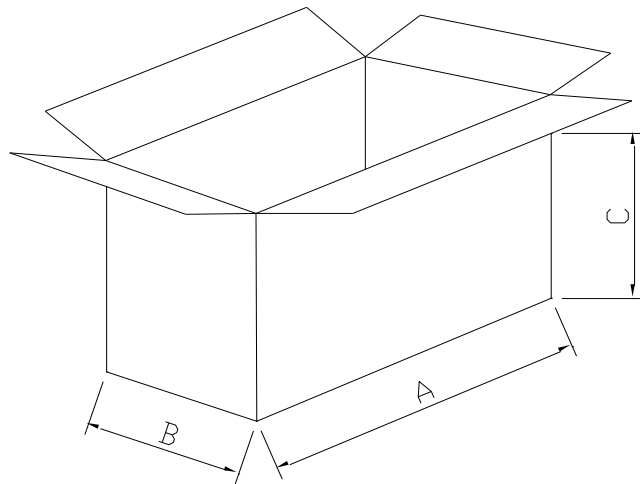

Label Form Specification

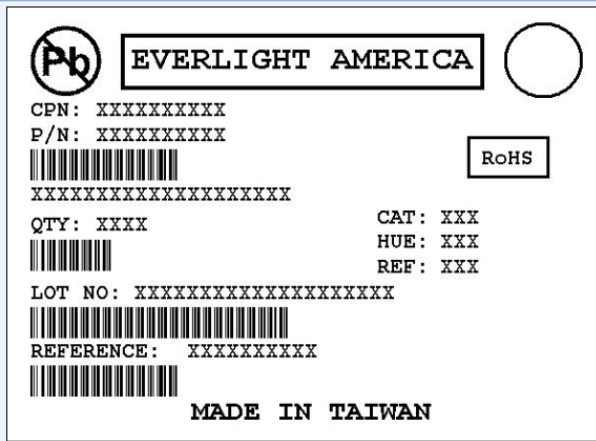

- CPN: Customer's Product Number
- P/N: Product Number
- QTY: Packing Quantity
- CAT: Luminous Intensity Rank
- HUE: Dom. Wavelength Rank
- REF: Forward Voltage Rank
- LOT No: Lot Number
- X: Month
- Reference: Identify Label Number

Notes

1. Above specification may be changed without notice. EVERLIGHT Americas will reserve authority on material change for above specification.
2. When using this product, please observe the absolute maximum ratings and the instructions for using outlined in these specification sheets. EVERLIGHT Americas assumes no responsibility for any damage resulting from use of the product which does not comply with the absolute maximum ratings and the instructions included in these specification sheets.
3. These specification sheets include materials protected under copyright of EVERLIGHT Americas corporation. Please don't reproduce or cause anyone to reproduce them without EVERLIGHT Americas consent.