

RECOMMENDED PANEL CUTOUT
 PANEL THICKNESS 1-10mm

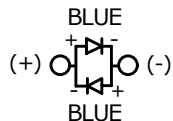

▲ SCHEMATIC ON-(ON)
 SPDT ILLUMINATED
 () DENOTES MOMENTARY FUNCTION

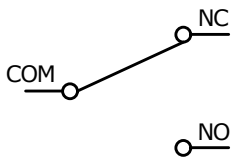
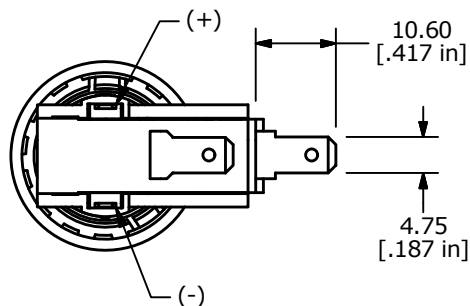
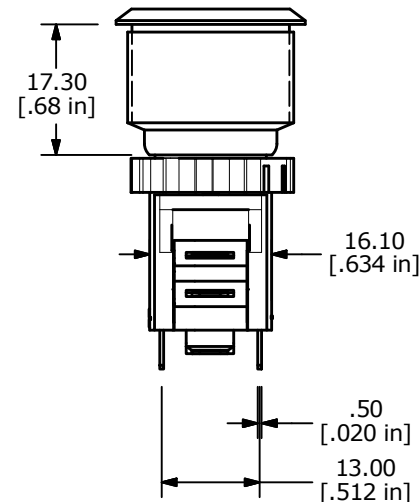
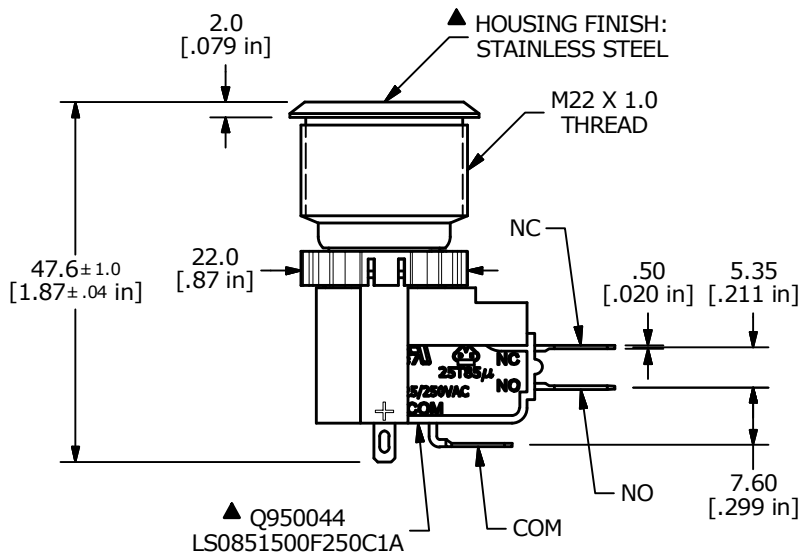
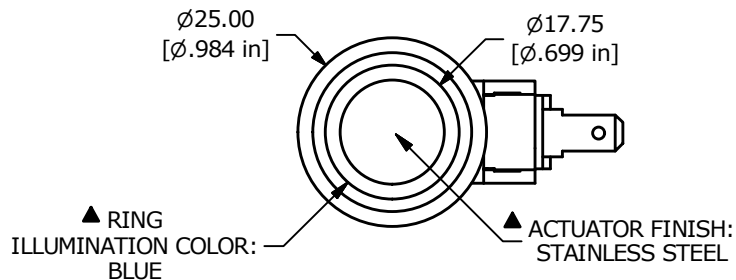

NOTES:

1. ALL DIMENSIONS IN MM [INCH]
2. GENERAL TOLERANCE: X.X = ± 0.4
 X.XX = ± 0.25
3. RATING: 15A @125/250VAC
- ▲ 4. OPERATING FORCE: 3.5 ± 1.5N
5. OPERATING TEMP: -25°C TO 85°C
6. ELECTRICAL LIFE: 10,000 CYCLES MIN.
7. MECHANICAL LIFE: 1,000,000 CYCLES TYP.
8. INSULATION RESISTANCE: 100 MEGA-OHMS MIN.
9. DIELECTRIC STRENGTH: 1500VAC 1 MINUTE (INITIAL VALUE)
10. CONTACT RESISTANCE: 100 MILLI-OHMS MAX.
11. ▲ DENOTES CRITICAL PARAMETER.
- ▲ 12. LAMP VOLTAGE: 3V
13. TRAVEL: 3.2mm
14. HEX NUT TORQUE: 1-3Nm
15. INGRESS PROTECTION: IP67
16. HARDWARE SUPPLIED: O-RING AND HEXNUT



TITLE SAV7F1BSS341				
SCALE 1:1	DATE 8/7/2019	DR MJR	DWG T957000	REV A

A	23992	NEW RELEASE	8/7/19	MJR
REV	PCR NO	DESCRIPTION	DATE	BY

THE INFORMATION CONTAINED IN THIS DOCUMENT IS PROPRIETARY TO E-SWITCH AND IS NOT TO BE COPIED OR TRANSFERRED