

SV8 SERIES ANTI-VANDAL SWITCH

ANTI-VANDAL SWITCHES
DETECTOR SWITCHES
DIP SWITCHES
KEYLOCK SWITCHES
NAVIGATION SWITCHES
PUSHBUTTON SWITCHES
ROCKER SWITCHES
ROTARY SWITCHES
SLIDE SWITCHES
SNAP ACTION SWITCHES
TACTILE SWITCHES
TOGGLE SWITCHES
CAP OPTIONS

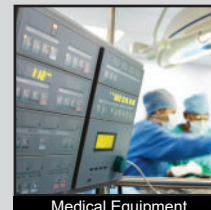

APPLICATIONS / MARKETS

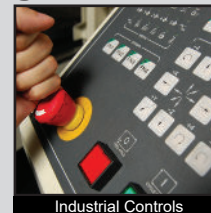

RoHS

SPECIFICATIONS

Electrical Rating: 2A, 36VDC
Mechanical Life: 1,000,000 Cycles
Electrical Life: 200,000 Cycles
Contact Resistance: 50mΩ Max. at 1A 12VDC
Insulation Resistance: 1,000MΩ Min. at 500VDC
Dielectric Strength: 2,000VAC for 1 minute
Operating/Storage Temperature: -20°C to 70°C
Travel: 1.80mm
Contact Material: Silver
Moisture Protection: IP67
Mechanical Impact Protection: IK10
Contact Arrangement: SPST
Actuation Force: 4.5 N
Panel Thickness: 1-6mm
Mounting Nut Torque: 1-3Nm

FEATURES & BENEFITS

- Short body design
- 25mm diameter panel cutout
- Multiple LED options
- Ring or Ring/Power Symbol illumination available
- IP67 rated
- SPST
- Soldered wire leads (500mm long) optional

PART NUMBER CONFIGURATOR

Series	Actuator Options	Terminal Options	Function Options	Body Finish Options	Actuator Finish Options	Lens Style Options	LED-Color Options	Illumination Voltage Options
SV8	F - Flat	2 - Solder W - Wire Leads 500mm long	3 - 1 Pole Off - (On)*	S - Stainless Steel	S - Stainless Steel	3 - Ring moveable with Actuator 6 - Ring / Power Symbol moveable with Actuator	0 - White 1 - Red 3 - Green 4 - Blue 5 - Yellow G - Red/Green H - Red/Blue	1 - Base Voltage [‡]

NOTES:

* () denotes function is momentary

[‡]Base voltage for LED colors Red and Yellow is 2.0V @ 20mA

[‡]Base voltage for LED colors Blue, Green and White is 3.1V @ 20mA

Specifications subject to change without notice 8.1.2022



E-SWITCH®

www.e-switch.com

800.867.2717

1

SV8 SERIES ANTI-VANDAL SWITCH

BODY DIMENSIONS

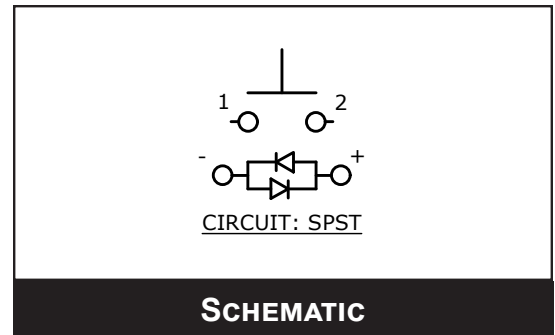
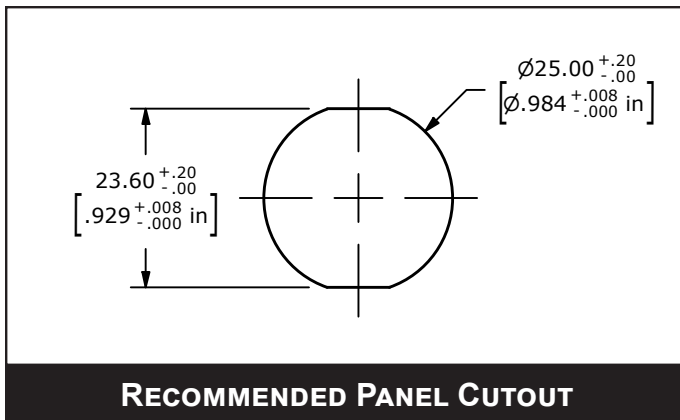
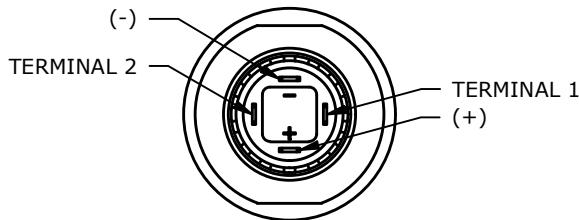
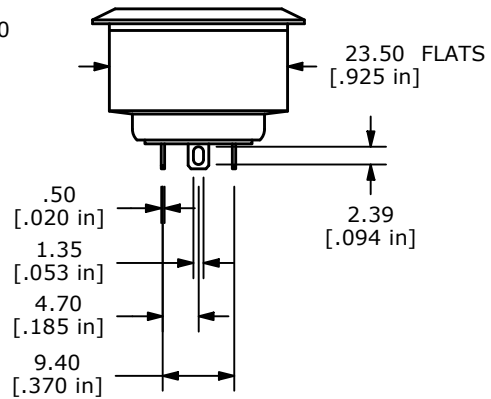
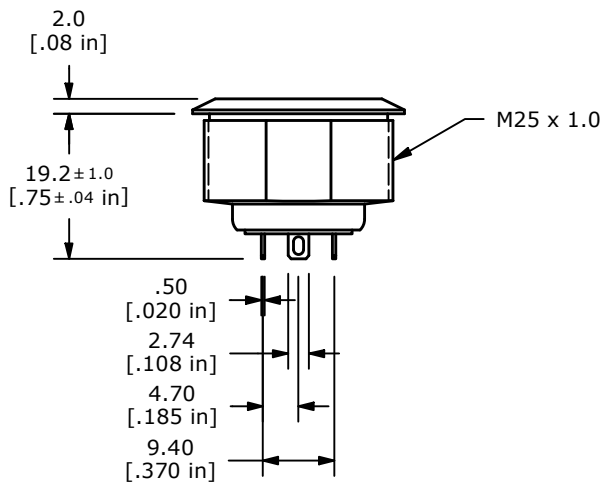
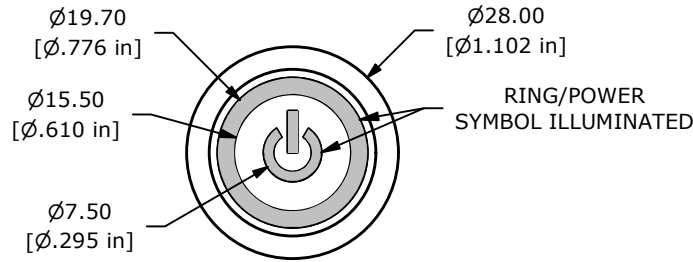

SV8 SERIES ANTI-VANDAL SWITCH

ACTUATOR OPTIONS

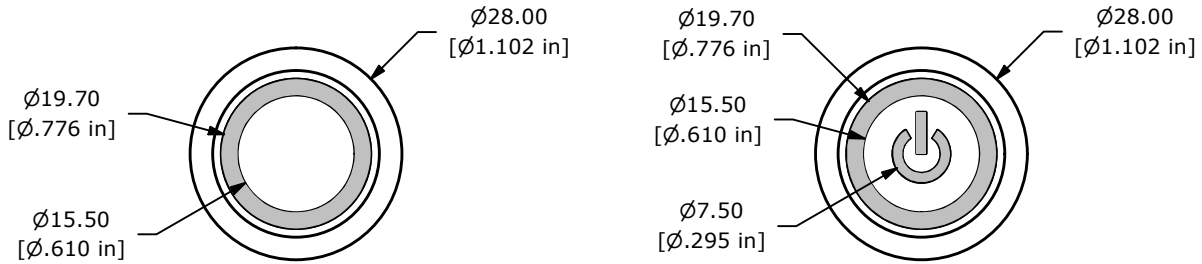

RING ILLUMINATED

POWER SYMBOL/RING ILLUMINATED

WIRE LEAD OPTION

SWITCH	WIRE	LENGTH
SW1-1	WIRE, 20AWG AWM UL3385, BLACK	500.0 [19.7 in]
SW1-2	WIRE, 20AWG AWM UL3385, BLACK	500.0 [19.7 in]
SW1- (-)	WIRE, 20AWG AWM UL3385, GREEN	500.0 [19.7 in]
SW1- (+)	WIRE, 20AWG AWM UL3385, RED	500.0 [19.7 in]

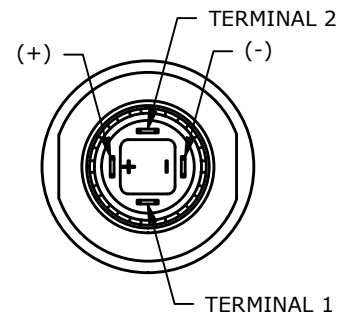
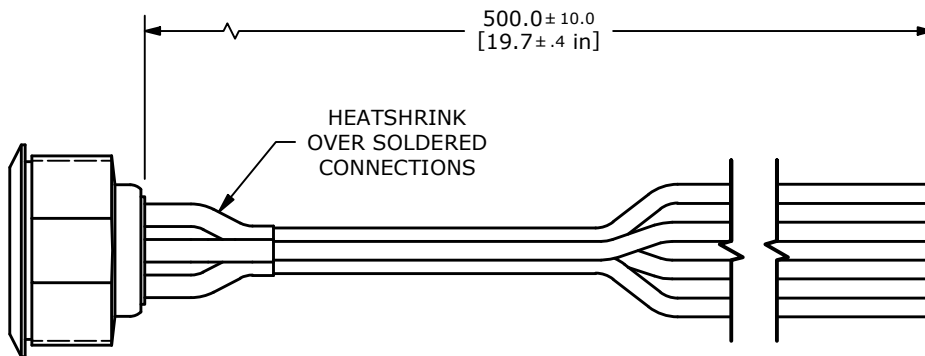

BOTTOM VIEW
SHOWN WITHOUT
WIRING

