

**BMR 453**  
DC/DC Converters, Input 36-75 V, Output 33 A/400 W

EN/LZT 146 395 R1B September 2008

© Ericsson AB

**Key Features**

- Industry standard Quarter-brick  
57.9 x 36.8 x 11.6 mm (2.28 x 1.45 x 0.46 in.)
- High efficiency, typ. 96 % at half load, 12 Vout
- +/- 2% output voltage tolerance band
- 1500 Vdc input to output isolation
- 1.1 million hours MTBF
- Optional baseplate
- ISO 9001/14001 certified supplier
- PMBus Revision 1.1 compliant

**Power Management**

- Configurable soft start/stop
- Precision delay and ramp-up
- Voltage sequencing and margining
- Voltage/current/temperature monitoring
- Configurable output voltage
- Power good
- Synchronization
- Voltage track



**Safety Approvals**



**Design for Environment**



Meets requirements in high-temperature lead-free soldering processes.

**Contents**

General Information	2
Safety Specification	3
Absolute Maximum Ratings	4
Functional Description	5
Product Program	Ordering No.
9 V, 33 A / 300 W - Electrical Specification	BMR 453..... 6
12 V, 33 A / 400 W - Electrical Specification	BMR 453..... 9
EMC Specification	12
Operating Information	13
Thermal considerations	15
Connections	16
PMBus communications	17
Mechanical Information	20
Soldering Information	22
Delivery Information	22
Product Qualification Specification	23

**BMR 453**  
DC/DC Converters, Input 36-75 V, Output 33 A/400 W

EN/LZT 146 395 R1B September 2008

© Ericsson AB

**General Information**

**Ordering Information**

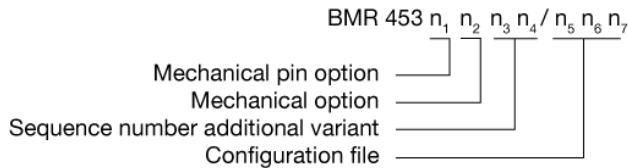

Number	Description
BMR453	Default
n <sub>1</sub>	0 = Standard pin length 5.33 mm 2 = Lead length 3.69 mm (cut) 3 = Lead length 4.57 mm (cut) 4 = Lead length 2.79 mm (cut) 5 = Lead length 2.79 mm stand off 6.7mm
n <sub>2</sub>	0 = Open frame 1 = Baseplate
n <sub>3</sub> n <sub>4</sub>	00 = With digital interface 01 = Without digital interface
n <sub>5</sub> n <sub>6</sub> n <sub>7</sub>	001 = 12V Default configuration variant 002 = 9V Default configuration variant

As an example an open frame, 3.69 mm pin length with digital interface with configuration variant 002 would be BMR4532000/002.

**Reliability**

The Mean Time Between Failure (MTBF) is calculated at full output power and an operating ambient temperature (T<sub>A</sub>) of +40°C, which is a typical condition in Information and Communication Technology (ICT) equipment. Different methods could be used to calculate the predicted MTBF and failure rate which may give different results. Ericsson Power Modules currently uses Telcordia SR332.

Predicted MTBF for the series is:

- 1.1 million hours according to Telcordia SR332, issue 1, Black box technique.

Telcordia SR332 is a commonly used standard method intended for reliability calculations in ICT equipment. The parts count procedure used in this method was originally modelled on the methods from MIL-HDBK-217F, Reliability Predictions of Electronic Equipment. It assumes that no reliability data is available on the actual units and devices for which the predictions are to be made, i.e. all predictions are based on generic reliability parameters.

**Compatibility with RoHS requirements**

The products are compatible with the relevant clauses and requirements of the RoHS directive 2002/95/EC and have a maximum concentration value of 0.1% by weight in homogeneous materials for lead, mercury, hexavalent chromium, PBB and PBDE and of 0.01% by weight in homogeneous materials for cadmium.

Exemptions in the RoHS directive utilized in Ericsson Power Modules products include:

- Lead in high melting temperature type solder (used to solder the die in semiconductor packages)
- Lead in glass of electronics components and in electronic ceramic parts (e.g. fill material in chip resistors)
- Lead as an alloying element in copper alloy containing up to 4% lead by weight (used in connection pins made of Brass)

**Quality Statement**

The products are designed and manufactured in an industrial environment where quality systems and methods like ISO 9000, 6σ (sigma), and SPC are intensively in use to boost the continuous improvements strategy. Infant mortality or early failures in the products are screened out and they are subjected to an ATE-based final test. Conservative design rules, design reviews and product qualifications, plus the high competence of an engaged work force, contribute to the high quality of our products.

**Warranty**

Warranty period and conditions are defined in Ericsson AB's General Terms and Conditions of Sale. Ericsson AB does not make any other warranties, expressed or implied including any warranty of merchantability, effects of product configurations made by customers or fitness for a particular purpose.

**© Ericsson AB 2008**

The information and specifications in this technical specification is believed to be correct at the time of publication. However, no liability is accepted for inaccuracies, printing errors or for any consequences thereof. Ericsson AB reserves the right to change the contents of this technical specification at any time without prior notice.

BMR 453 DC/DC Converters, Input 36-75 V, Output 33 A/400 W	EN/LZT 146 395 R1B September 2008
	© Ericsson AB

## Safety Specification

### General information

Ericsson Power Modules DC/DC converters and DC/DC regulators are designed in accordance with safety standards IEC/EN/UL60950, *Safety of Information Technology Equipment*.

IEC/EN/UL60950 contains requirements to prevent injury or damage due to the following hazards:

- Electrical shock
- Energy hazards
- Fire
- Mechanical and heat hazards
- Radiation hazards
- Chemical hazards

On-board DC-DC converters and DC/DC regulators are defined as component power supplies. As components they cannot fully comply with the provisions of any Safety requirements without "Conditions of Acceptability". Clearance between conductors and between conductive parts of the component power supply and conductors on the board in the final product must meet the applicable Safety requirements. Certain conditions of acceptability apply for component power supplies with limited stand-off (see Mechanical Information for further information). It is the responsibility of the installer to ensure that the final product housing these components complies with the requirements of all applicable Safety standards and Directives for the final product.

Component power supplies for general use should comply with the requirements in IEC60950, EN60950 and UL60950 "*Safety of information technology equipment*". There are other more product related standards, e.g. IEEE802.3af "Ethernet LAN/MAN Data terminal equipment power", and ETS300132-2 "Power supply interface at the input to telecommunications equipment; part 2: DC", but all of these standards are based on IEC/EN/UL60950 with regards to safety.

Ericsson Power Modules DC/DC converters and DC/DC regulators are UL60950 recognized and certified in accordance with EN60950.

The flammability rating for all construction parts of the products meets requirements for V-0 class material according to IEC 60695-11-10.

The products should be installed in the end-use equipment, in accordance with the requirements of the ultimate application. Normally the output of the DC/DC converter is considered as SELV (Safety Extra Low Voltage) and the input source must be isolated by minimum Double or Reinforced Insulation from the primary circuit (AC mains) in accordance with IEC/EN/UL60950.

### Isolated DC/DC converters

It is recommended that a slow blow fuse with a rating twice the maximum input current per selected product be used at the input of each DC/DC converter. If an input filter is used in the circuit the fuse should be placed in front of the input filter.

In the rare event of a component problem in the input filter or in the DC/DC converter that imposes a short circuit on the input source, this fuse will provide the following functions:

- Isolate the faulty DC/DC converter from the input power source so as not to affect the operation of other parts of the system.
- Protect the distribution wiring from excessive current and power loss thus preventing hazardous overheating.

The galvanic isolation is verified in an electric strength test. The test voltage ( $V_{iso}$ ) between input and output is 1500 Vdc or 2250 Vdc for 60 seconds (refer to Absolute maximum ratings).

Leakage current is less than 1  $\mu$ A at nominal input voltage.

### 24 V DC systems

The input voltage to the DC/DC converter is SELV (Safety Extra Low Voltage) and the output remains SELV under normal and abnormal operating conditions.

### 48 and 60 V DC systems

If the input voltage to the DC/DC converter is 75 Vdc or less, then the output remains SELV (Safety Extra Low Voltage) under normal and abnormal operating conditions.

Single fault testing in the input power supply circuit should be performed with the DC/DC converter connected to demonstrate that the input voltage does not exceed 75 Vdc.

If the input power source circuit is a DC power system, the source may be treated as a TNV2 circuit and testing has demonstrated compliance with SELV limits and isolation requirements equivalent to Basic Insulation in accordance with IEC/EN/UL60950.

### Non-isolated DC/DC regulators

The input voltage to the DC/DC regulator is SELV (Safety Extra Low Voltage) and the output remains SELV under normal and abnormal operating conditions.

**BMR 453**  
DC/DC Converters, Input 36-75 V, Output 33 A/400 W

EN/LZT 146 395 R1B September 2008

© Ericsson AB

**Absolute Maximum Ratings**

Characteristics		min	typ	max	Unit
T <sub>ref</sub>	Operating Temperature (see Thermal Consideration section)	-40		+125	°C
T <sub>s</sub>	Storage temperature	-55		+125	°C
V <sub>I</sub>	Input voltage	-0.5		+80	V
V <sub>iso</sub>	Isolation voltage (input to output test voltage), see note 1			1500	Vdc
V <sub>tr</sub>	Input voltage transient (Tp 100 ms)			100	V
V <sub>RC</sub>	Remote Control pin voltage	-0.3		18	V
V Logic	SALERT, CTRL, SYNC, SCL, SDA, SA(0,1)	-0.3		3.6	V

Stress in excess of Absolute Maximum Ratings may cause permanent damage. Absolute Maximum Ratings, sometimes referred to as no destruction limits, are normally tested with one parameter at a time exceeding the limits of Output data or Electrical Characteristics. If exposed to stress above these limits, function and performance may degrade in an unspecified manner.

Note 1: Isolation voltage (input/output to base-plate) max 750Vdc.

**Fundamental Circuit Diagram**

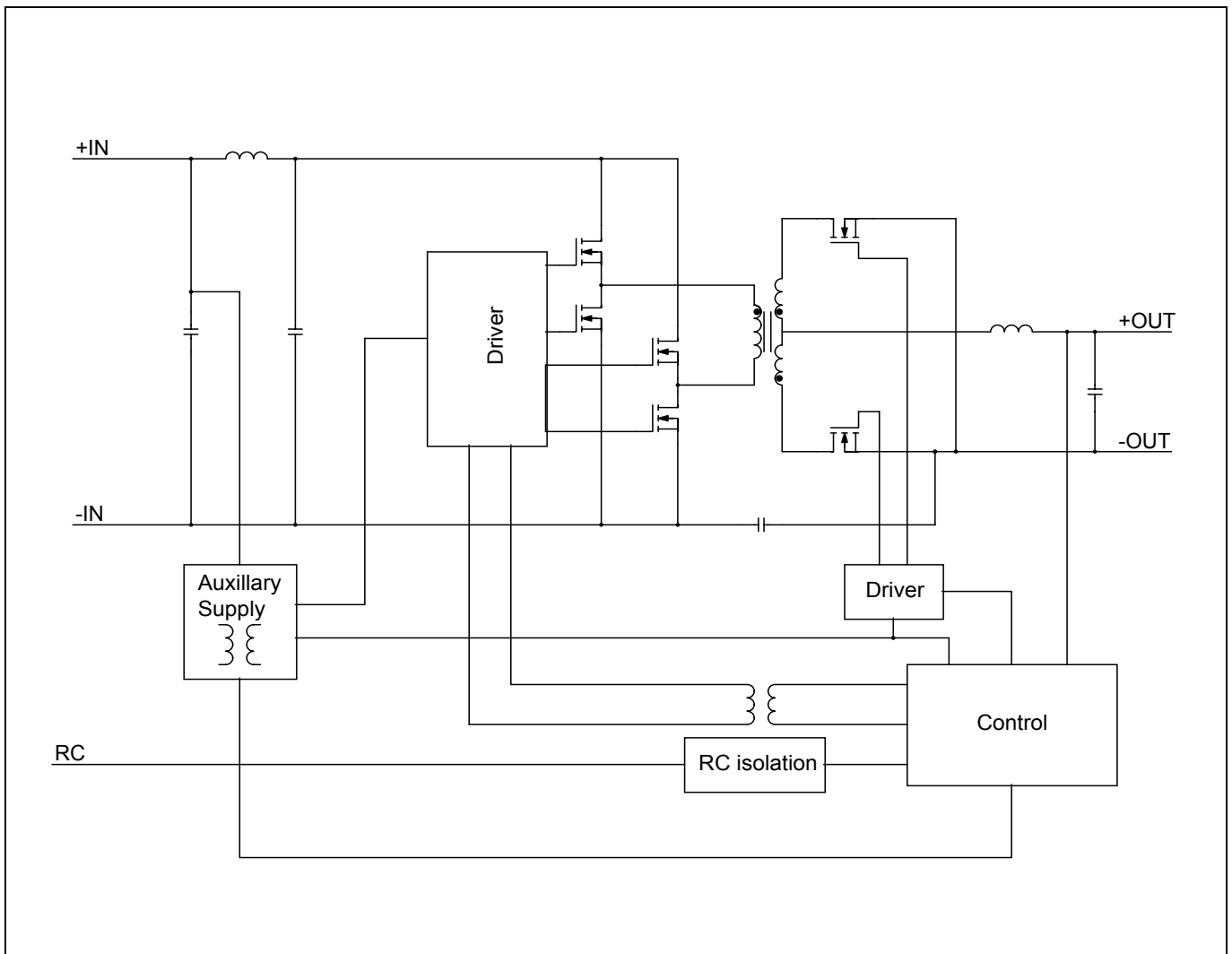

**BMR 453**  
 DC/DC Converters, Input 36-75 V, Output 33 A/400 W

EN/LZT 146 395 R1B September 2008

© Ericsson AB

## Functional Description

$T_{ref} = -40$  to  $+90^{\circ}\text{C}$ ,  $V_I = 36$  to  $75$  V, sense pins connected to output pins unless otherwise specified under Conditions.

Typical values given at:  $T_{ref} = +25^{\circ}\text{C}$ ,  $V_I = 53$  V, max  $I_O$ , unless otherwise specified under Conditions

Configuration File: 190 10-CDA 102 935/001 rev B

Characteristics		Conditions	min	typ	max	Unit
<b>PMBus monitoring</b>						
VIN_READ, 0x88h	Accuracy vs $V_I$		-3	+0.4	3	%
VOUT_READ, 0x8Bh	Accuracy vs $V_O$	$V_I = 53$ V	-1.0	-0.3	1.0	%
IOUT_READ, 0x8Ch	Accuracy vs $I_O$	$V_I = 53$ V, 50-100% of max $I_O$	-6	-1.0	6	%
IOUT_READ, 0x8Ch	Accuracy vs $I_O$	$V_I = 53$ V, 10% of max $I_O$	-20	-	20	%
<b>Fault Protection Characteristics</b>						
Input Under Voltage Lockout, UVLO	Factory default		-	33	-	V
	Setpoint accuracy		-3	-	3	%
	Hysteresis	Factory default	-	1.8	-	V
		Configurable via PMBus of threshold range, Note 1	0	-	-	V
	Delay		-	200	-	$\mu\text{s}$
(Output voltage) Over/Under Voltage Protection, OVP/UVP	VOUT_UV_FAULT_LIMIT	Factory default	-	0	-	V
		Configurable via PMBus, Note 1	0	-	16	V
	VOUT_OV_FAULT_LIMIT	Factory default	-	15.6	-	V
		Configurable via PMBus, Note 1	$V_{OUT}$	-	16	V
fault response time		-	200	-	$\mu\text{s}$	
Over Current Protection, OCP	Setpoint accuracy	$I_O$	-6	-	6	%
	IOUT_OC_FAULT_LIMIT	Factory default	-	39	-	A
		Configurable via PMBus, Note 1	0	-	100	A
fault response time		-	200	-	$\mu\text{s}$	
Over Temperature Protection, OTP	OTP_FAULT_LIMIT	Factory default	-	135	-	$^{\circ}\text{C}$
		Configurable via PMBus, Note 1	-50	-	135	
	OTP hysteresis	Factory default	-	10	-	
		Configurable via PMBus, Note 1	0	-	165	
fault response time		-	200	-	$\mu\text{s}$	
<b>Logic Input/Output Characteristics</b>						
Logic input low threshold ( $V_{IL}$ )		CTRL_CS, SA0, SA1, PG_SYNC, SCL, SDA,	-	-	0.8	V
Logic input high threshold ( $V_{IH}$ )		CTRL_CS, SA0, SA1, PG_SYNC, SCL, SDA,	2	-	3.45	V
Logic output low threshold ( $V_{OL}$ )		CTRL_CS, PG_SYNC, SALERT, SCL, SDA $I_{OL} = 5$ mA	-	-	0.4	V
Logic output high threshold ( $V_{OH}$ )		CTRL_CS, PG_SYNC, SALERT, SCL, SDA $I_{OH} = -5$ mA	2.8	-	-	V
Setup time, SMBus	Data change from high to low		250	-	-	ns
	Data change from low to high		250	-	-	ns
Hold time, SMBus	Data change from high to low		300	-	-	ns
	Data change from low to high		300	-	-	ns

<b>BMR 453</b> DC/DC Converters, Input 36-75 V, Output 33 A/400 W	EN/LZT 146 395 R1B September 2008
	© Ericsson AB

**9.0V, 33A / 300W Electrical Specification**
**BMR 453 xxxx/002**
 $T_{ref} = -40$  to  $+90^{\circ}\text{C}$ ,  $V_I = 36$  to  $75$  V, sense pins connected to output pins  $V_O$  unless otherwise specified under Conditions.

 Typical values given at:  $T_{ref} = +25^{\circ}\text{C}$ ,  $V_I = 53$  V, max  $I_O$ , unless otherwise specified under Conditions.

Configuration File: 190 10-CDA 102 935/002 rev B

Characteristics		Conditions	min	typ	max	Unit
$V_I$	Input voltage range		36		75	V
$V_{loff}$	Turn-off input voltage	Decreasing input voltage	32	33	34	V
$V_{lon}$	Turn-on input voltage	Increasing input voltage	34	35	36	V
$C_I$	Internal input capacitance			18		$\mu\text{F}$
$P_O$	Output power		0		297	W
$\eta$	Efficiency	50 % of max $I_O$		96		%
		max $I_O$		95		
		50 % of max $I_O$ , $V_I = 48$ V		96		
		max $I_O$ , $V_I = 48$ V		95		
$P_d$	Power Dissipation	max $I_O$		16.0	24.7	W
$P_{li}$	Input idling power	$I_O = 0$ A, $V_I = 53$ V		2.1		W
$P_{RC}$	Input standby power	$V_I = 53$ V (turned off with RC)		190		mW
$f_s$	Switching frequency	0-100 % of max $I_O$		140		kHz

$V_{Oi}$	Output voltage initial setting and accuracy	$T_{ref} = +25^{\circ}\text{C}$ , $V_I = 53$ V, $I_O = 33$ A	8.90	9.0	9.10	V
$V_O$	Output adjust range	See operating information	8.1		13.5	V
	Output voltage tolerance band	10-100% of max $I_O$	8.82		9.18	V
	Idling voltage	$I_O = 0$ A	8.82		9.18	V
	Line regulation	max $I_O$		20	50	mV
	Load regulation	$V_I = 53$ V, 1-100% of max $I_O$		7	30	mV
$V_{tr}$	Load transient voltage deviation	$V_I = 53$ V, Load step 25-75-25 % of max $I_O$ , $di/dt = 1$ A/ $\mu\text{s}$ , $C_O = 3.3\text{mF}$		$\pm 0.3$		V
$t_{tr}$	Load transient recovery time	see Note 1		250		$\mu\text{s}$
$t_r$	Ramp-up time (from 10-90 % of $V_O$ )	10-100% of max $I_O$		8	10	ms
$t_s$	Start-up time (from $V_I$ connection to 90% of $V_O$ )	$T_{ref} = 25^{\circ}\text{C}$ , $V_I = 53$ V		140	150	ms
$t_f$	$V_{in}$ shutdown fall time (from $V_I$ off to 10% of $V_O$ )	max $I_O$		0.4		ms
		$I_O = 0$ A		7		s
$t_{RC}$	RC start-up time	max $I_O$		53		ms
	RC shutdown fall time (from RC off to 10% of $V_O$ )	max $I_O$		3.2		ms
		$I_O = 0$ A		7		s
$I_O$	Output current		0		33	A
$I_{lim}$	Current limit threshold	$V_O = 8.1\text{V}$ , $T_{ref} < \text{max } T_{ref}$	34	38	43	A
$I_{sc}$	Short circuit current	$T_{ref} = 25^{\circ}\text{C}$ , $V_O < 0.2\text{V}$ , see Note 2		19		A
$V_{Oac}$	Output ripple & noise	See ripple & noise section, max $I_O$ , $V_{Oi}$		80	170	mVp-p
OVP	Over voltage protection	$T_{ref} = +25^{\circ}\text{C}$ , $V_I = 53$ V, 10-100% of max $I_O$		15.6		V

Note 1: Output filter according to Ripple &amp; Noise section.

Note 2: RMS current in hiccup mode.

**BMR 453**  
 DC/DC Converters, Input 36-75 V, Output 33 A/400 W

EN/LZT 146 395 R1B September 2008  
 © Ericsson AB

**9.0V, 33A / 300W Electrical Specification**

**BMR 453 xxxx/002**

**Efficiency**

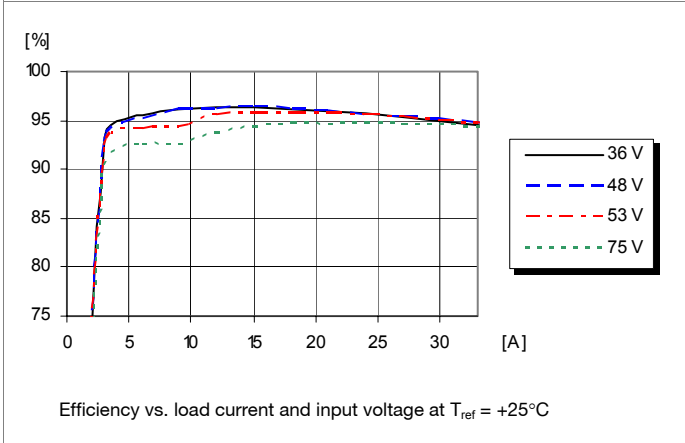

**Power Dissipation**

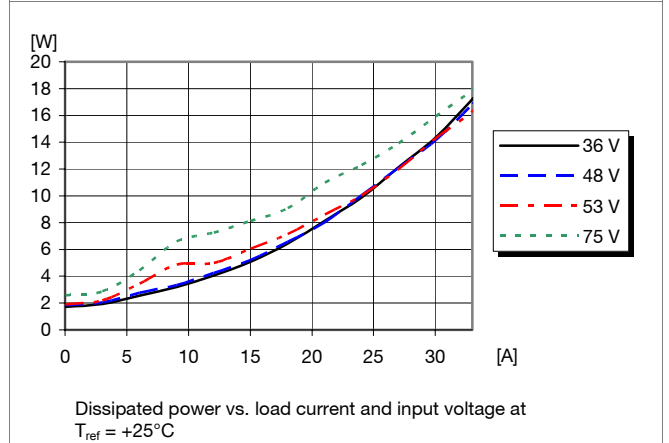

**Output Current Derating, open frame**

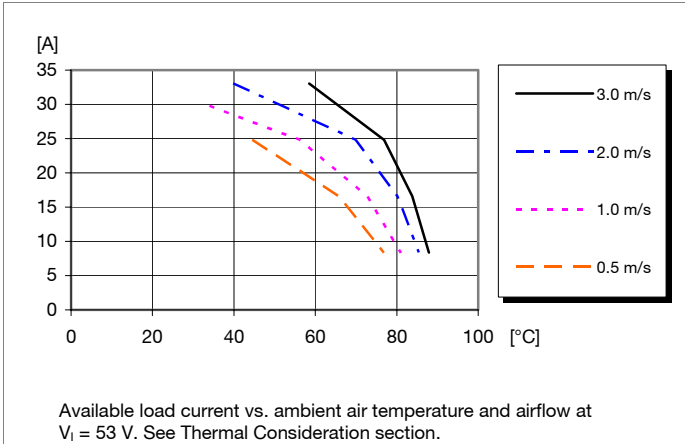

**Output Current Derating, base plate option**

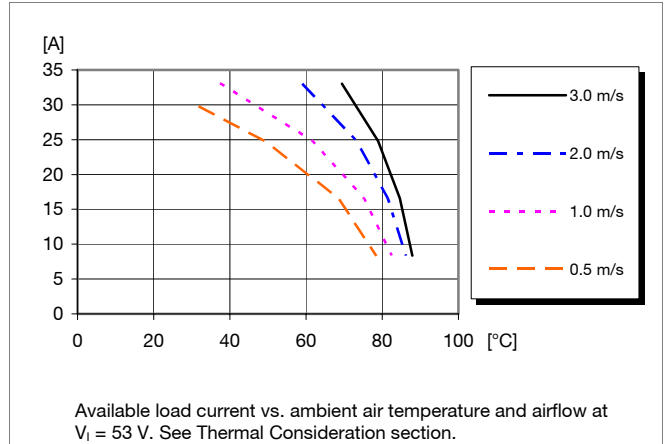

**Thermal Resistance, base plate option**

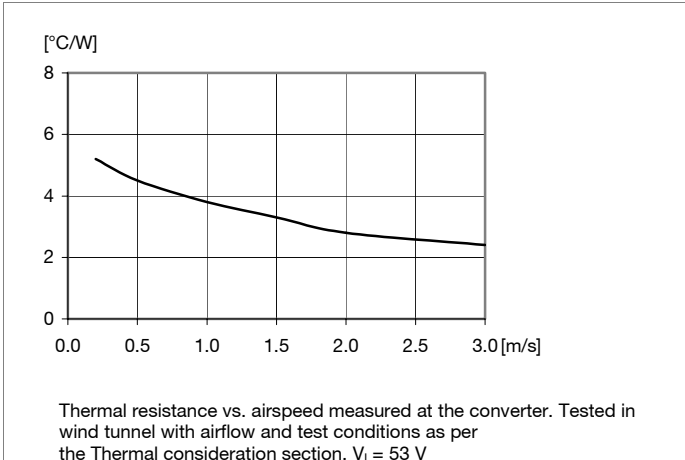

**BMR 453**  
 DC/DC Converters, Input 36-75 V, Output 33 A/400 W

EN/LZT 146 395 R1B September 2008

© Ericsson AB

**9.0V, 33A / 300W Electrical Specification**

**BMR 453 xxxx/002**

**Output Characteristics**

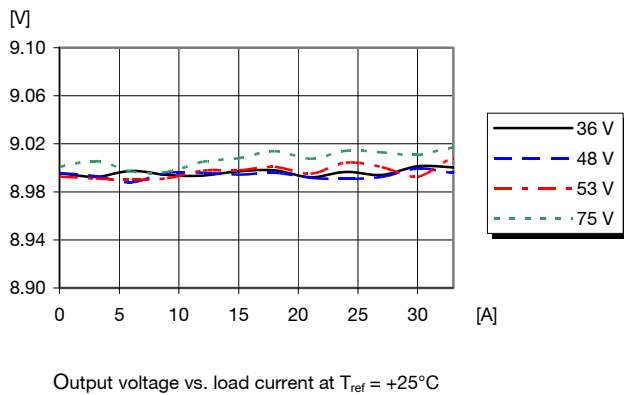

**Current Limit Characteristics**

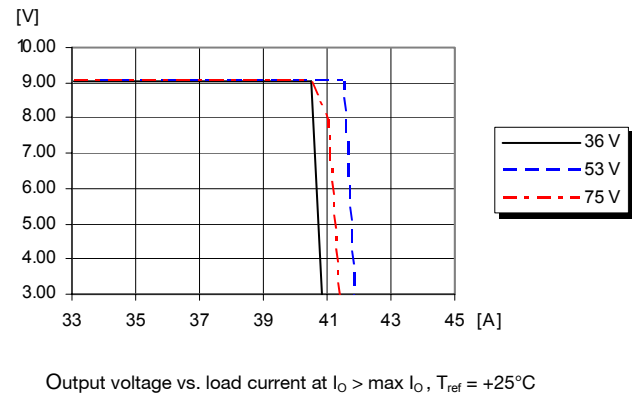

**Start-up Start-up**

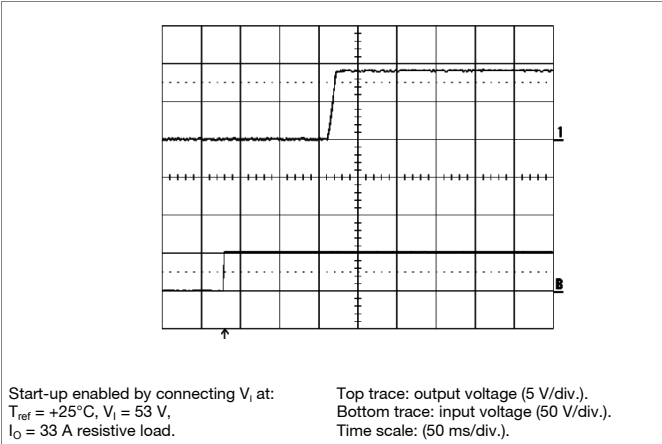

**Shut-down**

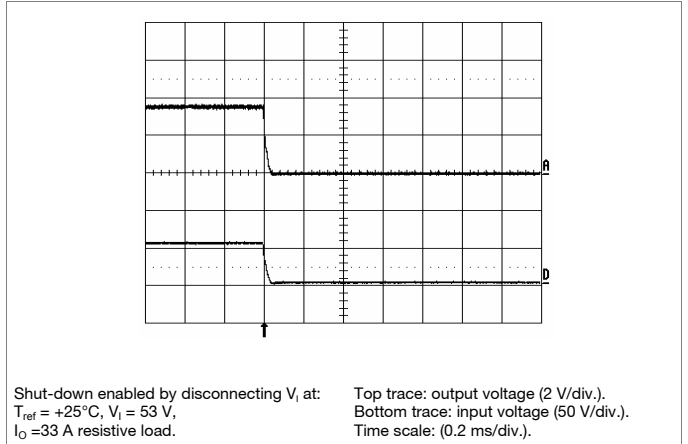

**Output Ripple & Noise**

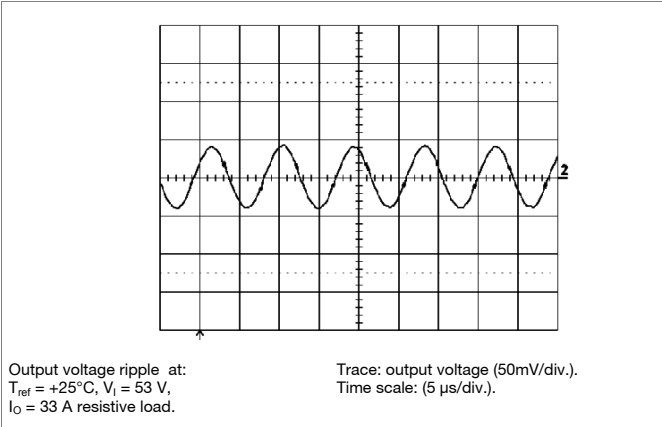

**Output Load Transient Response**

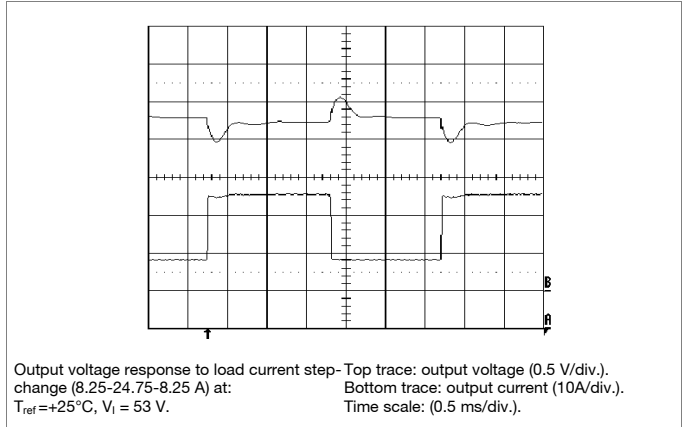



**BMR 453**  
 DC/DC Converters, Input 36-75 V, Output 33 A/400 W

EN/LZT 146 395 R1B September 2008

© Ericsson AB

**12.0V, 33A / 400W Electrical Specification**
**BMR 453 xxxx/001**
 $T_{ref} = -40$  to  $+90^{\circ}\text{C}$ ,  $V_I = 36$  to  $75$  V, sense pins connected to output pins unless otherwise specified under Conditions.

 Typical values given at:  $T_{ref} = +25^{\circ}\text{C}$ ,  $V_I = 53$  V, max  $I_O$ , unless otherwise specified under Conditions.

Configuration File: 190 10-CDA 102 935/001 rev B

Characteristics		Conditions	min	typ	max	Unit
$V_I$	Input voltage range		36		75	V
$V_{loff}$	Turn-off input voltage	Decreasing input voltage	32	33	34	V
$V_{lon}$	Turn-on input voltage	Increasing input voltage	34	35	36	V
$C_I$	Internal input capacitance			18		$\mu\text{F}$
$P_O$	Output power		0		396	W
$\eta$	Efficiency	50 % of max $I_O$		96.5		%
		max $I_O$		95.5		
		50 % of max $I_O$ , $V_I = 48$ V		96.5		
		max $I_O$ , $V_I = 48$ V		95.5		
$P_d$	Power Dissipation	max $I_O$		18.3	27.1	W
$P_{li}$	Input idling power	$I_O = 0$ A, $V_I = 53$ V		2.4		W
$P_{RC}$	Input standby power	$V_I = 53$ V (turned off with RC)		190		mW
$f_s$	Switching frequency	0-100 % of max $I_O$		140		kHz

$V_{O_i}$	Output voltage initial setting and accuracy	$T_{ref} = +25^{\circ}\text{C}$ , $V_I = 53$ V, $I_O = 33$ A	11.88	12.0	12.12	V
$V_O$	Output adjust range	See operating information	8.1		13.5	V
	Output voltage tolerance band	10-100% of max $I_O$ , see Note 1	11.76		12.24	V
	Idling voltage	$I_O = 0$ A, see Note 1	11.76		12.24	V
	Line regulation	max $I_O$ , see Note 1		23	65	mV
	Load regulation	$V_I = 53$ V, 1-100% of max $I_O$ , see Note 1		10	40	mV
$V_{tr}$	Load transient voltage deviation	$V_I = 53$ V, Load step 25-75-25 % of max $I_O$ , $di/dt = 1$ A/ $\mu\text{s}$ , $C_O = 3.3$ mF		$\pm 0.4$		V
$t_{tr}$	Load transient recovery time	see Note 2		250		$\mu\text{s}$
$t_r$	Ramp-up time (from 10–90 % of $V_{O_i}$ )	10-100% of max $I_O$ , $T_{ref} = 25^{\circ}\text{C}$ , $V_I = 53$ V		8	10	ms
$t_s$	Start-up time (from $V_I$ connection to 90% of $V_{O_i}$ )			140	150	ms
$t_f$	Vin shutdown fall time (from $V_{I,off}$ to 10% of $V_{O_i}$ )	max $I_O$		0.4		ms
		$I_O = 0$ A		7		s
$t_{RC}$	RC start-up time	max $I_O$		53		ms
	RC shutdown fall time (from RC off to 10% of $V_{O_i}$ )	max $I_O$		3.2		ms
		$I_O = 0$ A		7		s
$I_O$	Output current		0		33	A
$I_{lim}$	Current limit threshold	$V_O = 10.8$ V, $T_{ref} < \text{max } T_{ref}$	34	38	43	A
$I_{sc}$	Short circuit current	$T_{ref} = 25^{\circ}\text{C}$ , $V_O < 0.2$ V, see Note 3		45		A
$V_{Oac}$	Output ripple & noise	See ripple & noise section, max $I_O$ ,		85	220	mVp-p
OVP	Over voltage protection	$T_{ref} = +25^{\circ}\text{C}$ , $V_I = 53$ V, 10-100% of max $I_O$		15.6		V

 Note 1:  $V_{in} = 40$ -75V

Note 2: Output filter according to Ripple &amp; Noise section.

Note 3: OCP in latch mode.

**BMR 453**  
DC/DC Converters, Input 36-75 V, Output 33 A/400 W

EN/LZT 146 395 R1B September 2008

© Ericsson AB

**12.0V, 33A / 400W Electrical Specification**

**BMR 453 xxxx/001**

**Efficiency**

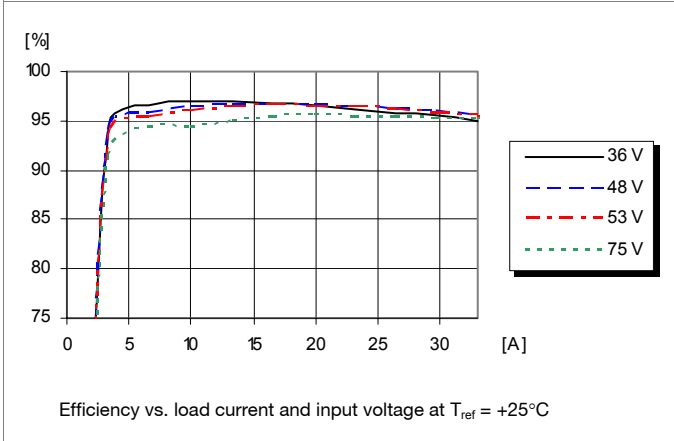

**Power Dissipation**

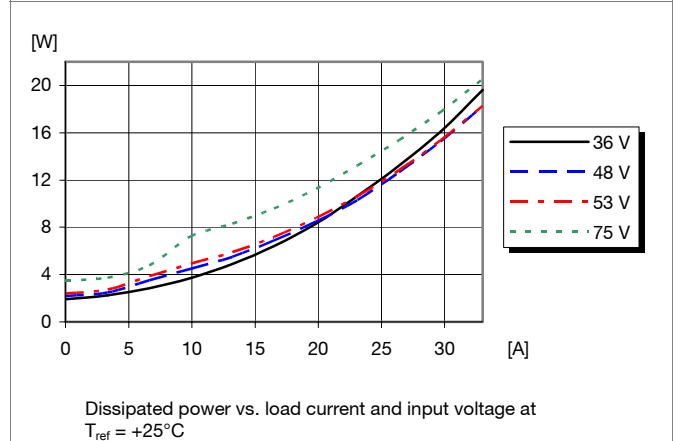

**Output Current Derating, open frame**

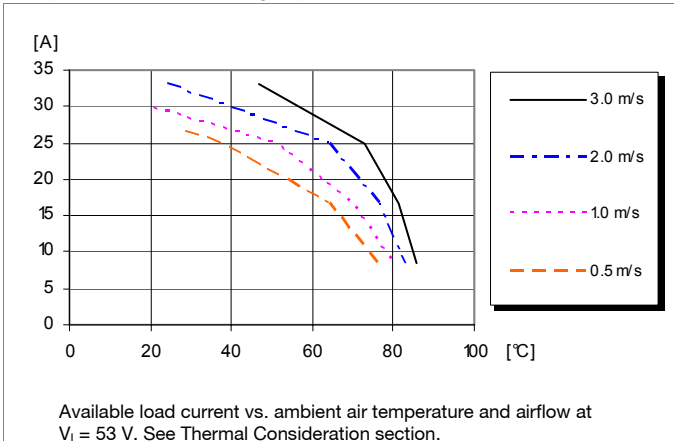

**Output Current Derating, base plate option**

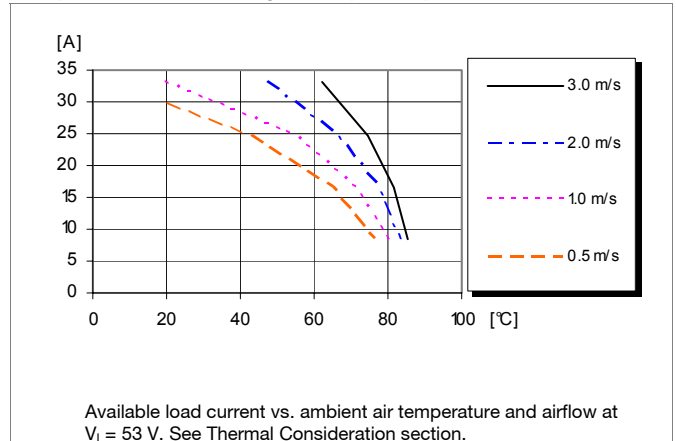

**Thermal Resistance, base plate option**

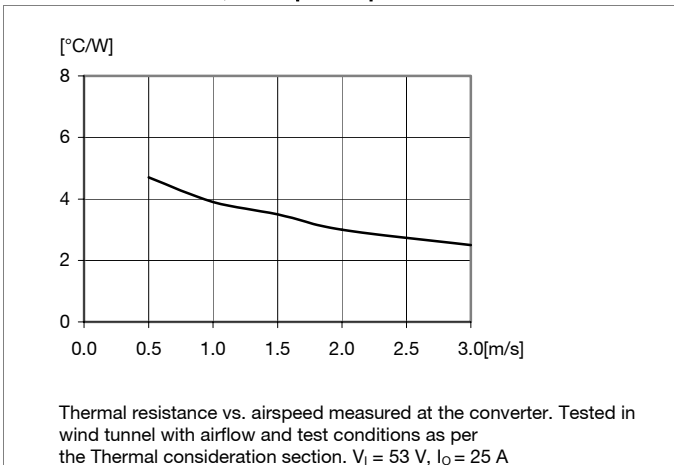

**BMR 453**  
DC/DC Converters, Input 36-75 V, Output 33 A/400 W

EN/LZT 146 395 R1B September 2008

© Ericsson AB

**12.0V, 33A / 400W Electrical Specification**

**BMR 453 xxxx/001**

**Output Characteristics**

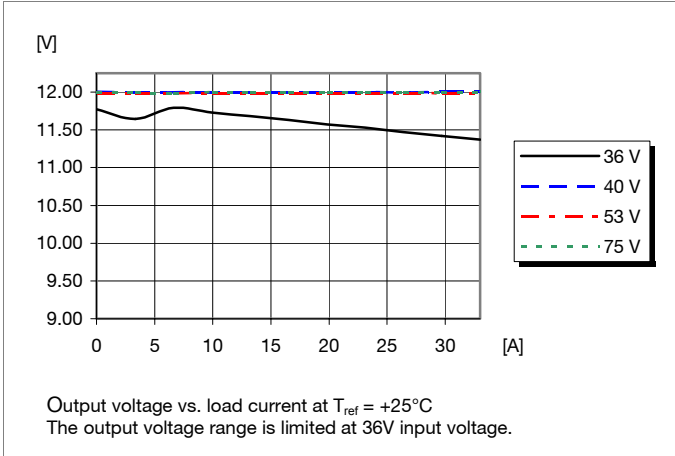

**Current Limit Characteristics**

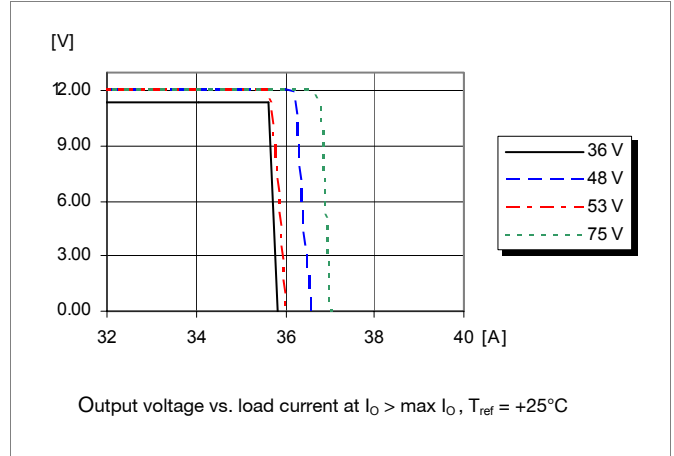

**Start-up**

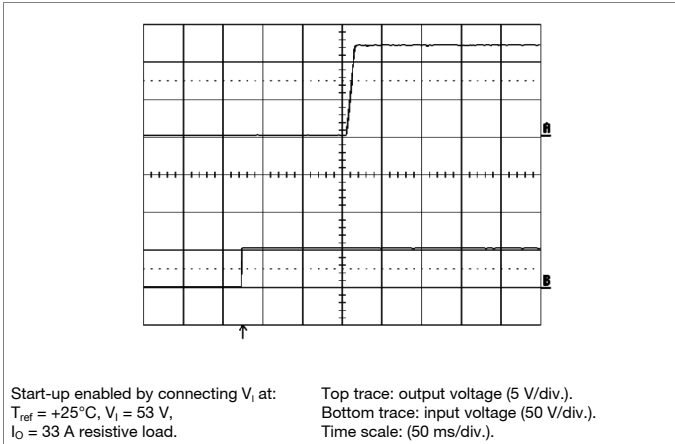

**Shut-down**

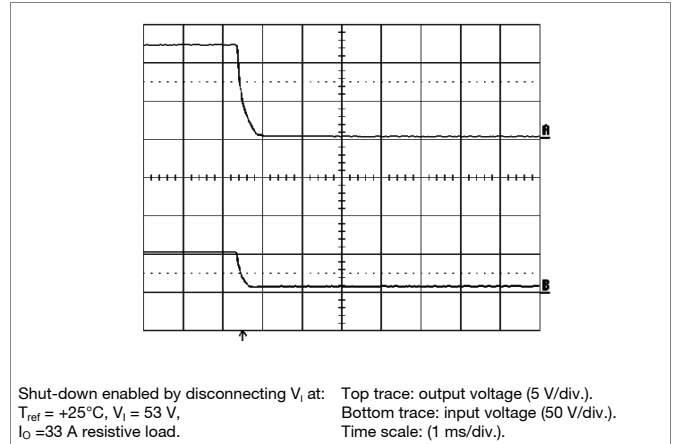

**Output Ripple & Noise**

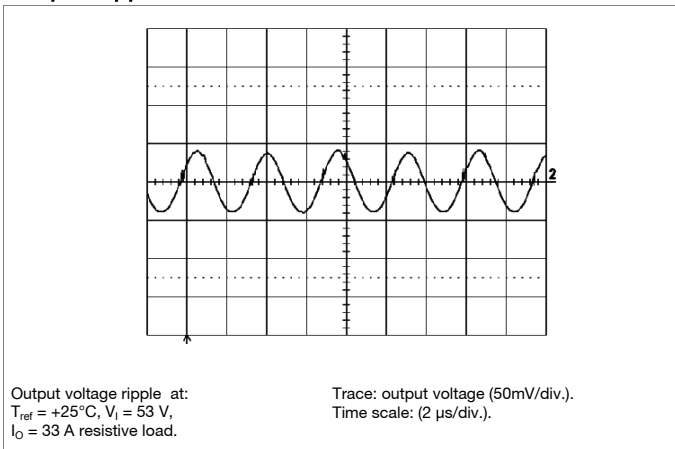

**Output Load Transient Response**

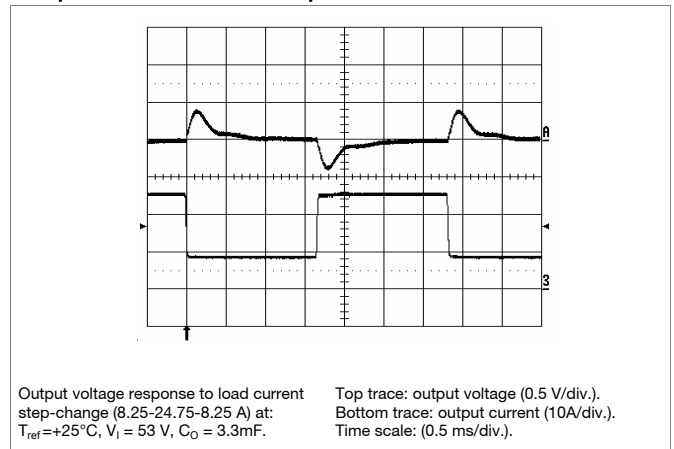

**BMR 453**  
 DC/DC Converters, Input 36-75 V, Output 33 A/400 W

EN/LZT 146 395 R1B September 2008

© Ericsson AB

**EMC Specification**

Conducted EMI measured according to EN55022, CISPR 22 and FCC part 15J (see test set-up). See Design Note 009 for further information. The fundamental switching frequency is 140 kHz for BMR 453 @  $V_1 = 53\text{ V}$ , max  $I_O$ .

**Conducted EMI Input terminal value (typ)**

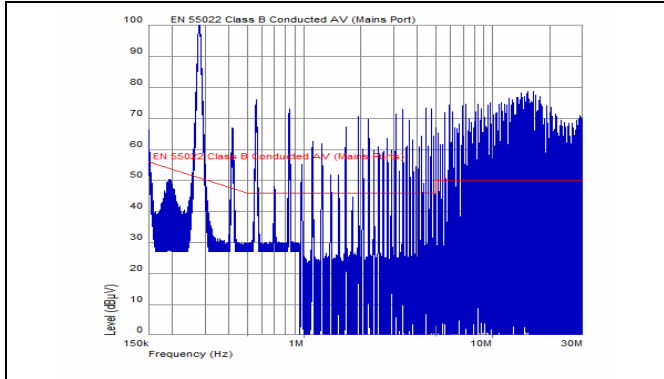

EMI without filter

**External filter (class B)**

Suggested external input filter in order to meet class B in EN 55022, CISPR 22 and FCC part 15J.

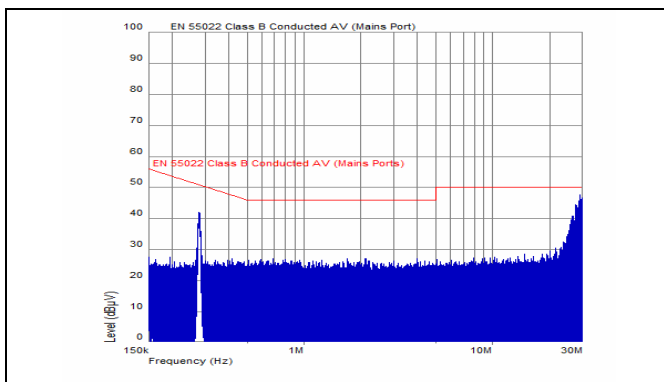
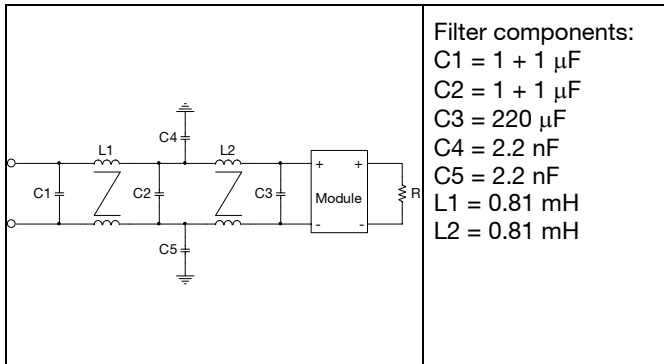

EMI with filter

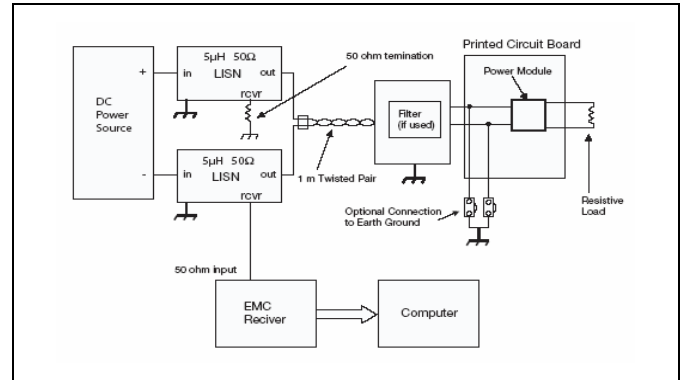

Test set-up

**Layout recommendation**

The radiated EMI performance of the DC/DC converter will depend on the PCB layout and ground layer design. It is also important to consider the stand-off of the DC/DC converter.

If a ground layer is used, it should be connected to the output of the DC/DC converter and the equipment ground or chassis.

A ground layer will increase the stray capacitance in the PCB and improve the high frequency EMC performance.

**Output ripple and noise**

Output ripple and noise measured according to figure below. See Design Note 022 for detailed information.

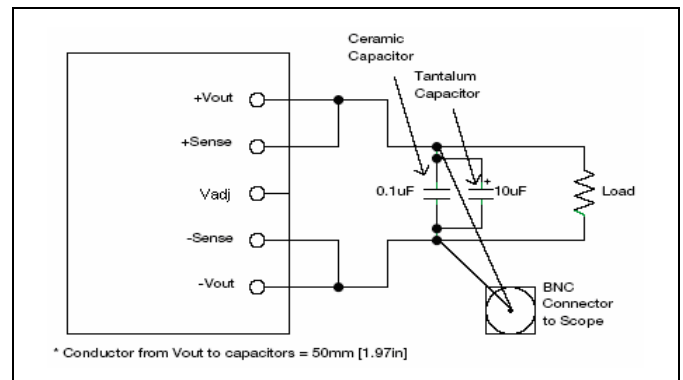

Output ripple and noise test setup

## BMR 453

DC/DC Converters, Input 36-75 V, Output 33 A/400 W

EN/LZT 146 395 R1B September 2008

© Ericsson AB

**Operating information****Input Voltage**

The input voltage range 36 to 75 Vdc meets the requirements of the European Telecom Standard ETS 300 132-2 for normal input voltage range in -48 and -60 Vdc systems, -40.5 to -57.0 V and -50.0 to -72 V respectively.

At input voltages exceeding 75 V, the power loss will be higher than at normal input voltage and  $T_{ref}$  must be limited to absolute max 125 C. The absolute maximum continuous input voltage is 80Vdc.

**Turn-off Input Voltage**

The DC/DC converters monitor the input voltage and will turn on and turn off at predetermined levels. The turn on and turn off level and the hysteresis in between can be configured via the PMBus.

The default hysteresis between turn on and turn off input voltage is set to 2 V.

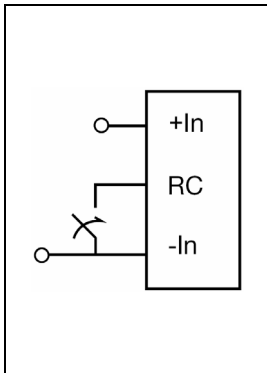
**Remote Control (RC)**

The products are fitted with a configurable remote control function. The primary remote control is referenced to the primary negative input connection (-In). The RC function allows the converter to be turned on/off by an external device like a semiconductor or mechanical switch. The RC pin has an internal pull up resistor. The remote control functions can also be configured using the PMBus.

The maximum required sink current is 1 mA. When the RC pin is left open, the voltage generated on the RC pin is max 6 V. The logic options for the primary remote control is configured using the PMBus. The default setting is negative logic.

**Input and Output Impedance**

The impedance of both the input source and the load will interact with the impedance of the DC/DC converter. It is important that the input source has low characteristic impedance. The performance in some applications can be enhanced by addition of external capacitance as described under External Decoupling Capacitors. If the input voltage source contains significant inductance, the addition of a 100  $\mu$ F capacitor across the input of the converter will ensure stable operation. The capacitor is not required when powering the DC/DC converter from an input source with an inductance below 10  $\mu$ H.

**External Decoupling Capacitors**

When powering loads with significant dynamic current requirements, the voltage regulation at the point of load can be improved by addition of decoupling capacitors at the load.

The most effective technique is to locate low ESR ceramic and electrolytic capacitors as close to the load as possible, using several parallel capacitors to lower the effective ESR. The ceramic capacitors will handle high-frequency dynamic load changes while the electrolytic capacitors are used to handle low frequency dynamic load changes. Ceramic capacitors will also reduce any high frequency noise at the load.

It is equally important to use low resistance and low inductance PCB layouts and cabling. External decoupling capacitors will become part of the control loop of the DC/DC converter and may affect the stability margins. As a "rule of thumb", 100  $\mu$ F/A of output current can be added without any additional analysis. The ESR of the capacitors is a very important parameter. Power Modules guarantee stable operation with a verified ESR value of >10 m $\Omega$  across the output connections. For further information please contact your local Ericsson Power Modules representative.

**Parallel Operation**

TBD. For further information please contact your local sales representative.

**PMBus configuration and support**

The BMR 453 DC/DC converters provide a PMBus digital interface that enables the user to configure many aspects of the device operation as well as monitor the input and output parameters. Please contact your local Ericsson Power Modules representative for appropriate SW tools to download new configurations.

**Output Voltage Adjust using PMBus**

The output voltage of the product can be reconfigured using the PMBus interface. The output voltage can be adjusted from 9V to 13.2V

**Margin Up/Down Controls**

These controls allow the output voltage to be momentarily adjusted, either up or down, by a nominal 5 %. This provides a convenient method for dynamically testing the operation of the load circuit over its supply margin or range. It can also be used to verify the function of supply voltage supervisors. The margin up and down levels of the product can be re-configured using the PMBus interface.

**Soft-start Power Up**

The soft-start control introduces a time-delay (default setting 40 ms) before allowing the output voltage to rise. The default rise time of the ramp up is 10 ms. Power-up is hence completed within 50 ms in default configuration using remote control. When starting by applying input voltage the control circuit boot-up time adds an additional 100 ms delay. The soft-start power up of the product can be reconfigured using the PMBus interface.

BMR 453

DC/DC Converters, Input 36-75 V, Output 33 A/400 W

EN/LZT 146 395 R1B September 2008

© Ericsson AB

**Operating information continued****Remote Sense**

The DC/DC converters have remote sense that can be used to compensate for voltage drops between the output and the point of load. The sense traces should be located close to the PCB ground layer to reduce noise susceptibility. The remote sense circuitry will compensate for up to 10% voltage drop between output pins and the point of load. If the remote sense is not needed +Sense should be connected to +Out and -Sense should be connected to -Out. To be able to use remote sense the converter must be equipped with a digital connector.

**Temperature Protection (OTP, UTP)**

The products are protected from thermal overload by an internal temperature shutdown protection.

When  $T_{ref}$  as defined in thermal consideration section is exceeded the product will shut down. The product will make continuous attempts to start up (non-latching mode) and resume normal operation automatically when the temperature has dropped below the temperature threshold, the hysteresis is defined in general electrical specification.

The OTP and hysteresis of the product can be re-configured using the PMBus interface. The product has also an under temperature protection. The OTP and UTP fault limit and fault response can be configured via the PMBus. Note: using the fault response "continue without interruption" may cause permanent damage of the product.

**Over Voltage Protection (OVP)**

The product has output over voltage protection that will shut down the converter in over voltage conditions (latching mode) The OVP fault level and fault response can be re-configured using the PMBus interface.

**Over Current Protection (OCP)**

The product includes current limiting circuitry for protection at continuous overload. The product will shut down if the max output current (max  $I_o$ ) is exceeded and the output voltage is below 3.6V. The load distribution should be designed for the maximum output short circuit current specified. The OCP level and fault response can be re-configured using the PMBus interface. Note: using the fault response "continue without interruption" may cause permanent damage of the product.

**Input Over/Under voltage protection**

The input of the product can be protected against high input voltage and low input voltage. The over- and under-voltage fault level and fault response can be configured via the PMBus interface.

**Pre-bias Start-up**

The product has a Pre-bias start up functionality and will not sink current during start up if a pre-bias source is present at the output terminals.

**Synchronization**

When the PG SYNC pin is configured as an input (SYNC IN) the device will automatically check for a clock signal on the PG SYNC pin each time the module is enabled by RC or via PMBus. The incoming clock signal must be 100, 125, 140, 150, 200, 250 or 300kHz and must be stable when the module is enabled. The PG SYNC pin is configured via the PMBus interface.

**Power Good**

The PG SYNC pin can be configured as an output (POWER GOOD). The power good signal (TTL level) indicates proper operation of the product and can also be used as an error flag indicator. The PG SYNC pin is configured via the PMBus interface.

**Tracking and External reference**

The PG SYNC pin can be configured as an input for voltage tracking or an external analogue reference. The PG SYNC pin is configured via the PMBus interface.

**Switching frequency adjust using PMBus**

The switching frequency is set to 140kHz as default but this can be reconfigured via the PMBus interface. The converter is optimized at this frequency but can run at lower and higher frequency. However the output performance is not specified if the frequency is changed.

**BMR 453**  
**DC/DC Converters, Input 36-75 V, Output 33 A/400 W**

EN/LZT 146 395 R1B September 2008

© Ericsson AB

**Thermal Consideration**

**General**

The converters are designed to operate in different thermal environments and sufficient cooling must be provided to ensure reliable operation. Cooling is achieved mainly by conduction, from the pins to the host board, and convection, which is dependant on the airflow across the converter. Increased airflow enhances the cooling of the converter.

The Output Current Derating graph found in the Output section for each model provides the available output current vs. ambient air temperature and air velocity at  $V_{in} = 53 V$ .

The DC/DC converter is tested on a 254 x 254 mm, 35  $\mu m$  (1 oz), 8-layer test board mounted vertically in a wind tunnel with a cross-section of 305 x 305 mm.

Proper cooling of the DC/DC converter can be verified by measuring the temperature at position P1. The temperature at these positions should not exceed the max values provided in the table below.

Note that the max value is the absolute maximum rating (non destruction) and that the electrical Output data is guaranteed up to  $T_{ref} + 90^{\circ}C$ .

See Design Note 019 for further information.

Position	Device	Designation	max value
P <sub>1</sub>	Pcb	T <sub>ref</sub>	125° C
P <sub>2</sub>	Opto-coupler	-	95° C

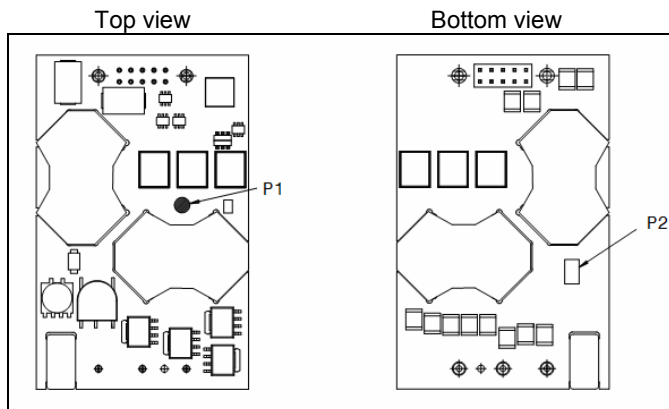

**Thermal Consideration continued**

**Definition of reference temperature (T<sub>ref</sub>)**

The reference temperature is used to monitor the temperature limits of the product. Temperatures above maximum T<sub>ref</sub> are not allowed and may cause degradation or permanent damage to the product. T<sub>ref</sub> is also used to define the temperature range for normal operating conditions. T<sub>ref</sub> is defined by the design and used to guarantee safety margins, proper operation and high reliability of the module.

**BMR 453**  
 DC/DC Converters, Input 36-75 V, Output 33 A/400 W

EN/LZT 146 395 R1B September 2008

© Ericsson AB

### Connections (Top view)

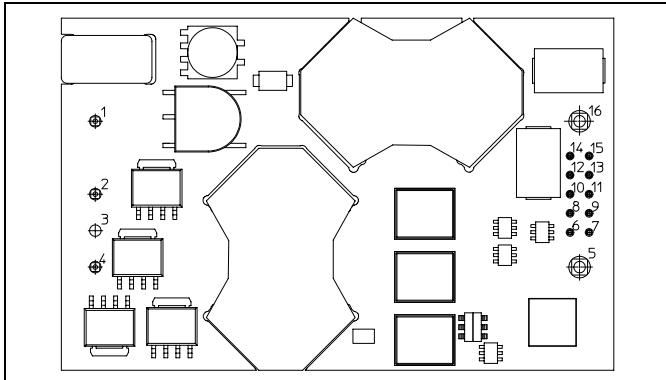

Pin	Designation	Function
1	+In	Positive Input
2	RC	Remote Control
3	Case	Case to GND (optinal)
4	-In	Negative Input
5	-Out	Negative Output
6	S+	Positive Remote Sense
7	S-	Negative Remote Sense
8	SA0	Address pin 0
9	SA1	Address pin 1
10	SCL	PMBus Clock
11	SDA	PMBus Data
12	PG SYNC	Configurable I/O pin: Power Good output, SYNC-, tracking-, or ext ref-input
13	DGND	PMBus ground
14	SALERT	PMBus alert signal
15	CTRL CS	PMBus remote control
16	+Out	Positive Output



**BMR 453**  
DC/DC Converters, Input 36-75 V, Output 33 A/400 W

EN/LZT 146 395 R1B September 2008

© Ericsson AB

**PMBus Communications**

The BMR 453 DC/DC converters provide a PMBus digital interface that enables the user to configure many aspects of the device operation as well as monitor the input and output parameters. The products can be used with any standard 2-wire I<sup>2</sup>C or SMBus host device. In addition, the device is compatible with PMBus version 1.1 and includes an SALERT line to help mitigate bandwidth limitations related to continuous fault monitoring.

**Monitoring via PMBus**

A system controller can monitor a wide variety of different parameters through the PMBus interface. The controller can monitor for fault condition by monitoring the SALERT pin, which will be asserted when any number of pre-configured fault or warning conditions occur. The system controller can also continuously monitor for any number of power conversion parameters including but not limited to the following:

- Input voltage
- Output voltage
- Output current
- Internal junction temperature
- Switching frequency
- Duty cycle

**Evaluation software**

For the DC/DC converter Ericsson provides an evaluation software, CMM. For more information please contact your local Ericsson sales representative.

**Addressing**

The figure and table below show recommended resistor values with min and max voltage range for hard-wiring PMBus addresses (series E96, 1% tolerance resistors suggested):

SA0/SA1	R <sub>1</sub> /R <sub>0</sub> [kΩ]	Min voltage[V]	Max voltage[V]
0	24.9	0.261	0.438
1	49.9	0.524	0.679
2	75	0.749	0.871
3	100	0.926	1.024
4	124	1.065	1.146
5	150	1.187	1.256
6	174	1.285	1.345
7	200	1.371	1.428

The SA0 and SA1 pins can be configured with a resistor to GND according to the following equation.

$$\text{PMBus Address} = 8 \times (\text{SA0value}) + (\text{SA1 value})$$

If any one of those voltage applied to ADC0 and ADC1 is out of the range from the table above, PMBus address 127 is assigned. If the calculated PMBus address is 0 or 12, PMBus address 127 is assigned instead. PMBus address 11 is not to be used. The user shall also be aware of further limitations of the addresses as stated in the PMBus Specification.

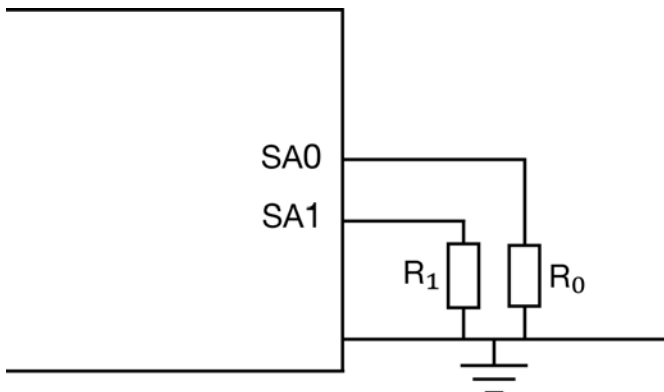

BMR 453  
DC/DC Converters, Input 36-75 V, Output 33 A/400 W

EN/LZT 146 395 R1B September 2008

© Ericsson AB

### PMBus Commands

The DC/DC converter is PMBUS compliant. The following table lists the implemented PMBus commands. For more detailed information see PMBus Power System Management Protocol Specification; Part I – General Requirements, Transport and Electrical Interface and PMBus Power System Management Protocol; Part II – Command Language.

Designation	Cmd	Impl
<b>Standard PMBus Commands</b>		
<b>Control Commands</b>		
PAGE	00h	No
OPERATION	01h	Yes
ON_OFF_CONFIG	02h	Yes
WRITE_PROTECT	10h	Yes
<b>Output Commands</b>		
VOUT_MODE	20h	Yes
VOUT_COMMAND	21h	Yes
VOUT_TRIM	22h	Yes
VOUT_GAIN	23h	Yes
VOUT_MAX	24h	Yes
VOUT_MARGIN_HIGH	25h	Yes
VOUT_MARGIN_LOW	26h	Yes
VOUT_TRANSITION_RATE	27h	Yes
VOUT_DROOP	28h	No
VOUT_SCALE_LOOP	29h	Yes
VOUT_SCALE_MONITOR	2Ah	Yes
COEFFICIENTS	30h	No
POUT_MAX	31h	No
MAX_DUTY	32h	Yes
FREQUENCY_SWITCH	33h	Yes
VIN_ON	35h	Yes
VIN_OFF	36h	Yes
IOUT_CAL_GAIN	38h	Yes
IOUT_CAL_OFFSET	39h	Yes
<b>Fault Limit Commands</b>		
POWER_GOOD_ON	5Eh	Yes
POWER_GOOD_OFF	5Fh	Yes
VOUT_OV_FAULT_LIMIT	40h	Yes
VOUT_UV_FAULT_LIMIT	44h	Yes
IOUT_OC_FAULT_LIMIT	46h	Yes
IOUT_OC_LV_FAULT_LIMIT	48h	Yes
IOUT_UC_FAULT_LIMIT	4Bh	No
OT_FAULT_LIMIT	4Fh	Yes

OT_WARN_LIMIT	51h	Yes
UT_WARN_LIMIT	52h	Yes
UT_FAULT_LIMIT	53h	Yes
VIN_OV_FAULT_LIMIT	55h	Yes
VIN_OV_WARN_LIMIT	57h	Yes
VIN_UV_WARN_LIMIT	58h	Yes
VIN_UV_FAULT_LIMIT	59h	Yes
VOUT_OV_WARN_LIMIT	42h	Yes
VOUT_UV_WARN_LIMIT	43h	Yes
IOUT_OC_WARN_LIMIT	4Ah	Yes
IIN_OC_FAULT_LIMIT	5Bh	No
IIN_OC_WARN_LIMIT	5Dh	No
<b>Fault Response Commands</b>		
VOUT_OV_FAULT_RESPONSE	41h	Yes
VOUT_UV_FAULT_RESPONSE	45h	Yes
OT_FAULT_RESPONSE	50h	Yes
UT_FAULT_RESPONSE	54h	Yes
VIN_OV_FAULT_RESPONSE	56h	Yes
VIN_UV_FAULT_RESPONSE	5Ah	Yes
IOUT_OC_FAULT_RESPONSE	47h	Yes
IOUT_UC_FAULT_RESPONSE	4Ch	No
IIN_OC_FAULT_RESPONSE	5Ch	No
<b>Time setting Commands</b>		
TON_DELAY	60h	Yes
TON_RISE	61h	Yes
TON_MAX_FAULT_LIMIT	62h	Yes
TON_MAX_FAULT_RESPONSE	63h	Yes
TOFF_DELAY	64h	Yes
TOFF_FALL	65h	Yes
TOFF_MAX_WARN_LIMIT	66h	Yes
<b>Status Commands (Read Only)</b>		
CLEAR_FAULTS	03h	Yes
STATUS_BYTES	78h	Yes
STATUS_WORD	79h	Yes
STATUS_VOUT	7Ah	Yes
STATUS_IOUT	7Bh	Yes
STATUS_INPUT	7Ch	Yes
STATUS_TEMPERATURE	7Dh	Yes
STATUS_CML	7Eh	Yes
STATUS_OTHER	7Fh	Yes
<b>Monitor Commands (Read Only)</b>		
READ_VIN	88h	Yes

BMR 453  
DC/DC Converters, Input 36-75 V, Output 33 A/400 W

EN/LZT 146 395 R1B September 2008

© Ericsson AB

READ_VOUT	8Bh	Yes
READ_IOUT	8Ch	Yes
READ_TEMPERATURE_1	8Dh	Yes
READ_TEMPERATURE_2	8Eh	Yes
READ_FAN_SPEED_1	90h	No
READ_DUTY_CYCLE	94h	Yes
READ_FREQUENCY	95h	Yes
READ_POUT	96h	No
READ_PIN	97h	No
Identification Commands (Read Only)		
PMBUS_REVISION	98h	Yes
MFR_ID	99h	Yes
MFR_MODEL	9Ah	Yes
MFR_REVISION	9Bh	Yes
MFR_LOCATION	9Ch	Yes
MFR_DATE	9Dh	Yes
MFR_SERIAL	9Eh	Yes
Group Commands		
INTERLEAVE	37h	No
Supervisory Commands		
STORE_DEFAULT_ALL	11h	Yes
RESTORE_DEFAULT_ALL	12h	Yes
STORE_USER_ALL	15h	Yes
RESTORE_USER_ALL	16h	Yes
<b>BMR 453 Specific Commands</b>		
MFR_POWER_GOOD_POLARITY	D0h	Yes
MFR_VOUT_UPPER_RESISTOR	D2h	Yes
MFR_VIN_SCALE_MONITOR	D3h	Yes
MFR_CLA_TABLE_NUM_ROW	D4h	Yes
MFR_CLA_ROW_COEFFICIENTS	D5h	Yes
MFR_STORE_CLA_TABLE	D6h	Yes
MFR_ACTIVE_COEFF_CLA_TABLE	D8h	Yes
MFR_SELECT_TEMP_SENSOR	DCh	Yes
MFR_VIN_OFFSET	DDh	Yes
MFR_REMOTE_TEMP_CAL	E2h	Yes
MFR_REMOTE_CONTROL	E3h	Yes
MFR_DEAD_BAND_MODE	E4h	Yes
MFR_DEAD_BAND_DELAY	E5h	Yes
MFR_TEMP_COEFF	E7h	Yes
MFR_VOUT_ANALOG_SCALE	E8h	Yes
MFR_READ_VOUT_ANALOG_REF	E9h	Yes
MFR_DEBUG_BUFF	F0h	Yes

Designation	Cmd	Impl
MFR_SETUP_PASSWORD	F1h	Yes
MFR_DISABLE_SECURITY	F2h	Yes
MFR_DEAD_BAND_IOUT_THRESHOLD	F3h	Yes
MFR_SECURITY_BIT_MASK	F4h	Yes
MFR_PRIMARY_TURN	F5h	Yes
MFR_SECONDARY_TURN	F6h	Yes
MFR_SET_DPWM_POLARITY	F7h	Yes
MFR_ILIM_SOFTSTART	F8h	Yes
MFR_MULTI_PIN_CONFIG	F9h	Yes
MFR_DEAD_BAND_VIN_THRESHOLD	FAh	Yes
MFR_DEAD_BAND_VIN_IOUT_HYS	FBh	Yes
MFR_FIRMWARE_VERSION	FCh	Yes
MFR_MESSAGE_CODE_DEVICE_ID	FDh	Yes

Notes:

Cmd is short for Command.

Impl is short for Implemented.

**BMR 453**  
DC/DC Converters, Input 36-75 V, Output 33 A/400 W

EN/LZT 146 395 R1B September 2008

© Ericsson AB

**Mechanical Information – Hole Mount, Open Frame Version**



TOP VIEW

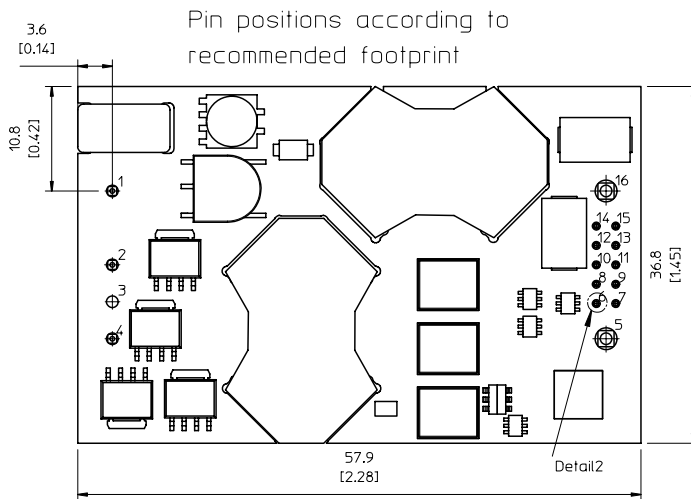
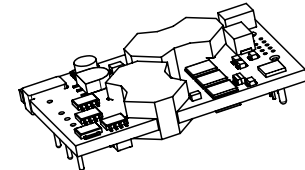

RECOMMENDED FOOTPRINT - TOP VIEW

X1	Lead length
0	5.33 [0.210]
2	3.69 [0.145] (cut)
3	4.57 [0.180] (cut)
4	2.79 [0.110] (cut)
5	2.79 [0.110]

Table 1.  
X1 = Ordering information

**PIN SPECIFICATIONS**  
Pin 1,2,4,5 & 16 Material: Copper alloy  
Plating: Min Au 0.1 µm over 1-3 µm Ni.  
Pin 6-15 Material: Brass  
Plating: Min Au 0.2 µm over 1.3 µm Ni

**NOTE:**  
Pin 6-15 are optional and only used if digital communication is requested.

X1-5 Are special customer pins with extra stand off 6.7 mm & Max Height 17 mm.

Position 3 is only used for base plate GND connection pin.

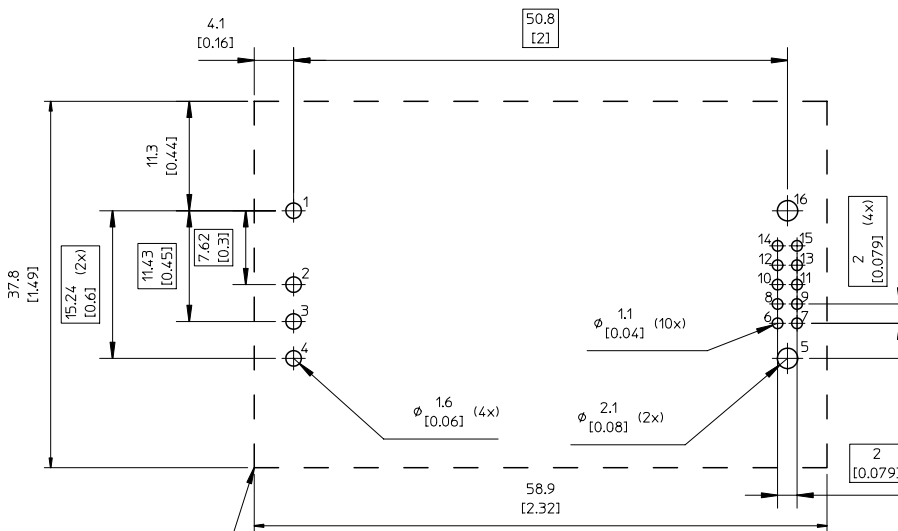

Recommended keep away area for user components.  
The stand-off in combination with insulating material ensures that requirements as per IEC/EN/UL60950 are met and 1500 V isolation maintained even if open vias or traces are present under the DC/DC converter.

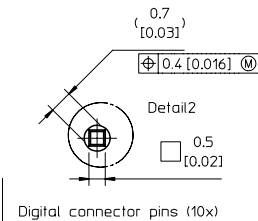

Weight: Typical 48 g  
All dimensions in mm [inch].  
Tolerances unless specified:  
x.x +0.50 [0.02], x.xx+0.25 [0.01]  
(not applied on footprint or typical values)



**BMR 453**  
DC/DC Converters, Input 36-75 V, Output 33 A/400 W

EN/LZT 146 395 R1B September 2008

© Ericsson AB

**Mechanical Information – Through Hole Mount – Base plate version**

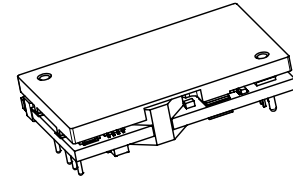
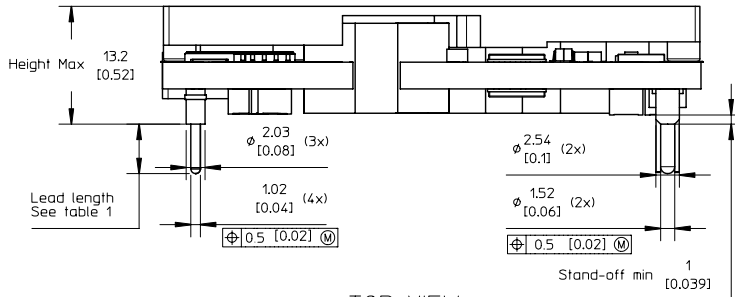

TOP VIEW

Pin positions according to recommended footprint

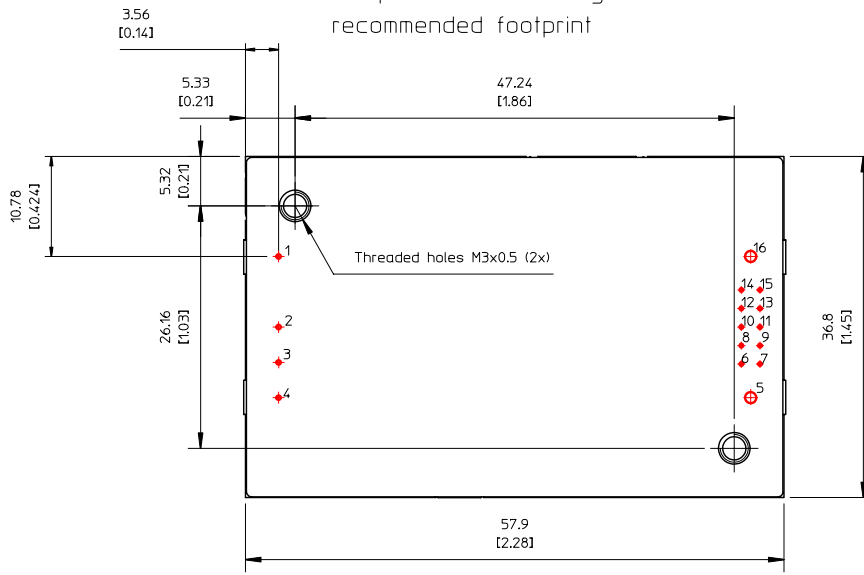

RECOMMENDED FOOTPRINT - TOP VIEW

X1	Lead length
0	5.33 [0.210]
2	3.69 [0.145] (cut)
3	4.57 [0.180] (cut)
4	2.79 [0.110] (cut)
5	2.79 [0.110]

Table 1.

X1 = Ordering information

CASE

Material: Aluminium  
For screw attachment apply mounting torque of max 0.44 Nm [3.9 lbf in], M3 screws must not protrude more than 2.7 mm [0.106] in to the base plate.

PIN SPECIFICATIONS

Pin 1,2,3,4,5 & 16 Material: Copper Alloy  
Plating: Min Au 0.1µm over 1-3µm Ni.  
Pin 6-15 Material: Brass  
Plating: Min Au 0.2µm over 1.3µm Ni.

NOTE

Pin 6-15 are optional and only used if digital communication is requested.  
Pin 3 is only used for baseplate GND connection.  
X1-5 Are special customer pins with extra stand off 6.7 mm & Max height 18.9 mm.

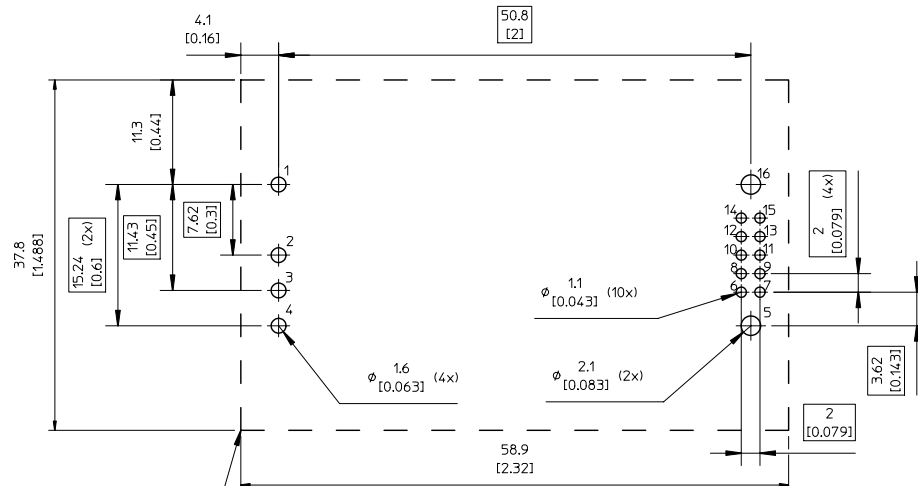

Recommended keep away area for user components.

The stand-off in combination with insulating material ensures that requirements as per IEC/EN/UL60950 are met and 1500 V isolation maintained even if open vias or traces are present under the DC/DC converter.

Weight: Typical 67 g

All dimensions in mm [inch].  
Tolerances unless specified:  
x.x ±0.50 [0.02], x.xx±0.25 [0.01]  
(not applied on footprint or typical values)



**BMR 453**  
 DC/DC Converters, Input 36-75 V, Output 33 A/400 W

EN/LZT 146 395 R1B September 2008

© Ericsson AB

**Soldering Information – Hole Mounting**

The hole mounted product is intended for plated through hole mounting by wave or manual soldering. The pin temperature is specified to maximum to 270°C for maximum 10 seconds.

A maximum preheat rate of 4°C/s and maximum preheat temperature of 150°C is suggested. When soldering by hand, care should be taken to avoid direct contact between the hot soldering iron tip and the pins for more than a few seconds in order to prevent overheating.

A no-clean flux is recommended to avoid entrapment of cleaning fluids in cavities inside the product or between the product and the host board. The cleaning residues may affect long time reliability and isolation voltage.

**Delivery package information**

The products are delivered in antistatic trays.

Tray specifications	
<b>Material</b>	PE foam, dissipative
<b>Surface resistance</b>	10 <sup>5</sup> to 10 <sup>12</sup> ohms/square
<b>Tray capacity</b>	20 converters/tray
<b>Box capacity</b>	20 converters
<b>Weight</b>	Product - Open frame 1100 g full tray, 140 g empty tray Product – Base plate option 1480 g full tray, 140 g empty tray

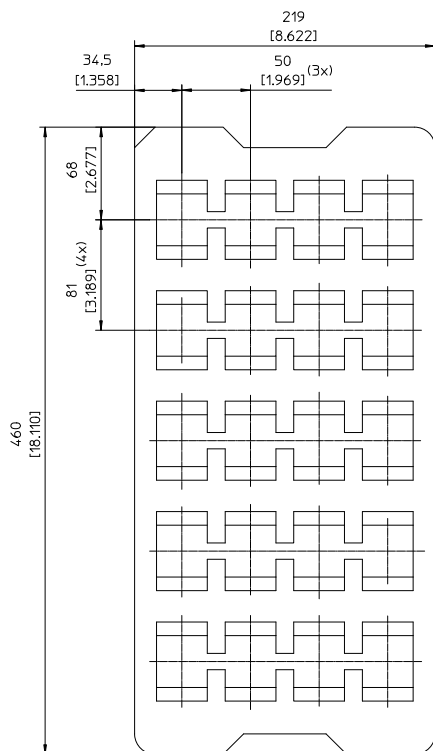

BMR 453 DC/DC Converters, Input 36-75 V, Output 33 A/400 W	EN/LZT 146 395 R1B September 2008
	© Ericsson AB

## Product Qualification Specification

Characteristics			
External visual inspection	IPC-A-610		
Change of temperature (Temperature cycling)	IEC 60068-2-14 Na	Temperature range Number of cycles Dwell/transfer time	-40 to 100°C 1000 15 min/0-1 min
Cold (in operation)	IEC 60068-2-1 Ad	Temperature T <sub>A</sub> Duration	-45°C 72 h
Damp heat	IEC 60068-2-67 Cy	Temperature Humidity Duration	85°C 85 % RH 1000 hours
Dry heat	IEC 60068-2-2 Bd	Temperature Duration	125°C 1000 h
Electrostatic discharge susceptibility	IEC 61340-3-1, JESD 22-A114 IEC 61340-3-2, JESD 22-A115	Human body model (HBM) Machine Model (MM)	Class 2, 2000 V Class 3, 200 V
Immersion in cleaning solvents	IEC 60068-2-45 XA, method 2	Water Glycol ether Isopropyl alcohol	55°C 35°C 35°C
Mechanical shock	IEC 60068-2-27 Ea	Peak acceleration Duration	100 g 6 ms
Moisture reflow sensitivity <sup>1</sup>	J-STD-020C	Level 1 (SnPb-eutectic) Level 3 (Pb Free)	225°C 260°C
Operational life test	MIL-STD-202G, method 108A	Duration	1000 h
Resistance to soldering heat <sup>2</sup>	IEC 60068-2-20 Tb, method 1A	Solder temperature Duration	270°C 10-13 s
Robustness of terminations	IEC 60068-2-21 Test Ua1 IEC 60068-2-21 Test Ue1	Through hole mount products Surface mount products	All leads All leads
Solderability	IEC 60068-2-58 test Td <sup>1</sup>	Preconditioning Temperature, SnPb Eutectic Temperature, Pb-free	150°C dry bake 16 h 215°C 235°C
	IEC 60068-2-20 test Ta <sup>2</sup>	Preconditioning Temperature, SnPb Eutectic Temperature, Pb-free	Steam ageing 235°C 245°C
Vibration, broad band random	IEC 60068-2-64 Fh, method 1	Frequency Spectral density Duration	10 to 500 Hz 0.07 g <sup>2</sup> /Hz 10 min in each direction

## Notes

<sup>1</sup> Only for products intended for reflow soldering (surface mount products)

<sup>2</sup> Only for products intended for wave soldering (plated through hole products)