

PKB4000C PI  
DC/DC converters, Input 36-75 V, Output 60A/144W

EN/LZT 146 377 R3G Oct 2008

© Ericsson Power Modules AB

**Key Features**

- Industry standard low profile Eighth-brick  
58.4 x 22.7 x 8.6 mm (2.3 x 0.89 x 0.34 in.)
- High efficiency, typ. 91 % at 3.3V/40A
- 1500 Vdc input to output isolation
- Meets isolation requirements equivalent to basic insulation according to IEC/EN/UL 60950
- More than 1 million hours MTBF

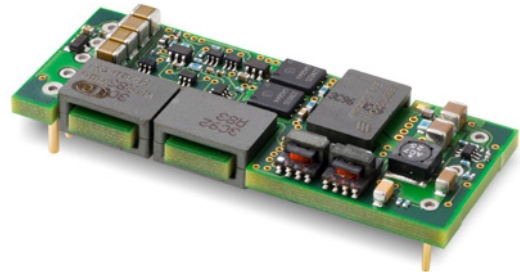

**General Characteristics**

- Suited for narrow board pitch applications (15 mm/0.6 in)
- Secondary side control for tighter regulation
- Over temperature protection
- Over current protection
- Over voltage protection
- Optional latching OVP, OCP, OTP
- Monotonic startup
- Start up into Pre-biased load
- Remote sense
- Remote control
- Output voltage adjust function
- Through hole and surface mount option
- Optional baseplate
- Highly automated manufacturing ensures quality
- ISO 9001/14001 certified supplier

**Safety Approvals**



**Design for Environment**



Meets requirements in high-temperature lead-free soldering processes.

**Contents**

General Information	.....	2	
Safety Specification	.....	3	
Absolute Maximum Ratings	.....	4	
Product Program		Ordering No.	
1.2V, 60A / 72W Electrical Specification		PKB 4718LC PI.....	5
1.5V, 60A / 90W Electrical Specification		PKB 4918HC PI .....	9
1.8V, 60A / 108W Electrical Specification		PKB 4118GC PI .....	13
3.3V, 40A / 132W Electrical Specification		PKB 4110C PI.....	17
5.0V, 28A / 140W Electrical Specification		PKB 4111C PI.....	21
12.0V, 12A / 144W Electrical Specification		PKB 4113C PI.....	25
EMC Specification	.....	29	
Operating Information	.....	30	
Thermal considerations	.....	32	
Connections	.....	33	
Mechanical Information	.....	34	
Soldering Information	.....	37	
Delivery Information	.....	38	
Product Qualification Specification	.....	39	

PKB4000C PI DC/DC converters, Input 36-75 V, Output 60A/144W	EN/LZT 146 377 R3G Oct 2008
	© Ericsson Power Modules AB

## General Information

### Ordering Information

See Contents for individual product ordering numbers.

Option	Suffix	Ordering No.
Surface mount	SI	PKB 4110C SI
Positive Remote Control Logic	P	PKB 4110C PIP
Latching OCP	LI	PKB 4110C PILI
Latching OTP	LT	PKB 4110C PILT
Latching OVP	LV	PKB 4110C PILV
Latching OTP and OVP	LP	PKB 4110C PILP
Latching OCP and OTP	LIT	PKB 4110C PILIT
Latching OCP and OVP	LIV	PKB 4110C PILIV
All protection features latching	LPA	PKB 4110C PILPA
Increased Stand-off height	M	PKB 4110C PIM
Lead length 3.69 mm (0.145 in)	LA	PKB 4110C PILA
Lead length 4.57 mm (0.180 in)	LB	PKB 4110C PILB
Baseplate	HS	PKB 4110C PIHS

Note: As an example a positive logic, short pin, latching OVP, baseplate product would be PKB 4110C PIPLVHSLA.

### Reliability

The Mean Time Between Failure (MTBF) is calculated at full output power and an operating ambient temperature ( $T_A$ ) of +40°C, which is a typical condition in Information and Communication Technology (ICT) equipment. Different methods could be used to calculate the predicted MTBF and failure rate which may give different results. Ericsson Power Modules currently uses Telcordia SR332.

Predicted MTBF for the series is:

- 1 million hours according to Telcordia SR332, issue 1, Black box technique.

Telcordia SR332 is a commonly used standard method intended for reliability calculations in ICT equipment. The parts count procedure used in this method was originally modelled on the methods from MIL-HDBK-217F, Reliability Predictions of Electronic Equipment. It assumes that no reliability data is available on the actual units and devices for which the predictions are to be made, i.e. all predictions are based on generic reliability parameters.

### Compatibility with RoHS requirements

The products are compatible with the relevant clauses and requirements of the RoHS directive 2002/95/EC and have a maximum concentration value of 0.1% by weight in homogeneous materials for lead, mercury, hexavalent chromium, PBB and PBDE and of 0.01% by weight in homogeneous materials for cadmium.

Exemptions in the RoHS directive utilized in Ericsson Power Modules products include:

- Lead in high melting temperature type solder (used to solder the die in semiconductor packages)
- Lead in glass of electronics components and in electronic ceramic parts (e.g. fill material in chip resistors)
- Lead as an alloying element in copper alloy containing up to 4% lead by weight (used in connection pins made of Brass)

### Quality Statement

The products are designed and manufactured in an industrial environment where quality systems and methods like ISO 9000, 6 $\sigma$  (sigma), and SPC are intensively in use to boost the continuous improvements strategy. Infant mortality or early failures in the products are screened out and they are subjected to an ATE-based final test. Conservative design rules, design reviews and product qualifications, plus the high competence of an engaged work force, contribute to the high quality of our products.

### Warranty

Warranty period and conditions are defined in Ericsson Power Modules General Terms and Conditions of Sale.

### Limitation of Liability

Ericsson Power Modules does not make any other warranties, expressed or implied including any warranty of merchantability or fitness for a particular purpose (including, but not limited to, use in life support applications, where malfunctions of product can cause injury to a person's health or life).

PKB4000C PI DC/DC converters, Input 36-75 V, Output 60A/144W	EN/LZT 146 377 R3G Oct 2008
	© Ericsson Power Modules AB

## Safety Specification

### General information

Ericsson Power Modules DC/DC converters and DC/DC regulators are designed in accordance with safety standards IEC/EN/UL60950, *Safety of Information Technology Equipment*.

IEC/EN/UL60950 contains requirements to prevent injury or damage due to the following hazards:

- Electrical shock
- Energy hazards
- Fire
- Mechanical and heat hazards
- Radiation hazards
- Chemical hazards

On-board DC-DC converters and DC/DC regulators are defined as component power supplies. As components they cannot fully comply with the provisions of any Safety requirements without "Conditions of Acceptability". Clearance between conductors and between conductive parts of the component power supply and conductors on the board in the final product must meet the applicable Safety requirements. Certain conditions of acceptability apply for component power supplies with limited stand-off (see Mechanical Information for further information). It is the responsibility of the installer to ensure that the final product housing these components complies with the requirements of all applicable Safety standards and Directives for the final product.

Component power supplies for general use should comply with the requirements in IEC60950, EN60950 and UL60950 "*Safety of information technology equipment*". There are other more product related standards, e.g. IEEE802.3af "Ethernet LAN/MAN Data terminal equipment power", and ETS300132-2 "Power supply interface at the input to telecommunications equipment; part 2: DC", but all of these standards are based on IEC/EN/UL60950 with regards to safety.

Ericsson Power Modules DC/DC converters and DC/DC regulators are UL60950 recognized and certified in accordance with EN60950.

The flammability rating for all construction parts of the products meets requirements for V-0 class material according to IEC 60695-11-10.

The products should be installed in the end-use equipment, in accordance with the requirements of the ultimate application. Normally the output of the DC/DC converter is considered as SELV (Safety Extra Low Voltage) and the input source must be isolated by minimum Double or Reinforced Insulation from the primary circuit (AC mains) in accordance with IEC/EN/UL60950.

### Isolated DC/DC converters

It is recommended that a slow blow fuse with a rating twice the maximum input current per selected product be used at the input of each DC/DC converter. If an input filter is used in the circuit the fuse should be placed in front of the input filter.

In the rare event of a component problem in the input filter or in the DC/DC converter that imposes a short circuit on the input source, this fuse will provide the following functions:

- Isolate the faulty DC/DC converter from the input power source so as not to affect the operation of other parts of the system.
- Protect the distribution wiring from excessive current and power loss thus preventing hazardous overheating.

The galvanic isolation is verified in an electric strength test. The test voltage ( $V_{iso}$ ) between input and output is 1500 Vdc or 2250 Vdc for 60 seconds (refer to product specification).

Leakage current is less than 1  $\mu$ A at nominal input voltage.

### 24 V DC systems

The input voltage to the DC/DC converter is SELV (Safety Extra Low Voltage) and the output remains SELV under normal and abnormal operating conditions.

### 48 and 60 V DC systems

If the input voltage to the DC/DC converter is 75 Vdc or less, then the output remains SELV (Safety Extra Low Voltage) under normal and abnormal operating conditions.

Single fault testing in the input power supply circuit should be performed with the DC/DC converter connected to demonstrate that the input voltage does not exceed 75 Vdc.

If the input power source circuit is a DC power system, the source may be treated as a TNV2 circuit and testing has demonstrated compliance with SELV limits and isolation requirements equivalent to Basic Insulation in accordance with IEC/EN/UL60950.

### Non-isolated DC/DC regulators

The input voltage to the DC/DC regulator is SELV (Safety Extra Low Voltage) and the output remains SELV under normal and abnormal operating conditions.

PKB4000C PI  
DC/DC converters, Input 36-75 V, Output 60A/144W

EN/LZT 146 377 R3G Oct 2008

© Ericsson Power Modules AB

**Absolute Maximum Ratings**

Characteristics		min	typ	max	Unit
$T_{ref}$	Operating Temperature (see Thermal Consideration section)	-40		+125	°C
$T_s$	Storage temperature	-55		+125	°C
$V_I$	Input voltage	-0.5		+80	V
$V_{iso}$	Isolation voltage (input to output test voltage), see note 1			1500	Vdc
$V_{tr}$	Input voltage transient (Tp 100 ms)			100	V
$V_{RC}$	Remote Control pin voltage (see Operating Information section)	Positive logic option	0	16	V
		Negative logic option	0	16	V
$V_{adj}$	Adjust pin voltage (see Operating Information section)	-0.5		$2 \times V_{oi}$	V

Stress in excess of Absolute Maximum Ratings may cause permanent damage. Absolute Maximum Ratings, sometimes referred to as no destruction limits, are normally tested with one parameter at a time exceeding the limits of Output data or Electrical Characteristics. If exposed to stress above these limits, function and performance may degrade in an unspecified manner.

Note 1: Isolation voltage (input/output to base-plate) max 750Vdc.

**Fundamental Circuit Diagram**

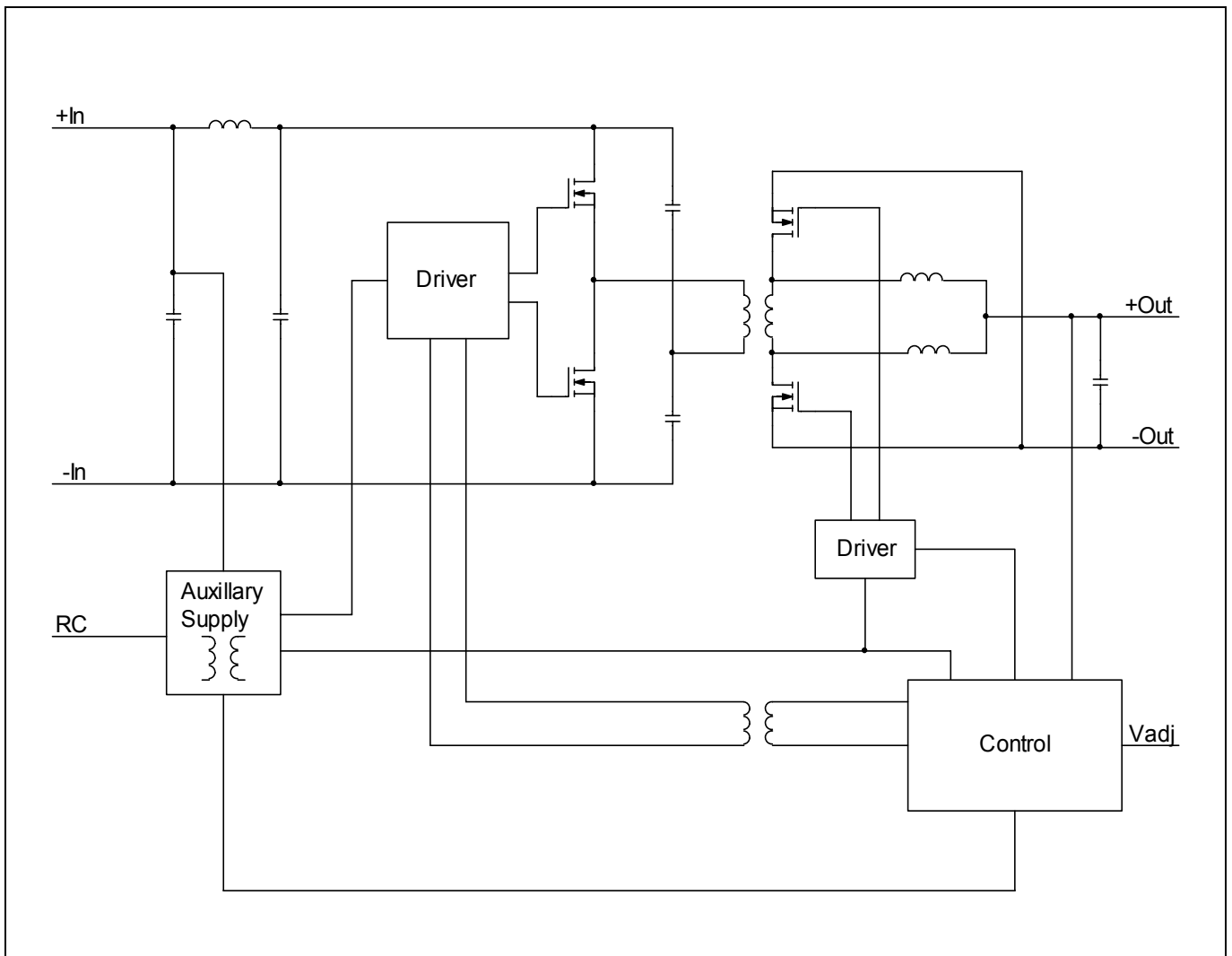

PKB4000C PI DC/DC converters, Input 36-75 V, Output 60A/144W	EN/LZT 146 377 R3G Oct 2008
	© Ericsson Power Modules AB

**1.2 V/60 A Electrical Specification**
**PKB 4718LC PI**

$T_{ref} = -40$  to  $+90^{\circ}\text{C}$ ,  $V_I = 36$  to  $75$  V, sense pins connected to output pins unless otherwise specified under Conditions.

Typical values given at:  $T_{ref} = +25^{\circ}\text{C}$ ,  $V_I = 53$  V, max  $I_O$ , unless otherwise specified under Conditions.

Characteristics		Conditions	min	typ	max	Unit
$V_I$	Input voltage range		36		75	V
$V_{loff}$	Turn-off input voltage	Decreasing input voltage	29	31	33	V
$V_{lon}$	Turn-on input voltage	Increasing input voltage	30	33	36	V
$C_I$	Internal input capacitance			1		$\mu\text{F}$
$P_O$	Output power		0		72	W
$\eta$	Efficiency	50 % of max $I_O$		87.5		%
		max $I_O$		86		
		50 % of max $I_O$ , $V_I = 48$ V		88		
		max $I_O$ , $V_I = 48$ V		86		
$P_d$	Power Dissipation	max $I_O$		12.2	15.9	W
$P_{ii}$	Input idling power	$I_O = 0$ A, $V_I = 53$ V		2.5		W
$P_{RC}$	Input standby power	$V_I = 53$ V (turned off with RC)		74		mW
$f_s$	Switching frequency	0-100 % of max $I_O$		250		kHz

$V_{Oi}$	Output voltage initial setting and accuracy	$T_{ref} = +25^{\circ}\text{C}$ , $V_I = 53$ V, $I_O = 60$ A	1.176	1.2	1.224	V
$V_O$	Output adjust range	See operating information	0.96		1.32	V
	Output voltage tolerance band	10-100% of max $I_O$	1.17		1.23	V
	Idling voltage	$I_O = 0$ A	1.17		1.23	V
	Line regulation	max $I_O$		0	5	mV
	Load regulation	$V_I = 53$ V, 1-100% of max $I_O$		0	5	mV
$V_{tr}$	Load transient voltage deviation	$V_I = 53$ V, Load step 25-75-25 % of max $I_O$ , $di/dt = 1$ A/ $\mu\text{s}$ , see Note 1		$\pm 200$		mV
$t_{tr}$	Load transient recovery time			50		$\mu\text{s}$
$t_r$	Ramp-up time (from 10-90 % of $V_{Oj}$ )	10-100% of max $I_O$ , $T_{ref} = 25^{\circ}\text{C}$ , $V_I = 53$ V		8	11	ms
$t_s$	Start-up time (from $V_I$ connection to 90% of $V_{Oj}$ )			13	18	ms
$t_f$	$V_{in}$ shutdown fall time (from $V_I$ off to 10% of $V_O$ )	max $I_O$		0.1		ms
		$I_O = 0$ A		13		s
$t_{RC}$	RC start-up time	max $I_O$		11		ms
	RC shutdown fall time (from RC off to 10% of $V_O$ )	max $I_O$		0.2		ms
		$I_O = 0$ A		8		s
$I_O$	Output current		0		60	A
$I_{lim}$	Current limit threshold	$V_O = 1.1$ V, $T_{ref} < \max T_{ref}$	61	65	81	A
$I_{sc}$	Short circuit current	$T_{ref} = 25^{\circ}\text{C}$ , $V_O < 0.2$ V, see Note 2		75		A
$V_{Oac}$	Output ripple & noise	See ripple & noise section, max $I_O$ , $V_{Oj}$		40	120	mVp-p
OVP	Over voltage protection	$T_{ref} = +25^{\circ}\text{C}$ , $V_I = 53$ V, 10-100% of max $I_O$		1.56		V

Note 1: Output filter according to Ripple & Noise section.

Note 2: RMS current in hiccup mode.

PKB4000C PI  
DC/DC converters, Input 36-75 V, Output 60A/144W

EN/LZT 146 377 R3G Oct 2008

© Ericsson Power Modules AB

1.2 V/60 A Typical Characteristics

PKB 4718LC PI

Efficiency

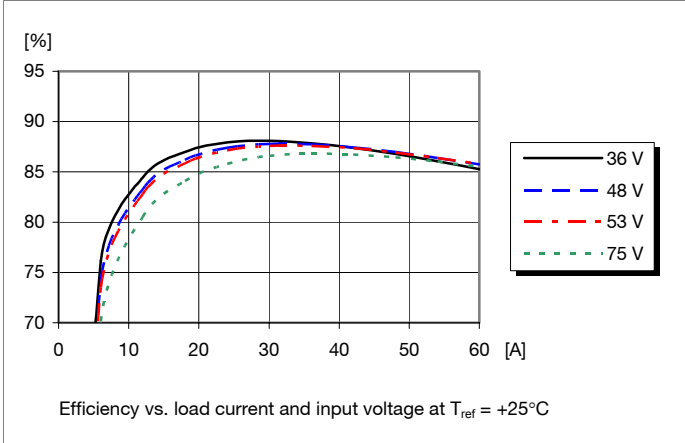

Power Dissipation

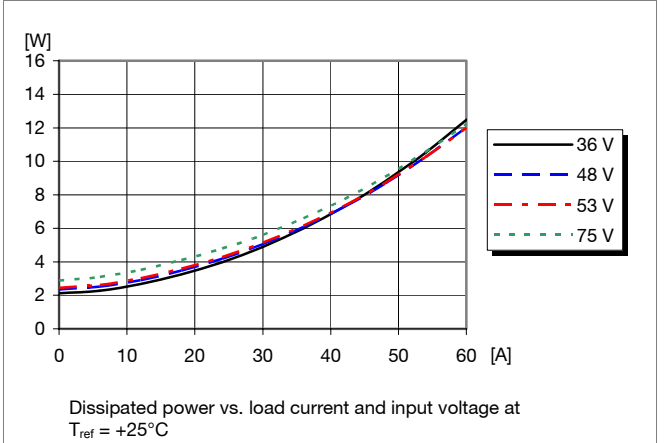

Output Characteristics

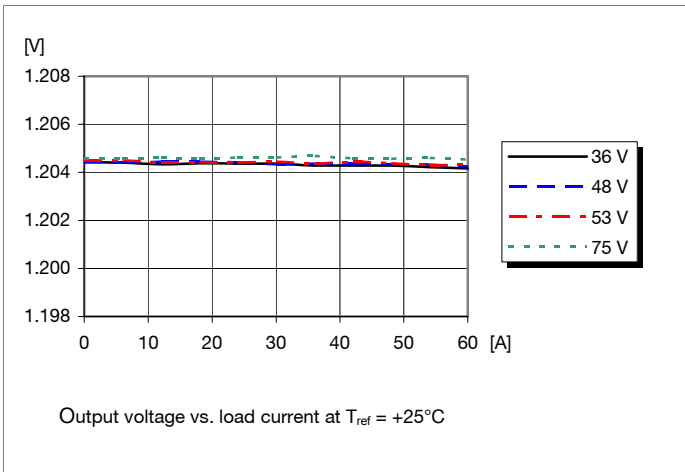

Current Limit Characteristics

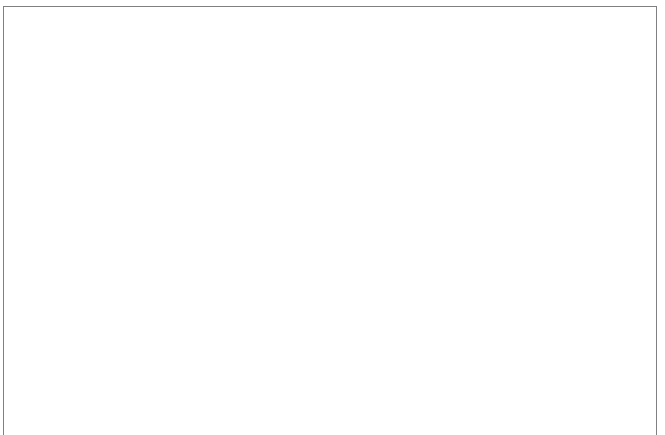
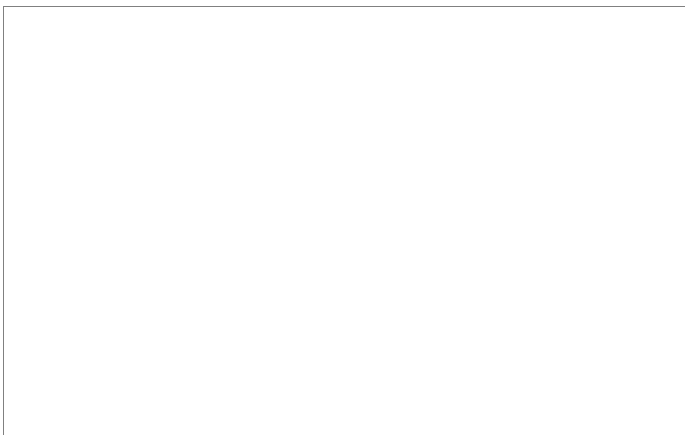
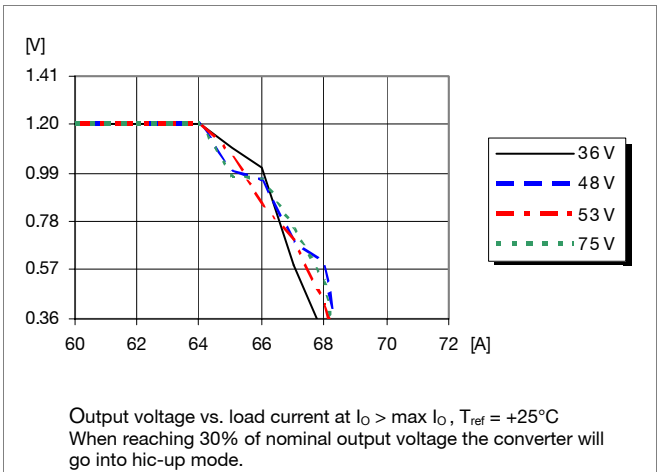

PKB4000C PI  
DC/DC converters, Input 36-75 V, Output 60A/144W

EN/LZT 146 377 R3G Oct 2008  
© Ericsson Power Modules AB

**1.2 V/60 A Typical Characteristics**

**PKB 4718LC PI**

**Start-up**

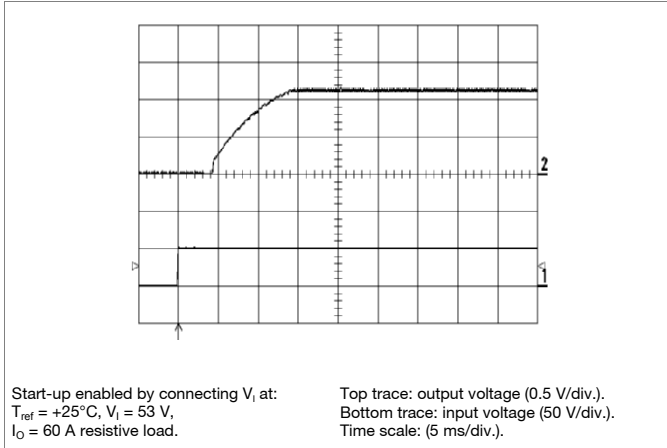

**Shut-down**

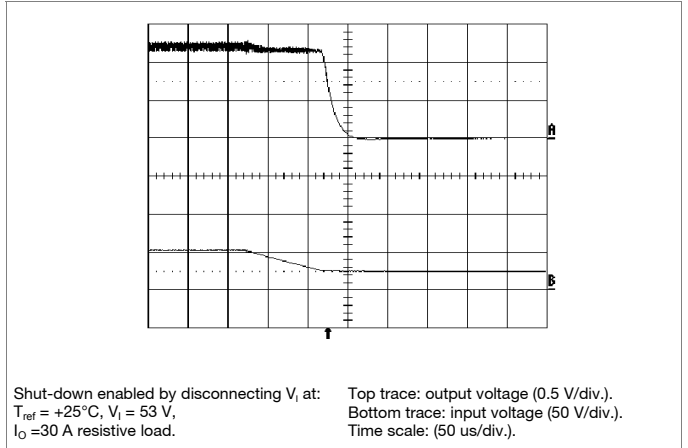

**Output Ripple & Noise**

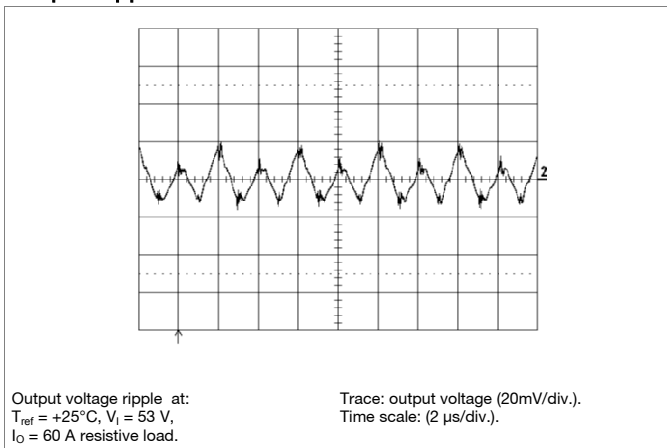

**Output Load Transient Response**

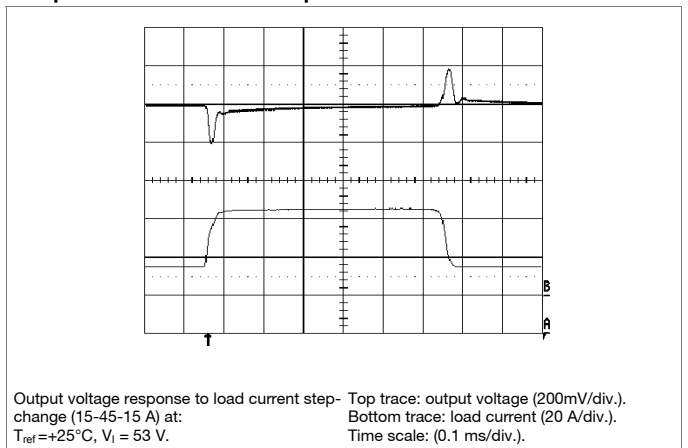

**Output Voltage Adjust (see operating information)**

**Passive adjust**

The resistor value for an adjusted output voltage is calculated by using the following equations:

Output Voltage Adjust Upwards, Increase:

$$R_{adj} = 5.11 \times \left( \frac{1.2 \times (100 + \Delta\%) - (100 + 2 \times \Delta\%)}{0.62 \times \Delta\%} \right) \text{ k}\Omega$$

Example: Increase 4% => V<sub>out</sub> = 1.248 Vdc

$$5.11 \times \left( \frac{1.2 \times (100 + 4) - (100 + 2 \times 4)}{0.62 \times 4} \right) \text{ k}\Omega = 119 \text{ k}\Omega$$

Output Voltage Adjust Downwards, Decrease:

$$R_{adj} = 5.11 \times \left( \frac{100}{\Delta\%} - 2 \right) \text{ k}\Omega$$

Example: Decrease 2% => V<sub>out</sub> = 1.176 Vdc

$$5.11 \times \left( \frac{100}{2} - 2 \right) \text{ k}\Omega = 245 \text{ k}\Omega$$

PKB4000C PI  
DC/DC converters, Input 36-75 V, Output 60A/144W

EN/LZT 146 377 R3G Oct 2008

© Ericsson Power Modules AB

**1.2 V/60 A Typical Characteristics**

**PKB 4718LC PI**

**Output Current Derating – Open frame**

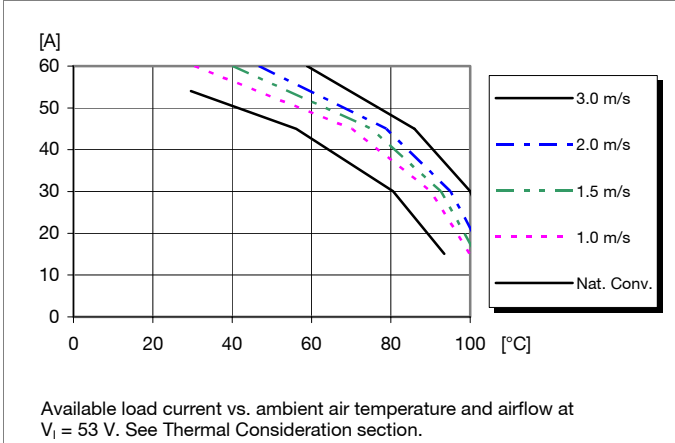

**Output Current Derating – Base Plate**

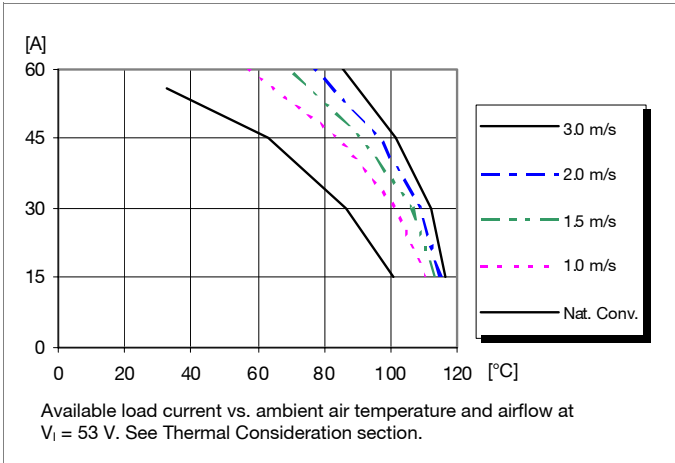

**Thermal Resistance – Base plate**

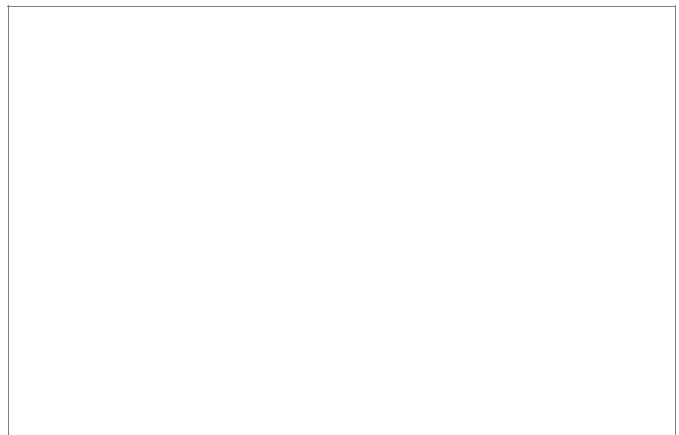
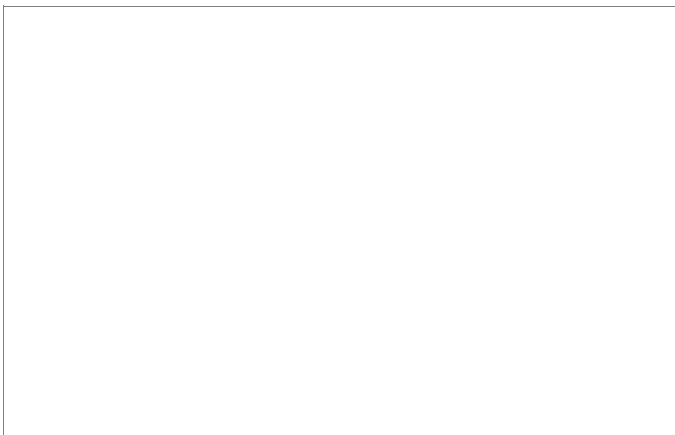
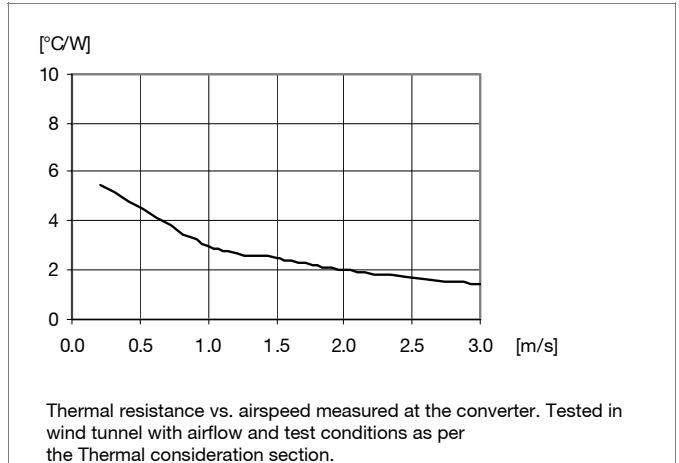



PKB4000C PI DC/DC converters, Input 36-75 V, Output 60A/144W	EN/LZT 146 377 R3G Oct 2008
	© Ericsson Power Modules AB

**1.5 V/60 A Electrical Specification**
**PKB 4918HC PI**

$T_{ref} = -40$  to  $+90^{\circ}\text{C}$ ,  $V_I = 36$  to  $75$  V, sense pins connected to output pins unless otherwise specified under Conditions.  
 Typical values given at:  $T_{ref} = +25^{\circ}\text{C}$ ,  $V_I = 53$  V, max  $I_O$ , unless otherwise specified under Conditions.

Characteristics		Conditions	min	typ	max	Unit
$V_I$	Input voltage range		36		75	V
$V_{loff}$	Turn-off input voltage	Decreasing input voltage	29	32	35	V
$V_{lon}$	Turn-on input voltage	Increasing input voltage	30	33	36	V
$C_I$	Internal input capacitance			1		$\mu\text{F}$
$P_O$	Output power		0		90	W
$\eta$	Efficiency	50 % of max $I_O$		88		%
		max $I_O$		87		
		50 % of max $I_O$ , $V_I = 48$ V		88.5		
		max $I_O$ , $V_I = 48$ V		87		
$P_d$	Power Dissipation	max $I_O$		14.1	15.9	W
$P_{li}$	Input idling power	$I_O = 0$ A, $V_I = 53$ V		3.2		W
$P_{RC}$	Input standby power	$V_I = 53$ V (turned off with RC)		99		mW
$f_s$	Switching frequency	0-100 % of max $I_O$		250		kHz

$V_{Oi}$	Output voltage initial setting and accuracy	$T_{ref} = +25^{\circ}\text{C}$ , $V_I = 53$ V, $I_O = 60$ A	1.47	1.5	1.53	V
$V_O$	Output adjust range	See operating information	1.20		1.65	V
	Output voltage tolerance band	10-100% of max $I_O$	1.47		1.53	V
	Idling voltage	$I_O = 0$ A	1.47		1.53	V
	Line regulation	max $I_O$		1	5	mV
	Load regulation	$V_I = 53$ V, 1-100% of max $I_O$		10	15	mV
$V_{tr}$	Load transient voltage deviation	$V_I = 53$ V, Load step 25-75-25 % of max $I_O$ , $di/dt = 1$ A/ $\mu\text{s}$ , see Note 1		$\pm 180$		mV
$t_{tr}$	Load transient recovery time			110		$\mu\text{s}$
$t_r$	Ramp-up time (from 10-90 % of $V_{Oi}$ )	10-100% of max $I_O$ , $T_{ref} = 25^{\circ}\text{C}$ , $V_I = 53$ V		8	11	ms
$t_s$	Start-up time (from $V_I$ connection to 90% of $V_{Oi}$ )			13	18	ms
$t_f$	$V_{in}$ shutdown fall time (from $V_{I,off}$ to 10% of $V_O$ )	max $I_O$		21		$\mu\text{s}$
		$I_O = 0.2$ A		48		ms
$t_{RC}$	RC start-up time	max $I_O$		12		ms
	RC shutdown fall time (from RC off to 10% of $V_O$ )	max $I_O$		10		$\mu\text{s}$
		$I_O = 0.2$ A		48		ms
$I_O$	Output current		0		60	A
$I_{lim}$	Current limit threshold	$V_O = 1.4$ V, $T_{ref} < \max T_{ref}$	64	66	68	A
$I_{sc}$	Short circuit current	$T_{ref} = 25^{\circ}\text{C}$ , $V_O < 0.2$ V, see Note 2		70		A
$V_{Oac}$	Output ripple & noise	See ripple & noise section, max $I_O$ , $V_{Oi}$		40	120	mVp-p
OVP	Over voltage protection	$T_{ref} = +25^{\circ}\text{C}$ , $V_I = 53$ V, 10-100% of max $I_O$		1.95		V

Note 1: Output filter according to Ripple & Noise section.

Note 2: RMS current in hiccup mode.

PKB4000C PI  
DC/DC converters, Input 36-75 V, Output 60A/144W

EN/LZT 146 377 R3G Oct 2008  
© Ericsson Power Modules AB

**1.5 V/60 A Typical Characteristics**

**PKB 4918HC PI**

**Efficiency**

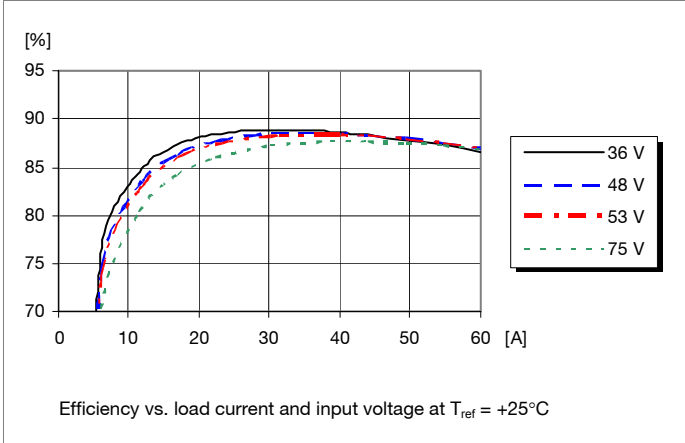

**Power Dissipation**

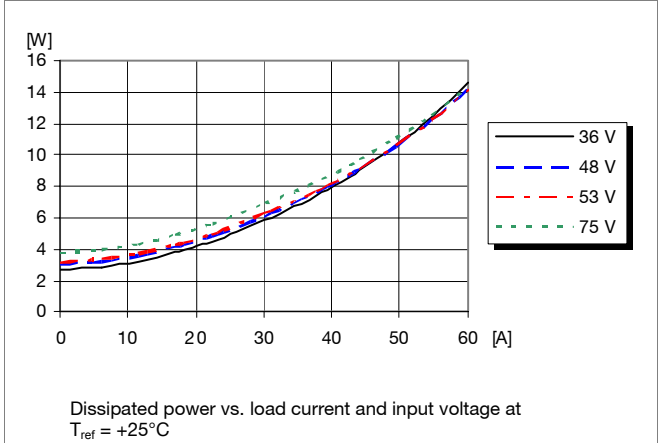

**Output Characteristics**

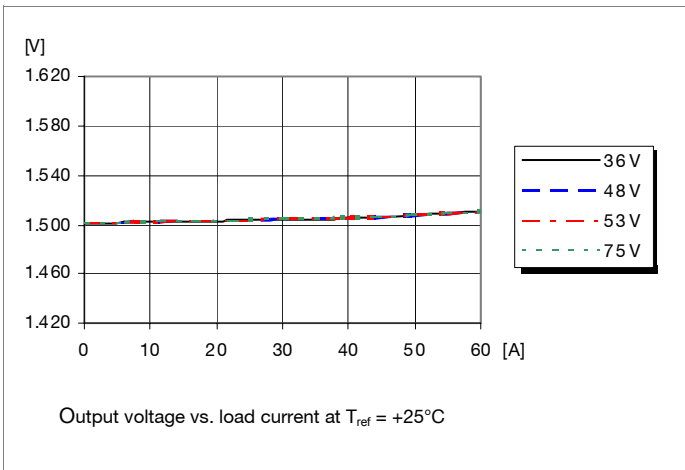

**Current Limit Characteristics**

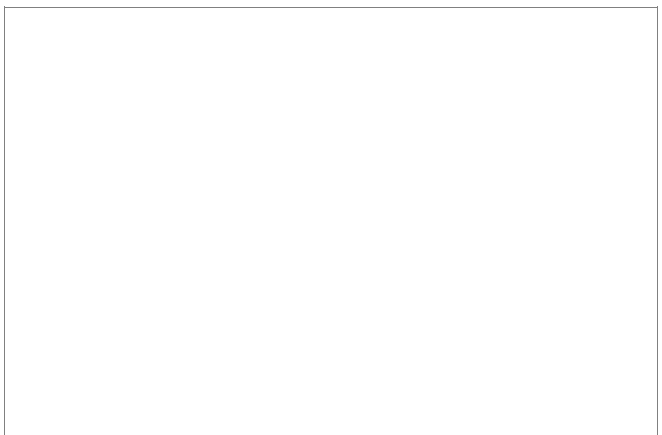
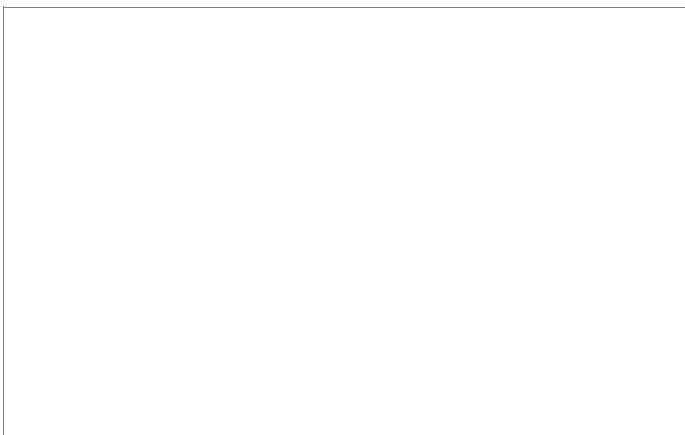
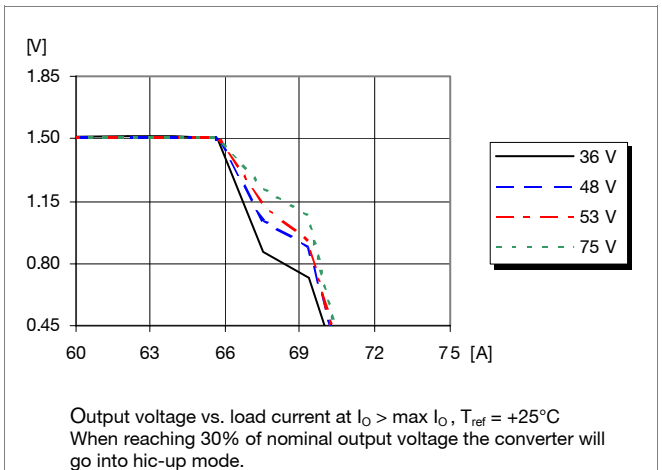

PKB4000C PI  
DC/DC converters, Input 36-75 V, Output 60A/144W

EN/LZT 146 377 R3G Oct 2008

© Ericsson Power Modules AB

**1.5 V/60 A Typical Characteristics**

**PKB 4918HC PI**

**Start-up**

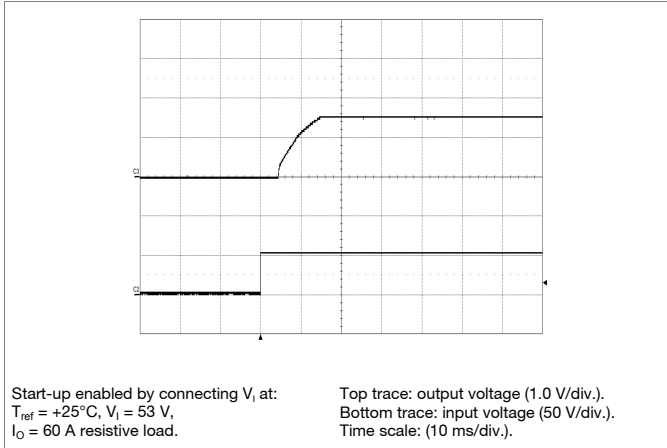

**Shut-down**

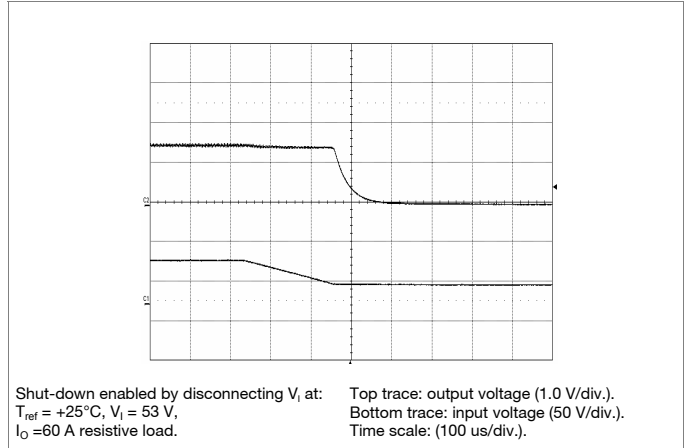

**Output Ripple & Noise**

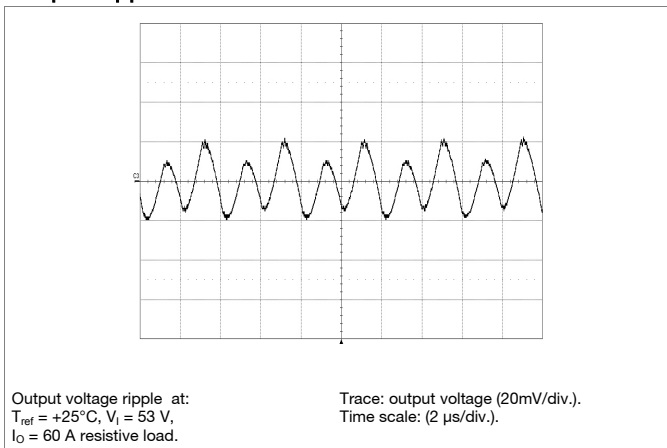

**Output Load Transient Response**

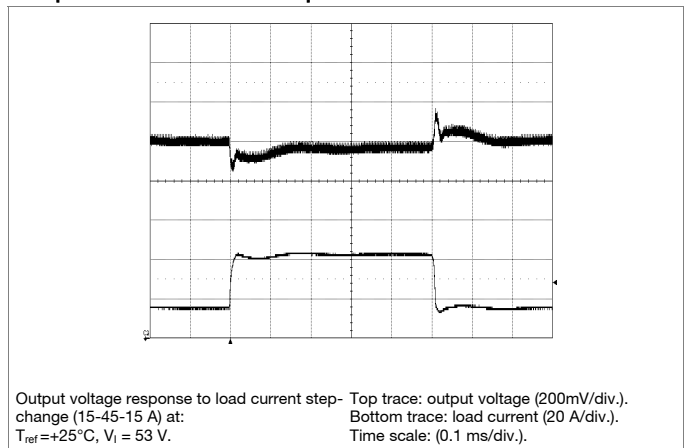

**Output Voltage Adjust (see operating information)**

**Passive adjust**

The resistor value for an adjusted output voltage is calculated by using the following equations:

Output Voltage Adjust Upwards, Increase:

$$R_{adj} = 5.11 \times \left( \frac{1.5 \times (100 + \Delta\%) - (100 + 2 \times \Delta\%)}{0.62 \times \Delta\%} - 2 \right) \text{ k}\Omega$$

Example: Increase 4%  $\Rightarrow V_{out} = 1.56\text{ Vdc}$

$$5.11 \times \left( \frac{1.5 \times (100 + 4) - (100 + 2 \times 4)}{0.62 \times 4} - 2 \right) \text{ k}\Omega = 183 \text{ k}\Omega$$

Output Voltage Adjust Downwards, Decrease:

$$R_{adj} = 5.11 \times \left( \frac{100}{\Delta\%} - 2 \right) \text{ k}\Omega$$

Example: Decrease 2%  $\Rightarrow V_{out} = 1.47\text{ Vdc}$

$$5.11 \times \left( \frac{100}{2} - 2 \right) \text{ k}\Omega = 245 \text{ k}\Omega$$

PKB4000C PI  
DC/DC converters, Input 36-75 V, Output 60A/144W

EN/LZT 146 377 R3G Oct 2008

© Ericsson Power Modules AB

**1.5 V/60 A Typical Characteristics**

**PKB 4918HC PI**

**Output Current Derating – Open frame**

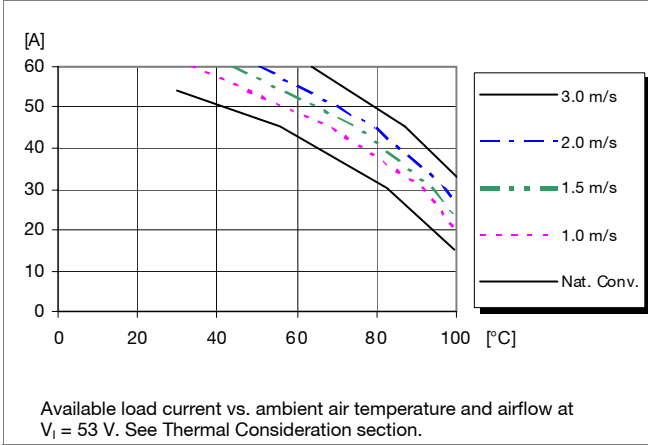

**Output Current Derating – Base plate**

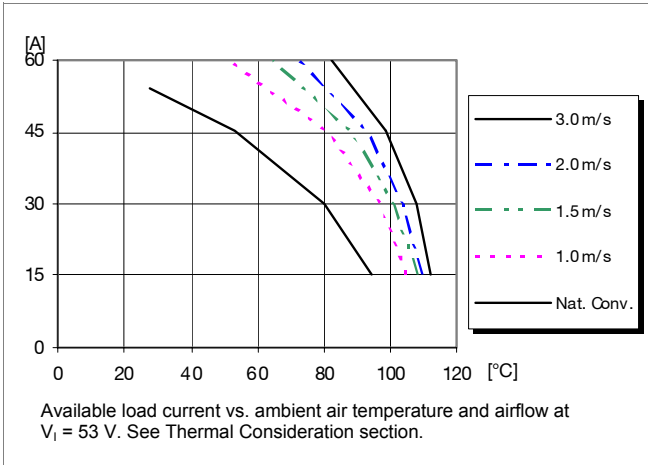

**Thermal Resistance – Base plate**

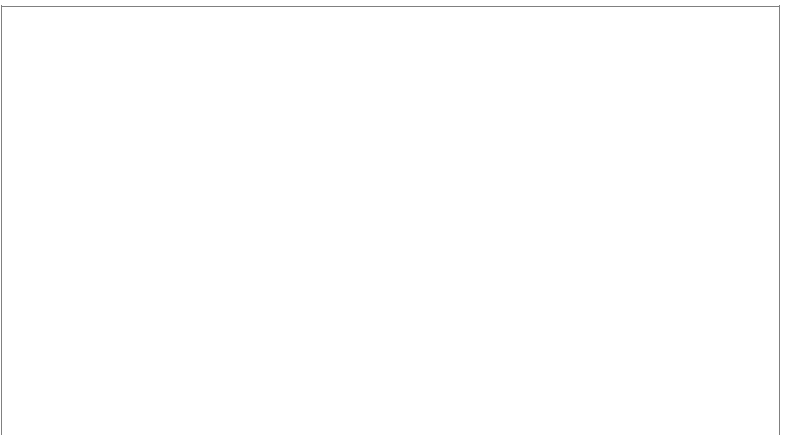
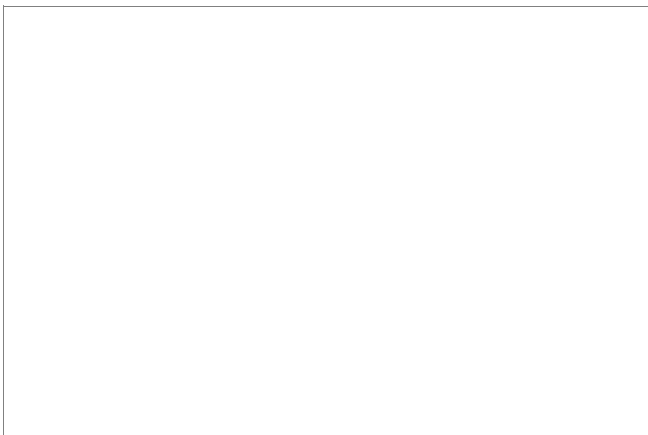
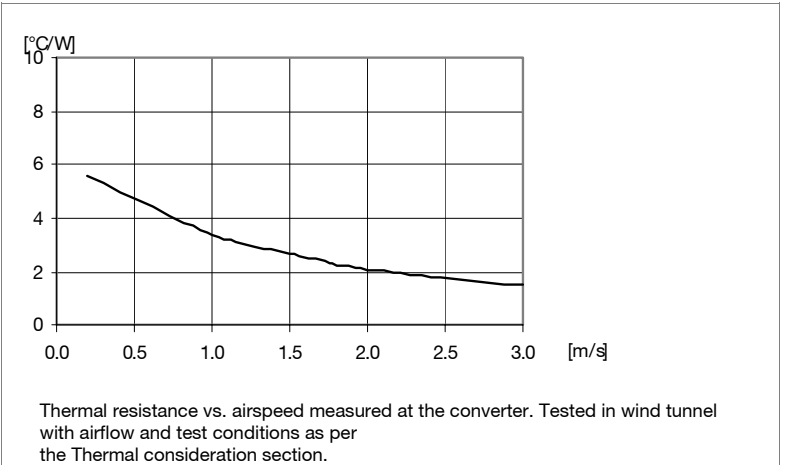

PKB4000C PI DC/DC converters, Input 36-75 V, Output 60A/144W	EN/LZT 146 377 R3G Oct 2008
	© Ericsson Power Modules AB

**1.8 V/60 A Electrical Specification**
**PKB 4118GC PI**
 $T_{ref} = -40$  to  $+90^{\circ}\text{C}$ ,  $V_I = 36$  to  $75$  V, sense pins connected to output pins unless otherwise specified under Conditions.

 Typical values given at:  $T_{ref} = +25^{\circ}\text{C}$ ,  $V_I = 53$  V, max  $I_O$ , unless otherwise specified under Conditions.

Characteristics		Conditions	min	typ	max	Unit
$V_I$	Input voltage range		36		75	V
$V_{loff}$	Turn-off input voltage	Decreasing input voltage	29	32	35	V
$V_{lon}$	Turn-on input voltage	Increasing input voltage	30	33	36	V
$C_I$	Internal input capacitance			1		$\mu\text{F}$
$P_O$	Output power		0		108	W
$\eta$	Efficiency	50 % of max $I_O$		89		%
		max $I_O$		88		
		50 % of max $I_O$ , $V_I = 48$ V		89.5		
		max $I_O$ , $V_I = 48$ V		88		
$P_d$	Power Dissipation	max $I_O$		14.7	16.8	W
$P_{li}$	Input idling power	$I_O = 0$ A, $V_I = 53$ V		3.5		W
$P_{RC}$	Input standby power	$V_I = 53$ V (turned off with RC)		82		mW
$f_s$	Switching frequency	0-100 % of max $I_O$		250		kHz

$V_{Oi}$	Output voltage initial setting and accuracy	$T_{ref} = +25^{\circ}\text{C}$ , $V_I = 53$ V, $I_O = 60$ A	1.76	1.8	1.84	V
$V_O$	Output adjust range	See operating information	1.44		1.98	V
	Output voltage tolerance band	10-100% of max $I_O$	1.76		1.84	V
	Idling voltage	$I_O = 0$ A	1.76		1.84	V
	Line regulation	max $I_O$		1	5	mV
	Load regulation	$V_I = 53$ V, 1-100% of max $I_O$		10	15	mV
$V_{tr}$	Load transient voltage deviation	$V_I = 53$ V, Load step 25-75-25 % of max $I_O$ , $di/dt = 1$ A/ $\mu\text{s}$ , see Note 1		$\pm 180$		mV
$t_{tr}$	Load transient recovery time			120		$\mu\text{s}$
$t_r$	Ramp-up time (from 10-90 % of $V_{Oi}$ )	10-100% of max $I_O$ , $T_{ref} = 25^{\circ}\text{C}$ , $V_I = 53$ V		8	11	ms
$t_s$	Start-up time (from $V_I$ connection to 90% of $V_{Oi}$ )			13	18	ms
$t_f$	$V_{in}$ shutdown fall time (from $V_{Ioff}$ to 10% of $V_O$ )	max $I_O$		35		$\mu\text{s}$
		$I_O = 0.2$ A		9		ms
$t_{RC}$	RC start-up time	max $I_O$		11		ms
	RC shutdown fall time (from RC off to 10% of $V_O$ )	max $I_O$		35		$\mu\text{s}$
		$I_O = 0.2$ A		9		ms
$I_O$	Output current		0		60	A
$I_{lim}$	Current limit threshold	$V_O = 1.7\text{V}$ , $T_{ref} < \max T_{ref}$	64	66	68	A
$I_{sc}$	Short circuit current	$T_{ref} = 25^{\circ}\text{C}$ , $V_O < 0.2\text{V}$ , see Note 2		72		A
$V_{Oac}$	Output ripple & noise	See ripple & noise section, max $I_O$ , $V_{Oi}$		40	120	mVp-p
OVP	Over voltage protection	$T_{ref} = +25^{\circ}\text{C}$ , $V_I = 53$ V, 10-100% of max $I_O$		2.34		V

Note 1: Output filter according to Ripple &amp; Noise section.

Note 2: RMS current in hiccup mode.

PKB4000C PI  
DC/DC converters, Input 36-75 V, Output 60A/144W

EN/LZT 146 377 R3G Oct 2008  
© Ericsson Power Modules AB

**1.8 V/60 A Typical Characteristics**

**PKB 4118GC PI**

**Efficiency**

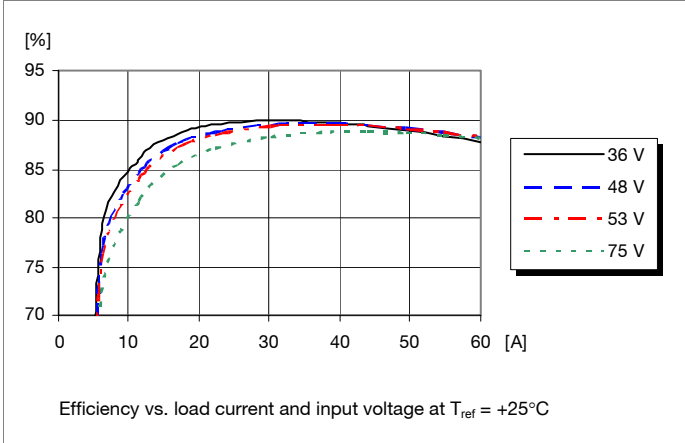

**Power Dissipation**

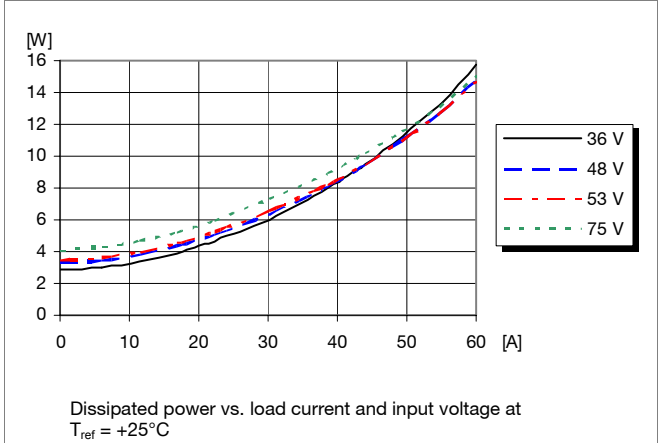

**Output Characteristics**

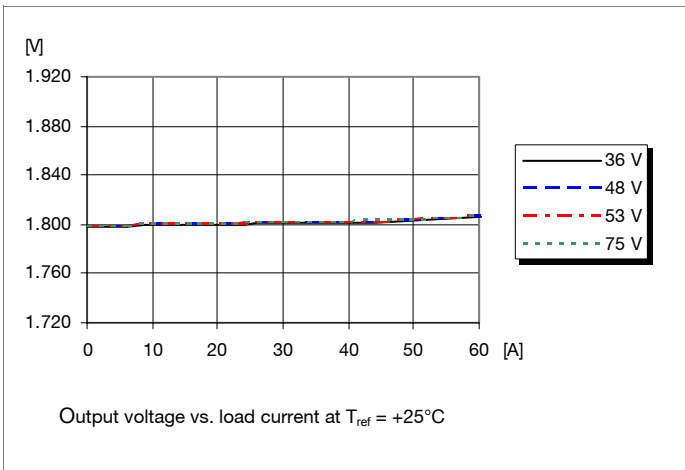

**Current Limit Characteristics**

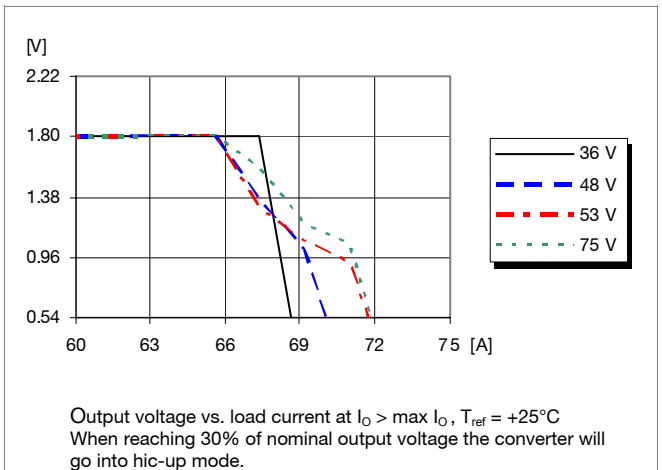

PKB4000C PI  
DC/DC converters, Input 36-75 V, Output 60A/144W

EN/LZT 146 377 R3G Oct 2008

© Ericsson Power Modules AB

**Start-up**

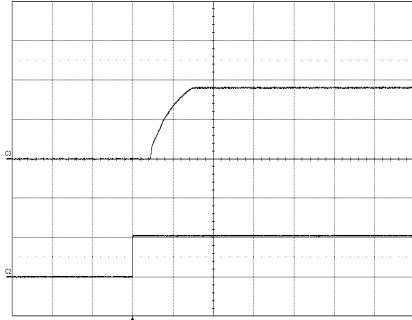

Start-up enabled by connecting  $V_i$  at:  
 $T_{ref} = +25^{\circ}\text{C}$ ,  $V_i = 53\text{ V}$ ,  
 $I_o = 60\text{ A}$  resistive load.  
Top trace: output voltage (1.0 V/div).  
Bottom trace: input voltage (50 V/div).  
Time scale: (10 ms/div.).

**Shut-down**

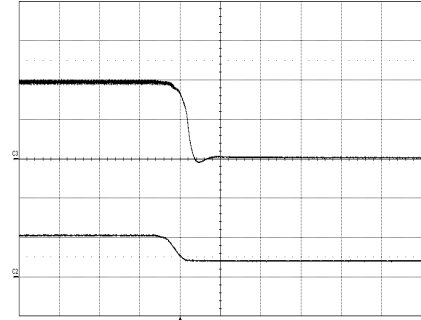

Shut-down enabled by disconnecting  $V_i$  at:  
 $T_{ref} = +25^{\circ}\text{C}$ ,  $V_i = 53\text{ V}$ ,  
 $I_o = 60\text{ A}$  resistive load.  
Top trace: output voltage (1.0 V/div).  
Bottom trace: input voltage (50 V/div).  
Time scale: (100 us/div.).

**Output Ripple & Noise**

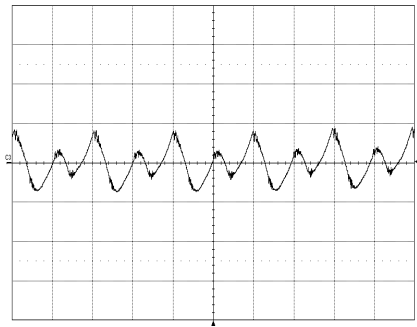

Output voltage ripple at:  
 $T_{ref} = +25^{\circ}\text{C}$ ,  $V_i = 53\text{ V}$ ,  
 $I_o = 60\text{ A}$  resistive load.  
Trace: output voltage (20mV/div.).  
Time scale: (2 us/div.).

**Output Load Transient Response**

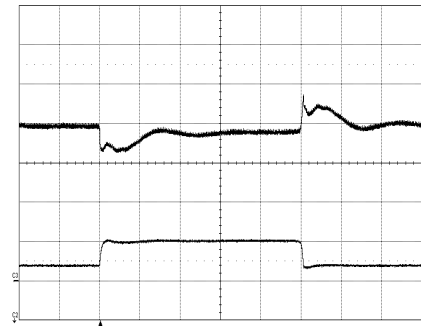

Output voltage response to load current step- change (15-45-15 A) at:  
 $T_{ref} = +25^{\circ}\text{C}$ ,  $V_i = 53\text{ V}$ .  
Top trace: output voltage (200mV/div.).  
Bottom trace: load current (50 A/div.).  
Time scale: (0.1 ms/div.).

**Output Voltage Adjust (see operating information)**

**Passive adjust**

The resistor value for an adjusted output voltage is calculated by using the following equations:

Output Voltage Adjust Upwards, Increase:

$$R_{adj} = 5.11 \times \left( \frac{1.8 \times (100 + \Delta\%) - (100 + 2 \times \Delta\%)}{0.62 \times \Delta\%} \right) \text{ k}\Omega$$

Example: Increase 4%  $\Rightarrow V_{out} = 1.872\text{ Vdc}$

$$5.11 \times \left( \frac{1.8 \times (100 + 4) - (100 + 2 \times 4)}{0.62 \times 4} \right) \text{ k}\Omega = 248 \text{ k}\Omega$$

Output Voltage Adjust Downwards, Decrease:

$$R_{adj} = 5.11 \times \left( \frac{100}{\Delta\%} - 2 \right) \text{ k}\Omega$$

Example: Decrease 2%  $\Rightarrow V_{out} = 1.764\text{ Vdc}$

$$5.11 \times \left( \frac{100}{2} - 2 \right) \text{ k}\Omega = 245 \text{ k}\Omega$$

PKB4000C PI  
DC/DC converters, Input 36-75 V, Output 60A/144W

EN/LZT 146 377 R3G Oct 2008  
© Ericsson Power Modules AB

**1.8 V/60 A Typical Characteristics**

**PKB 4118GC PI**

**Output Current Derating – Open frame**

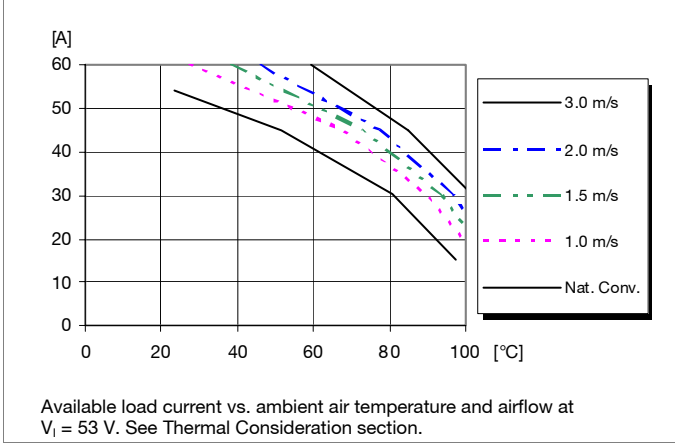

**Output Current Derating – Base plate**

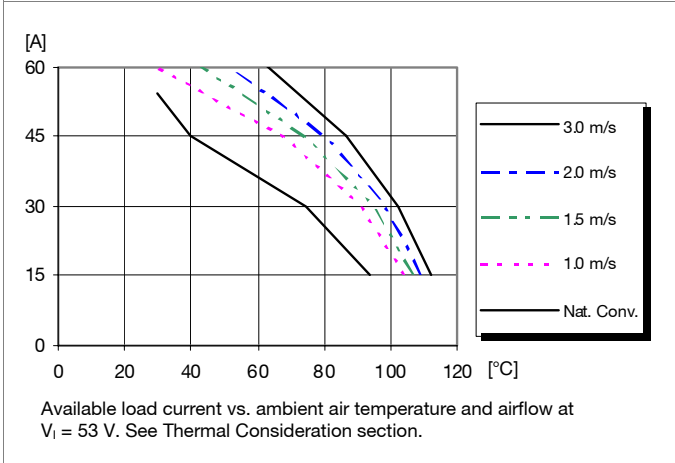

**Thermal Resistance – Base plate**

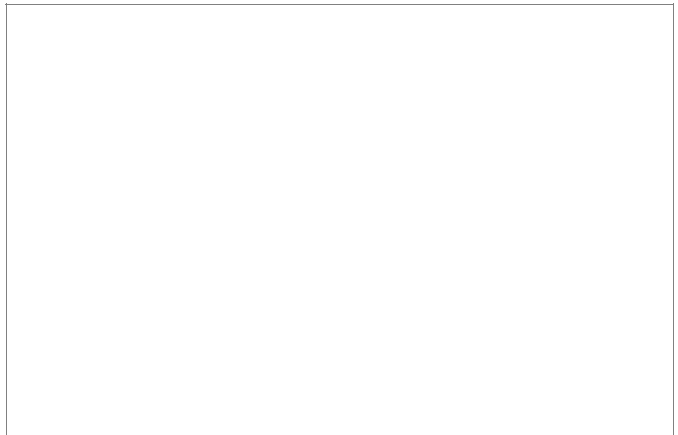
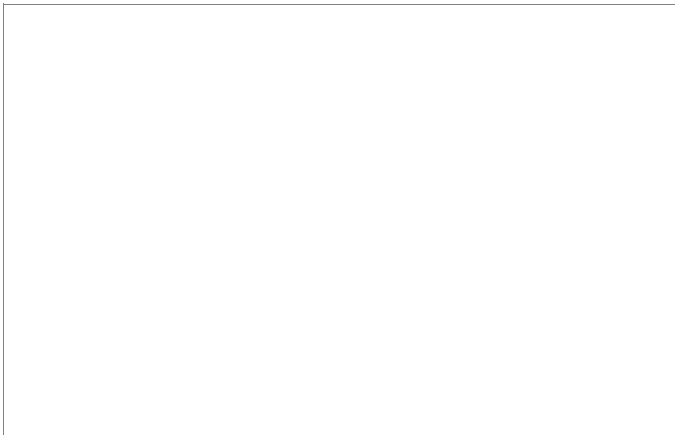
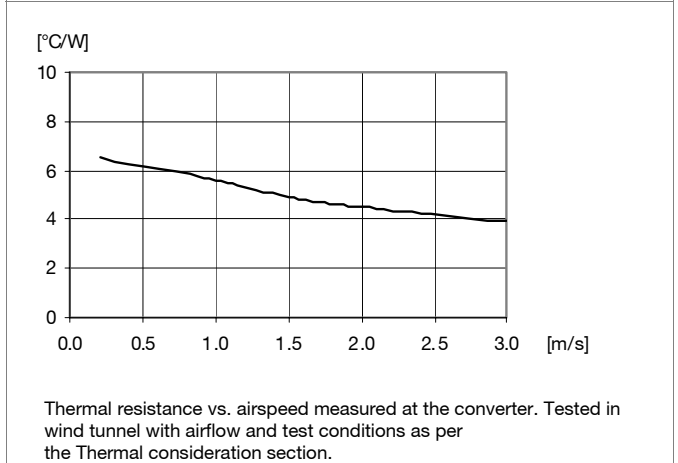



PKB4000C PI DC/DC converters, Input 36-75 V, Output 60A/144W	EN/LZT 146 377 R3G Oct 2008
	© Ericsson Power Modules AB

### 3.3 V/40 A Electrical Specification

### PKB 4110C PI

$T_{ref} = -40$  to  $+90^{\circ}\text{C}$ ,  $V_I = 36$  to  $75$  V, sense pins connected to output pins unless otherwise specified under Conditions.

Typical values given at:  $T_{ref} = +25^{\circ}\text{C}$ ,  $V_I = 53$  V, max  $I_O$ , unless otherwise specified under Conditions.

Characteristics		Conditions	min	typ	max	Unit
$V_I$	Input voltage range		36		75	V
$V_{loff}$	Turn-off input voltage	Decreasing input voltage	29	31	33	V
$V_{lon}$	Turn-on input voltage	Increasing input voltage	30	33	36	V
$C_I$	Internal input capacitance			1		$\mu\text{F}$
$P_O$	Output power		0		132	W
$\eta$	Efficiency	50 % of max $I_O$		91		%
		max $I_O$		91		
		50 % of max $I_O$ , $V_I = 48$ V		91		
		max $I_O$ , $V_I = 48$ V		91		
$P_d$	Power Dissipation	max $I_O$		13.1	16.7	W
$P_{ii}$	Input idling power	$I_O = 0$ A, $V_I = 53$ V		3.8		W
$P_{RC}$	Input standby power	$V_I = 53$ V (turned off with RC)		0.06		W
$f_s$	Switching frequency	0-100 % of max $I_O$		250		kHz

$V_{Oi}$	Output voltage initial setting and accuracy	$T_{ref} = +25^{\circ}\text{C}$ , $V_I = 53$ V, $I_O = 40$ A	3.23	3.29	3.35	V
$V_O$	Output adjust range	See operating information	2.64		3.63	V
	Output voltage tolerance band	10-100% of max $I_O$	3.22		3.36	V
	Idling voltage	$I_O = 0$ A	3.22		3.36	V
	Line regulation	max $I_O$		0	5	mV
	Load regulation	$V_I = 53$ V, 1-100% of max $I_O$		0	10	mV
$V_{tr}$	Load transient voltage deviation	$V_I = 53$ V, Load step 25-75-25 % of max $I_O$ , $di/dt = 1$ A/ $\mu\text{s}$ , see Note 2		$\pm 350$		mV
$t_{tr}$	Load transient recovery time			50		$\mu\text{s}$
$t_r$	Ramp-up time (from 10-90 % of $V_O$ )	10-100% of max $I_O$ , $T_{ref} = 25^{\circ}\text{C}$ , $V_I = 53$ V		6	10	ms
$t_s$	Start-up time (from $V_I$ connection to 90% of $V_O$ )	$T_{ref} = 25^{\circ}\text{C}$ , $V_I = 53$ V		12	15	ms
$t_f$	$V_{in}$ shutdown fall time (from $V_I$ off to 10% of $V_O$ )	max $I_O$		0.1		ms
		$I_O = 0$ A		8		s
$t_{RC}$	RC start-up time	max $I_O$		9		ms
	RC shutdown fall time (from RC off to 10% of $V_O$ )	max $I_O$		0.1		ms
		$I_O = 0$ A		8		s
$I_O$	Output current		0		40	A
$I_{lim}$	Current limit threshold	$V_O = 3.2$ V, $T_{ref} < \max T_{ref}$	41	46	53	A
$I_{sc}$	Short circuit current	$T_{ref} = 25^{\circ}\text{C}$ , $V_O < 0.5$ V, see Note 3		15		A
$V_{Oac}$	Output ripple & noise	See ripple & noise section, max $I_O$ , $V_{Oi}$		65	130	mVp-p
OVP	Over voltage protection	$T_{ref} = +25^{\circ}\text{C}$ , $V_I = 53$ V, 10-100% of max $I_O$		4.3		V

Note 2: Output filter according to Ripple & Noise section.

Note 3: RMS current in hiccup mode.

PKB4000C PI  
DC/DC converters, Input 36-75 V, Output 60A/144W

EN/LZT 146 377 R3G Oct 2008  
© Ericsson Power Modules AB

**3.3 V/40 A Typical Characteristics**

**PKB 4110C PI**

**Efficiency**

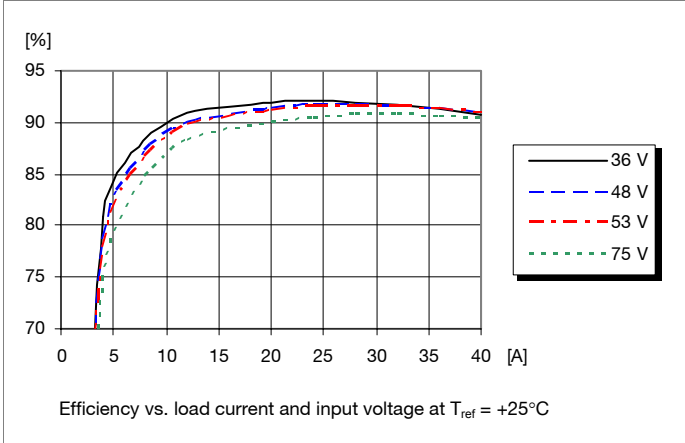

**Power Dissipation**

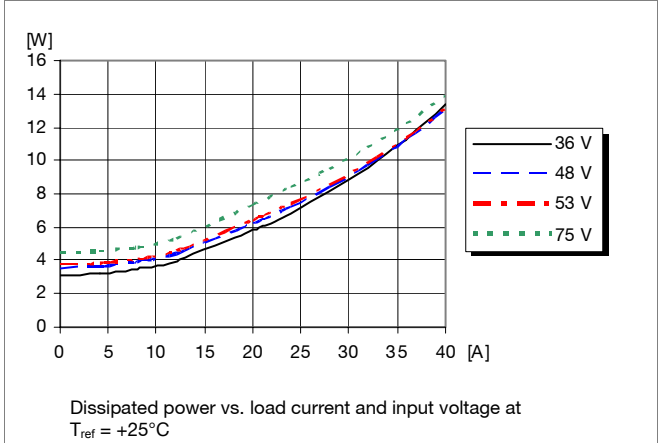

**Output Characteristics**

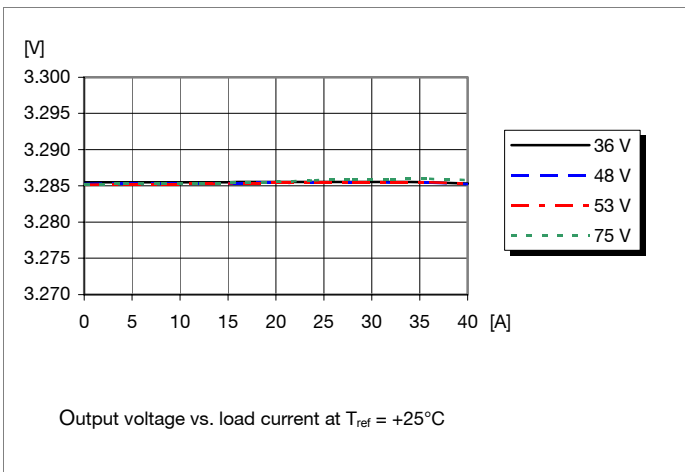

**Current Limit Characteristics**

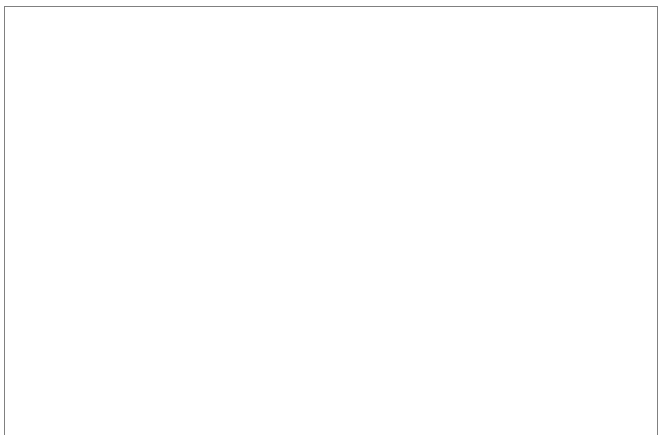
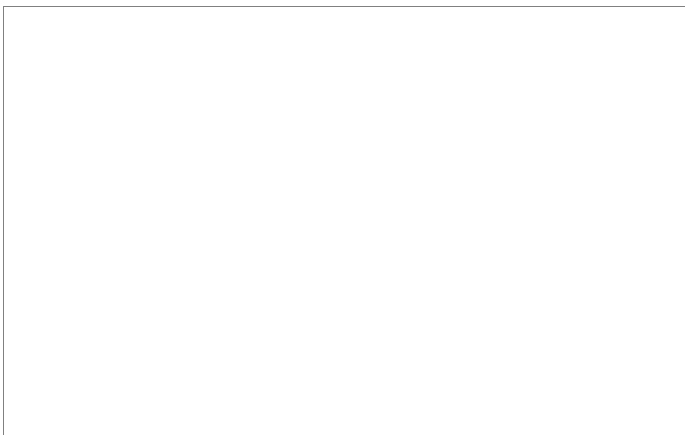
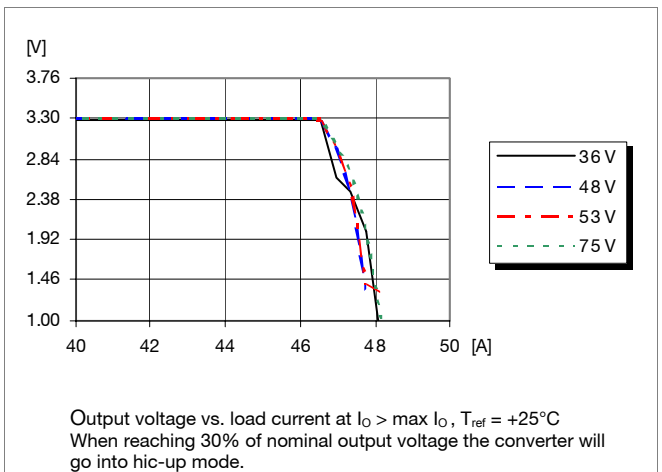

PKB4000C PI  
DC/DC converters, Input 36-75 V, Output 60A/144W

EN/LZT 146 377 R3G Oct 2008  
© Ericsson Power Modules AB

**3.3 V/40 A Typical Characteristics**

**PKB 4110C PI**

**Start-up**

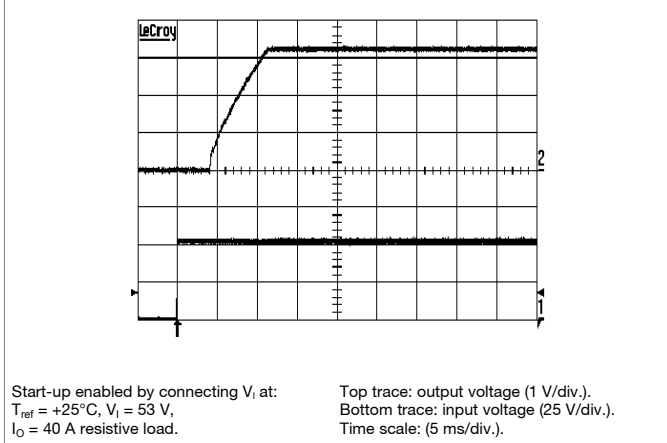

**Shut-down**

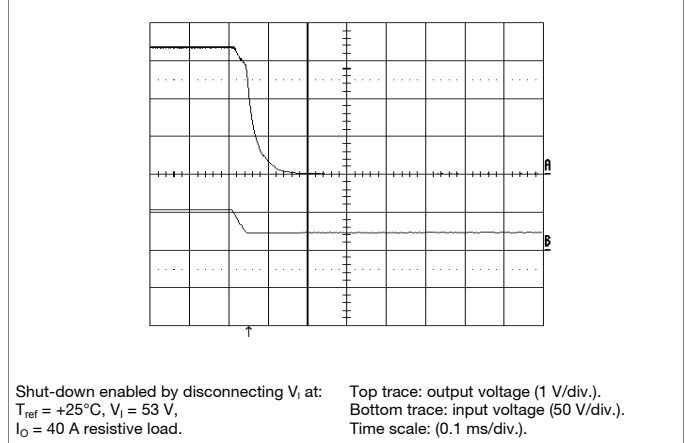

**Output Ripple & Noise**

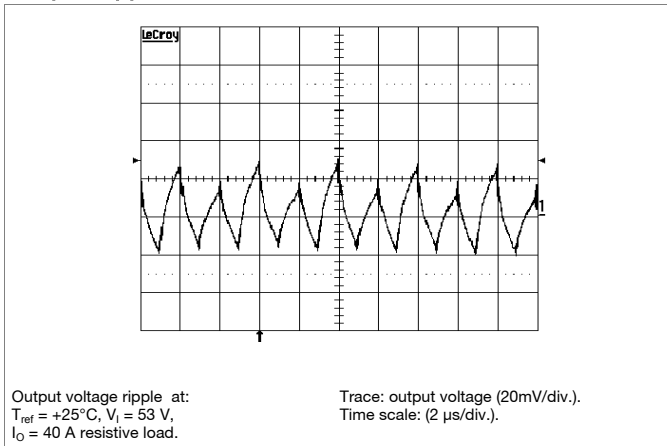

**Output Load Transient Response**

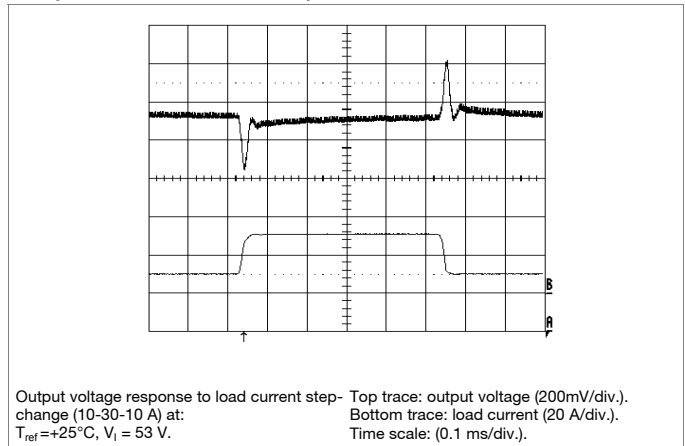

**Output Voltage Adjust (see operating information)**

**Passive adjust**

The resistor value for an adjusted output voltage is calculated by using the following equations:

Output Voltage Adjust Upwards, Increase:

$$R_{adj} = 5.11 \times \left( \frac{3.3(100 + \Delta\%)}{1.225 \times \Delta\%} - \frac{(100 + 2 \times \Delta\%)}{\Delta\%} \right) \text{ k}\Omega$$

Example: Increase 4%  $\Rightarrow V_{out} = 3.43\text{ Vdc}$

$$5.11 \times \left( \frac{3.3(100 + 4)}{1.225 \times 4} - \frac{(100 + 2 \times 4)}{4} \right) \text{ k}\Omega = 220 \text{ k}\Omega$$

Output Voltage Adjust Downwards, Decrease:

$$R_{adj} = 5.11 \times \left( \frac{100}{\Delta\%} - 2 \right) \text{ k}\Omega$$

Example: Decrease 2%  $\Rightarrow V_{out} = 3.23\text{ Vdc}$

$$5.11 \times \left( \frac{100}{2} - 2 \right) \text{ k}\Omega = 245 \text{ k}\Omega$$

PKB4000C PI  
DC/DC converters, Input 36-75 V, Output 60A/144W

EN/LZT 146 377 R3G Oct 2008  
© Ericsson Power Modules AB

**3.3 V/40 A Typical Characteristics**

**PKB 4110C PI**

**Output Current Derating – Open frame**

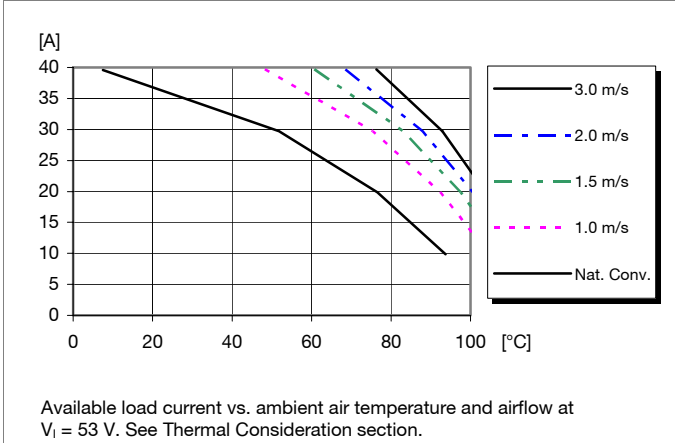

**Output Current Derating – Base plate**

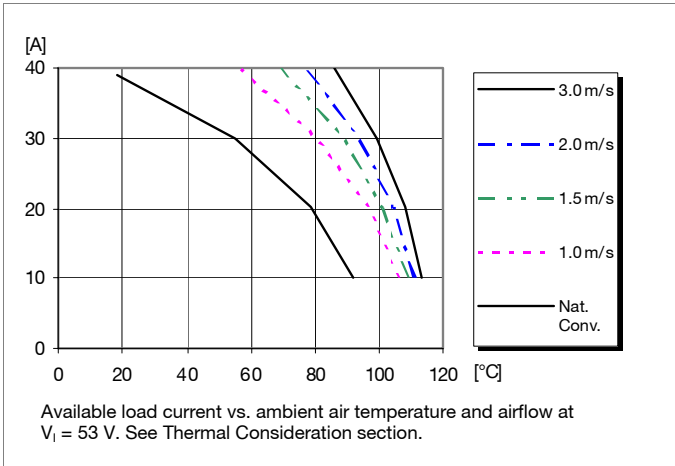

**Thermal Resistance – Base plate**

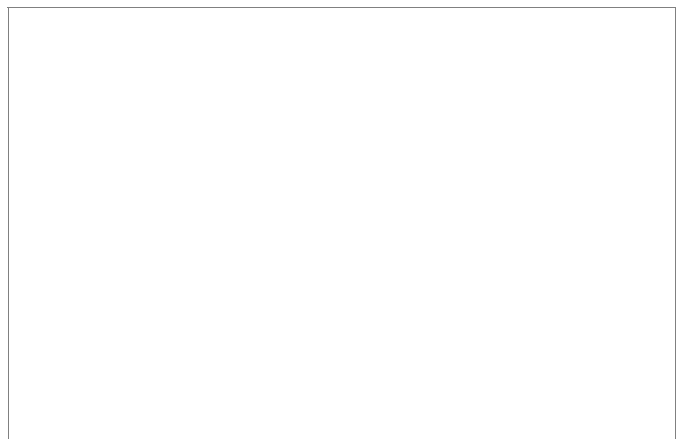
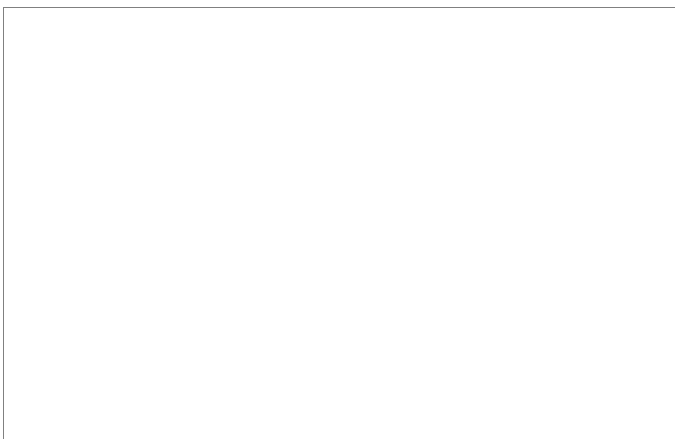
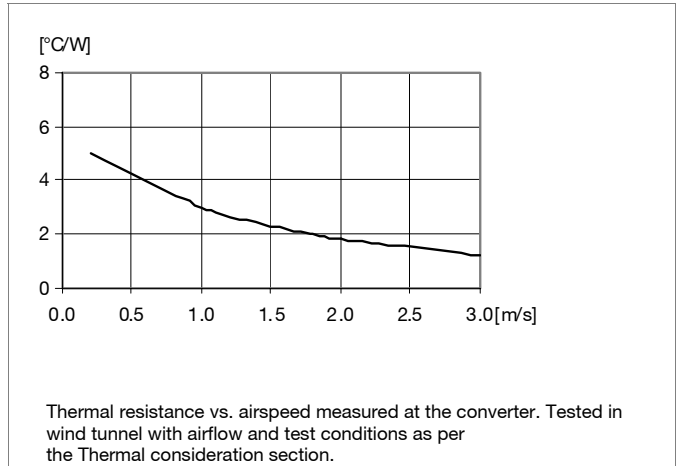

PKB4000C PI DC/DC converters, Input 36-75 V, Output 60A/144W	EN/LZT 146 377 R3G Oct 2008
	© Ericsson Power Modules AB

**5.0 V/28 A Electrical Specification**
**PKB 4111C PI**

$T_{ref} = -40$  to  $+90^{\circ}\text{C}$ ,  $V_I = 36$  to  $75$  V, sense pins connected to output pins unless otherwise specified under Conditions.

Typical values given at:  $T_{ref} = +25^{\circ}\text{C}$ ,  $V_I = 53$  V, max  $I_O$ , unless otherwise specified under Conditions.

Characteristics		Conditions	min	typ	max	Unit
$V_I$	Input voltage range		36		75	V
$V_{loff}$	Turn-off input voltage	Decreasing input voltage	29	31	33	V
$V_{lon}$	Turn-on input voltage	Increasing input voltage	30	33	36	V
$C_I$	Internal input capacitance			1		$\mu\text{F}$
$P_O$	Output power		0		140	W
$\eta$	Efficiency	50 % of max $I_O$		92		%
		max $I_O$		92		
		50 % of max $I_O$ , $V_I = 48$ V		92		
		max $I_O$ , $V_I = 48$ V		92		
$P_d$	Power Dissipation	max $I_O$		12.5	17	W
$P_{li}$	Input idling power	$I_O = 0$ A, $V_I = 53$ V		4		W
$P_{RC}$	Input standby power	$V_I = 53$ V (turned off with RC)		60		mW
$f_s$	Switching frequency	0-100 % of max $I_O$		250		kHz

$V_{Oi}$	Output voltage initial setting and accuracy	$T_{ref} = +25^{\circ}\text{C}$ , $V_I = 53$ V, $I_O = 28$ A	4.9	5	5.1	V
$V_O$	Output adjust range	See operating information	4		5.5	V
	Output voltage tolerance band	10-100% of max $I_O$	4.87		5.13	V
	Idling voltage	$I_O = 0$ A	4.87		5.13	V
	Line regulation	max $I_O$		0	8	mV
	Load regulation	$V_I = 53$ V, 1-100% of max $I_O$		0	10	mV
$V_{tr}$	Load transient voltage deviation	$V_I = 53$ V, Load step 25-75-25 % of max $I_O$ , $di/dt = 1$ A/ $\mu\text{s}$ , see Note 1		$\pm 350$		mV
$t_{tr}$	Load transient recovery time			50		$\mu\text{s}$
$t_r$	Ramp-up time (from 10-90 % of $V_{Oj}$ )	10-100% of max $I_O$ , $T_{ref} = 25^{\circ}\text{C}$ , $V_I = 53$ V		6	10	ms
$t_s$	Start-up time (from $V_I$ connection to 90% of $V_{Oj}$ )			12	15	ms
$t_f$	$V_{in}$ shutdown fall time (from $V_{I,off}$ to 10% of $V_O$ )	max $I_O$		0.2		ms
		$I_O = 0$ A		8		s
$t_{RC}$	RC start-up time	max $I_O$		9		ms
	RC shutdown fall time (from RC off to 10% of $V_O$ )	max $I_O$		0.2		ms
		$I_O = 0$ A		8		s
$I_O$	Output current		0		28	A
$I_{lim}$	Current limit threshold	$V_O = 3.2$ V, $T_{ref} < \max T_{ref}$	30	35	42	A
$I_{sc}$	Short circuit current	$T_{ref} = 25^{\circ}\text{C}$ , $V_O < 0.5$ V, see Note 2		10		A
$V_{Oac}$	Output ripple & noise	See ripple & noise section, max $I_O$ , $V_{Oj}$		60	150	mVp-p
OVP	Over voltage protection	$T_{ref} = +25^{\circ}\text{C}$ , $V_I = 53$ V, 10-100% of max $I_O$		6.5		V

Note 1: Output filter according to Ripple & Noise section.

Note 2: RMS current in hiccup mode.

PKB4000C PI  
DC/DC converters, Input 36-75 V, Output 60A/144W

EN/LZT 146 377 R3G Oct 2008  
© Ericsson Power Modules AB

**5.0 V/28 A Typical Characteristics**

**PKB 4111C PI**

**Efficiency**

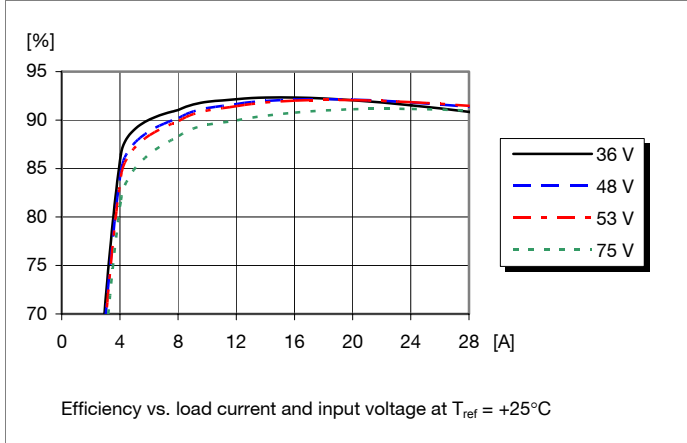

**Power Dissipation**

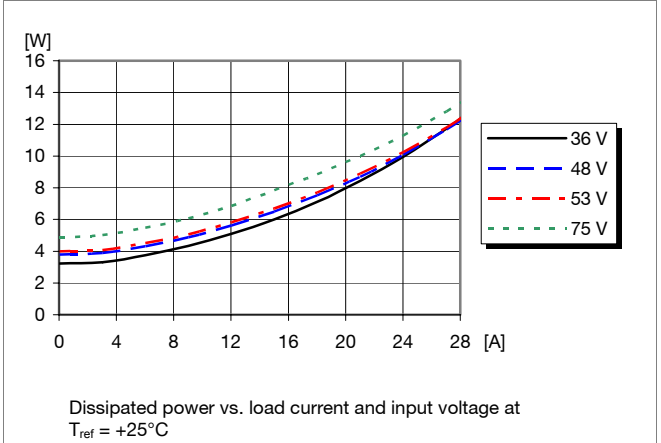

**Output Characteristics**

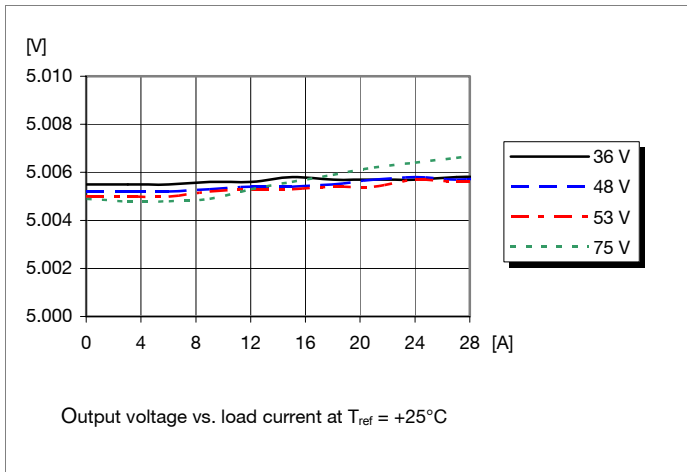

**Current Limit Characteristics**

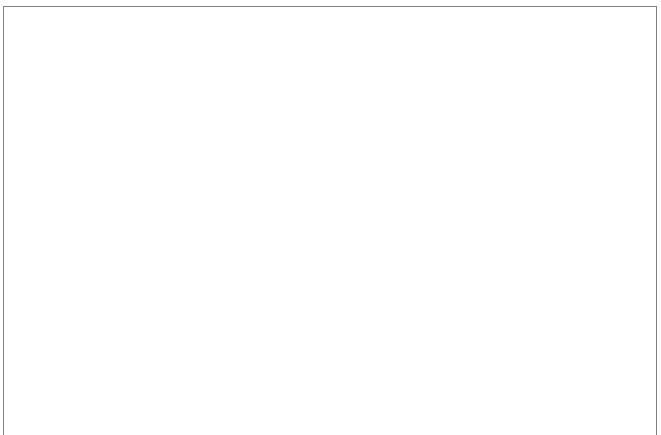
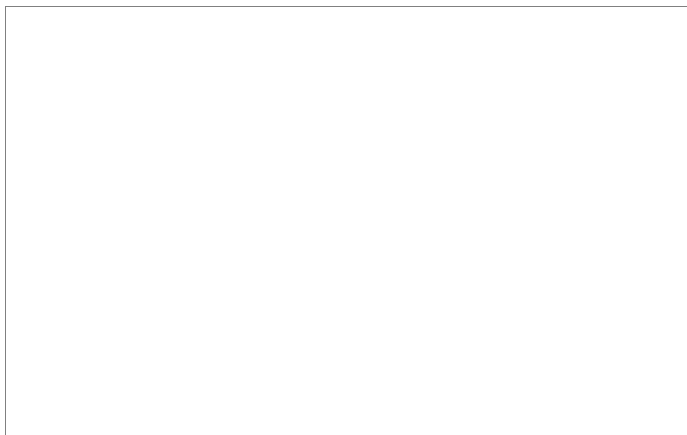
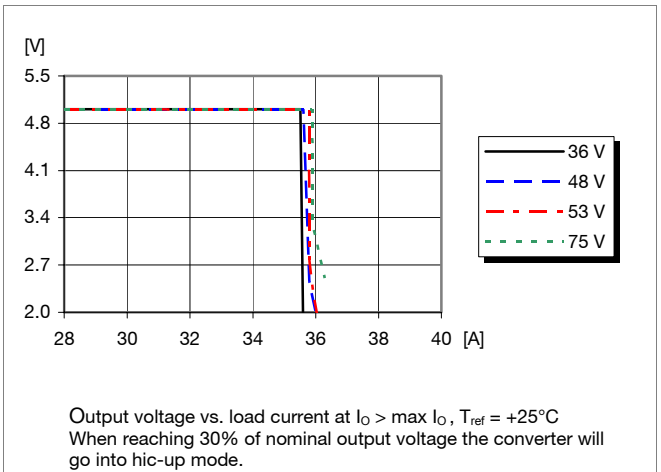

PKB4000C PI  
DC/DC converters, Input 36-75 V, Output 60A/144W

EN/LZT 146 377 R3G Oct 2008  
© Ericsson Power Modules AB

**5.0 V/28 A Typical Characteristics**

**PKB 4111C PI**

**Start-up**

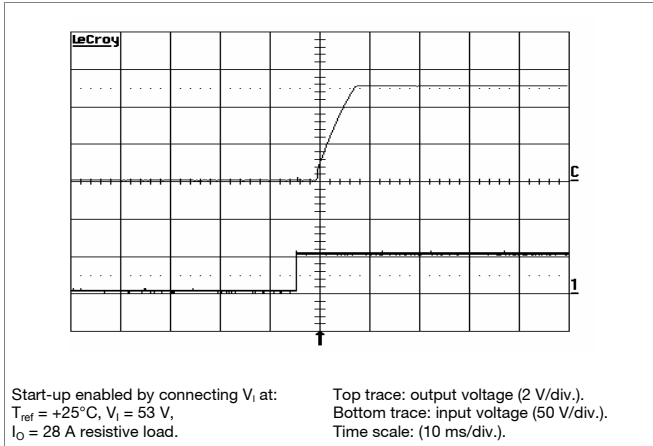

**Shut-down**

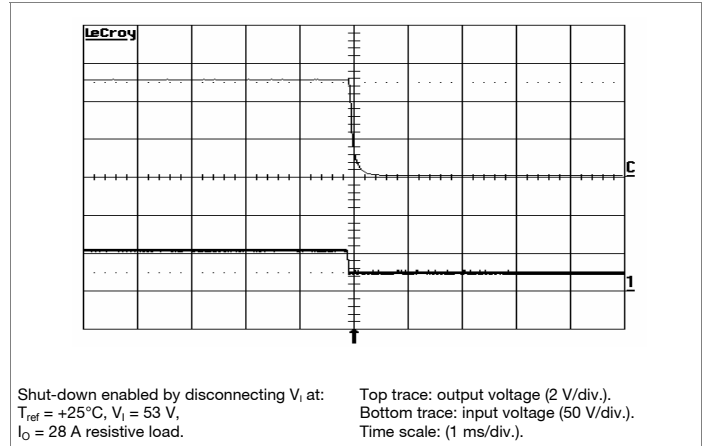

**Output Ripple & Noise**

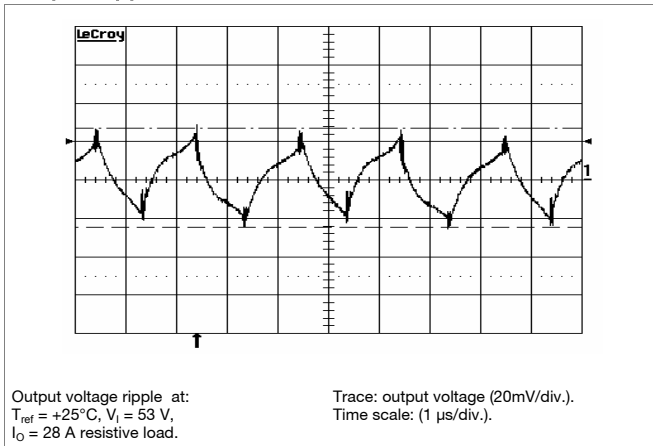

**Output Load Transient Response**

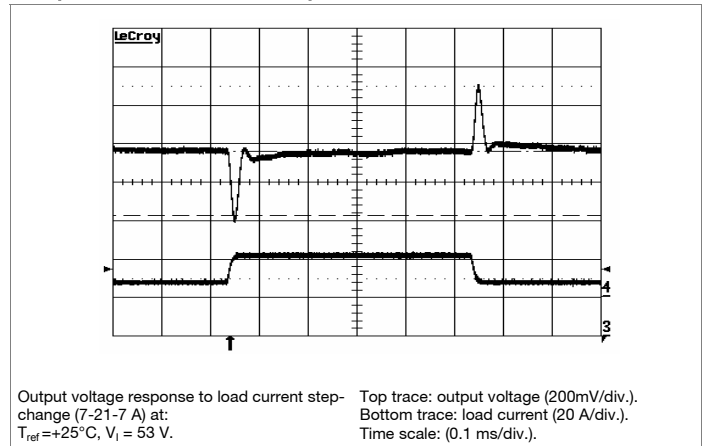

**Output Voltage Adjust (see operating information)**

**Passive adjust**

The resistor value for an adjusted output voltage is calculated by using the following equations:

Output Voltage Adjust Upwards, Increase:

$$R_{adj} = 5.11 \times \left( \frac{5 \times (100 + \Delta\%) - (100 + 2 \times \Delta\%)}{1.225 \times \Delta\%} \right) \text{ k}\Omega$$

Example: Increase 4%  $\Rightarrow V_{out} = 5.2\text{ Vdc}$

$$5.11 \times \left( \frac{5 \times (100 + 4) - (100 + 2 \times 4)}{1.225 \times 4} \right) \text{ k}\Omega = 404 \text{ k}\Omega$$

Output Voltage Adjust Downwards, Decrease:

$$R_{adj} = 5.11 \times \left( \frac{100}{\Delta\%} - 2 \right) \text{ k}\Omega$$

Example: Decrease 2%  $\Rightarrow V_{out} = 4.9\text{ Vdc}$

$$5.11 \times \left( \frac{100}{2} - 2 \right) \text{ k}\Omega = 245 \text{ k}\Omega$$

PKB4000C PI  
DC/DC converters, Input 36-75 V, Output 60A/144W

EN/LZT 146 377 R3G Oct 2008  
© Ericsson Power Modules AB

**5.0 V/28 A Typical Characteristics**

**PKB 4111C PI**

**Output Current Derating – Open frame**

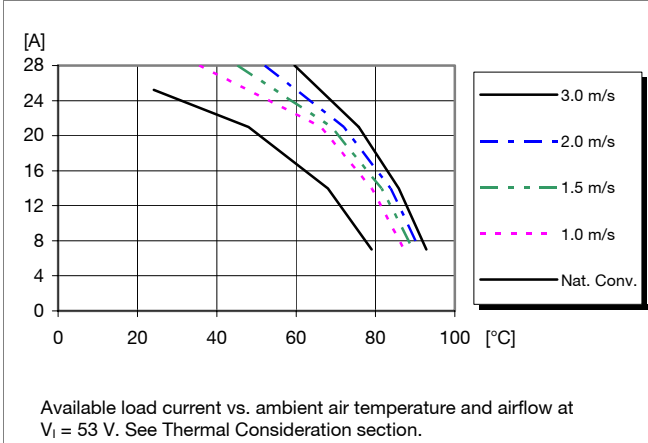

**Output Current Derating – Base plate**

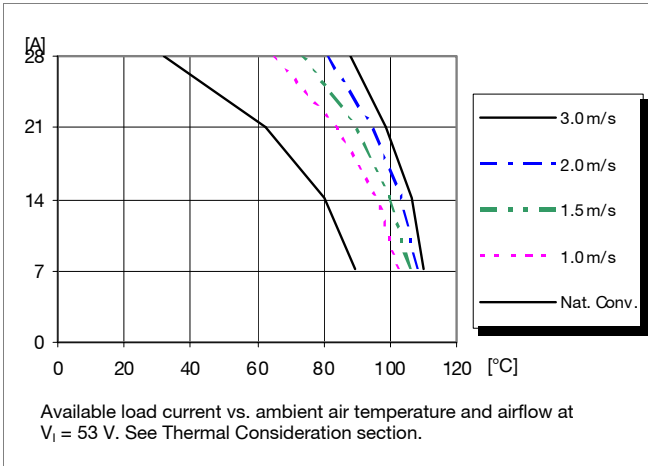

**Thermal Resistance – Base plate**

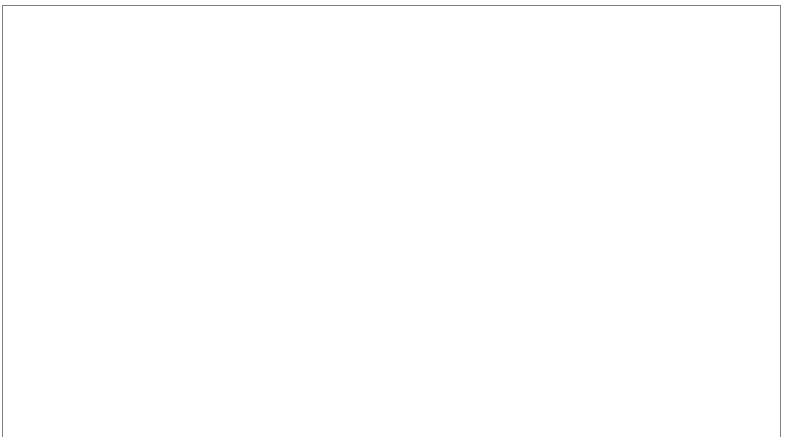
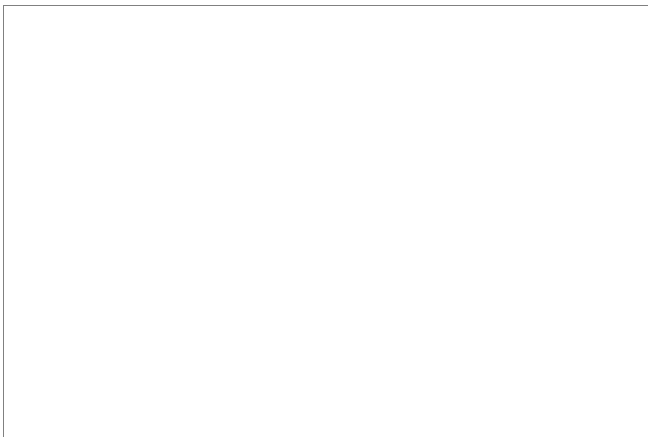
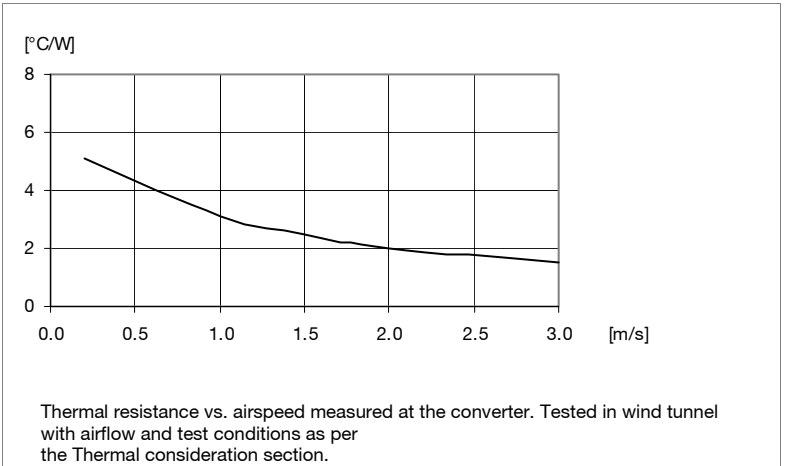



PKB4000C PI DC/DC converters, Input 36-75 V, Output 60A/144W	EN/LZT 146 377 R3G Oct 2008
	© Ericsson Power Modules AB

**12 V/12 A Electrical Specification**
**PKB 4113C PI**

$T_{ref} = -40$  to  $+90^{\circ}\text{C}$ ,  $V_I = 36$  to  $75$  V, sense pins connected to output pins unless otherwise specified under Conditions.

Typical values given at:  $T_{ref} = +25^{\circ}\text{C}$ ,  $V_I = 53$  V, max  $I_O$ , unless otherwise specified under Conditions.

Characteristics		Conditions	min	typ	max	Unit
$V_I$	Input voltage range		36		75	V
$V_{loff}$	Turn-off input voltage	Decreasing input voltage	29	31	33	V
$V_{lon}$	Turn-on input voltage	Increasing input voltage	30	33	36	V
$C_I$	Internal input capacitance			1		$\mu\text{F}$
$P_O$	Output power		0		144	W
$\eta$	Efficiency	50 % of max $I_O$		92.5		%
		max $I_O$		93		
		50 % of max $I_O$ , $V_I = 48$ V		93		
		max $I_O$ , $V_I = 48$ V		93		
$P_d$	Power Dissipation	max $I_O$		11.4	14.8	W
$P_{li}$	Input idling power	$I_O = 0$ A, $V_I = 53$ V		3.5		W
$P_{RC}$	Input standby power	$V_I = 53$ V (turned off with RC)		0.06		W
$f_s$	Switching frequency	0-100 % of max $I_O$		250		kHz

$V_{Oi}$	Output voltage initial setting and accuracy	$T_{ref} = +25^{\circ}\text{C}$ , $V_I = 53$ V, $I_O = 12$ A	11.8	12	12.2	V
$V_O$	Output adjust range	See operating information, $T_{ref} = +25^{\circ}\text{C}$ , $V_I = 53$ V	9.6		13.2	V
	Output voltage tolerance band	10-100% of max $I_O$	11.7		12.3	V
	Idling voltage	$I_O = 0$ A	11.7		12.3	V
	Line regulation	max $I_O$		2	5	mV
	Load regulation	$V_I = 53$ V, 1-100% of max $I_O$		3	10	mV
$V_{tr}$	Load transient voltage deviation	$V_I = 53$ V, Load step 25-75-25 % of max $I_O$ , $di/dt = 1$ A/ $\mu\text{s}$ , see Note 2		$\pm 600$		mV
$t_{tr}$	Load transient recovery time			50		$\mu\text{s}$
$t_r$	Ramp-up time (from 10-90 % of $V_O$ )	10-100% of max $I_O$		12	15	ms
$t_s$	Start-up time (from $V_I$ connection to 90% of $V_O$ )	$T_{ref} = 25^{\circ}\text{C}$ , $V_I = 53$ V		18	32	ms
$t_f$	$V_{in}$ shutdown fall time (from $V_{I,off}$ to 10% of $V_O$ )	max $I_O$		0.2		ms
		$I_O = 0$ A		5.7		s
$t_{RC}$	RC start-up time	max $I_O$		16		ms
	RC shutdown fall time (from RC off to 10% of $V_O$ )	max $I_O$		0.2		ms
		$I_O = 0$ A		5.7		s
$I_O$	Output current		0		12	A
$I_{lim}$	Current limit threshold	$V_O = 11.6$ V, $T_{ref} < \text{max } T_{ref}$	13	16.6	20	A
$I_{sc}$	Short circuit current	$T_{ref} = 25^{\circ}\text{C}$ , $V_O < 0.5$ V, see Note 3		7		A
$V_{Oac}$	Output ripple & noise	See ripple & noise section, max $I_O$ , $V_{Oi}$		40	120	mVp-p
OVP	Over voltage protection	$T_{ref} = +25^{\circ}\text{C}$ , $V_I = 53$ V, 10-100% of max $I_O$		15.6		V

Note 2: Output filter according to Ripple & Noise section.

Note 3: RMS current in hiccup mode.

PKB4000C PI  
DC/DC converters, Input 36-75 V, Output 60A/144W

EN/LZT 146 377 R3G Oct 2008  
© Ericsson Power Modules AB

**12 V/12 A Typical Characteristics**

**PKB 4113C PI**

**Efficiency**

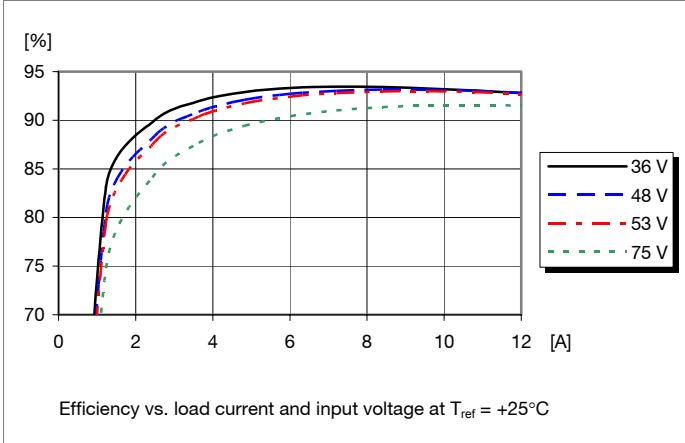

**Power Dissipation**

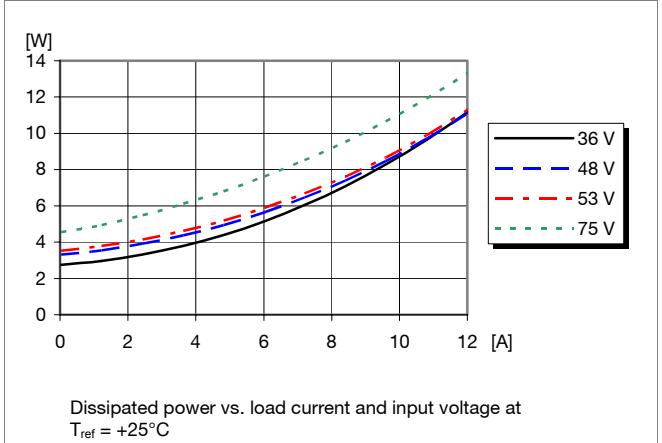

**Output Characteristics**

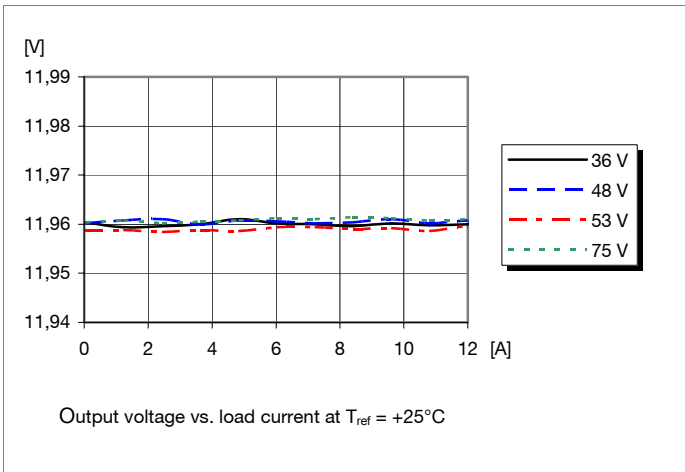

**Current Limit Characteristics**

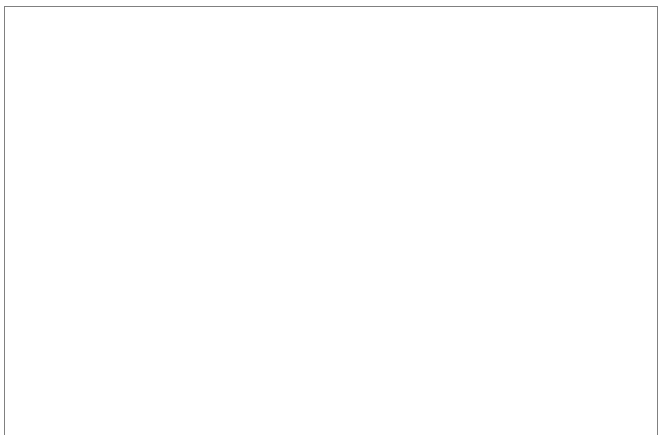
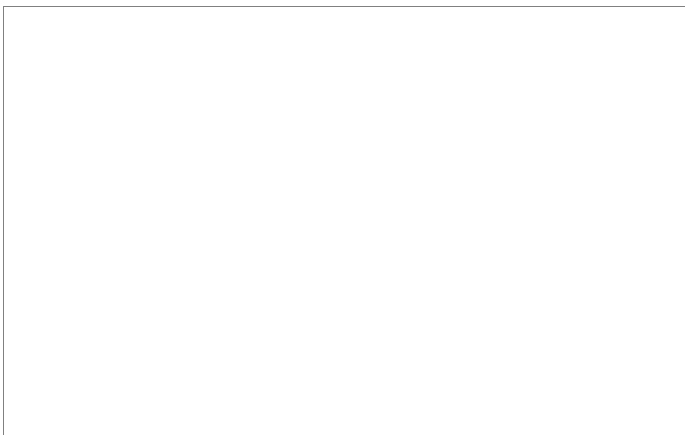
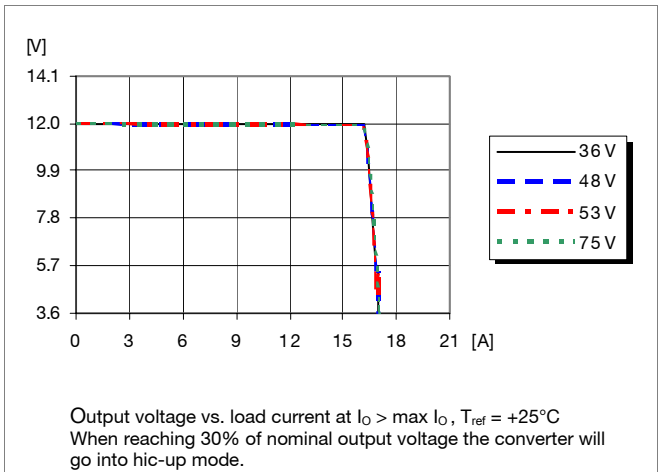

PKB4000C PI  
DC/DC converters, Input 36-75 V, Output 60A/144W

EN/LZT 146 377 R3G Oct 2008  
© Ericsson Power Modules AB

**12 V/12 A Typical Characteristics**

**PKB 4113C PI**

**Start-up**

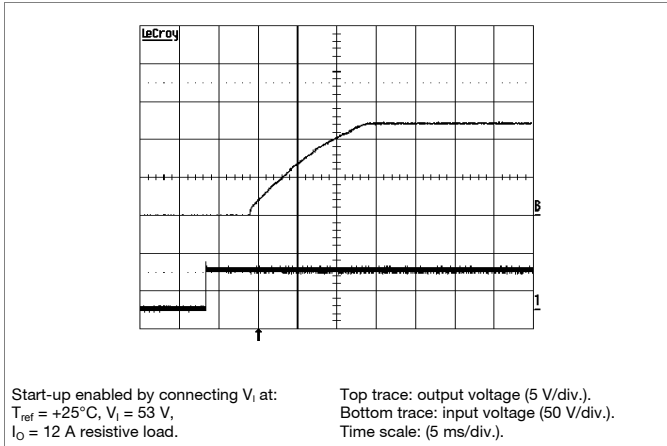

**Shut-down**

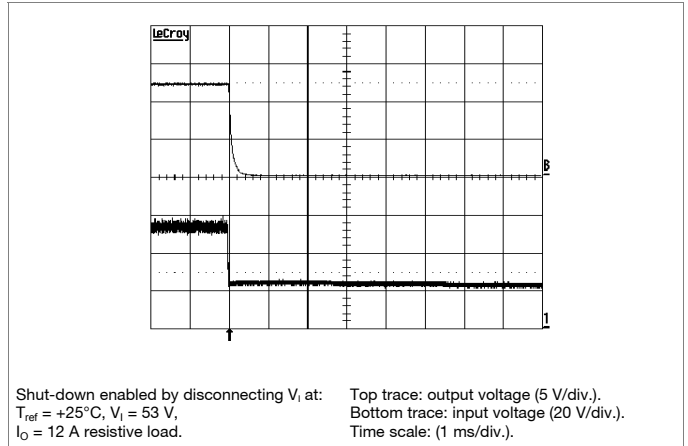

**Output Ripple & Noise**

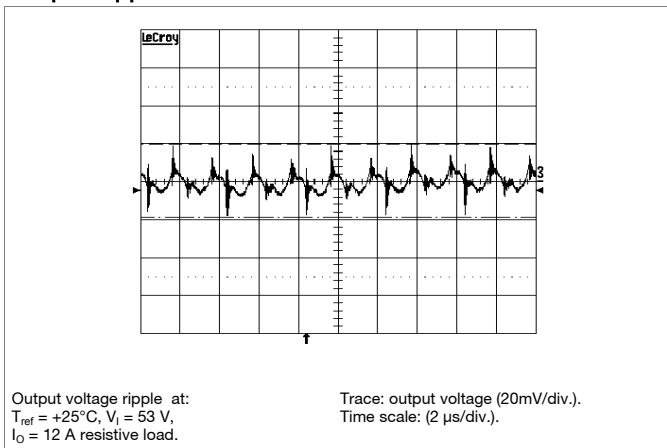

**Output Load Transient Response**

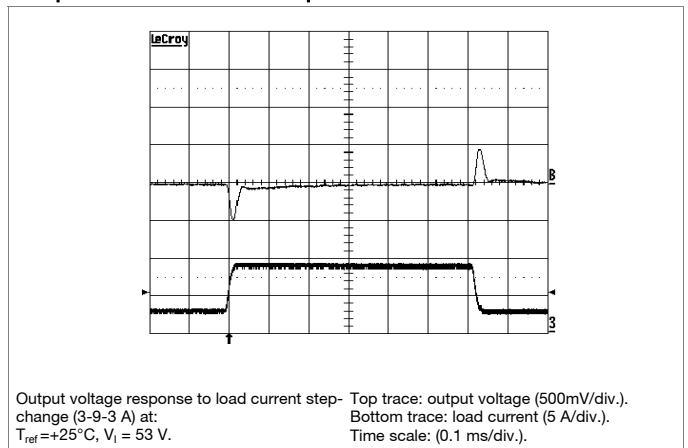

**Output Voltage Adjust (see operating information)**

**Passive adjust**

The resistor value for an adjusted output voltage is calculated by using the following equations:

Output Voltage Adjust Upwards, Increase:

$$R_{adj} = 5.11 \times \left( \frac{12(100 + \Delta\%)}{1.225 \times \Delta\%} - \frac{(100 + 2 \times \Delta\%)}{\Delta\%} \right) \text{ k}\Omega$$

Example: Increase 4% =>  $V_{out} = 12.48\text{ Vdc}$

$$5.11 \times \left( \frac{12(100 + 4)}{1.225 \times 4} - \frac{(100 + 2 \times 4)}{4} \right) \text{ k}\Omega = 1164 \text{ k}\Omega$$

Output Voltage Adjust Downwards, Decrease:

$$R_{adj} = 5.11 \times \left( \frac{100}{\Delta\%} - 2 \right) \text{ k}\Omega$$

Example: Decrease 2% =>  $V_{out} = 11.76\text{ Vdc}$

$$5.11 \times \left( \frac{100}{2} - 2 \right) \text{ k}\Omega = 245 \text{ k}\Omega$$

PKB4000C PI  
DC/DC converters, Input 36-75 V, Output 60A/144W

EN/LZT 146 377 R3G Oct 2008  
© Ericsson Power Modules AB

**12 V/12 A Typical Characteristics**

**PKB 4113C PI**

**Output Current Derating – Open frame**

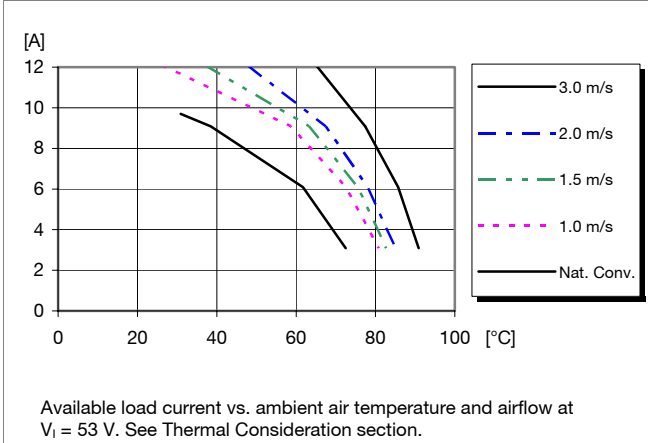

**Output Current Derating – Base plate**

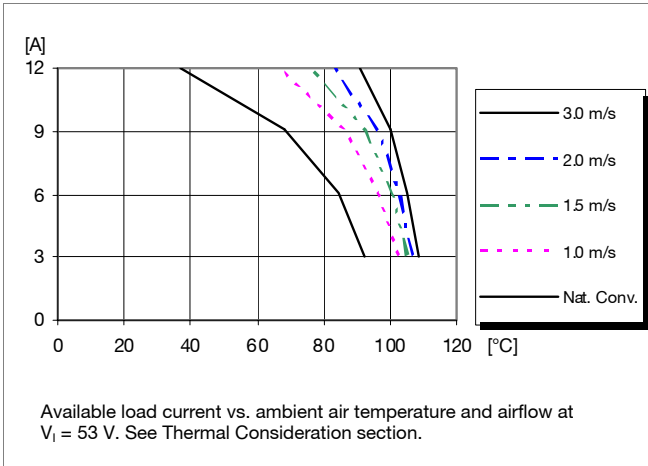

**Thermal Resistance – Base plate**

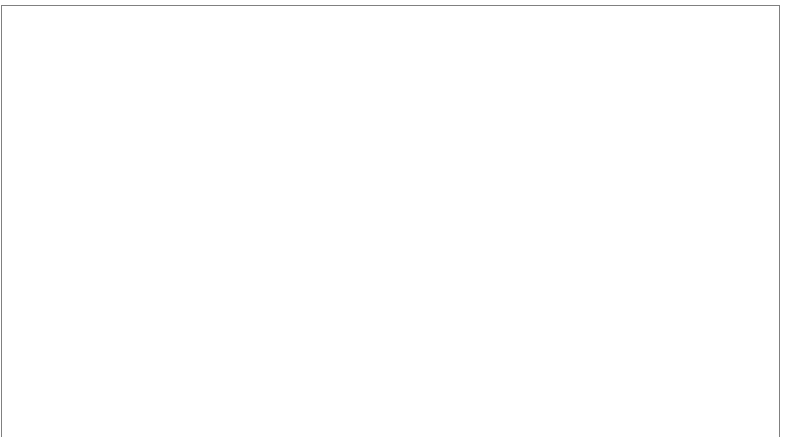
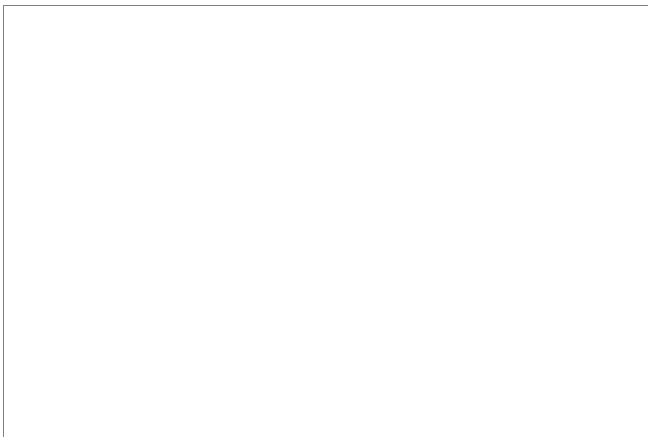
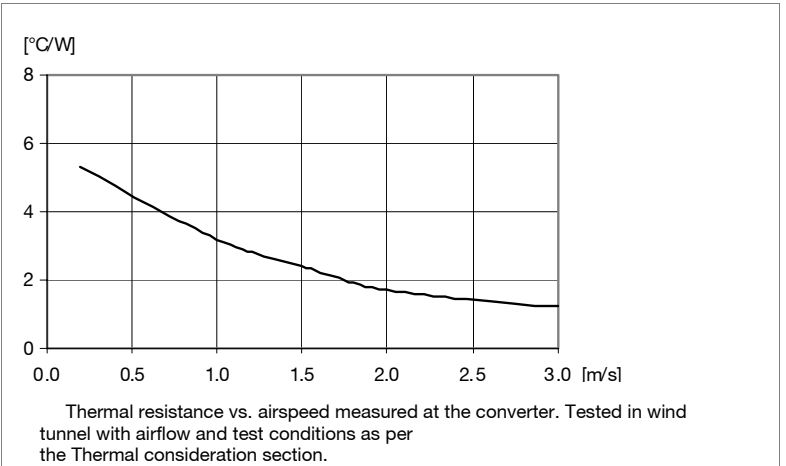

PKB400C PI  
DC/DC converters, Input 36-75 V, Output 60A/144W

EN/LZT 146 377 R3G Oct 2008

© Ericsson Power Modules AB

**EMC Specification**

Conducted EMI measured according to EN55022, CISPR 22 and FCC part 15J (see test set-up). See Design Note 009 for further information. The fundamental switching frequency is 250 kHz for PKB 4111C @  $V_I = 53 V$ , max  $I_O$ .

**Conducted EMI Input terminal value (typ)**

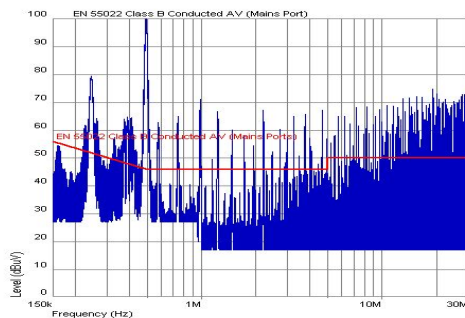

EMI without filter

**External filter (class B)**

Required external input filter in order to meet class B in EN 55022, CISPR 22 and FCC part 15J.

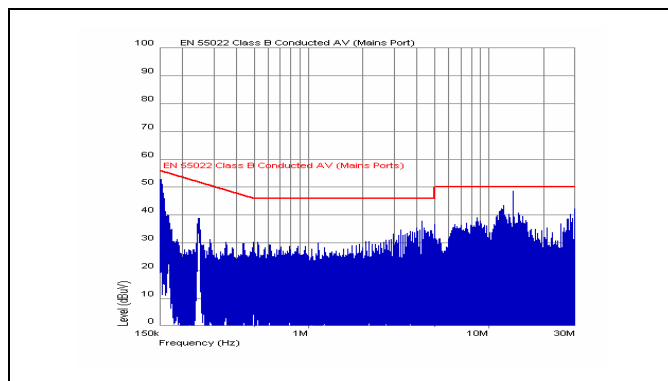
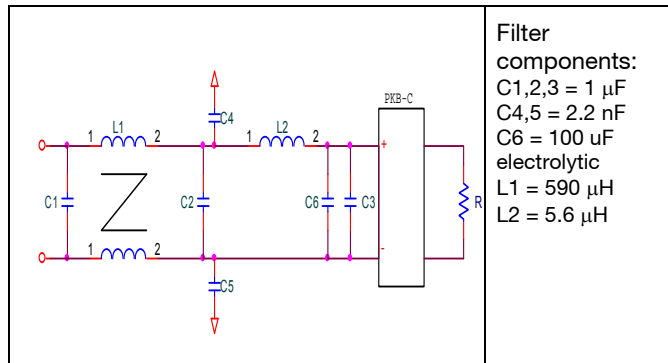

EMI with filter

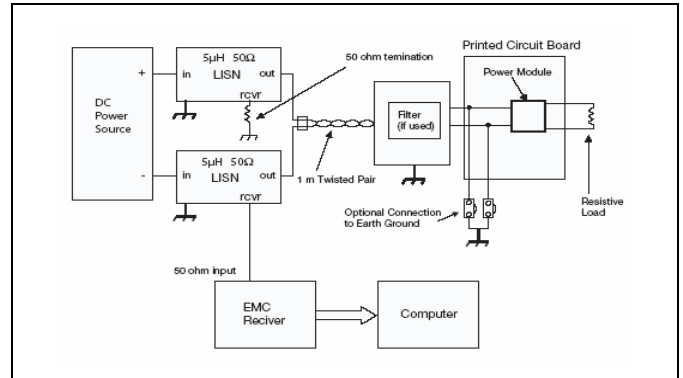

Test set-up

**Layout recommendation**

The radiated EMI performance of the DC/DC converter will depend on the PCB layout and ground layer design. It is also important to consider the stand-off of the DC/DC converter.

If a ground layer is used, it should be connected to the output of the DC/DC converter and the equipment ground or chassis.

A ground layer will increase the stray capacitance in the PCB and improve the high frequency EMC performance.

**Output ripple and noise**

Output ripple and noise measured according to figure below. See Design Note 022 for detailed information.

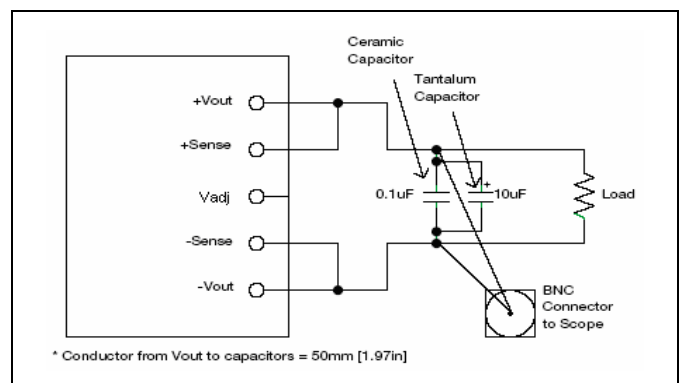

Output ripple and noise test setup

PKB4000C PI  
DC/DC converters, Input 36-75 V, Output 60A/144W

EN/LZT 146 377 R3G Oct 2008  
© Ericsson Power Modules AB

**Operating information**

**Input Voltage**

The input voltage range 36 to 75Vdc meets the requirements of the European Telecom Standard ETS 300 132-2 for normal input voltage range in -48 and -60 Vdc systems, -40.5 to -57.0 V and -50.0 to -72 V respectively. At input voltages exceeding 75 V, the power loss will be higher than at normal input voltage and  $T_{ref}$  must be limited to absolute max +90°C. The absolute maximum continuous input voltage is 80 Vdc.

**Turn-off Input Voltage**

The DC/DC converters monitor the input voltage and will turn on and turn off at predetermined levels. The minimum hysteresis between turn on and turn off input voltage is 1V.

**Remote Control (RC)**

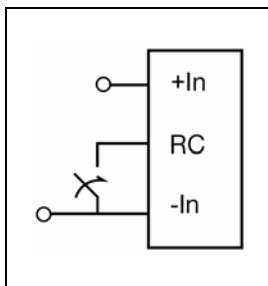

The products are fitted with a remote control function referenced to the primary negative input connection (- In), with negative and positive logic options available. The RC function allows the converter to be turned on/off by an external device like a semiconductor or mechanical switch. The RC pin has an internal pull up resistor to + In.

The maximum required sink current is 1 mA. When the RC pin is left open, the voltage generated on the RC pin is 4 – 6 V. The second option is “positive logic” remote control, which can be ordered by adding the suffix “P” to the end of the part number. The converter will turn on when the input voltage is applied with the RC pin open. Turn off is achieved by connecting the RC pin to the - In. To ensure safe turn off the voltage difference between RC pin and the - In pin shall be less than 1V. The converter will restart automatically when this connection is opened.

See Design Note 021 for detailed information.

**Input and Output Impedance**

The impedance of both the input source and the load will interact with the impedance of the DC/DC converter. It is important that the input source has low characteristic impedance. The converters are designed for stable operation without external capacitors connected to the input or output. The performance in some applications can be enhanced by addition of external capacitance as described under External Decoupling Capacitors. If the input voltage source contains significant inductance, the addition of a 100 µF capacitor across the input of the converter will ensure stable operation. The capacitor is not required when powering the DC/DC converter from an input source with an inductance below 10 µH.

**External Decoupling Capacitors**

When powering loads with significant dynamic current requirements, the voltage regulation at the point of load can be improved by addition of decoupling capacitors at the load. The most effective technique is to locate low ESR ceramic and electrolytic capacitors as close to the load as possible, using several parallel capacitors to lower the effective ESR. The ceramic capacitors will handle high-frequency dynamic load changes while the electrolytic capacitors are used to handle low frequency dynamic load changes. Ceramic capacitors will also reduce any high frequency noise at the load.

It is equally important to use low resistance and low inductance PCB layouts and cabling. External decoupling capacitors will become part of the control loop of the DC/DC converter and may affect the stability margins. As a “rule of thumb”, 100 µF/A of output current can be added without any additional analysis. The ESR of the capacitors is a very important parameter. Power Modules guarantee stable operation with a verified ESR value of >10 mΩ across the output connections. For further information please contact your local Ericsson Power Modules representative.

**Output Voltage Adjust ( $V_{adj}$ )**

The DC/DC converters have an Output Voltage Adjust pin ( $V_{adj}$ ). This pin can be used to adjust the output voltage above or below Output voltage initial setting. When increasing the output voltage, the voltage at the output pins (including any remote sense compensation ) must be kept below the threshold of the over voltage protection, (OVP) to prevent the converter from shutting down. At increased output voltages the maximum power rating of the converter remains the same, and the max output current must be decreased correspondingly. To increase the voltage the resistor should be connected between the  $V_{adj}$  pin and +Sense pin. The resistor value of the Output voltage adjust function is according to information given under the Output section for the respective product. To decrease the output voltage, the resistor should be connected between the  $V_{adj}$  pin and -Sense pin.

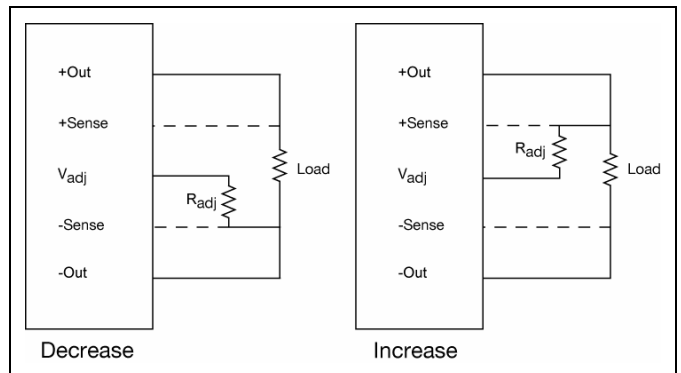

PKB4000C PI DC/DC converters, Input 36-75 V, Output 60A/144W	EN/LZT 146 377 R3G Oct 2008 © Ericsson Power Modules AB
---	--

## Operating information continued

### Parallel Operation

Two converters may be paralleled for redundancy if the total power is equal or less than  $P_O$  max. It is not recommended to parallel the converters without using external current sharing circuits.

See Design Note 006 for detailed information.

### Remote Sense

The DC/DC converters have remote sense that can be used to compensate for voltage drops between the output and the point of load. The sense traces should be located close to the PCB ground layer to reduce noise susceptibility. The remote sense circuitry will compensate for up to 10% voltage drop between output pins and the point of load.

If the remote sense is not needed +Sense should be connected to +Out and -Sense should be connected to -Out.

### Over Temperature Protection (OTP)

The converters are protected from thermal overload by an internal over temperature shutdown circuit.

When  $T_{ref}$  as defined in thermal consideration section exceeds 135°C the converter will shut down. The DC/DC converter will make continuous attempts to start up (non-latching mode) and resume normal operation automatically when the temperature has dropped >10°C below the temperature threshold.

The converters with latching option will shut down the module when  $T_{ref}$  exceeds 135°C and remain shut down until the module restarts by switching on/off the input voltage or Remote control.

### Over Voltage Protection (OVP)

The converters have output over voltage protection that will shut down the converter in over voltage conditions. The converter will make continuous attempts to start up (non-latching mode) and resume normal operation automatically after removal of the over voltage condition.

The converters with latching option will shut down the module in over voltage condition and remain shut down until the converter restarts by switching on/off the input voltage or Remote control.

### Over Current Protection (OCP)

The converters include current limiting circuitry for protection at continuous overload.

The output voltage will decrease towards 30% of nominal output voltage for output currents in excess of max output current (max  $I_O$ ). When reaching 30% of nominal output voltage the converter will go into hic-up mode. The converter will resume normal operation after removal of the overload. The load distribution should be designed for the maximum output short circuit current specified.

The converters with latching option will shut down the module when reaching 30% of nominal output voltage and remain shut down until the converter restarts by switching on/off the input voltage or Remote control.

### Pre-bias Start-up

The converter has a Pre-bias start up functionality. The converter will sink current in a controlled way during start up if a pre-bias source is present at the output terminals.

PKB4000C PI DC/DC converters, Input 36-75 V, Output 60A/144W	EN/LZT 146 377 R3G Oct 2008
	© Ericsson Power Modules AB

**Thermal Consideration**

**General**

The converters are designed to operate in different thermal environments and sufficient cooling must be provided to ensure reliable operation. Cooling is achieved mainly by conduction, from the pins to the host board, and convection, which is dependant on the airflow across the converter. Increased airflow enhances the cooling of the converter.

The Output Current Derating graph found in the Output section for each model provides the available output current vs. ambient air temperature and air velocity at  $V_{in} = 53 V$ .

The DC/DC converter is tested on a 254 x 254 mm, 35  $\mu m$  (1 oz), 8-layer test board mounted vertically in a wind tunnel with a cross-section of 305 x 305 mm.

Proper cooling of the DC/DC converter can be verified by measuring the temperature at positions P1 or P2 ( see note 1). The temperature at these positions should not exceed the max values provided in the table below.

Note that the max value is the absolute maximum rating (non destruction) and that the electrical Output data is guaranteed up to  $T_{ref} + 90^{\circ}C$ .

See Design Note 019 for further information.

Position	Device	Designation	max value
P <sub>1</sub>	Mosfet	$T_{ref}$	125° C
P <sub>2</sub>	Ind. core	$T_{ref}$	125° C

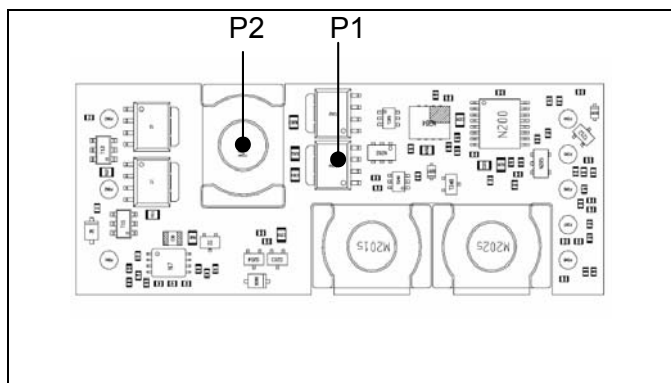

**Thermal Consideration continued**

The PKB4000C series DC/DC converters can be ordered with a heatsink (HS) option. The HS option is intended to be mounted on a cold wall or heatsink to transfer heat away from the converter and further improve the cooling of the converter.

**Definition of reference temperature ( $T_{ref}$ )**

The reference temperature is used to monitor the temperature limits of the product. Temperatures above maximum  $T_{ref}$  are

not allowed and may cause degradation or permanent damage to the product.  $T_{ref}$  is also used to define the temperature range for normal operating conditions.  $T_{ref}$  is defined by the design and used to guarantee safety margins, proper operation and high reliability of the module.

**Ambient Temperature Calculation**

By using the thermal resistance the maximum allowed ambient temperature can be calculated.

1. The power loss is calculated by using the formula  $((1/\eta) - 1) \times \text{output power} = \text{power losses (Pd)}$ .  $\eta$  = efficiency of converter. E.g. 89.5 % = 0.895
2. Find the thermal resistance (Rth) in the Thermal Resistance graph found in the Output section for each model. Calculate the temperature increase ( $\Delta T$ ).  $\Delta T = Rth \times Pd$
3. Max allowed ambient temperature is:  $\text{Max } T_{ref} - \Delta T$ .

E.g. PKB 4110C PI at 1m/s:

1.  $((\frac{1}{0.90}) - 1) \times 132 W = 14.7 W$
2.  $14.7 W \times 4.6^{\circ}C/W = 68^{\circ}C$
3.  $125^{\circ}C - 68^{\circ}C = \text{max ambient temperature is } 57^{\circ}C$

The actual temperature will be dependent on several factors such as the PCB size, number of layers and direction of airflow.

Note 1  
 P2 is the limiting component ( $T_{ref}$ ) used for thermal derating for PKB4113C. P1 is used for the rest of the modules in the PKB-C family.



PKB4000C PI  
DC/DC converters, Input 36-75 V, Output 60A/144W

EN/LZT 146 377 R3G Oct 2008

© Ericsson Power Modules AB

**Connections**

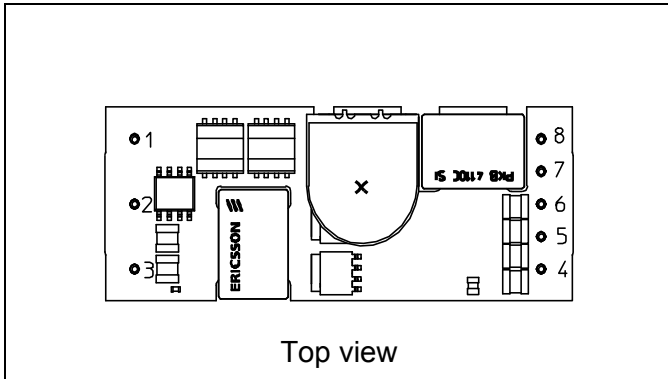

Top view

Pin	Designation	Function
1	+In	Positive input
2	RC	Remote control
3	-In	Negative input
4	-Out	Negative output
5	-Sen	Negative remote sense
6	Vadj	Output voltage adjust
7	+Sen	Positive remote sense
8	+Out	Positive output

PKB4000C PI  
DC/DC converters, Input 36-75 V, Output 60A/144W

EN/LZT 146 377 R3G Oct 2008  
© Ericsson Power Modules AB

**Mechanical Information - Surface Mount Version**

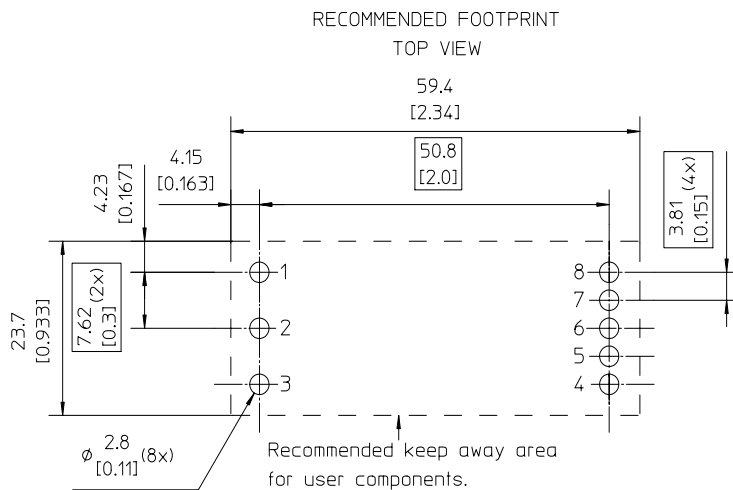
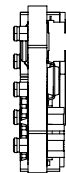
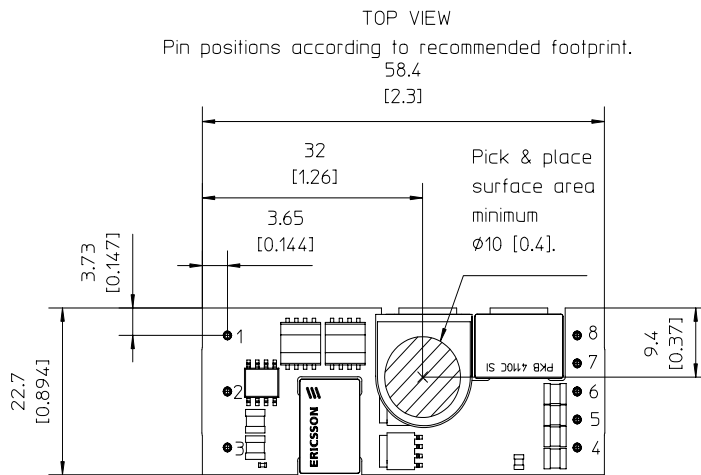
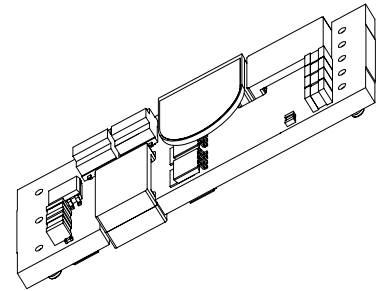
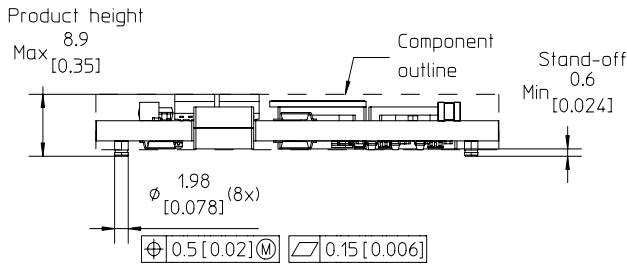

Layout considerations:  
Use sufficient numbers of vias connected to output pin pads for good thermal and current conductivity.

Pins:  
Material: Copper alloy  
Plating: 0.1  $\mu$ m Au over 2  $\mu$ m Ni

Weight: 21 g typical

All dimensions in mm [inch].  
Tolerances unless specified:  
X.x mm  $\pm$ 0.5 mm [0.02]

X.xx mm  $\pm$ 0.25 mm [0.01]  
(not applied on footprint or typical values)



PKB4000C PI  
DC/DC converters, Input 36-75 V, Output 60A/144W

EN/LZT 146 377 R3G Oct 2008  
© Ericsson Power Modules AB

**Mechanical Information - Through Hole Mount – Open Frame Version**

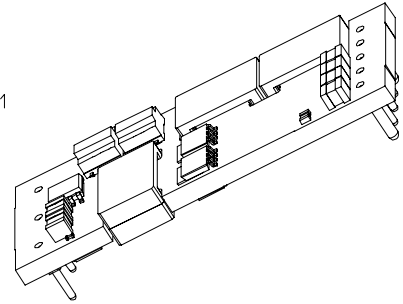
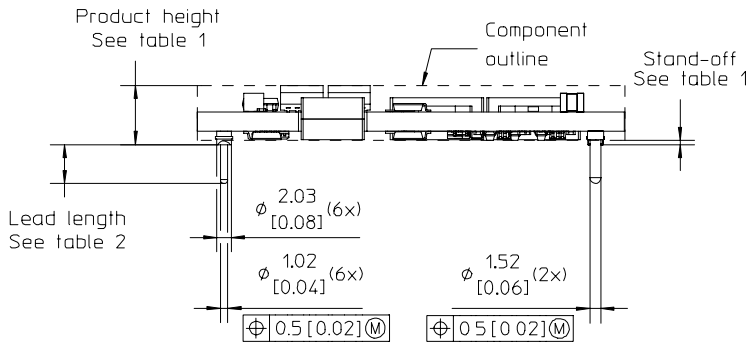

TOP VIEW  
Pin positions according to recommended footprint.

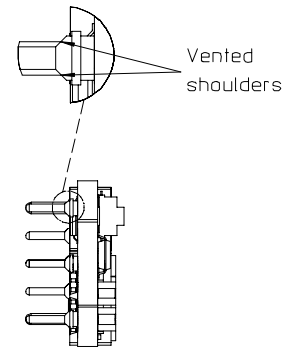
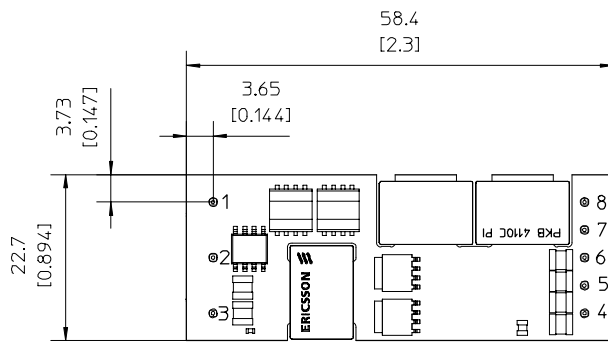

RECOMMENDED FOOTPRINT  
TOP VIEW

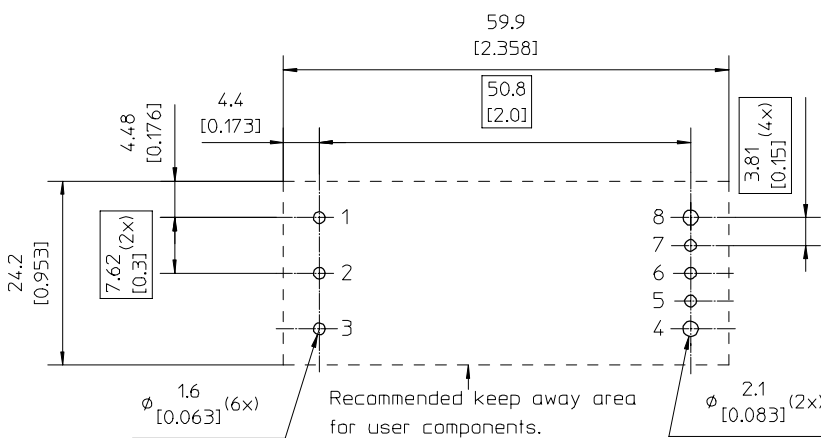

Table 1

Height option	Height Max.	Stand-off Min.
Standard	8.6 [0.34]	0.25 [0.01]
M	9.6 [0.38]	1.25 [0.05]

Table 2

Pin option	Lead Length
Standard	5.33 [0.21]
LA	3.69 [0.145]
LB	4.57 [0.18] (cut)

Pins:

Material:

Pins 1-3, 5-7: Brass

Pins 4,8: Copper alloy

Plating: 0.1 μm Au over 2 μm Ni

Weight: 21 g typical

All dimensions in mm [inch].

Tolerances unless specified:

X.x mm ±0.5 mm [0.02]

X.xx mm ±0.25 mm [0.01]

(not applied on footprint or typical values)



PKB4000C PI  
DC/DC converters, Input 36-75 V, Output 60A/144W

EN/LZT 146 377 R3G Oct 2008

© Ericsson Power Modules AB

**Mechanical Information – Through Hole Mount – Base Plate Version**

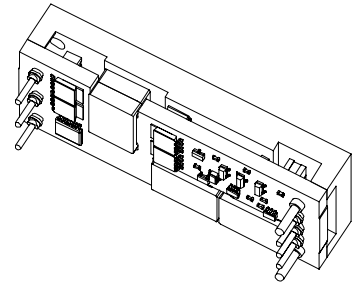
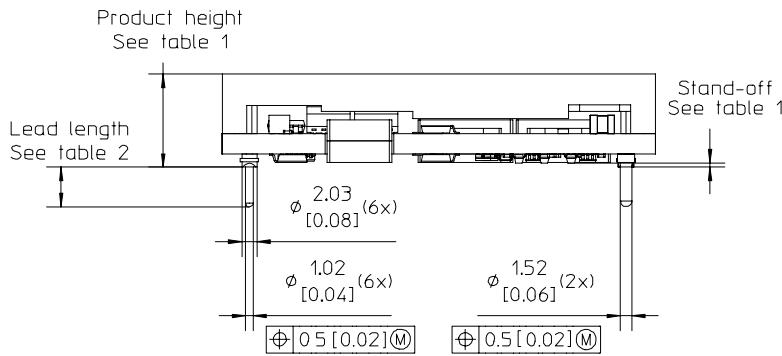

TOP VIEW  
Pin positions according to recommended footprint.

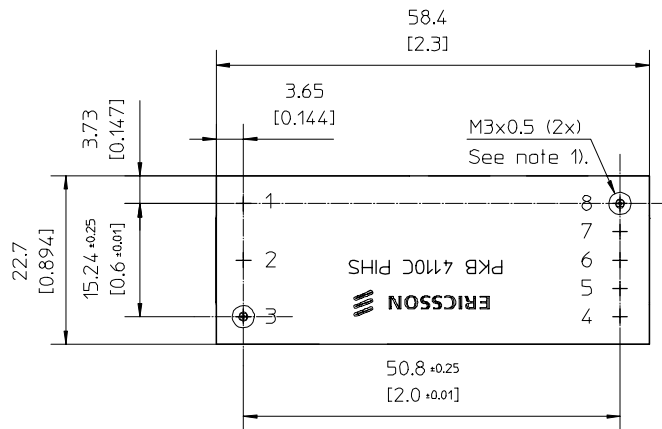

RECOMMENDED FOOTPRINT

TOP VIEW

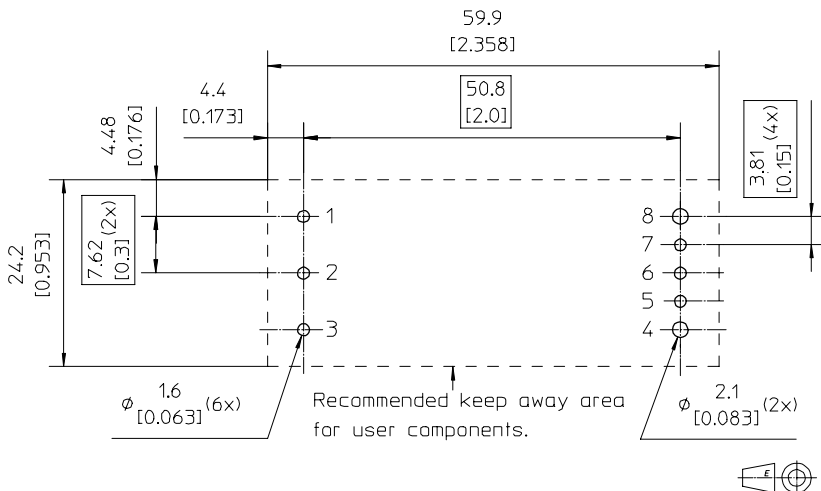

Table 1

Height option	Height Max.	Stand-off Min.
Standard	12.7 [0.5]	0.25 [0.01]
M	13.7 [0.54]	1.25 [0.05]

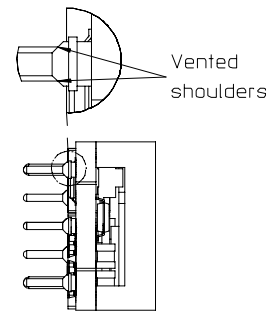

Table 2

Pin option	Lead Length
Standard	5.33 [0.21]
LA	3.69 [0.145]
LB	4.57 [0.18] (cut)

Case: Aluminium base plate  
For screw attachment, apply mounting torque of max 0.44 Nm [3.9 lbf in]  
1). Max screw intrusion in base plate 4 [0.16].

Pins:  
Material:  
Pins 1-3, 5-7: Brass  
Pins 4,8: Copper alloy  
Plating: 0.1 µm Au over 2 µm Ni

Weight: 40 g typical

All dimensions in mm [inch].  
Tolerances unless specified:  
X.x mm ±0.5 mm [0.02]  
X.xx mm ±0.25 mm [0.01]  
(not applied on footprint or typical values)

PKB4000C PI  
DC/DC converters, Input 36-75 V, Output 60A/144W

EN/LZT 146 377 R3G Oct 2008

© Ericsson Power Modules AB

**Soldering Information - Surface Mounting**

The surface mount version of the product is intended for convection or vapor phase reflow SnPb and Pb-free processes. To achieve a good and reliable soldering result, make sure to follow the recommendations from the solder paste supplier, to use state-of-the-art reflow equipment and reflow profiling techniques as well as the following guidelines.

A no-clean flux is recommended to avoid entrapment of cleaning fluids in cavities inside the product or between the product and the host board. The cleaning residues may affect long time reliability and isolation voltage.

**Minimum Pin Temperature Recommendations**

Pin number 4 is chosen as reference location for the minimum pin temperature recommendations since this will likely be the coolest solder joint during the reflow process.

Pin 2 for measurement of maximum peak product reflow temperature,  $T_P$

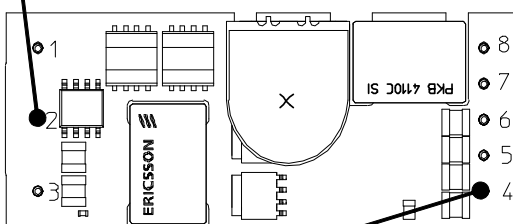

Pin 4 for measurement of minimum solder joint temperature,  $T_{PIN}$

**SnPb solder processes**

For SnPb solder processes, a pin temperature ( $T_{PIN}$ ) in excess of the solder melting temperature, ( $T_L$ , +183°C for Sn63/Pb37) for more than 30 seconds, and a peak temperature of +210°C is recommended to ensure a reliable solder joint.

**Lead-free (Pb-free) solder processes**

For Pb-free solder processes, a pin temperature ( $T_{PIN}$ ) in excess of the solder melting temperature ( $T_L$ , +217 to +221°C for Sn/Ag/Cu solder alloys) for more than 30 seconds, and a peak temperature of +235°C on all solder joints is recommended to ensure a reliable solder joint.

**Peak Product Temperature Requirements**

Pin number 2 is chosen as reference location for the maximum (peak) allowed product temperature ( $T_P$ ) since this will likely be the warmest part of the product during the reflow process.

To avoid damage or performance degradation of the product, the reflow profile should be optimized to avoid excessive heating. A sufficiently extended preheat time is recommended to ensure an even temperature across the host PCB, for both small and large devices. To reduce the risk of excessive heating is also recommended to reduce the time in the reflow zone as much as possible.

**SnPb solder processes**

For SnPb solder processes, the product is qualified for MSL 1 according to IPC/JEDEC standard J-STD-020C.

During reflow,  $T_P$  must not exceed +225°C at any time.

**Lead-free (Pb-free) solder processes**

For Pb-free solder processes, the product is qualified for MSL 3 according to IPC/JEDEC standard J-STD-020C.

During reflow,  $T_P$  must not exceed +260°C at any time.

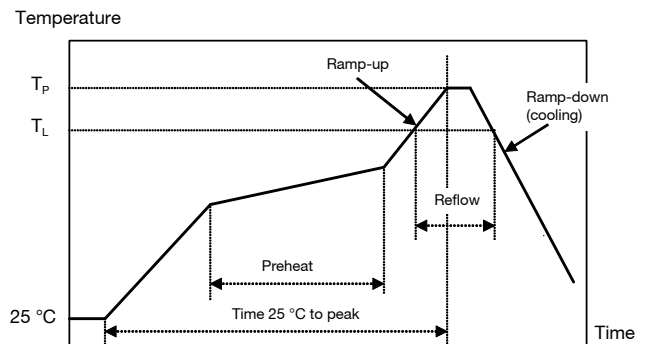

Reflow process specifications		Sn/Pb eutectic	Pb-free
Average ramp-up rate		3°C/s max	3°C/s max
Solder melting temperature (typical)	$T_L$	+183°C	+221°C
Minimum time above $T_L$		30 s	30 s
Minimum pin temperature	$T_{PIN}$	+210°C	+235°C
Peak product temperature	$T_P$	+225°C	+260°C
Average ramp-down rate		6°C/s max	6°C/s max
Time 25°C to peak		6 minutes max	8 minutes max

PKB4000C PI DC/DC converters, Input 36-75 V, Output 60A/144W	EN/LZT 146 377 R3G Oct 2008
	© Ericsson Power Modules AB

**Soldering Information – Through Hole Mounting**

The through hole mount version of the product is intended for manual or wave soldering. When wave soldering is used, the temperature on the pins is specified to maximum 270°C for maximum 10 seconds.

A maximum preheat rate of 4°C/s and a temperature of max +150°C is suggested. When soldering by hand, care should be taken to avoid direct contact between the hot soldering iron tip and the pins for more than a few seconds in order to prevent overheating.

A no-clean flux is recommended to avoid entrapment of cleaning fluids in cavities inside the product or between the product and the host board. The cleaning residues may affect long time reliability and isolation voltage.

**Delivery Package Information, Surface Mount Version**

The surface mount versions of the products are delivered in antistatic injection molded trays (Jedec design guide 4.10D standard).

Tray Specifications	
<b>Material</b>	PPE, Antistatic
<b>Surface resistance</b>	$10^5 < \text{Ohm/square} < 10^{12}$
<b>Bakability</b>	The trays can be baked at maximum 125°C for 48 hours
<b>Tray capacity</b>	20 products/tray
<b>Tray thickness</b>	14.4 mm [0.567 inch]
<b>Box capacity</b>	100 products (5 full trays/box)
<b>Tray weight</b>	110 g empty, 530 g full tray

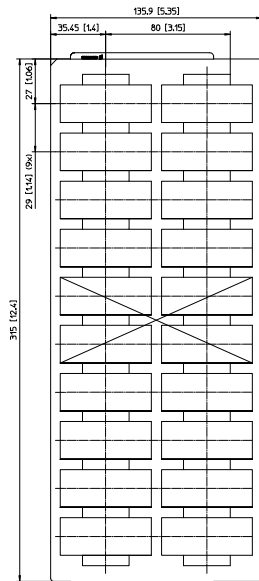

X = Vacuum pickup area.

**Dry Pack Information**

The surface mount versions of the products are delivered in trays. These inner shipment containers are dry packed in standard moisture barrier bags according to IPC/JEDEC standard J-STD-033 (Handling, packing, shipping and use of moisture/reflow sensitivity surface mount devices).

Using products in high temperature Pb-free soldering processes requires dry pack storage and handling. In case the products have been stored in an uncontrolled environment and no longer can be considered dry, the modules must be baked according to J-STD-033.

**Delivery Package Information, Through Hole versions**

The products are delivered in antistatic trays.

Tray Specifications	
<b>Material</b>	PE foam, antistatic.
<b>Surface resistance</b>	$10^5 < \text{Ohm/square} < 10^{12}$
<b>Bakability</b>	The trays are not bakable
<b>Tray capacity</b>	25 products/tray
<b>Tray thickness Open Frame version</b>	18 mm [0.71 inch]
<b>Tray thickness Base Plate version</b>	22 mm [0.87 inch]
<b>Box capacity Open Frame version</b>	100 products (4 full trays/box)
<b>Box capacity Base Plate version</b>	50 products (2 full trays/box)
<b>Tray weight Open Frame version</b>	30 g empty, 550 g full tray
<b>Tray weight Base Plate version</b>	40 g empty, 1040 g full tray

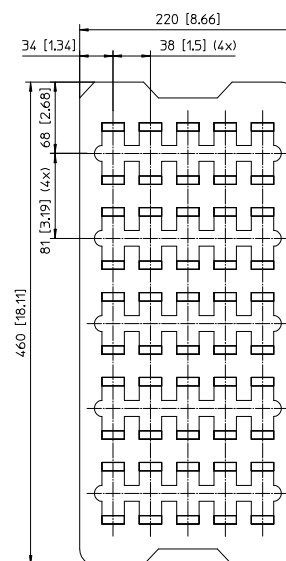

PKB4000C PI DC/DC converters, Input 36-75 V, Output 60A/144W	EN/LZT 146 377 R3G Oct 2008
	© Ericsson Power Modules AB

**Product Qualification Specification**

Characteristics			
External visual inspection	IPC-A-610		
Change of temperature (Temperature cycling)	IEC 60068-2-14 Na	Temperature range Number of cycles Dwell/transfer time	-40 to +100°C 1000 15 min/0-1 min
Cold (in operation)	IEC 60068-2-1 Ad	Temperature T <sub>A</sub> Duration	-45°C 72 h
Damp heat	IEC 60068-2-67 Cy	Temperature Humidity Duration	+85°C 85 % RH 1000 hours
Dry heat	IEC 60068-2-2 Bd	Temperature Duration	+125°C 1000 h
Electrostatic discharge susceptibility	IEC 61340-3-1, JESD 22-A114 IEC 61340-3-2, JESD 22-A115	Human body model (HBM) Machine Model (MM)	Class 2, 2000 V Class 3, 200 V
Immersion in cleaning solvents	IEC 60068-2-45 XA Method 2	Water Glycol ether Isopropyl alcohol	+55°C +35°C +35°C
Mechanical shock	IEC 60068-2-27 Ea	Peak acceleration Duration	100 g 6 ms
Moisture reflow sensitivity <sup>1</sup>	J-STD-020C	Level 1 (SnPb-eutectic) Level 3 (Pb Free)	225°C 260°C
Operational life test	MIL-STD-202G method 108A	Duration	1000 h
Resistance to soldering heat <sup>2</sup>	IEC 60068-2-20 Tb Method 1A	Solder temperature Duration	270°C 10-13 s
Robustness of terminations	IEC 60068-2-21 Test Ua1 IEC 60068-2-21 Test Ue1	Through hole mount products Surface mount products	All leads All leads
Solderability	IEC 60068-2-58 test Td <sup>1</sup>	Preconditioning Temperature, SnPb Eutectic Temperature, Pb-free	150°C dry bake 16 h 215°C 235°C
	IEC 60068-2-20 test Ta <sup>2</sup>	Preconditioning Temperature, SnPb Eutectic Temperature, Pb-free	Steam ageing 235°C 245°C
Vibration, broad band random	IEC 60068-2-64 Fh, method 1	Frequency Spectral density Duration	10 to 500 Hz 0.07 g <sup>2</sup> /Hz 10 min in each perpendicular direction

Note 1: Only for products intended for reflow soldering (surface mount products)

Note 2: Only for products intended for wave soldering (plated through hole products)