

PKM 4000C PINB series
DC/DC converters, Input 36-75 V, Output 80 A/204 W

EN/LZT 146 307 R3A Dec 2007

© Ericsson Power Modules AB

Key Features

- Industry standard quarter-brick and optional double Pin-Out. 57.9 x 36.8 x 9.1 mm (2.28 x 1.45 x 0.35 in.)
- High efficiency, typ. 94 % at 12 Vout half load
- 2250 Vdc input to output isolation
- Meets isolation requirements equivalent to basic insulation according to IEC/EN/UL 60950
- More than 2.7 million hours MTBF

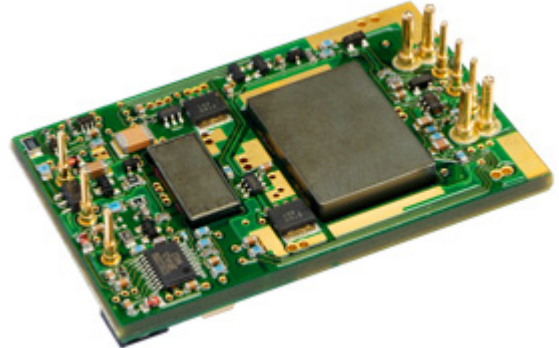

General Characteristics

- Over temperature protection
- Over current limit protection
- Over voltage protection
- Remote control
- Output voltage adjust function
- Highly automated manufacturing ensures quality
- ISO 9001/14001 certified supplier

Safety Approvals



Design for Environment



Meets requirements in high-temperature lead-free soldering processes.

Contents

General Information	2
Safety Specification	3
Absolute Maximum Ratings	4
Product Program	Ordering No.	
1.2V, 80A / 96W Electrical Specification	PKM4918LC PINB	5
2.5V, 55A / 137.5W Electrical Specification	PKM4119C PINB	8
3.3V, 50A / 165W Electrical Specification	PKM4110C PINB	11
5.0V, 40A / 200W Electrical Specification	PKM4211C PINB	14
12.0V, 17A / 204W Electrical Specification	PKM4213C PINBSP	17
EMC Specification	20
Operating Information	21
Thermal Consideration	22
Connections	23
Mechanical Information	24
Soldering Information	28
Delivery Information	28
Product Qualification Specification	29

PKM 4000C PINB series DC/DC converters, Input 36-75 V, Output 80 A/204 W	EN/LZT 146 307 R3A Dec 2007
	© Ericsson Power Modules AB

General Information

Ordering Information

See Contents for individual product ordering numbers.

Option	Suffix	Ordering No.
Baseplate		PKM 4110C PI
Single Pin*	SP	PKM 4211C PINBSP
Positive Remote Control Logic	P	PKM 4110C PIPNB
Increased stand-off height	M	PKM 4110C PINBM
Lead length 3.69 mm (0.145 in)	LA	PKM 4110C PINBLA
Lead length 4.57 mm (0.180 in)	LB	PKM 4110C PINBLB

Note: As an example a positive logic, increased standoff, short pin product would be PKM 4110C PIPNBMLA.

*Single Pin option only for current less than 50A.

Reliability

The Mean Time Between Failure (MTBF) is calculated at full output power and an operating ambient temperature (T_A) of +40°C, which is a typical condition in Information and Communication Technology (ICT) equipment. Different methods could be used to calculate the predicted MTBF and failure rate which may give different results. Ericsson Power Modules currently uses two different methods, Ericsson failure rate data system DependTool and Telcordia SR332.

Predicted MTBF for the series is:

- 2.7 million hours according to DependTool.
- 1.4 million hours according to Telcordia SR332, issue 1, Black box technique.

The Ericsson failure rate data system is based on field tracking data. The data corresponds to actual failure rates of components used in ICT equipment in temperature controlled environments ($T_A = -5...+65^\circ\text{C}$). Telcordia SR332 is a commonly used standard method intended for reliability calculations in ICT equipment. The parts count procedure used in this method was originally modelled on the methods from MIL-HDBK-217F, Reliability Predictions of Electronic Equipment. It assumes that no reliability data is available on the actual units and devices for which the predictions are to be made, i.e. all predictions are based on generic reliability parameters.

Compatibility with RoHS requirements

The products are compatible with the relevant clauses and requirements of the RoHS directive 2002/95/EC and have a maximum concentration value of 0.1% by weight in homogeneous materials for lead, mercury, hexavalent chromium, PBB and PBDE and of 0.01% by weight in homogeneous materials for cadmium.

Exemptions in the RoHS directive utilized in Ericsson Power Modules products include:

- Lead in high melting temperature type solder (used to solder the die in semiconductor packages)

- Lead in glass of electronics components and in electronic ceramic parts (e.g. fill material in chip resistors)
- Lead as an alloying element in copper alloy containing up to 4% lead by weight (used in connection pins made of Brass)

Quality Statement

The products are designed and manufactured in an industrial environment where quality systems and methods like ISO 9000, 6σ (sigma), and SPC are intensively in use to boost the continuous improvements strategy. Infant mortality or early failures in the products are screened out and they are subjected to an ATE-based final test. Conservative design rules, design reviews and product qualifications, plus the high competence of an engaged work force, contribute to the high quality of our products.

Warranty

Warranty period and conditions are defined in Ericsson Power Modules General Terms and Conditions of Sale.

Limitation of Liability

Ericsson power Modules does not make any other warranties, expressed or implied including any warranty of merchantability or fitness for a particular purpose (including, but not limited to, use in life support applications, where malfunctions of product can cause injury to a person's health or life).

PKM 4000C PINB series DC/DC converters, Input 36-75 V, Output 80 A/204 W	EN/LZT 146 307 R3A Dec 2007
	© Ericsson Power Modules AB

Safety Specification

General information

Ericsson Power Modules DC/DC converters and DC/DC regulators are designed in accordance with safety standards IEC/EN/UL60950, *Safety of Information Technology Equipment*.

IEC/EN/UL60950 contains requirements to prevent injury or damage due to the following hazards:

- Electrical shock
- Energy hazards
- Fire
- Mechanical and heat hazards
- Radiation hazards
- Chemical hazards

On-board DC-DC converters are defined as component power supplies. As components they cannot fully comply with the provisions of any Safety requirements without "Conditions of Acceptability". It is the responsibility of the installer to ensure that the final product housing these components complies with the requirements of all applicable Safety standards and Directives for the final product.

Component power supplies for general use should comply with the requirements in IEC60950, EN60950 and UL60950 "*Safety of information technology equipment*".

There are other more product related standards, e.g. IEEE802.3af "Ethernet LAN/MAN Data terminal equipment power", and ETS300132-2 "Power supply interface at the input to telecommunications equipment; part 2: DC", but all of these standards are based on IEC/EN/UL60950 with regards to safety.

Ericsson Power Modules DC/DC converters and DC/DC regulators are UL60950 recognized and certified in accordance with EN60950.

The flammability rating for all construction parts of the products meets requirements for V-0 class material according to IEC 60695-11-10.

The products should be installed in the end-use equipment, in accordance with the requirements of the ultimate application. Normally the output of the DC/DC converter is considered as SELV (Safety Extra Low Voltage) and the input source must be isolated by minimum Double or Reinforced Insulation from the primary circuit (AC mains) in accordance with IEC/EN/UL60950.

Isolated DC/DC converters

It is recommended that a slow blow fuse with a rating twice the maximum input current per selected product be used at the input of each DC/DC converter. If an input filter is used in the circuit the fuse should be placed in front of the input filter.

In the rare event of a component problem in the input filter or in the DC/DC converter that imposes a short circuit on the input source, this fuse will provide the following functions:

- Isolate the faulty DC/DC converter from the input power source so as not to affect the operation of other parts of the system.
- Protect the distribution wiring from excessive current and power loss thus preventing hazardous overheating.

The galvanic isolation is verified in an electric strength test. The test voltage (V_{iso}) between input and output is 1500 Vdc or 2250 Vdc for 60 seconds (refer to product specification).

Leakage current is less than 1 μ A at nominal input voltage.

24 V DC systems

The input voltage to the DC/DC converter is SELV (Safety Extra Low Voltage) and the output remains SELV under normal and abnormal operating conditions.

48 and 60 V DC systems

If the input voltage to Ericsson Power Modules DC/DC converter is 75 Vdc or less, then the output remains SELV (Safety Extra Low Voltage) under normal and abnormal operating conditions.

Single fault testing in the input power supply circuit should be performed with the DC/DC converter connected to demonstrate that the input voltage does not exceed 75 Vdc.

If the input power source circuit is a DC power system, the source may be treated as a TNV2 circuit and testing has demonstrated compliance with SELV limits and isolation requirements equivalent to Basic Insulation in accordance with IEC/EN/UL60950.

Non-isolated DC/DC regulators

The input voltage to the DC/DC regulator is SELV (Safety Extra Low Voltage) and the output remains SELV under normal and abnormal operating conditions.

PKM 4000C PINB series
DC/DC converters, Input 36-75 V, Output 80 A/204 W

EN/LZT 146 307 R3A Dec 2007

© Ericsson Power Modules AB

Absolute Maximum Ratings

Characteristics		min	typ	max	Unit
T_{ref}	Operating Temperature (see Thermal Consideration section)	-40		+110	°C
T_S	Storage temperature	-55		+125	°C
V_I	Input voltage	-0.5		+80	V
V_{iso}	Isolation voltage baseplate (input to output, input & output to baseplate test voltage)			2250	Vdc
V_{iso}	Isolation voltage no baseplate option (input to output)			1500	Vdc
V_{tr}	Input voltage transient (Tp 100 ms)			100	V
V_{RC}	Remote Control pin voltage (see Operating Information section)	Positive logic option		+15	V
		Negative logic		+15	V
V_{adj}	Adjust pin voltage (see Operating Information section)	-0.5		+2	V

Stress in excess of Absolute Maximum Ratings may cause permanent damage. Absolute Maximum Ratings, sometimes referred to as no destruction limits, are normally tested with one parameter at a time exceeding the limits of Output data or Electrical Characteristics. If exposed to stress above these limits, function and performance may degrade in an unspecified manner.

Fundamental Circuit Diagram

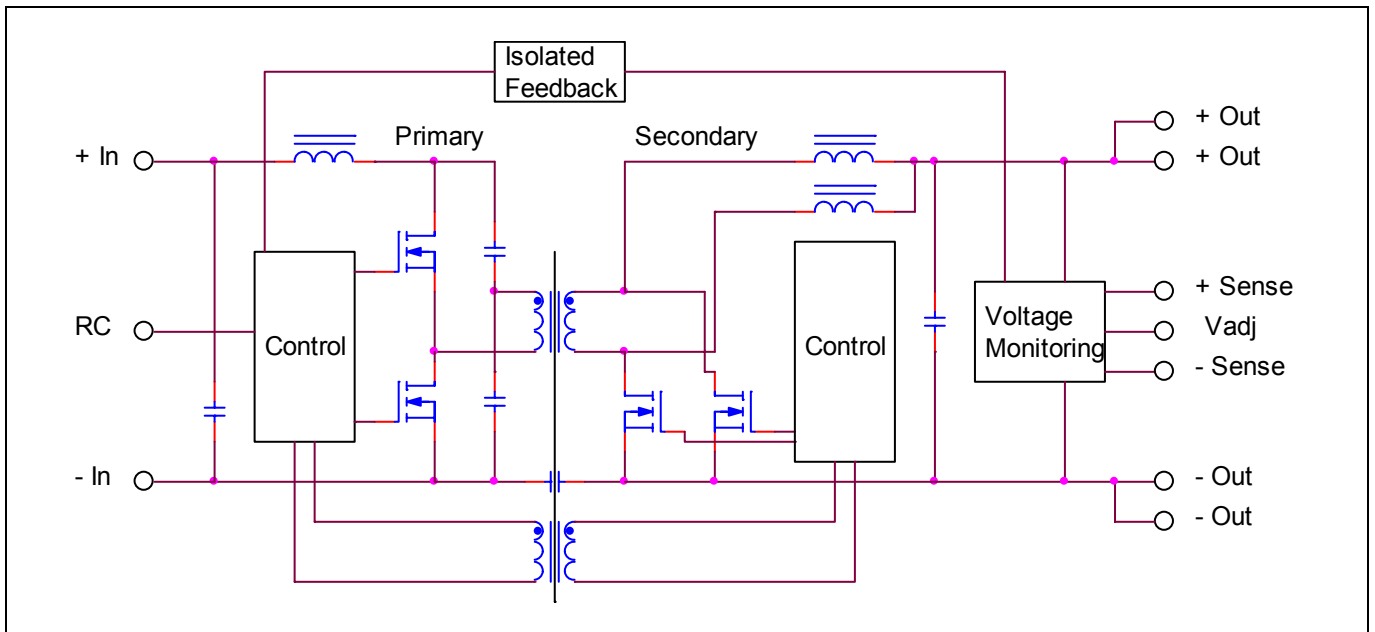

PKM 4000C PINB series DC/DC converters, Input 36-75 V, Output 80 A/204 W	EN/LZT 146 307 R3A Dec 2007
	© Ericsson Power Modules AB

1.2 V Electrical Specification
PKM 4918LC PINB
 $T_{ref} = -40$ to $+90^{\circ}\text{C}$, $V_I = 36$ to 75 V, unless otherwise specified under Conditions.

 Typical values given at: $T_{ref} = +25^{\circ}\text{C}$, $V_I = 53$ V, max I_O , unless otherwise specified under Conditions.

Characteristics		Conditions	min	typ	max	Unit
V_I	Input voltage range		36		75	V
V_{loff}	Turn-off input voltage	Decreasing input voltage		32		V
V_{lon}	Turn-on input voltage	Increasing input voltage		34		V
C_I	Internal input capacitance			4.3		μF
P_O	Output power	Output voltage initial setting	0		96	W
SVR	Supply voltage rejection (ac)	$f = 100$ Hz sinewave, 1 Vp-p		70		dB
η	Efficiency	50 % of max I_O		87.7		%
		max I_O , $V_I = 53$ V, $T_{ref} = +25^{\circ}\text{C}$	81	82.4		
		50 % of max I_O , $V_I = 48$ V		88.0		
		max I_O , $V_I = 48$ V		82.1		
P_d	Power Dissipation	max I_O , $V_I = 53$ V, $T_{ref} = +25^{\circ}\text{C}$			22.6	W
P_{li}	Input idling power	$I_O = 0$, $V_I = 53$ V		1.8		W
P_{RC}	Input standby power	$V_I = 53$ V (turned off with RC)		100		mW
f_s	Switching frequency	0 -100% of max I_O	145	155	165	kHz

V_{oi}	Output voltage initial setting and accuracy	$T_{ref} = +25^{\circ}\text{C}$, $V_I = 53$ V, $I_O = \text{max } I_O$ Vadj, see Note 1	1.18	1.20	1.22	V
	Output adjust range		0.96		1.32	V
V_O	Output voltage tolerance band	10-100% of max I_O	1.16		1.24	V
	Idling voltage	$I_O = 0$	1.18		1.22	V
	Line regulation	max I_O			25	mV
	Load regulation	$V_I = 53$ V, 1-100% of max I_O			15	mV
V_{tr}	Load transient voltage deviation	$V_I = 53$ V, Load step 25-75-25 % of max I_O , $di/dt = 1$ A/ μs , see Note 2	± 300			mV
t_{tr}	Load transient recovery time		100			μs
t_r	Ramp-up time (from 10-90 % of V_O)	10-100% of max I_O	5	10	15	ms
t_s	Start-up time (from V_I connection to 90% of V_O)		8	15	50	ms
I_O	Output current		0		80	A
I_{lim}	Current limit threshold	$V_O = 1.08$ V, $T_{ref} < \text{max } T_{ref}$		93		A
I_{sc}	Short circuit current	$T_{ref} = 25^{\circ}\text{C}$, $V_O = < V_{Onom} * 0.1$		102		A
V_{Oac}	Output ripple & noise	See ripple & noise section, max I_O , V_O .		100	200	mVp-p

 Note 1: When using Vadj function, max output power (P_O) must not be exceeded

Note 2: Output filter according to Ripple & Noise section

PKM 4000C PINB series
DC/DC converters, Input 36-75 V, Output 80 A/204 W

EN/LZT 146 307 R3A Dec 2007

© Ericsson Power Modules AB

1.2 V Typical Characteristics

PKM 4918LC PINB

Efficiency

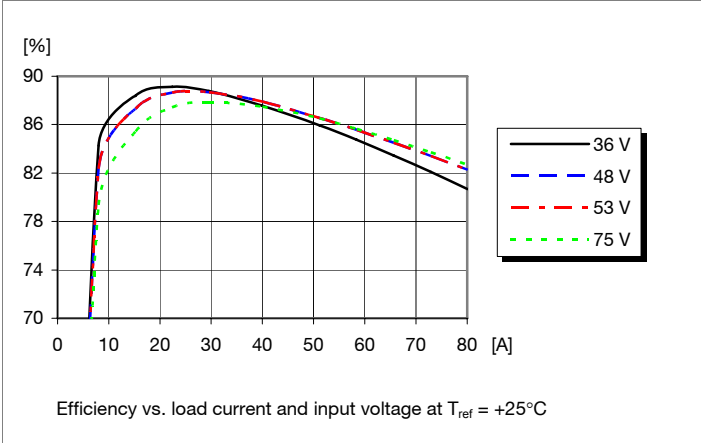

Power Dissipation

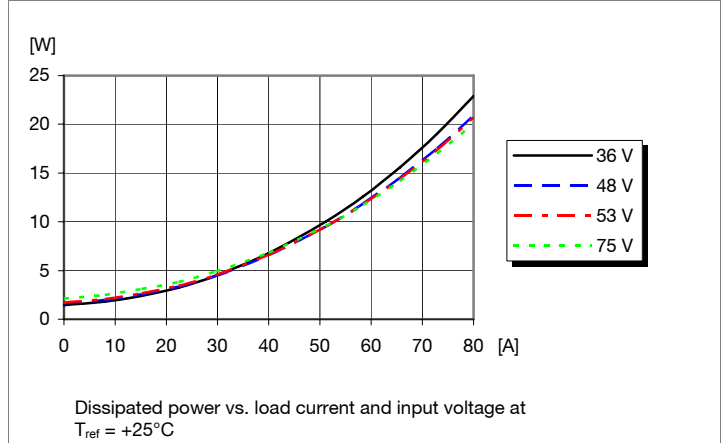

Output Current Derating

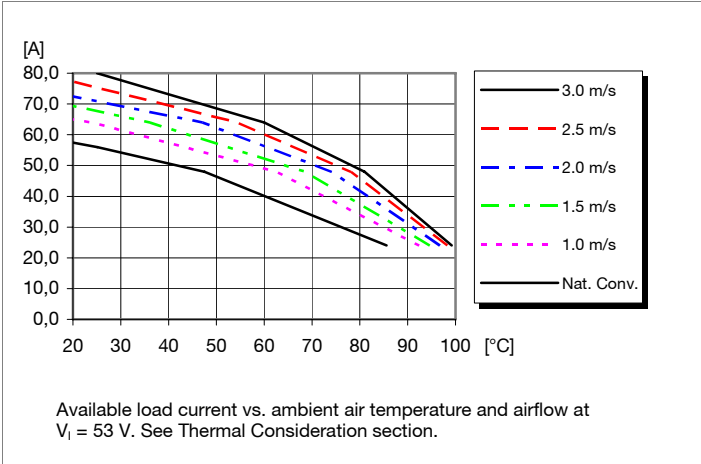

Thermal Resistance

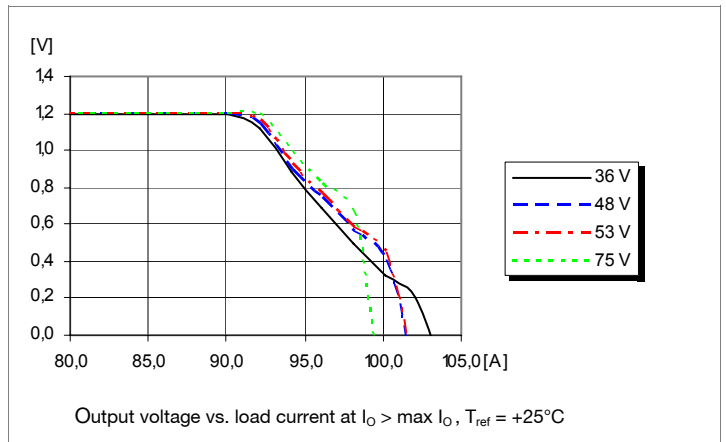
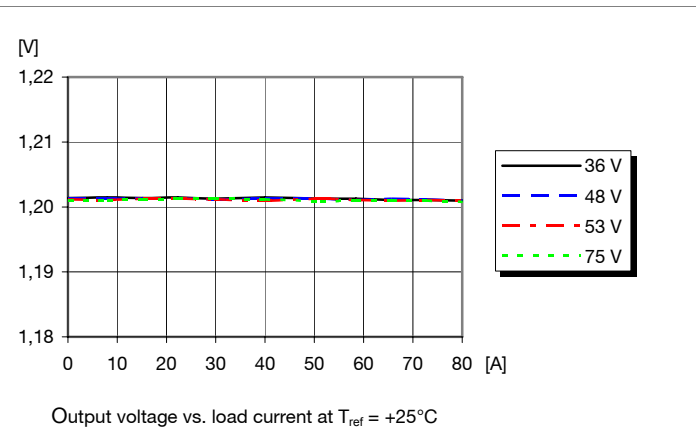
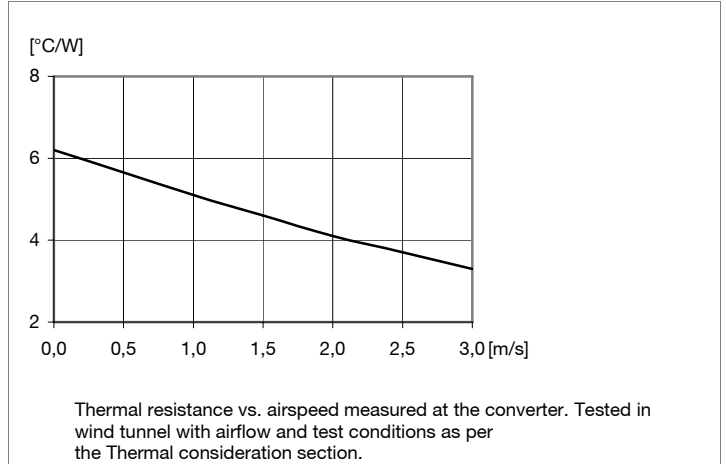

PKM 4000C PINB series
DC/DC converters, Input 36-75 V, Output 80 A/204 W

EN/LZT 146 307 R3A Dec 2007

© Ericsson Power Modules AB

1.2 V Typical Characteristics

PKM 4918LC PINB

Start-up

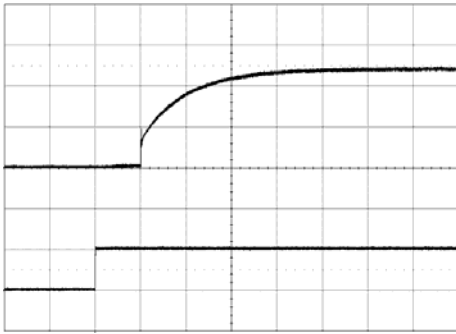

Start-up enabled by connecting V_i at:
 $T_{ref} = +25^{\circ}C$, $I_o = 80$ A resistive load,
 $V_i = 53$ V.

Top trace: output voltage (0.5 V/div.),
Bottom trace: input voltage (20 V/div.).
Time scale: 5 ms/div..

Shut-down

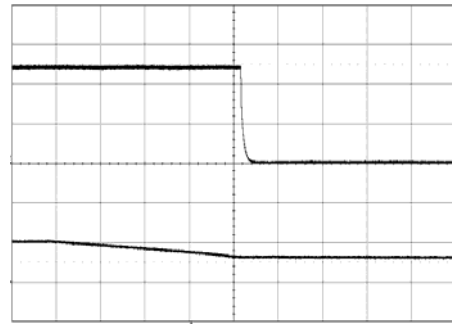

Shut-down enabled by disconnecting V_i at:
 $T_{ref} = +25^{\circ}C$, $I_o = 8$ A resistive load,
 $V_i = 53$ V

Top trace: output voltage (0.5 V/div.),
Bottom trace: input voltage (20 V/div.).
Time scale: 0.1 ms/div..

Output Ripple & Noise

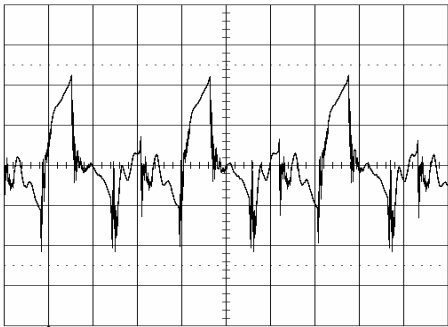

Output voltage ripple (20mV/div.) at:
 $T_{ref} = +25^{\circ}C$, $I_o = 80$ A resistive load,
 $V_i = 53$ V). Time scale: 2 μ s/div.

See the filter in the Output ripple and noise section (EMC Specification).

Output Load Transient Response

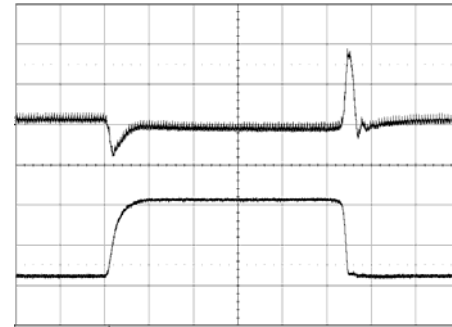

Output voltage response to load current step-change (20-60-20 A) at:
 $T_{ref} = +25^{\circ}C$, $V_i = 53$ V.

Top trace: output voltage (200mV/div.),
Bottom trace: load current (20 A/div.).
Time scale: {0.1 ms/div.}

Output Voltage Adjust (see operating information)

Passive trim

The resistor value for an adjusted output voltage is calculated by using the following equations:

Output Voltage Adjust Upwards, Increase:
 $R_{adj} = [4896 / (1.0208 - (1.225/V_o))] - 1000$ Ohm

Eg Increase 4% => $V_{out} = 1.248$ Vdc
 $4896 / (1.0208 - (1.225/1.62)) - 1000 = 124$ kOhm

Output Voltage Adjust Downwards, Decrease:
 $R_{adj} = [5104 / ((1.225/V_o) - 1.0208)] - 1000$ Ohm

Eg Decrease 2% => $V_{out} = 1.176$ Vdc
 $5104 / ((1.225/1.1176) - 1.0208) - 1000 = 66.8$ kOhm

The PKM4000C series DC/DC converters can be offered with a baseplate. Baseplate helps to cool hotspots more efficient during heavy load. The baseplate have approximately 5°C improved derating compared to datasheet showing non baseplated PKM4000C. The baseplate is intended to be mounted on a cold wall to transfer heat away from the converter. By mounting PKM4000C in this way thermal derating can be improved by more than 10°C .

PKM 4000C PINB series
 DC/DC converters, Input 36-75 V, Output 80 A/204 W

EN/LZT 146 307 R3A Dec 2007

© Ericsson Power Modules AB

2.5 V Electrical Specification
PKM 4119C PINB
 $T_{ref} = -40$ to $+90^{\circ}\text{C}$, $V_I = 36$ to 75 V, unless otherwise specified under Conditions.

 Typical values given at: $T_{ref} = +25^{\circ}\text{C}$, $V_I = 53$ V, max I_O , unless otherwise specified under Conditions.

Characteristics		Conditions	min	typ	max	Unit
V_I	Input voltage range		36		75	V
V_{loff}	Turn-off input voltage	Decreasing input voltage		32		V
V_{lon}	Turn-on input voltage	Increasing input voltage		34		V
C_I	Internal input capacitance			5.7		μF
P_O	Output power	Output voltage initial setting	0		137.5	W
SVR	Supply voltage rejection (ac)	$f = 100$ Hz sinewave, 1 Vp-p		55		dB
η	Efficiency	50 % of max I_O		91.5		%
		max I_O	88	89.2		
		50 % of max I_O , $V_I = 48$ V		91.7		
		max I_O , $V_I = 48$ V		88.9		
P_d	Power Dissipation	max I_O			18.8	W
P_{ii}	Input idling power	$I_O = 0$, $V_I = 53$ V		2.6		W
P_{RC}	Input standby power	$V_I = 53$ V (turned off with RC)		100		mW
f_s	Switching frequency	0 -100% of max I_O	180	200	220	kHz

V_{oi}	Output voltage initial setting and accuracy	$T_{ref} = +25^{\circ}\text{C}$, $V_I = 53$ V, $I_O = \text{max } I_O$ Vadj, see Note 1	2.45	2.50	2.55	V
	Output adjust range		2.21		2.81	V
V_O	Output voltage tolerance band	10-100% of max I_O	2.40		2.60	V
	Idling voltage	$I_O = 0$	2.40		2.60	V
	Line regulation	max I_O			15	mV
	Load regulation	$V_I = 53$ V, 1-100% of max I_O			15	mV
V_{tr}	Load transient voltage deviation	$V_I = 53$ V, Load step 25-75-25 % of max I_O , $di/dt = 1$ A/ μs , see Note 2	± 250			mV
t_{tr}	Load transient recovery time		100			μs
t_r	Ramp-up time (from 10-90 % of V_O)	10-100% of max I_O	5	10	15	ms
t_s	Start-up time (from V_I connection to 90% of V_O)		10	15	50	ms
I_O	Output current		0		55	A
I_{lim}	Current limit threshold	$V_O = 2.25$ V, $T_{ref} < \text{max } T_{ref}$		63		A
I_{sc}	Short circuit current	$T_{ref} = 25^{\circ}\text{C}$,		74		A
V_{Oac}	Output ripple & noise	See ripple & noise section, max I_O , V_O .		80	130	mVp-p
OVP	Over Voltage Protection	$T_{ref} = +25^{\circ}\text{C}$, $V_I = 53$ V, $I_O = 0$ -100% of max I_O		3.4		V

 Note 1: When using Vadj function, max output power (P_O) must not be exceeded

Note 2: Output filter according to Ripple & Noise section

PKM 4000C PINB series
DC/DC converters, Input 36-75 V, Output 80 A/204 W

EN/LZT 146 307 R3A Dec 2007

© Ericsson Power Modules AB

2.5 V Typical Characteristics

PKM 4119C PINB

Efficiency

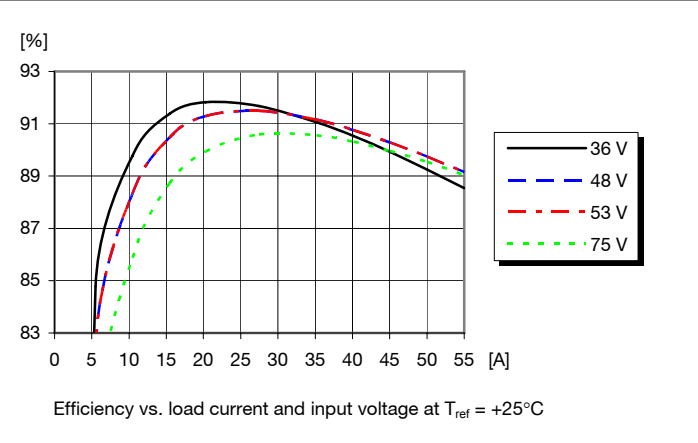

Power Dissipation

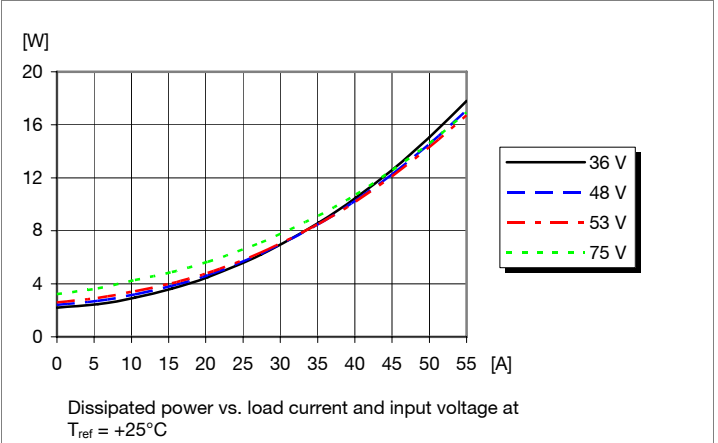

Output Current Derating

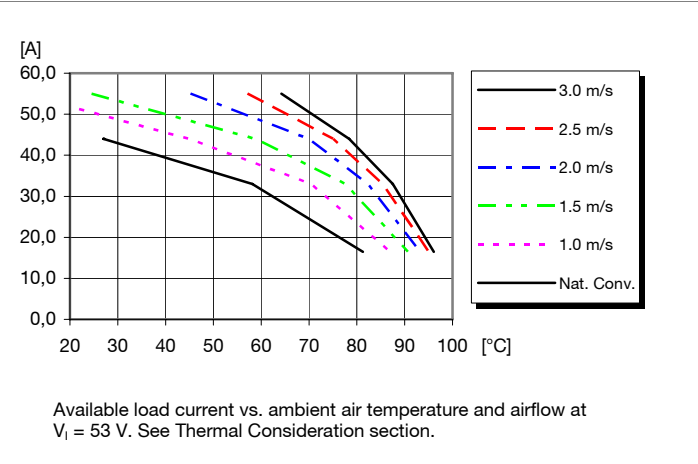

Thermal Resistance

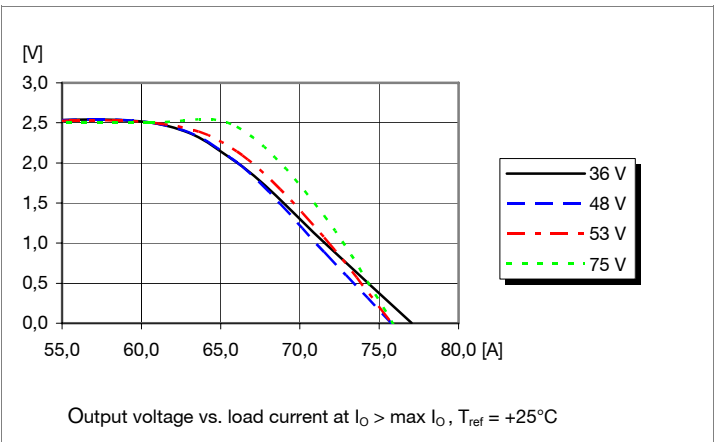
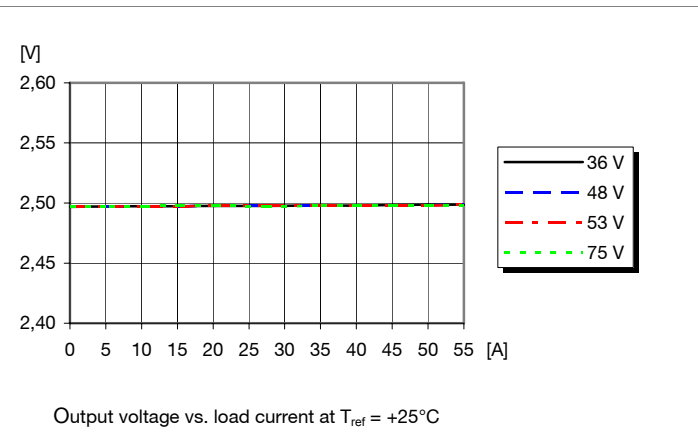
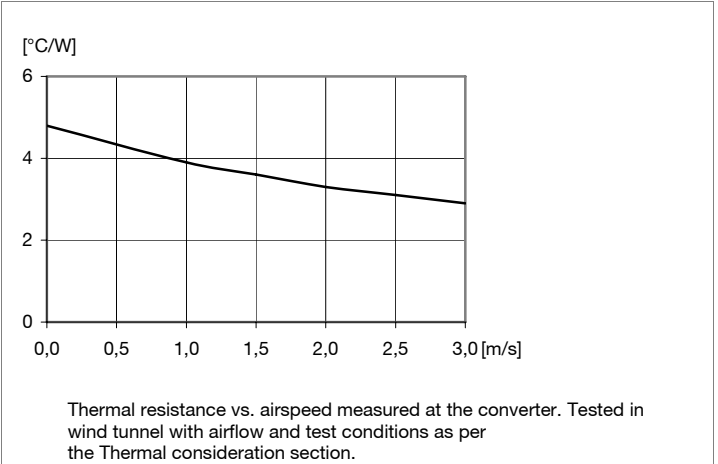

PKM 4000C PINB series
DC/DC converters, Input 36-75 V, Output 80 A/204 W

EN/LZT 146 307 R3A Dec 2007

© Ericsson Power Modules AB

2.5 V Typical Characteristics

PKM 4119C PINB

Start-up

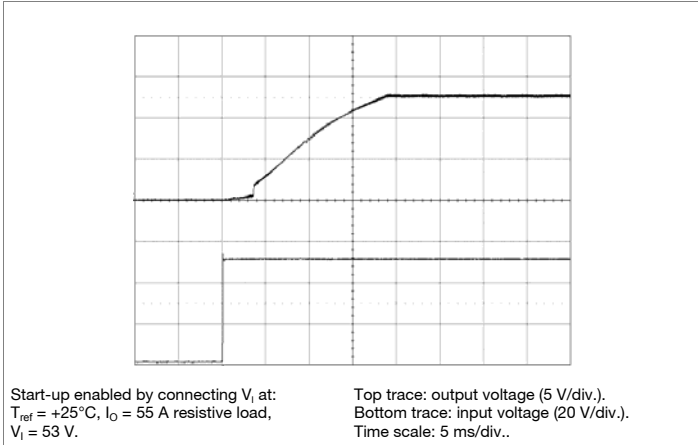

Shut-down

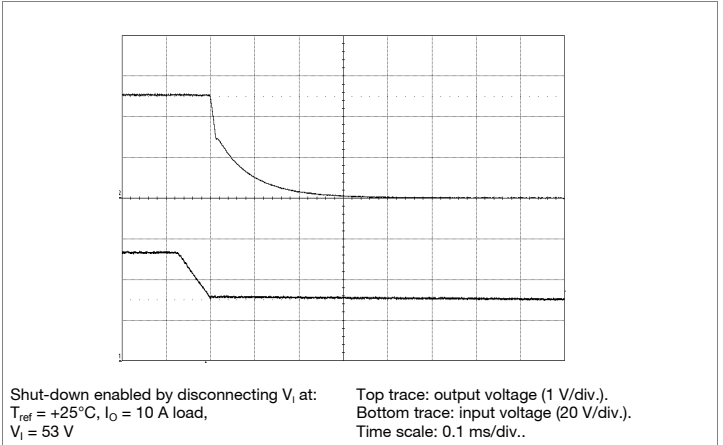

Output Ripple & Noise

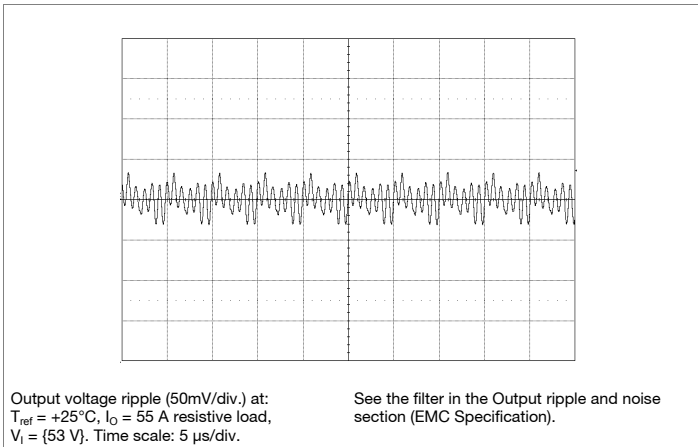

Output Load Transient Response

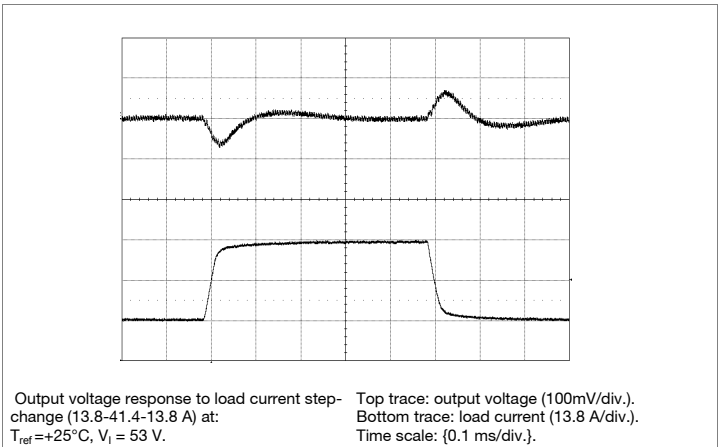

Output Voltage Adjust (see operating information)

Passive trim

The resistor value for an adjusted output voltage is calculated by using the following equations:

Output Voltage Adjust Upwards, Increase:

$$R_{adj} = 5.11((2.5(100+\Delta\%))/1.225\Delta\% - (100+2\Delta\%)/\Delta\%) \text{ kOhm}$$

Eg Increase 4% => $V_{out} = 2.6\text{ Vdc}$

$$5.11(2.5(100+4)/1.225 \times 4 - (100+2 \times 4)/4) = 133 \text{ kOhm}$$

Output Voltage Adjust Downwards, Decrease:

$$R_{adj} = 5.11(100/\Delta\% - 2) \text{ kOhm}$$

Eg Decrease 2% => $V_{out} = 2.45\text{ Vdc}$

$$5.11(100/2 - 2) = 245 \text{ kOhm}$$

The PKM4000C series DC/DC converters can be offered with a baseplate. Baseplate helps to cool hotspots more efficient during heavy load. The baseplate have approximately 5°C improved derating compared to datasheet showing non baseplated PKM4000C. The baseplate is intended to be mounted on a cold wall to transfer heat away from the converter. By mounting PKM4000C in this way thermal derating can be improved by more than 10°C .

PKM 4000C PINB series
 DC/DC converters, Input 36-75 V, Output 80 A/204 W

EN/LZT 146 307 R3A Dec 2007

© Ericsson Power Modules AB

3.3 V Electrical Specification
PKM 4110C PINB
 $T_{ref} = -40$ to $+90^{\circ}\text{C}$, $V_I = 36$ to 75 V, unless otherwise specified under Conditions.

 Typical values given at: $T_{ref} = +25^{\circ}\text{C}$, $V_I = 53$ V, max I_O , unless otherwise specified under Conditions.

Characteristics		Conditions	min	typ	max	Unit
V_I	Input voltage range		36		75	V
V_{loff}	Turn-off input voltage	Decreasing input voltage		32		V
V_{lon}	Turn-on input voltage	Increasing input voltage		34		V
C_I	Internal input capacitance			5.7		μF
P_O	Output power	Output voltage initial setting	0		165	W
SVR	Supply voltage rejection (ac)	$f = 100$ Hz sinewave, 1 Vp-p		50		dB
η	Efficiency	50 % of max I_O		92.2		%
		max I_O	89	90.3		
		50 % of max I_O , $V_I = 48$ V		92.3		
		max I_O , $V_I = 48$ V		90.1		
P_d	Power Dissipation	max I_O			20.4	W
P_{ii}	Input idling power	$I_O = 0$, $V_I = 53$ V		3.4		W
P_{RC}	Input standby power	$V_I = 53$ V (turned off with RC)		100		mW
f_s	Switching frequency	0 -100% of max I_O	145	155	165	kHz

V_{oi}	Output voltage initial setting and accuracy	$T_{ref} = +25^{\circ}\text{C}$, $V_I = 53$ V, $I_O = \text{max } I_O$ Vadj, see Note 1	3.24		3.36	V
	Output adjust range		2.97		3.63	V
V_O	Output voltage tolerance band	10-100% of max I_O	3.23		3.37	V
	Idling voltage	$I_O = 0$	3.23		3.37	V
	Line regulation	max I_O			15	mV
	Load regulation	$V_I = 53$ V, 1-100% of max I_O			15	mV
V_{tr}	Load transient voltage deviation	$V_I = 53$ V, Load step 25-75-25 % of max I_O , $di/dt = 1$ A/ μs , see Note 2	± 500			mV
t_{tr}	Load transient recovery time		100			μs
t_r	Ramp-up time (from 10–90 % of V_O)	10-100% of max I_O	7	10	30	ms
t_s	Start-up time (from V_I connection to 90% of V_O)		10	15	50	ms
I_O	Output current		0		50	A
I_{lim}	Current limit threshold	$V_O = 2.97$ V, $T_{ref} < \text{max } T_{ref}$		61		A
I_{sc}	Short circuit current	$T_{ref} = 25^{\circ}\text{C}$, $V_O = < V_{Onom} * 0.1$		65		A
V_{Oac}	Output ripple & noise	See ripple & noise section, max I_O , V_O .		60	125	mVp-p
OVP	Over Voltage Protection	$T_{ref} = +25^{\circ}\text{C}$, $V_I = 53$ V, $I_O = 0$ -100% of max I_O		4.2		V

 Note 1: When using Vadj function, max output power (P_O) must not be exceeded

Note 2: Output filter according to Ripple & Noise section

PKM 4000C PINB series
DC/DC converters, Input 36-75 V, Output 80 A/204 W

EN/LZT 146 307 R3A Dec 2007

© Ericsson Power Modules AB

3.3 V Typical Characteristics

PKM 4110C PINB

Efficiency

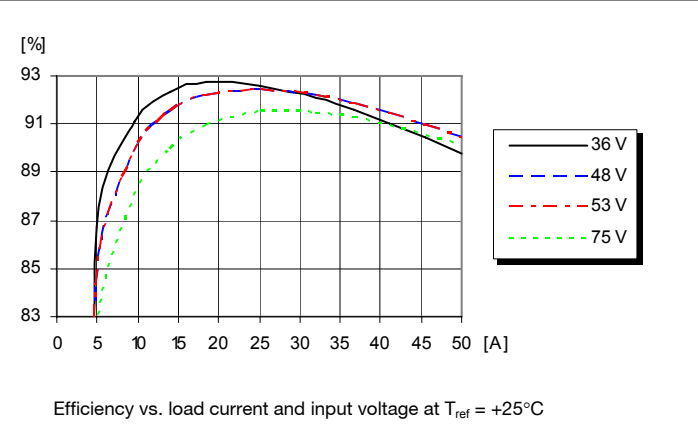

Power Dissipation

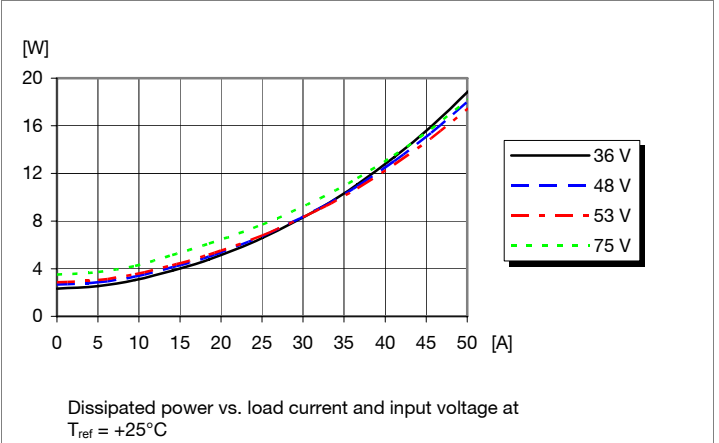

Output Current Derating

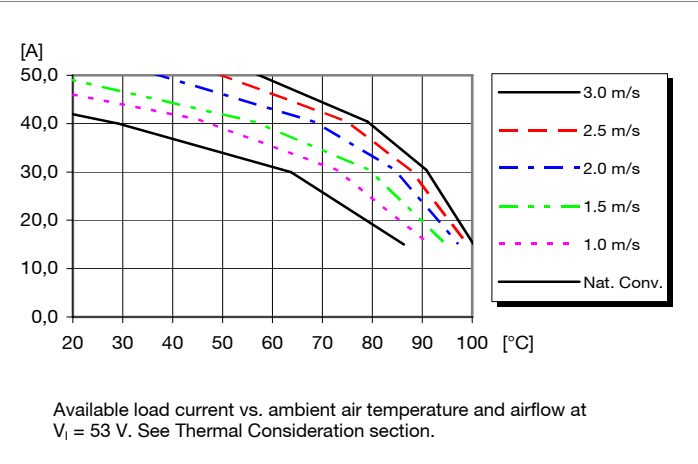

Thermal Resistance

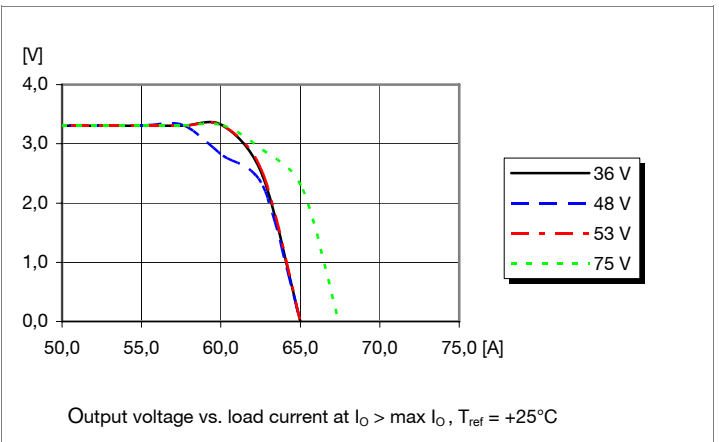
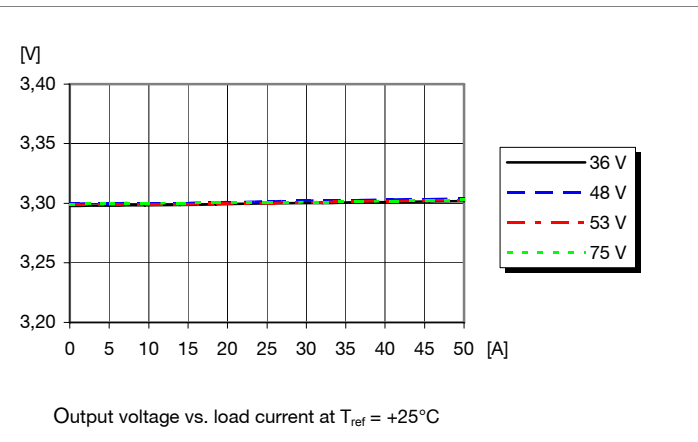
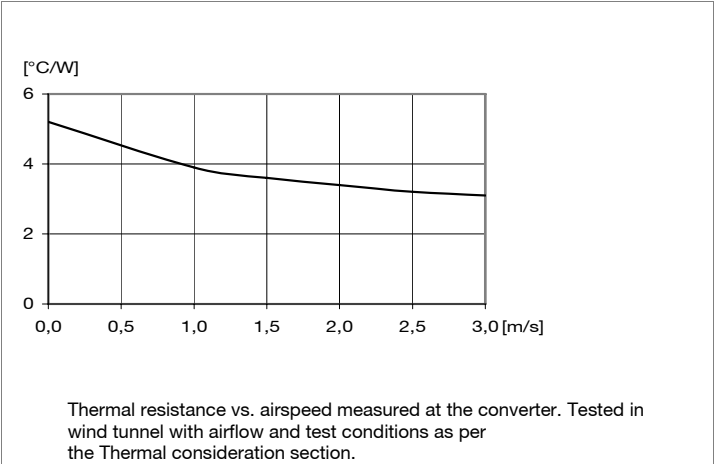

PKM 4000C PINB series
DC/DC converters, Input 36-75 V, Output 80 A/204 W

EN/LZT 146 307 R3A Dec 2007

© Ericsson Power Modules AB

3.3 V Typical Characteristics

PKM 4110C PINB

Start-up

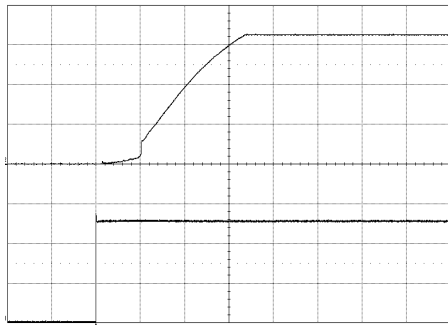

Start-up enabled by connecting V_i at:
 $T_{ref} = +25^{\circ}C$, $I_o = 50$ A resistive load,
 $V_i = 53$ V.
Top trace: output voltage (1 V/div.).
Bottom trace: input voltage (20 V/div.).
Time scale: 5 ms/div..

Shut-down

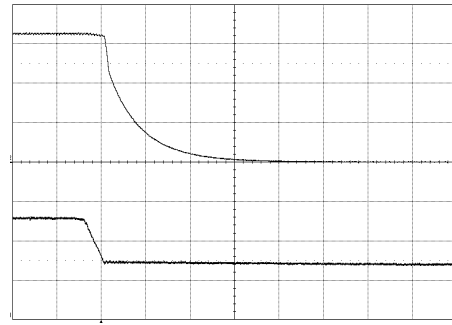

Shut-down enabled by disconnecting V_i at:
 $T_{ref} = +25^{\circ}C$, $I_o = 10$ A load,
 $V_i = 53$ V.
Top trace: output voltage (1 V/div.).
Bottom trace: input voltage (20 V/div.).
Time scale: 0.1 ms/div..

Output Ripple & Noise

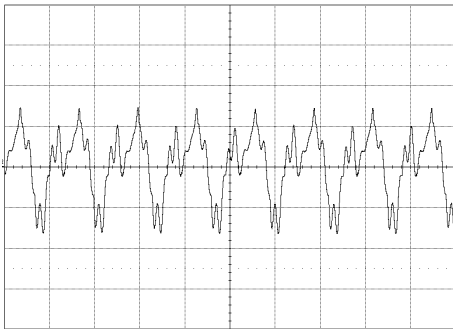

Output voltage ripple (20mV/div.) at:
 $T_{ref} = +25^{\circ}C$, $I_o = 50$ A resistive load,
 $V_i = 53$ V. Time scale: 5 μ s/div.
See the filter in the Output ripple and noise section (EMC Specification).

Output Load Transient Response

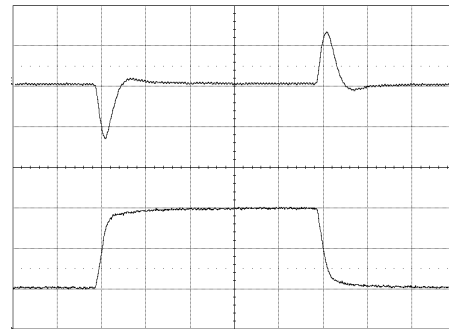

Output voltage response to load current step-change (12.5-47.5-12.5 A) at:
 $T_{ref} = +25^{\circ}C$, $V_i = 53$ V.
Top trace: output voltage (200mV/div.).
Bottom trace: load current (12.5 A/div.).
Time scale: {0.1 ms/div.}.

Output Voltage Adjust (see operating information)

Passive trim

The resistor value for an adjusted output voltage is calculated by using the following equations:

Output Voltage Adjust Upwards, Increase:
 $R_{adj} = 5.11((3.3(100+\Delta\%))/1.225\Delta\% - (100+2\Delta\%)/\Delta\%)$ kOhm

Eg Increase 4% => $V_{out} = 3.43$ Vdc
 $5.11(3.3(100+4)/1.225 \times 4 - (100+2 \times 4)/4) = 220$ kOhm

Output Voltage Adjust Downwards, Decrease:
 $R_{adj} = 5.11(100/\Delta\% - 2)$ kOhm

Eg Decrease 2% => $V_{out} = 3.23$ Vdc
 $5.11(100/2 - 2) = 245$ kOhm

The PKM4000C series DC/DC converters can be offered with a baseplate. Baseplate helps to cool hotspots more efficient during heavy load. The baseplate have approximately 5°C improved derating compared to datasheet showing non baseplated PKM4000C. The baseplate is intended to be mounted on a cold wall to transfer heat away from the converter. By mounting PKM4000C in this way thermal derating can be improved by more than 10°C .

PKM 4000C PINB series
 DC/DC converters, Input 36-75 V, Output 80 A/204 W

EN/LZT 146 307 R3A Dec 2007

© Ericsson Power Modules AB

5.0 V Electrical Specification
PKM 4211C PINB
 $T_{ref} = -40$ to $+90^{\circ}\text{C}$, $V_I = 36$ to 75 V, unless otherwise specified under Conditions.

 Typical values given at: $T_{ref} = +25^{\circ}\text{C}$, $V_I = 53$ V, max I_O , unless otherwise specified under Conditions.

Characteristics		Conditions	min	typ	max	Unit
V_I	Input voltage range		36		75	V
V_{loff}	Turn-off input voltage	Decreasing input voltage		32		V
V_{lon}	Turn-on input voltage	Increasing input voltage		34		V
C_I	Internal input capacitance			5.7		μF
P_O	Output power	Output voltage initial setting	0		200	W
SVR	Supply voltage rejection (ac)	$f = 100$ Hz sinewave, 1 Vp-p		70		dB
η	Efficiency	50 % of max I_O		92.9		%
		max I_O	90	91.3		
		50 % of max I_O , $V_I = 48$ V		93.0		
		max I_O , $V_I = 48$ V		91.2		
P_d	Power Dissipation	max I_O			22.2	W
P_{li}	Input idling power	$I_O = 0$, $V_I = 53$ V		3.1		W
P_{RC}	Input standby power	$V_I = 53$ V (turned off with RC)		100		mW
f_s	Switching frequency	0 -100% of max I_O	180	200	220	kHz

V_{O_i}	Output voltage initial setting and accuracy	$T_{ref} = +25^{\circ}\text{C}$, $V_I = 53$ V, $I_O = 40.0$ A Vadj, see Note 1	4.90	5.00	5.10	V
	Output adjust range		4.50		5.50	V
V_O	Output voltage tolerance band	10-100% of max I_O	4.80		5.20	V
	Idling voltage	$I_O = 0$	4.80		5.20	V
	Line regulation	max I_O			35	mV
	Load regulation	$V_I = 53$ V, 1-100% of max I_O			35	mV
V_{tr}	Load transient voltage deviation	$V_I = 53$ V, Load step 25-75-25 % of max I_O , $di/dt = 1$ A/ μs , see Note 2		± 700		mV
t_{tr}	Load transient recovery time			100		Us
t_r	Ramp-up time (from 10-90 % of V_O)	10-100% of max I_O	7	13	30	ms
t_s	Start-up time (from V_I connection to 90% of V_O)		9	15	50	ms
I_O	Output current		0		40	A
I_{lim}	Current limit threshold	$V_O = 4.5$ V, $T_{ref} < \max T_{ref}$		54		A
I_{sc}	Short circuit current	$T_{ref} = 25^{\circ}\text{C}$, $V_O = < V_{Onom} * 0.1$		67		A
V_{Oac}	Output ripple & noise	See ripple & noise section, max I_O , V_O .		60	150	mVp-p
OVP	Over Voltage Protection	$T_{ref} = +25^{\circ}\text{C}$, $V_I = 53$ V, $I_O = 0$ -100% of max I_O		6.2		V

 Note 1: When using Vadj function, max output power (P_O) must not be exceeded

Note 2: Output filter according to Ripple & Noise section

PKM 4000C PINB series
DC/DC converters, Input 36-75 V, Output 80 A/204 W

EN/LZT 146 307 R3A Dec 2007

© Ericsson Power Modules AB

5.0 V Typical Characteristics

PKM 4211C PINB

Efficiency

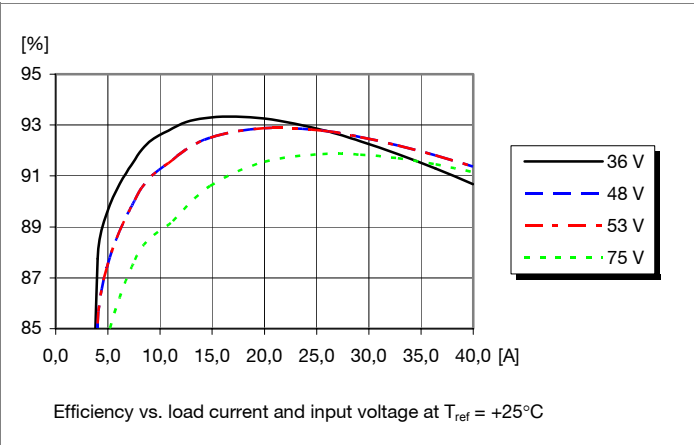

Power Dissipation

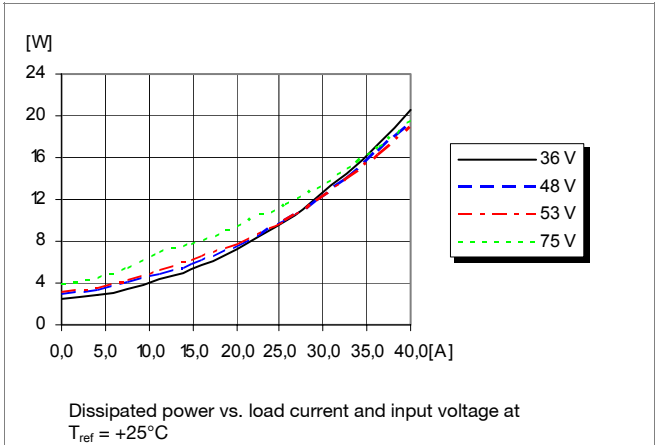

Output Current Derating

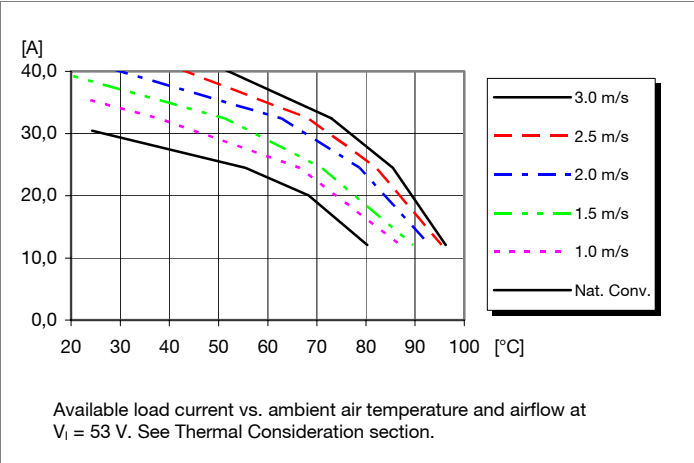

Thermal Resistance

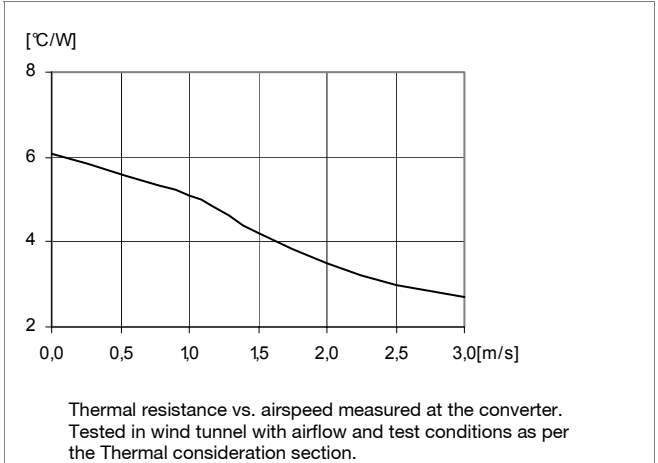

Output Characteristics

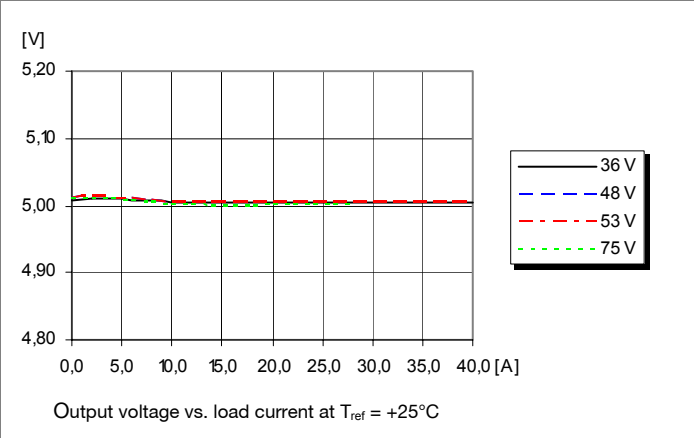

Current Limit Characteristics

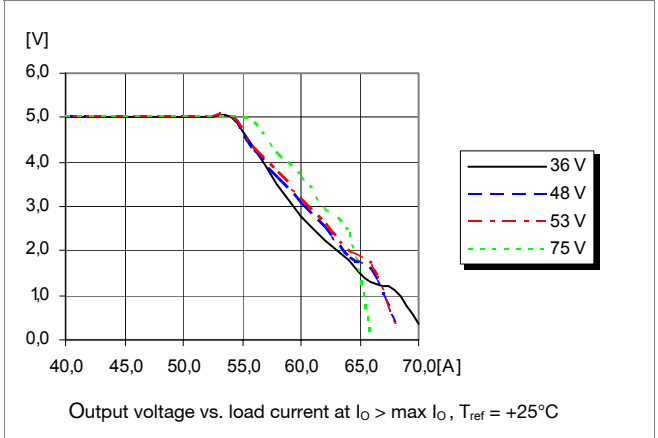

PKM 4000C PINB series
DC/DC converters, Input 36-75 V, Output 80 A/204 W

EN/LZT 146 307 R3A Dec 2007

© Ericsson Power Modules AB

5.0 V Typical Characteristics

PKM 4211C PINB

Start-up

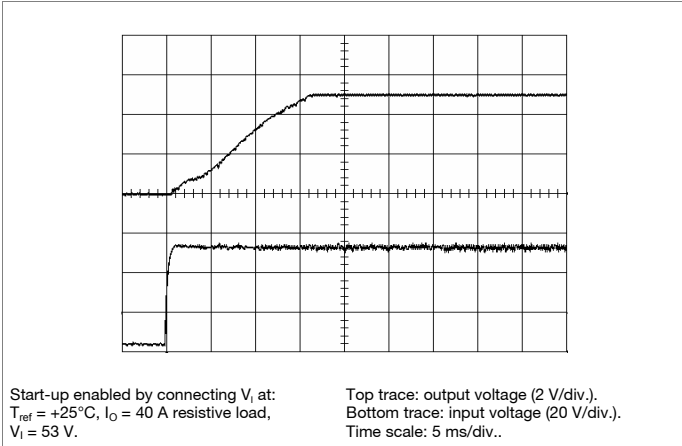

Shut-down

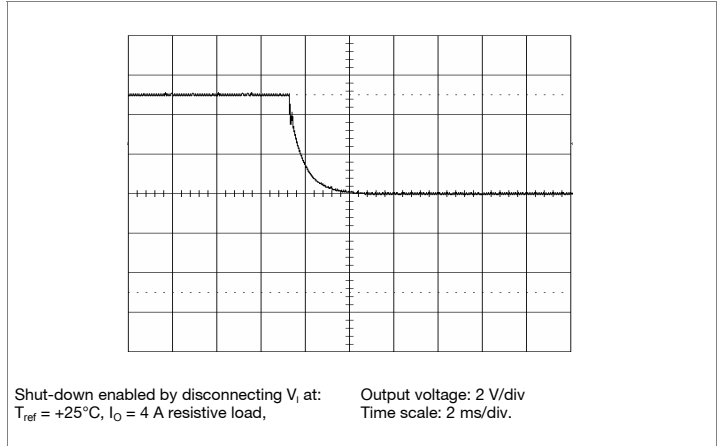

Output Ripple & Noise

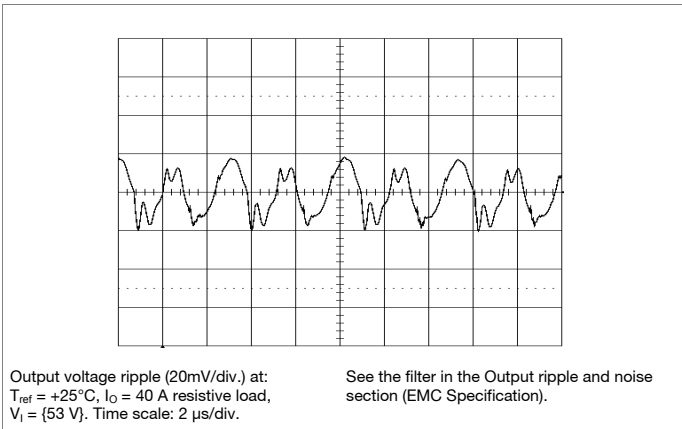

Output Load Transient Response

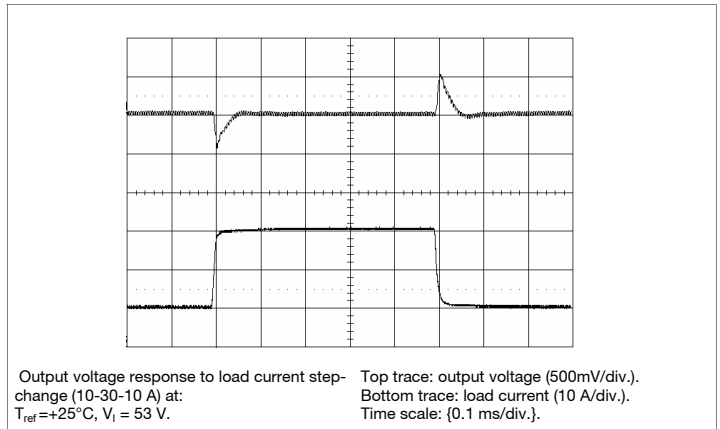

Output Voltage Adjust (see operating information)

Passive trim

The resistor value for an adjusted output voltage is calculated by using the following equations:

Output Voltage Adjust Upwards, Increase:

$$R_{adj} = 5.11((5(100+\Delta\%))/1.225\Delta\% - (100+2\Delta\%)/\Delta\%) \text{ k}\Omega$$

Eg Increase 4% => $V_{out} = 5.2\text{ Vdc}$

$$5.11(5(100+4)/1.225 \times 4 - (100+2 \times 4)/4) = 404 \text{ k}\Omega$$

Output Voltage Adjust Downwards, Decrease:

$$R_{adj} = 5.11(100/\Delta\% - 2) \text{ k}\Omega$$

Eg Decrease 2% => $V_{out} = 4.90\text{ Vdc}$

$$5.11(100/2 - 2) = 245 \text{ k}\Omega$$

The PKM4000C series DC/DC converters can be offered with a baseplate. Baseplate helps to cool hotspots more efficient during heavy load. The baseplate have approximately 5°C improved derating compared to datasheet showing non baseplated PKM4000C. The baseplate is intended to be mounted on a cold wall to transfer heat away from the converter. By mounting PKM4000C in this way thermal derating can be improved by more than 10°C .

PKM 4000C PINB series
DC/DC converters, Input 36-75 V, Output 80 A/204 W

EN/LZT 146 307 R3A Dec 2007

© Ericsson Power Modules AB

12 V Electrical Specification

PKM 4213C PINBSP

$T_{ref} = -40$ to $+90^{\circ}\text{C}$, $V_I = 38$ to 75 V, unless otherwise specified under Conditions.

Typical values given at: $T_{ref} = +25^{\circ}\text{C}$, $V_I = 53$ V, max I_O , unless otherwise specified under Conditions.

Characteristics	Conditions	min	typ	max	Unit		
V_I	Input voltage range	38		75	V		
V_{loff}	Turn-off input voltage	Decreasing input voltage		32	V		
V_{lon}	Turn-on input voltage	Increasing input voltage		34	V		
C_I	Internal input capacitance			5.7	μF		
P_O	Output power	Output voltage initial setting		0	204	W	
SVR	Supply voltage rejection (ac)	f = 100 Hz sinewave, 1 Vp-p		61	dB		
η	Efficiency	50 % of max I_O		94.2	%		
		max I_O		92		93.4	
		50 % of max I_O , $V_I = 48$ V		94.4			
		max I_O , $V_I = 48$ V		93.3			
P_d	Power Dissipation	max I_O		17.7	W		
P_{ii}	Input idling power	$I_O = 0$, $V_I = 53$ V		2.8	W		
P_{RC}	Input standby power	$V_I = 53$ V (turned off with RC)		100	mW		
f_s	Switching frequency	0 -100% of max I_O		180	200	220	kHz

V_{oi}	Output voltage initial setting and accuracy	$T_{ref} = +25^{\circ}\text{C}$, $V_I = 53$ V, $I_O = \text{max } I_O$ V_{adj} , see Note 1	11.8	12.0	12.2	V
	Output adjust range		10.8		13.2	V
V_O	Output voltage tolerance band	10-100% of max I_O	11.7		12.3	V
	Idling voltage	$I_O = 0$	11.8		12.2	V
	Line regulation	max I_O			50	mV
	Load regulation	$V_I = 53$ V, 1-100% of max I_O			20	mV
V_{tr}	Load transient voltage deviation	$V_I = 53$ V, Load step 25-75-25 % of max I_O , $di/dt = 1$ A/ μs , see Note 2	± 800		mV	
t_{tr}	Load transient recovery time		100		μs	
t_r	Ramp-up time (from 10-90 % of V_{oi})	10-100% of max I_O	5	9	20	ms
t_s	Start-up time (from V_I connection to 90% of V_{oi})		7	10	50	ms
I_O	Output current		0		17	A
I_{lim}	Current limit threshold	$V_O = 10.8$ V, $T_{ref} < \text{max } T_{ref}$			21	A
I_{sc}	Short circuit current	$T_{ref} = 25^{\circ}\text{C}$, $V_O = < V_{Onom} * 0.1$			26	A
V_{Oac}	Output ripple & noise	See ripple & noise section, max I_O , V_O .		100	200	mVp-p
OVP	Over Voltage Protection	$T_{ref} = +25^{\circ}\text{C}$, $V_I = 53$ V, $I_O = 0$ -100% of max I_O			14.3	V

Note 1: When using V_{adj} function, max output power (P_O) must not be exceeded

Note 2: Output filter according to Ripple & Noise section

PKM 4000C PINB series
DC/DC converters, Input 36-75 V, Output 80 A/204 W

EN/LZT 146 307 R3A Dec 2007

© Ericsson Power Modules AB

12 V Typical Characteristics

PKM 4213C PINBSP

Efficiency

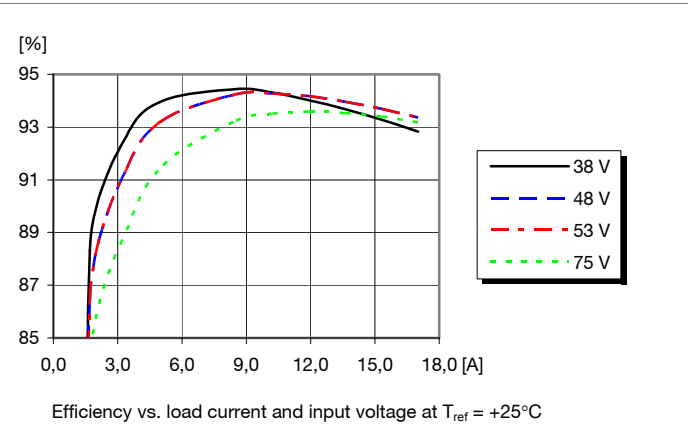

Power Dissipation

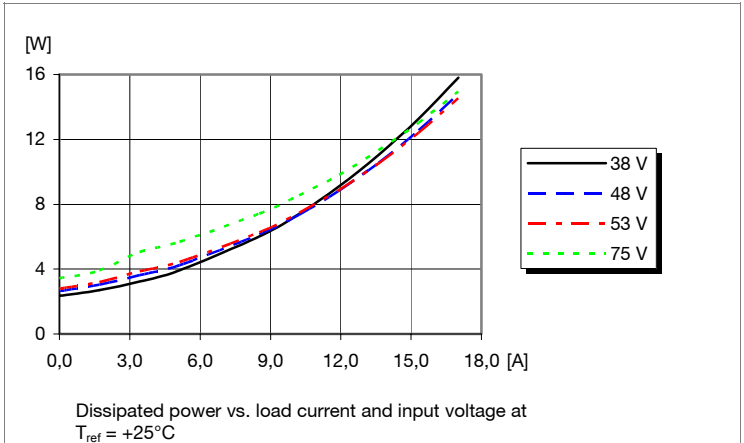

Output Current Derating

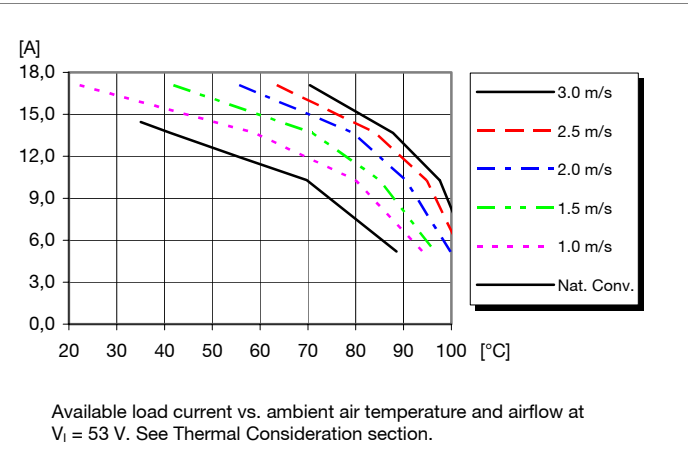

Thermal Resistance

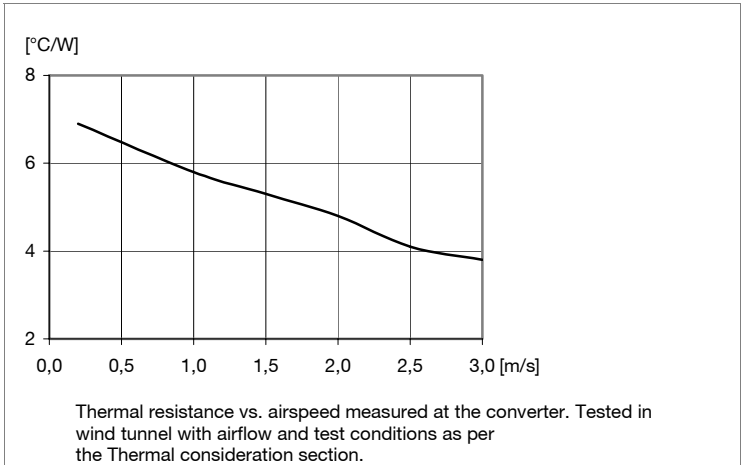

Output Characteristics

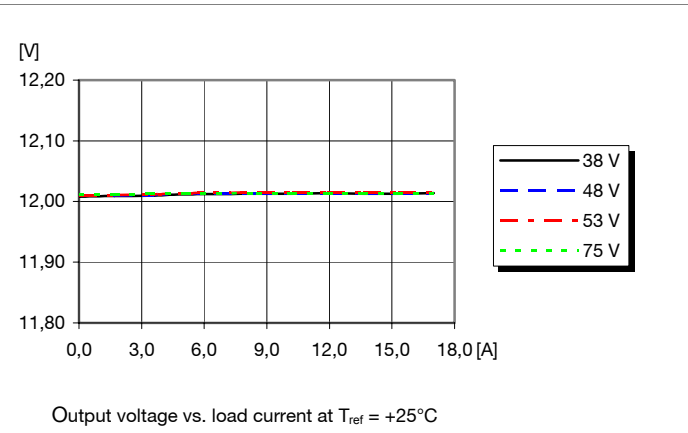

Current Limit Characteristics

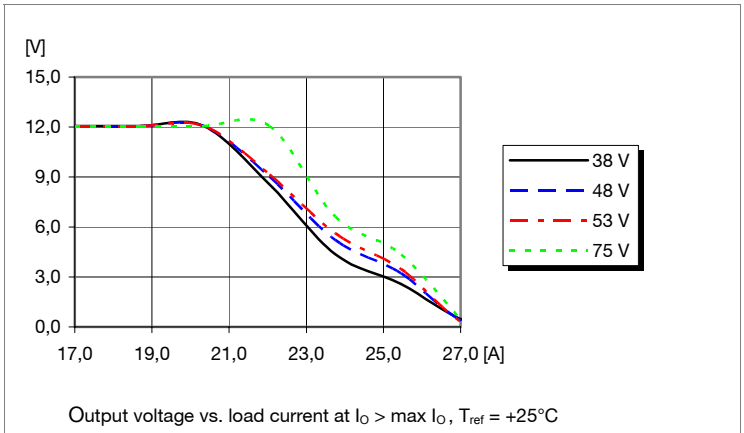

PKM 4000C PINB series
DC/DC converters, Input 36-75 V, Output 80 A/204 W

EN/LZT 146 307 R3A Dec 2007

© Ericsson Power Modules AB

12 V Typical Characteristics

PKM 4213C PINBSP

Start-up

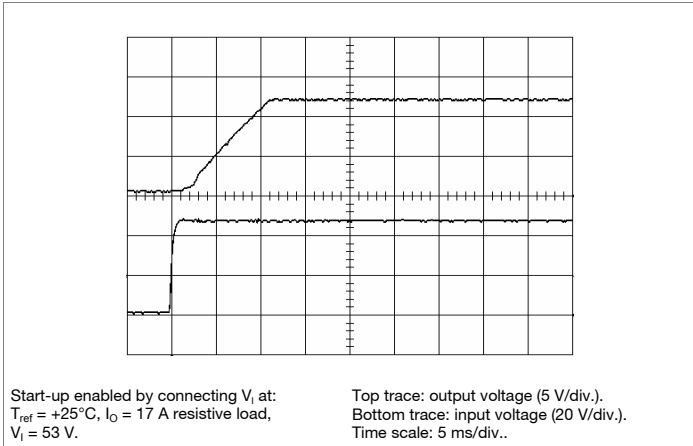

Shut-down

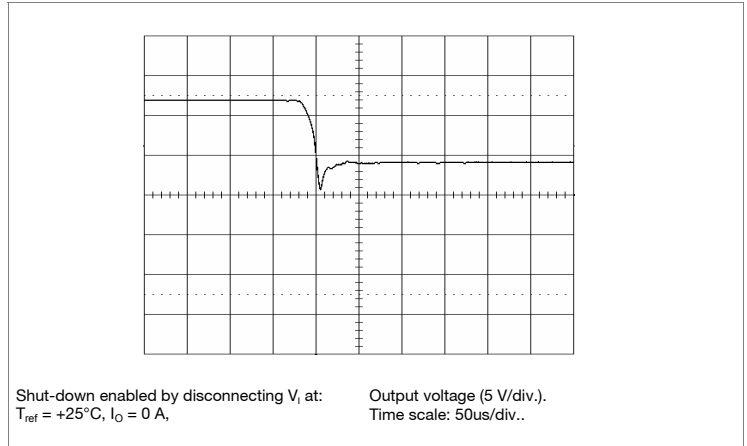

Output Ripple & Noise

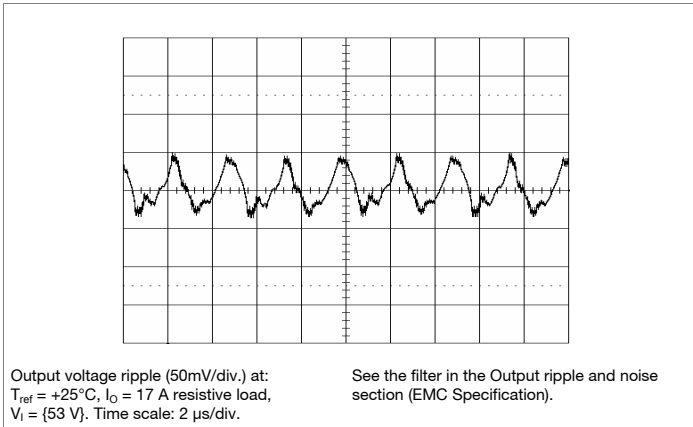

Output Load Transient Response

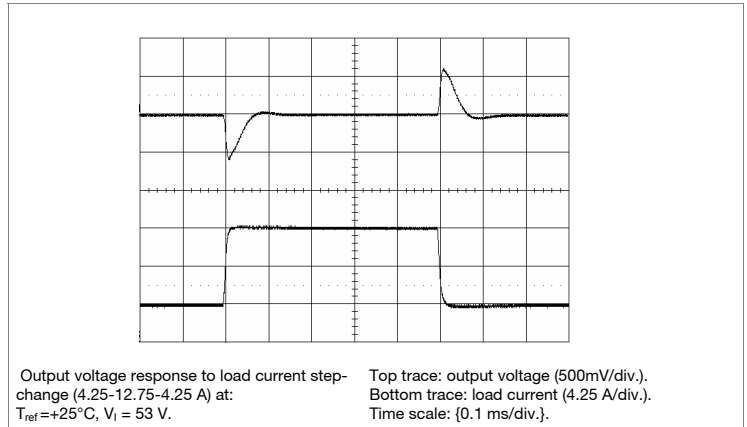

Output Voltage Adjust (see operating information)

Passive trim

The resistor value for an adjusted output voltage is calculated by using the following equations:

Output Voltage Adjust Upwards, Increase:

$$R_{adj} = 5.11((12(100+\Delta\%))/1.225\Delta\% - (100+2\Delta\%)/\Delta\%) \text{ kOhm}$$

Eg Increase 4% => $V_{out} = 12.48\text{ Vdc}$

$$5.11(12(100+4)/1.225 \times 4 - (100+2 \times 4)/4) = 404 \text{ kOhm}$$

Output Voltage Adjust Downwards, Decrease:

$$R_{adj} = 5.11(100/\Delta\% - 2) \text{ kOhm}$$

Eg Decrease 2% => $V_{out} = 11.76\text{ Vdc}$

$$5.11(100/2 - 2) = 245 \text{ kOhm}$$

Baseplate

The PKM4000C series DC/DC converters can be offered with a baseplate. Baseplate helps to cool hotspots more efficient during heavy load. The baseplate have approximately 5°C improved derating compared to datasheet showing non baseplated PKM4000C. The baseplate is intended to be mounted on a cold wall to transfer heat away from the converter. By mounting PKM4000C in this way thermal derating can be improved by more than 10°C.

PKM 4000C PINB series
DC/DC converters, Input 36-75 V, Output 80 A/204 W

EN/LZT 146 307 R3A Dec 2007
© Ericsson Power Modules AB

EMC Specification

Conducted EMI measured according to EN55022, CISPR 22 and FCC part 15J (see test set-up).
The fundamental switching frequency is 200 kHz for PKM 4211C PINB @ $V_I = 53 V$, max I_O .

Conducted EMI Input terminal value (typ)

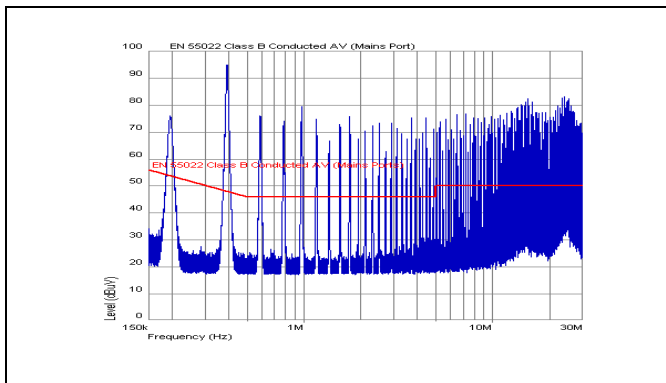

EMI without filter

External filter (class B)

Required external input filter in order to meet class B in EN 55022, CISPR 22 and FCC part 15J.

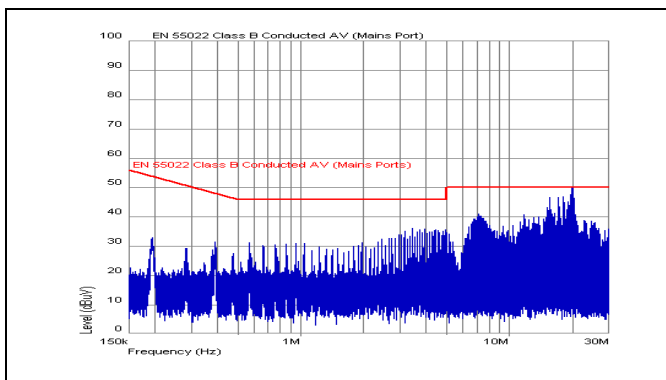
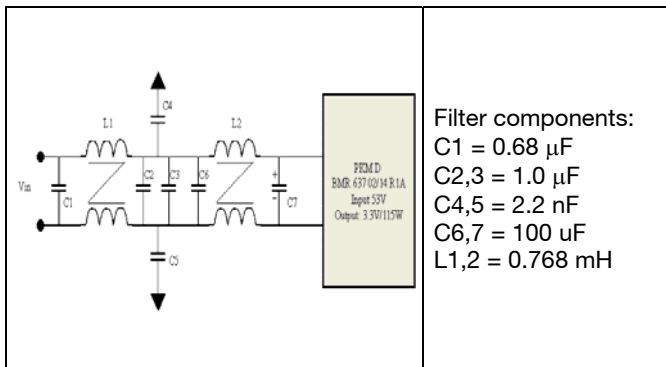

EMI with filter

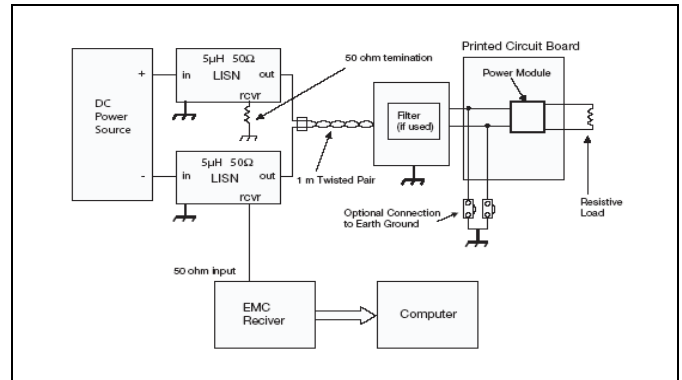

Test set-up

Layout recommendation

The radiated EMI performance of the DC/DC converter will depend on the PCB layout and ground layer design. It is also important to consider the stand-off of the DC/DC converter. If a ground layer is used, it should be connected to the output of the DC/DC converter and the equipment ground or chassis.

A ground layer will increase the stray capacitance in the PCB and improve the high frequency EMC performance.

Output ripple and noise

Output ripple and noise measured according to figure below. See Design Note 022 for detailed information.

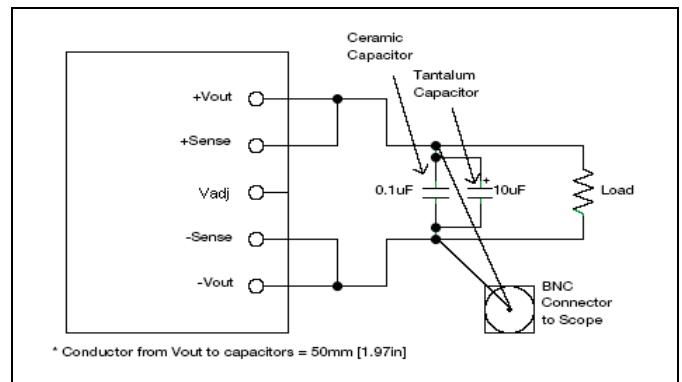

Output ripple and noise test setup

PKM 4000C PINB series
DC/DC converters, Input 36-75 V, Output 80 A/204 W

EN/LZT 146 307 R3A Dec 2007
© Ericsson Power Modules AB

Operating information

Input Voltage

The input voltage range 36 to 75Vdc meets the requirements of the European Telecom Standard ETS 300 132-2 for normal input voltage range in -48 and -60 Vdc systems, -40.5 to -57.0 V and -50.0 to -72 V respectively. At input voltages exceeding 75 V, the power loss will be higher than at normal input voltage and T_{ref} must be limited to absolute max +110°C. The absolute maximum continuous input voltage is 80Vdc.

Turn-off Input Voltage

The PKM 4000C Series DC/DC converters monitor the input voltage and will turn on and turn off at predetermined levels. The minimum hysteresis between turn on and turn off input voltage is 1 V.

Remote Control (RC)

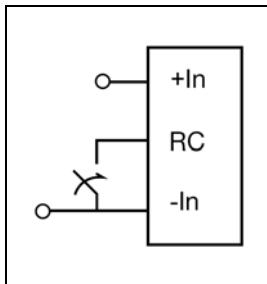

The products are fitted with a remote control function referenced to the primary negative input connection (- In), with negative and positive logic options available. The RC function allows the converter to be turned on/off by an external device like a semiconductor or mechanical switch. The RC pin has an internal pull up resistor to + In.

The maximum required sink current is 1 mA. When the RC pin is left open, the voltage generated on the RC pin is 3.5 – 6.0 V.

The second option is “positive logic” remote control, which can be ordered by adding the suffix “P” to the end of the part number. The converter will turn on when the input voltage is applied with the RC pin open. Turn off is achieved by connecting the RC pin to the - In. To ensure safe turn off the voltage difference between RC pin and the - In pin shall be less than 1V. The converter will restart automatically when this connection is opened.

See Design Note 021 for detailed information.

Input and Output Impedance

The impedance of both the power source and the load will interact with the impedance of the DC/DC converter. It is most important to have a low characteristic impedance, both at the input and output, as the converters have a low energy storage capability. The PKM 4000C Series DC/DC converters have been designed to be completely stable without the need for external capacitors on the input or the output circuits. The performance in some applications can be enhanced by addition of external capacitance as described under maximum capacitive load. If the distribution of the input voltage source to the converter contains significant inductance, the addition of a 100µF capacitor across the input of the converter will help insure stability. This capacitor

is not required when powering the DC/DC converter from a low impedance source with short, low inductance, input power leads.

External Decoupling Capacitors

When powering loads with significant dynamic current requirements, the voltage regulation at the point of load can be improved by addition of decoupling capacitors at the load. The most effective technique is to locate low ESR ceramic and electrolytic capacitors as close to the load as possible, using several parallel capacitors to lower the effective ESR. The ceramic capacitors will handle high-frequency dynamic load changes while the electrolytic capacitors are used to handle low frequency dynamic load changes. Ceramic capacitors will also reduce any high frequency noise at the load.

It is equally important to use low resistance and low inductance PCB layouts and cabling.

External decoupling capacitors will become part of the control loop of the DC/DC converter and may affect the stability margins. As a “rule of thumb”, 100 µF/A of output current can be added without any additional analysis. The ESR of the capacitors is a very important parameter. Power Modules guarantee stable operation with a verified ESR value of >10 mΩ across the output connections.

For further information please contact your local Ericsson Power Modules representative.

Output Voltage Adjust (V_{adj})

All PKM 4000C Series DC/DC converters have an Output Voltage adjust pin (V_{adj}). This pin can be used to adjust the output voltage above or below Output voltage initial setting. When increasing the output voltage, the voltage at the output pins (including any remote sense offset) must be kept below the maximum output adjust range. Also note that at increased output voltages the maximum power rating of the converter remains the same, and the output current capability will decrease correspondingly.

To decrease the output voltage the resistor should be connected between V_{adj} pin and -Sense pin. To increase the voltage the resistor should be connected between V_{adj} pin and +Sense pin. The resistor value of the Output voltage adjust function is according to information given under the output section.

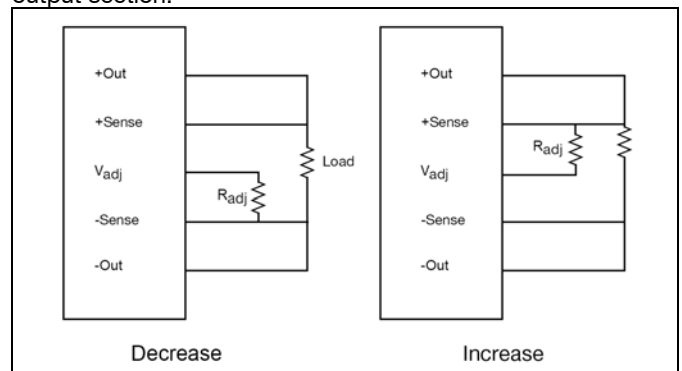

PKM 4000C PINB series DC/DC converters, Input 36-75 V, Output 80 A/204 W	EN/LZT 146 307 R3A Dec 2007 © Ericsson Power Modules AB
---	--

Operating information continued

Parallel Operation

The PKM 4000C Series DC/DC converters can be paralleled for redundancy if external o-ring diodes are used in series with the outputs. It is not recommended to parallel the PKM 4000C Series DC/DC converters for increased power without using external current sharing circuits.

See Design Note 006 for detailed information.

Remote Sense

All PKM 4000C Series DC/DC converters have remote sense that can be used to compensate for moderate amounts of resistance in the distribution system and allow for voltage regulation at the load or other selected point. The remote sense lines will carry very little current and do not need a large cross sectional area. However, the sense lines on the Pcb should be located close to a ground trace or ground plane. In a discrete wiring situation, the use of twisted pair wires or other technique to reduce noise susceptibility is highly recommended. The remote sense circuitry will compensate for up to 10% voltage drop between the sense voltage and the voltage at the output pins. The output voltage and the remote sense voltage offset must be less than the minimum over voltage trip point. If the remote sense is not needed the -Sense should be connected to -Out and +Sense should be connected to +Out.

Over Temperature Protection (OTP)

The PKM 4000C Series DC/DC converters are protected from thermal overload by an internal over temperature shutdown circuit. When the Pcb temperature (TC reference point) exceeds the temperature trig point (~120 °C) the OTP circuit will cut down output power. The converter will stop until safe operating temperature is restored. Hysteresis between OTP trig point and restart is approx 10°C. Time between OTP and restart is dependant on cooling of DC/DC converter.

Over Voltage Protection (OVP)

The PKM 4000C Series DC/DC converters have output overvoltage protection. In the event of an output overvoltage condition, the converter will shut down immediately. The converter make continous attempts to start up (non-latching mode) and resume normal operation automatically.

Over Current Protection (OCP)

The PKM 4000C Series DC/DC converters include current limiting circuitry that allows them to withstand continuous overloads or short circuit conditions on the output. The output voltage will decrease towards zero for output currents in excess of max output current (Iomax).

The converter will resume normal operation after removal of the overload. The load distribution system should be designed to carry the maximum output short circuit current specified.

Thermal Consideration

General

The PKM 4000C series DC/DC converters are designed to operate in a variety of thermal environments, however sufficient cooling should be provided to help ensure reliable operation. Heat is removed by conduction, convection and radiation to the surrounding environment. Increased airflow enhances the heat transfer via convection. The available load current vs. ambient air temperature and airflow at Vin =53 V for each model is according to the information given under the output section. The test is done in a wind tunnel with a cross section of 305 x 305 mm, the DC/DC converter vertically mounted on a 16 layer Pcb with a size of 254 x 254 mm, each layer with 35 μm (1 oz) copper. Proper cooling can be verified by measuring the temperature of selected devices. Peak temperature can occur at positions P1 - P4. The temperature at these positions should not exceed the recommended max values.

Note that the max value is the absolute maximum rating (non destruction) and that the electrical Output data is guaranteed up to T_{ref} +90°C.

See Design Note 019 for further information.

Position	Device	Designation	max value
P ₁	Pcb	T _{ref}	110° C
P ₂	Mosfet	T _{surface}	120° C
P ₃	Mosfet	T _{surface}	120° C
P ₄	Transformer	T _{surface}	130° C

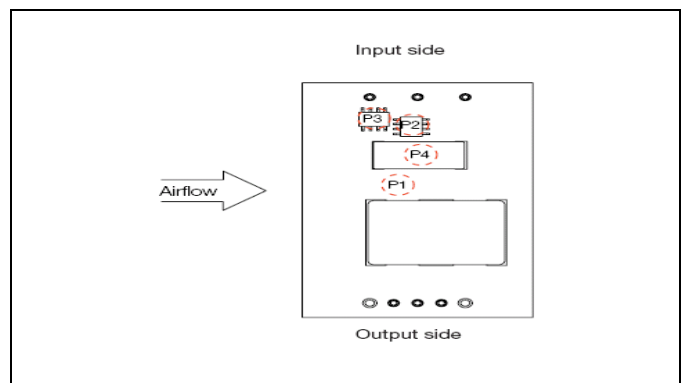

PKM 4000C PINB series
DC/DC converters, Input 36-75 V, Output 80 A/204 W

EN/LZT 146 307 R3A Dec 2007

© Ericsson Power Modules AB

Thermal Consideration continued

Definition of reference temperature (T_{ref})

The reference temperature is used to monitor the temperature limits of the product. Temperatures above maximum T_{ref} are not allowed and may cause degradation or permanent damage to the product. T_{ref} is also used to define the temperature range for normal operating conditions. T_{ref} is defined by the design and used to guarantee safety margins, proper operation and high reliability of the module.

Ambient Temperature Calculation

By using the thermal resistance the maximum allowed ambient temperature can be calculated.

1. The power loss is calculated by using the formula $((1/\eta) - 1) \times \text{output power} = \text{power losses (Pd)}$.
 η = efficiency of converter. E.g 90 % = 0.90
2. Find the thermal resistance (R_{th}) in the Thermal Resistance graph found in the Output section for each model. Calculate the temperature increase (ΔT).
 $\Delta T = R_{th} \times P_d$
3. Max allowed ambient temperature is:
Max T_{ref} - ΔT .

E.g PKM 4213C PINBSP at 2m/s:

1. $((\frac{1}{0.933}) - 1) \times 204 \text{ W} = 14.6 \text{ W}$
2. $14.6 \text{ W} \times 5.7^\circ\text{C/W} = 83^\circ\text{C}$
3. $110^\circ\text{C} - 83^\circ\text{C} = \text{max ambient temperature is } 27^\circ\text{C}$

The real temperature will be dependent on several factors, like Pcb size and type, direction of airflow, air turbulence etc. It is recommended to verify the temperature by testing.

Connections

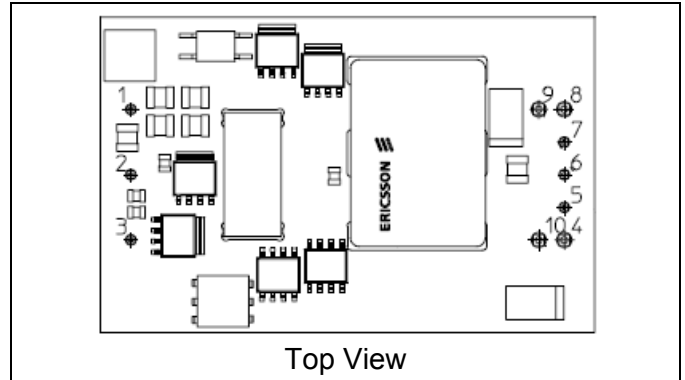

Pin	Designation	Function
1	+In	Positive input
2	RC	Remote control
3	- In	Negative input
4,10	- Out	Negative output
5	- Sen	Negative remote sense
6	Vadj	Output voltage adjust
7	+ Sen	Positive remote sense
8,9	+ Out	Positive output

PKM 4000C PINB series
DC/DC converters, Input 36-75 V, Output 80 A/204 W

EN/LZT 146 307 R3A Dec 2007

© Ericsson Power Modules AB

Mechanical Drawing for Single Pin out

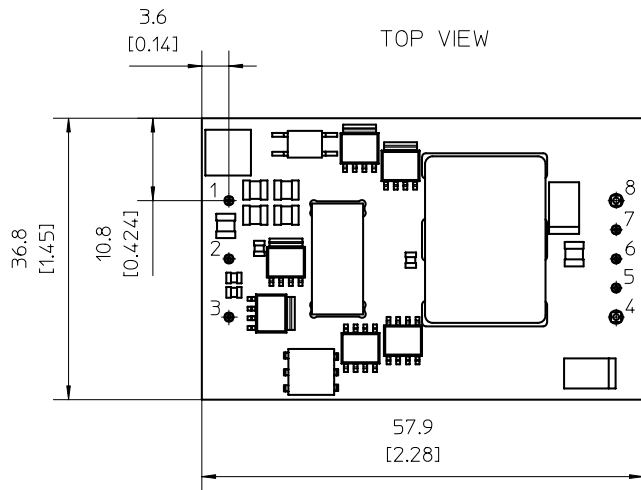
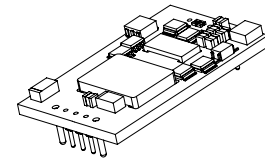
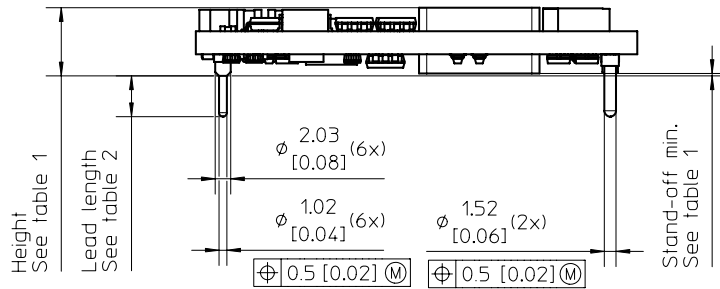

Recommended footprint - TOP VIEW

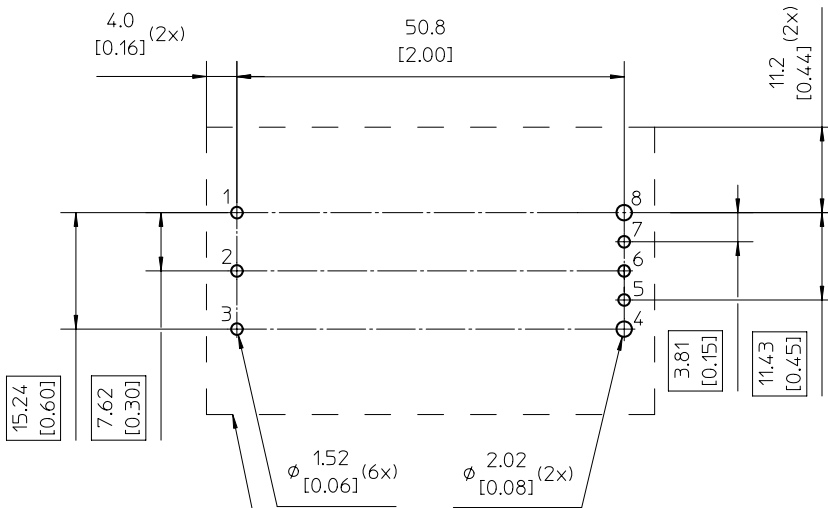

Recommended keep away area for user components.

Table 1

Height option	Height max.	Stand-off min.
Standard	9.35 [0.368]	0.07 [0.003]
M	10.53 [0.415]	1.25 [0.049]

Table 2

Pin option	Lead Length
Standard	5.33 [0.210]
LA	3.69 [0.145]
LB	4.57 [0.180]

Weight: Typical 40g

Pins:

Material, pins 1-3, 5-7: Brass

Material, pins 4, 8: Copper alloy

Plating: 0,1 μ m Gold over 2 μ m Nickel

All dimensions are in mm [inches]

Tolerances unless specified

x.x \pm 0.5 [0.02]

x.xx \pm 0.25 [0.01]

Not applied on the recommended footprint



PKM 4000C PINB series
DC/DC converters, Input 36-75 V, Output 80 A/204 W

EN/LZT 146 307 R3A Dec 2007

© Ericsson Power Modules AB

Mechanical Drawing for Double Pin out

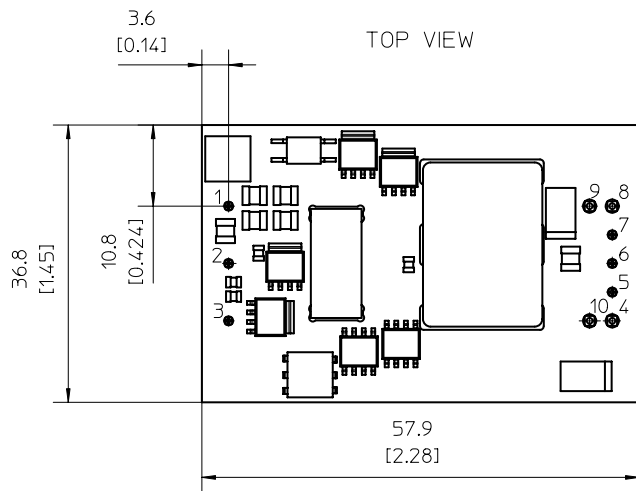
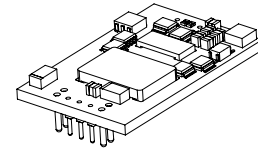
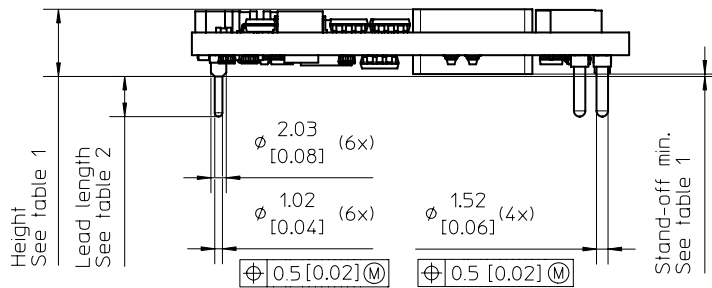

Recommended footprint - TOP VIEW

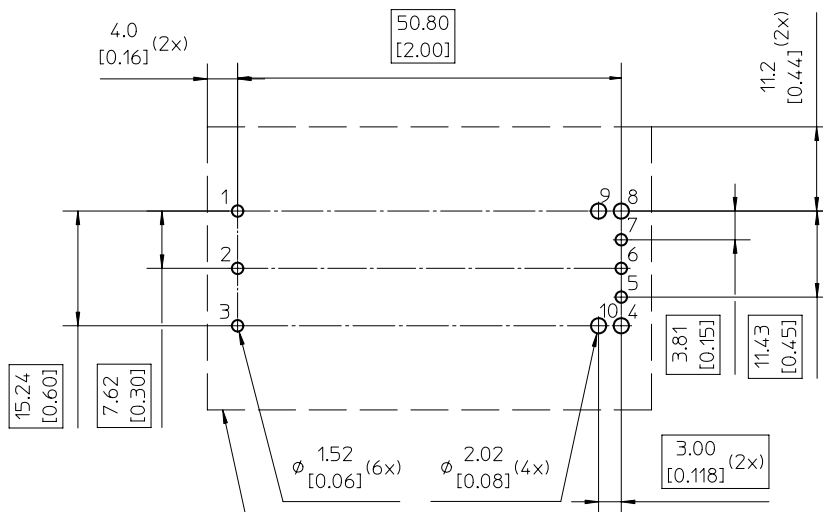

Recommended keep away area for user components.

Table 1

Height option	Height max.	Stand-off min.
Standard	9.35 [0.368]	0.07 [0.003]
M	10.53 [0.415]	1.25 [0.049]

Table 2

Pin option	Lead Length
Standard	5.33 [0.210]
LA	3.69 [0.145]
LB	4.57 [0.180]

Weight: Typical 40g

Pins:

Material, pins 1-3, 6-8: Brass

Material, pins 4-5, 9-10: Copper alloy

Plating: 0,14µm Gold over 24µm Nickel

All dimensions are in mm [inches]

Tolerances unless specified

x.x ± 0.5 [0.02]

x.xx ± 0.25 [0.01]

Not applied on the recommended footprint



PKM 4000C PINB series
DC/DC converters, Input 36-75 V, Output 80 A/204 W

EN/LZT 146 307 R3A Dec 2007

© Ericsson Power Modules AB

Mechanical Drawing for Base plate option with Single Pin out

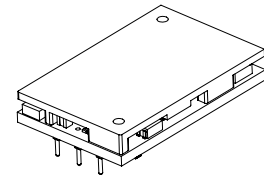
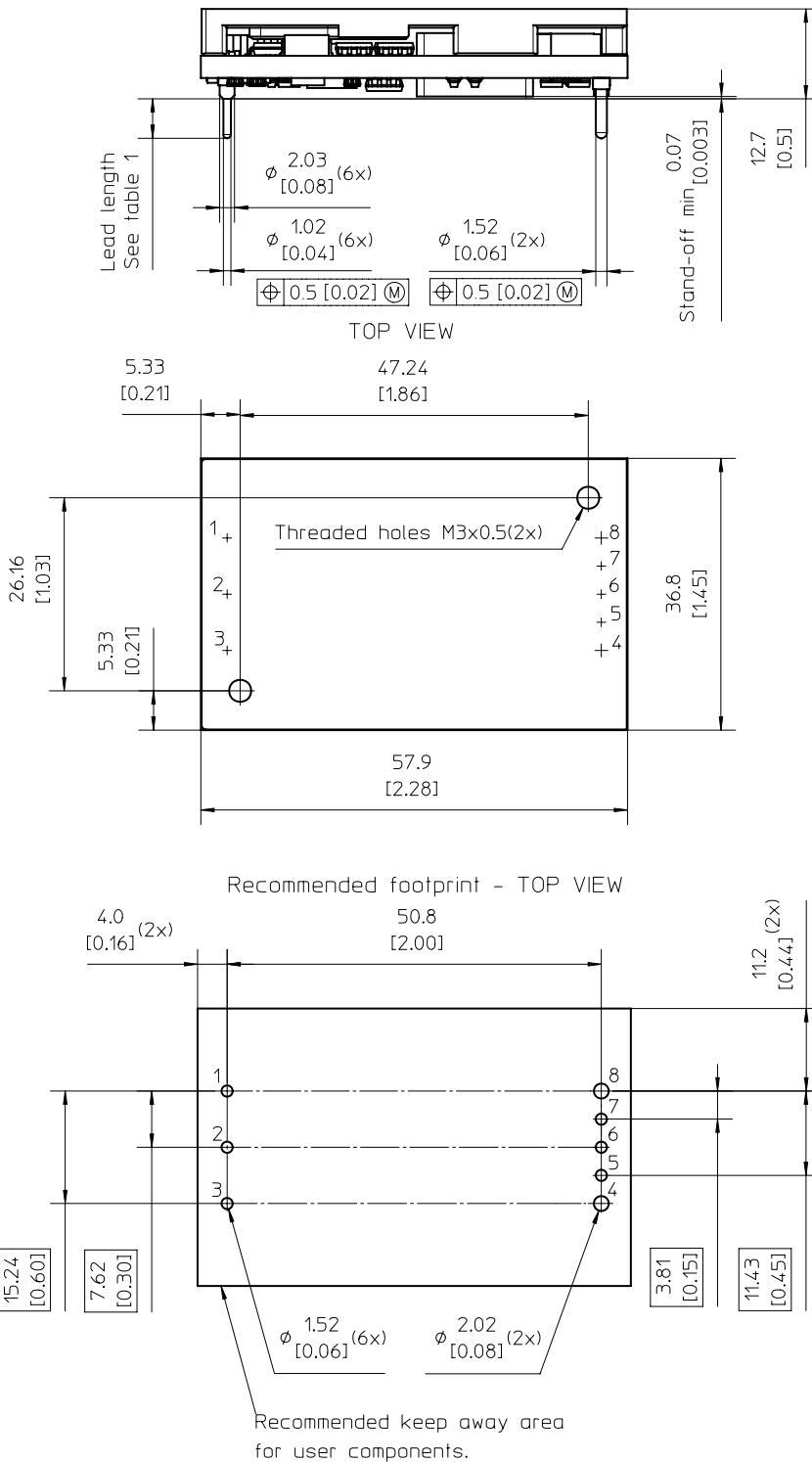

Table 1

Pin option	Lead Length
Standard	5.33 [0.210]
LA	3.69 [0.145]
LB	4.57 [0.180]

Weight: Typical 65g

Pins:

Material, pins 1-3, 5-7: Brass

Material, pins 4-8: Copper alloy

Plating: 0,1 μ m Gold over 2 μ m Nickel

All dimensions are in mm [inches]

Tolerances unless specified

x.x \pm 0.5 [0.02]

x.xx \pm 0.25 [0.01]

Not applied on the recommended footprint



PKM 4000C PINB series
DC/DC converters, Input 36-75 V, Output 80 A/204 W

EN/LZT 146 307 R3A Dec 2007

© Ericsson Power Modules AB

Mechanical Drawing for Base plate option with Double Pin out

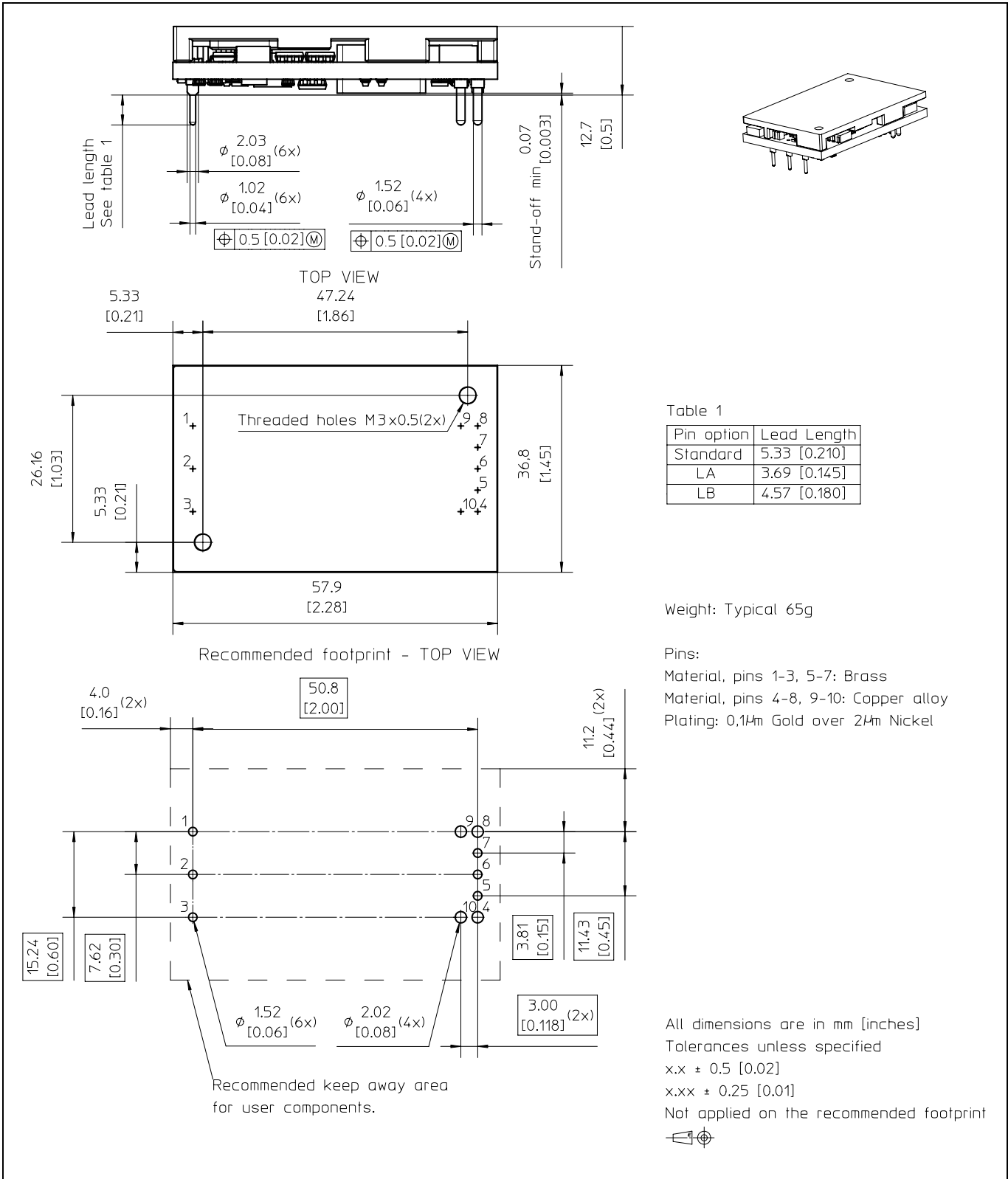

PKM 4000C PINB series
DC/DC converters, Input 36-75 V, Output 80 A/204 W

EN/LZT 146 307 R3A Dec 2007

© Ericsson Power Modules AB

Soldering Information – Through hole mounting

The product is intended for through hole mounting in a PCB. When wave soldering is used, the temperature on the pins is specified to maximum 260 °C for maximum 10 seconds.

Maximum preheat rate of 4 °C/s and temperature of max 150 °C is suggested. When hands soldering care should be taken to avoid direct contact between the hot soldering iron tip and the pins for more than a few seconds in order to prevent overheating.

A no-clean (NC) flux is recommended to avoid entrapment of cleaning fluids in cavities inside of the DC/DC power module. The residues may affect long time reliability and isolation voltage.

Delivery package information

The products are delivered in antistatic trays.

Tray specifications	
Material	Polyethylene foam, dissipative
Surface resistance	$10^5 < \Omega/\text{square} < 10^{12}$
Bake ability	The trays are not bakeable
Tray capacity	20 products/tray
Tray height	25.4 mm [1.0 inch]
Box capacity	20 products (1 full tray/box)
Tray weight	100 g empty, 1400 g full maximum

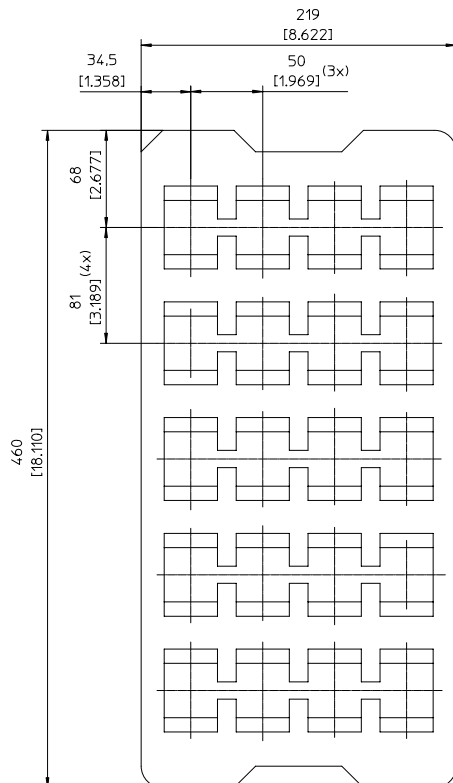

PKM 4000C PINB series DC/DC converters, Input 36-75 V, Output 80 A/204 W	EN/LZT 146 307 R3A Dec 2007
	© Ericsson Power Modules AB

Product Qualification Specification

Characteristics			
External visual inspection	IPC-A-610		
Change of temperature (Temperature cycling)	IEC 60068-2-14 Na	Temperature range Number of cycles Dwell/transfer time	-40 to +100 °C 300 30 min/0-1 min
Cold (in operation)	IEC 60068-2-1 Bc	Temperature T _A Duration	-40°C 2 h
Damp heat	IEC 60068-2-3 Ca	Temperature Humidity Duration	+85 °C 85 % RH 1000 hours
Dry heat	IEC 60068-2-2 Ba	Temperature Duration	+125 °C 1000 h
Heat (in operation)	IEC 60068-2-1 Ad	Temperature T _A Duration	+90 °C 72 h
Immersion in cleaning solvents	IEC 60068-2-45 XA Method 2	Water Glycol ether Isopropanol	+55 ±5 °C +35 ±5 °C +35 ±5 °C
Mechanical shock	IEC 60068-2-27 Ea	Peak acceleration Duration Pulse shape Directions Number of pulses	100 g 3 ms Half sine 6 18 (3 + 3 in each perpendicular direction)
Resistance to soldering heat	IEC 60068-2-20 Tb Method 1A	Solder temperature Duration	260 °C 10 s
Robustness of terminations	IEC 60068-2-21 Ua1	Tensile force	20 N for 10 s /signal pin 40 N for 10 s /power pin
Solderability	IEC 60068-2-54	Preconditioning Temperature, SnPb Eutectic	ageing 240 h 85°C /85%RH 235°C
Vibration, broad band random	IEC 60068-2-34 Eb	Frequency Spectral density Duration	10 to 500 Hz 0.025 g ² /Hz 10 min in each 3 perpendicular directions