

Product Summary

BV _{bss}	R _{Ds(ON)}	I _D T _A = +25°C
-250V	14Ω @ V _{GS} = -10V	-265mA

Description and Applications

This new generation trench MOSFET features a unique structure combining the benefits of low on-resistance and fast switching, making it ideal for high efficiency power management applications.

- Earth Recall and Dialling Switches
- Electronic Hook Switches
- High Voltage Power MOSFET Drivers
- Telecom Call Routers
- Solid State Relays

Features and Benefits

- High Voltage
- Low On-resistance
- Fast Switching Speed
- Low Gate Drive
- Low Threshold
- **Lead-Free Finish; RoHS Compliant (Notes 1 & 2)**
- **Halogen and Antimony Free. "Green" Device (Note 3)**
- **For automotive applications requiring specific change control (i.e.: parts qualified to AEC-Q100/101/200, PPAP capable, and manufactured in IATF 16949 certified facilities), please refer to the related automotive grade (Q-suffix) part. A listing can be found at <https://www.diodes.com/products/automotive/automotive-products/>.**
- **This part is qualified to JEDEC standards (as references in AEC-Q) for High Reliability. <https://www.diodes.com/quality/product-definitions/>**

Mechanical Data

- Package: SOT223
- Package Material: Molded Plastic, "Green" Molding Compound; UL Flammability Classification Rating 94V-0
- Moisture Sensitivity: Level 1 per J-STD-020
- Terminals: Matte Tin Finish (Ⓔ3)
- Weight: 0.112 grams (Approximate)

SOT223 (Type DN)

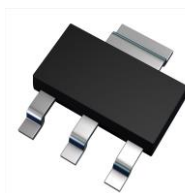

Top View

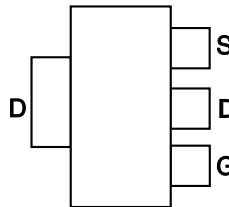

Pin Out - Top

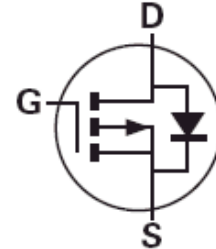

Equivalent Circuit

Ordering Information (Note 4)

Part Number	Package	Packing	
		Qty.	Carrier
ZVP4525GTA	SOT223 (Type DN)	1,000	Tape & Reel

- Notes:
1. EU Directive 2002/95/EC (RoHS), 2011/65/EU (RoHS 2) & 2015/863/EU (RoHS 3) compliant. All applicable RoHS exemptions applied.
 2. See <https://www.diodes.com/quality/lead-free/> for more information about Diodes Incorporated's definitions of Halogen- and Antimony-free, "Green" and Lead-free.
 3. Halogen- and Antimony-free "Green" products are defined as those which contain <900ppm bromine, <900ppm chlorine (<1500ppm total Br + Cl) and <1000ppm antimony compounds.
 4. For packaging details, go to our website at <https://www.diodes.com/design/support/packaging/diodes-packaging/>.

Marking Information

SOT223 (Type DN)

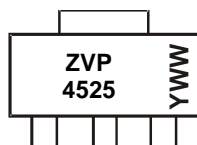

ZVP4525 = Product Type Marking Code
 YWW = Date Code Marking
 Y or \bar{Y} = Last Digit of Year (ex: 1 = 2021)
 WW or $\bar{W}W$ = Week Code (01 to 53)

Maximum Ratings (@T_A = +25°C, unless otherwise specified.)

Characteristic	Symbol	Value	Unit
Drain-Source Voltage	V _{DSS}	-250	V
Gate-Source Voltage	V _{GSS}	±40	V
Continuous Drain Current @V _{GS} = 10V; T _A = +25°C (Note 5) @V _{GS} = 10V; T _A = +70°C (Note 5)	I _D	-265 -212	mA
Pulsed Drain Current (Note 7)	I _{DM}	-1	A
Continuous Source Current (Body Diode)	I _S	-0.265	A
Pulsed Source Current (Body Diode)	I _{SM}	-1	A

Thermal Characteristics (@T_A = +25°C, unless otherwise specified.)

Characteristic	Symbol	Value	Unit
Power Dissipation at T _A = +25°C (Note 5)	P _D	2.0	W
Linear Derating Factor		16	mW/°C
Thermal Resistance, Junction to Ambient (Note 5)	R _{θJA}	63	°C/W
Thermal Resistance, Junction to Ambient (Note 6)	R _{θJA}	26	°C/W
Operating and Storage Temperature Range	T _J , T _{STG}	-55 to +150	°C

- Notes:
- For a device surface mounted on 25mm x 25mm FR4 PCB with high coverage of single sided 1oz copper, in still air conditions.
 - For a device surface mounted on FR4 PCB measured at t ≤ 5 secs.
 - Repetitive rating 25mm x 25mm FR4 PCB, D=0.02 pulse width=300µs - pulse width limited by maximum junction temperature.

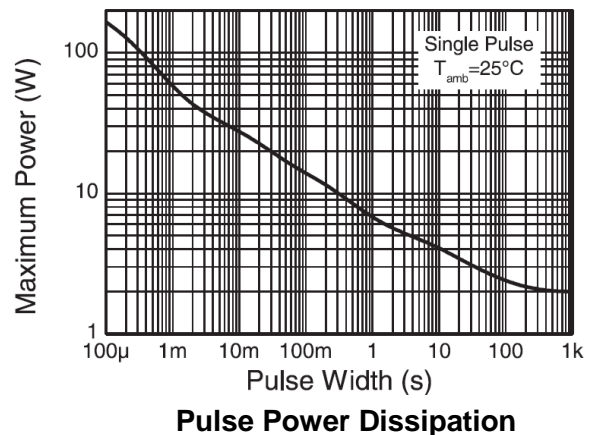
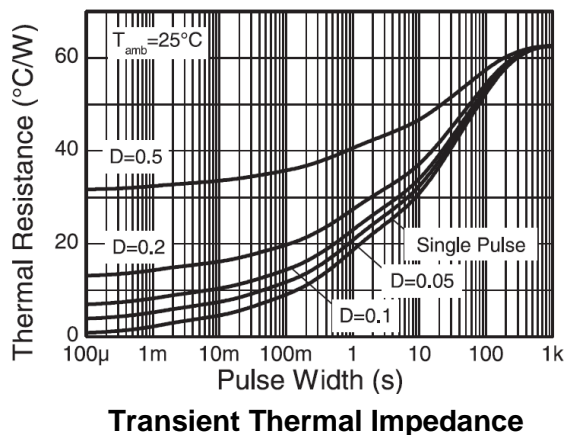
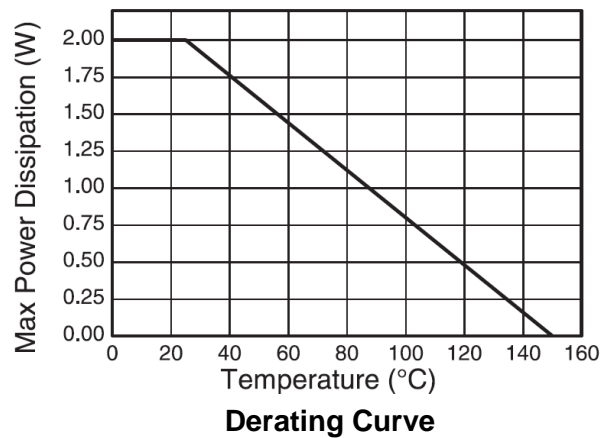
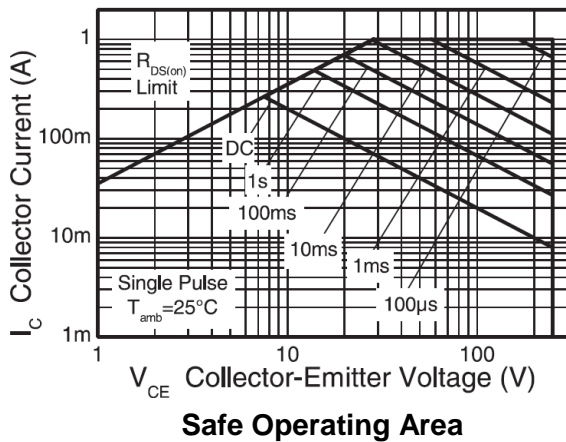

Electrical Characteristics (@T_A = +25°C, unless otherwise specified.)

Characteristic	Symbol	Min	Typ	Max	Unit	Test Condition
OFF CHARACTERISTICS						
Drain-Source Breakdown Voltage	B _V DSS	-250	-285	—	V	V _{GS} = 0V, I _D = -1mA
Zero Gate Voltage Drain Current	I _{DSS}	—	-30	-500	nA	V _{DS} = -250V, V _{GS} = 0V
Gate-Source Leakage	I _{GSS}	—	±1	±100	nA	V _{GS} = ±40V, V _{DS} = 0V
ON CHARACTERISTICS						
Gate Threshold Voltage	V _{GS(TH)}	-0.8	-1.5	-2.0	V	V _{DS} = V _{GS} , I _D = -1mA
Static Drain-Source On-Resistance (Note 8)	R _{DS(ON)}	—	10	14	Ω	V _{GS} = -10V, I _D = -200mA
		—	13	18	Ω	V _{GS} = -3.5V, I _D = -100mA
Forward Transconductance (Note 10)	g _{fs}	80	200	—	mS	V _{DS} = -10V, I _D = -0.15A
Diode Forward Voltage (Note 8)	V _{SD}	—	—	0.97	V	I _S = -200mA, V _{GS} = 0V, T _J = +25°C
DYNAMIC CHARACTERISTICS						
Input Capacitance (Note 10)	C _{iSS}	—	73	—	pF	V _{DS} = -25V, V _{GS} = 0V, f = 1.0MHz
Output Capacitance (Note 10)	C _{oss}	—	12.8	—	pF	
Reverse Transfer Capacitance (Note 10)	C _{rSS}	—	3.91	—	pF	
Total Gate Charge (Notes 9 & 10)	Q _g	—	2.45	3.45	nC	V _{GS} = -10V, V _{DS} = -25V I _D = -200mA
Gate-Source Charge (Notes 9 & 10)	Q _{gs}	—	0.22	0.31	nC	
Gate-Drain Charge (Notes 9 & 10)	Q _{gd}	—	0.45	0.63	nC	
Turn-On Delay Time (Notes 9 & 10)	t _{D(ON)}	—	1.53	—	ns	V _{DD} = -30V, I _D = -200mA, V _{GS} = -10V, R _G = 50Ω
Turn-On Rise Time (Notes 9 & 10)	t _r	—	3.78	—	ns	
Turn-Off Delay Time (Notes 9 & 10)	t _{D(OFF)}	—	17.5	—	ns	
Turn-Off Fall Time (Notes 9 & 10)	t _f	—	7.85	—	ns	
Reverse Recovery Time (Note 10)	t _{RR}	—	205	290	ns	I _F = -200mA, di/dt = 100A/μs, T _J = +25°C
Reverse Recovery Charge (Note 10)	Q _{RR}	—	21	29	nC	

Notes:
 8. Measured under pulsed conditions. Pulse width ≤ 300μs; duty cycle ≤ 2%.
 9. Switching characteristics are independent of operating junction temperature.
 10. For design aid only, not subject to production testing.

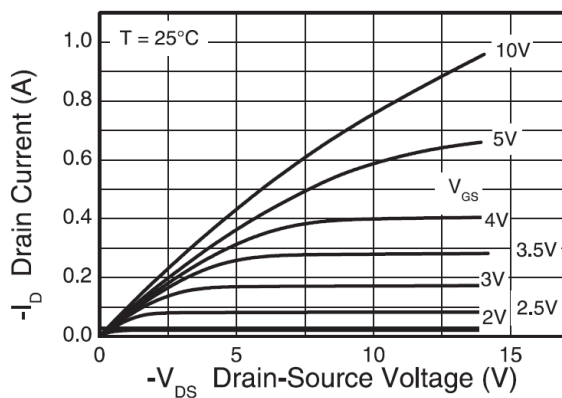
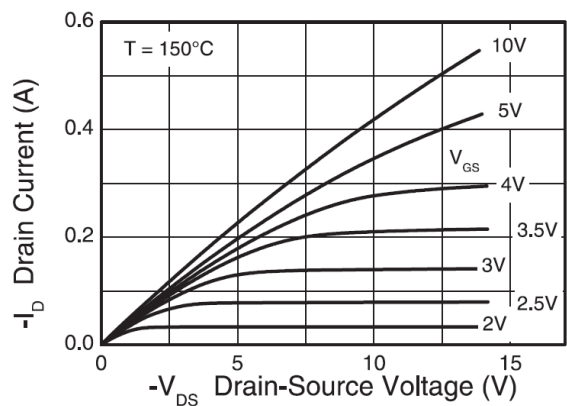

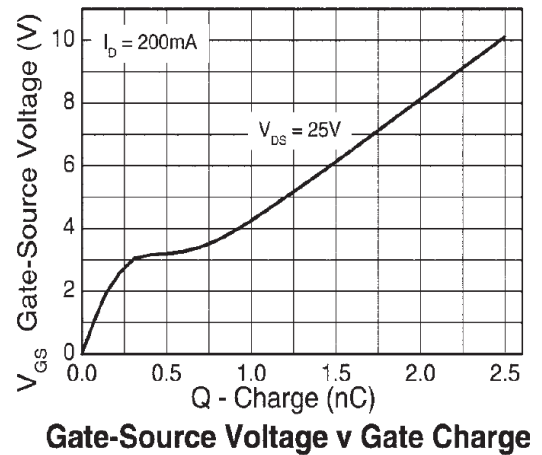
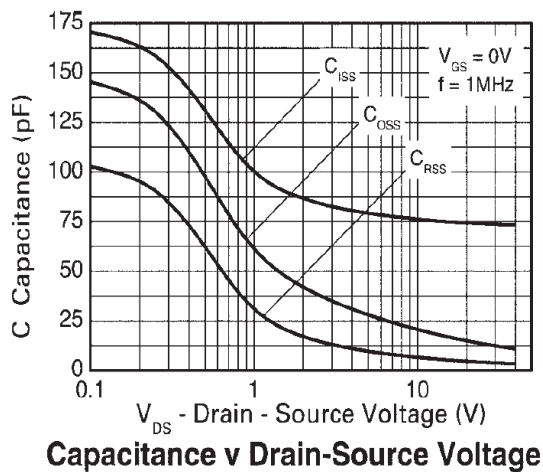
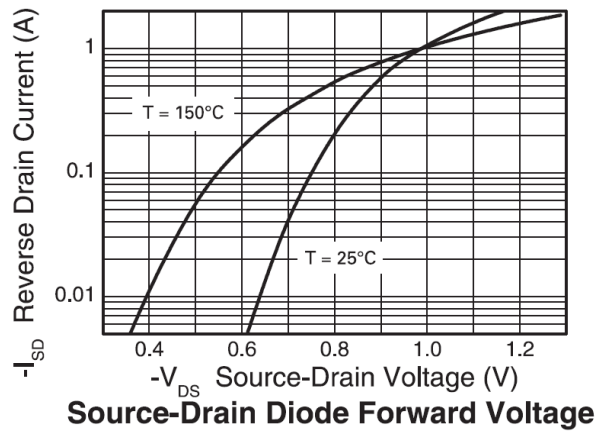
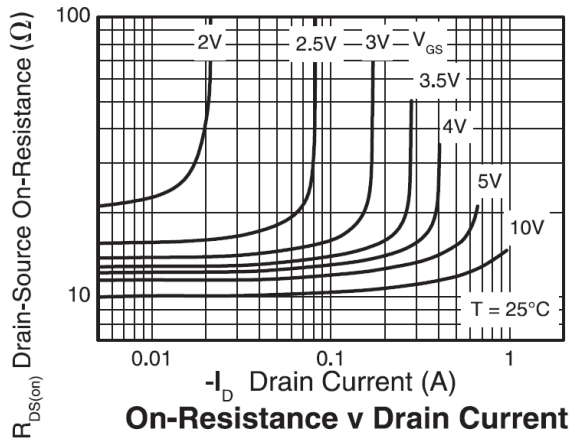
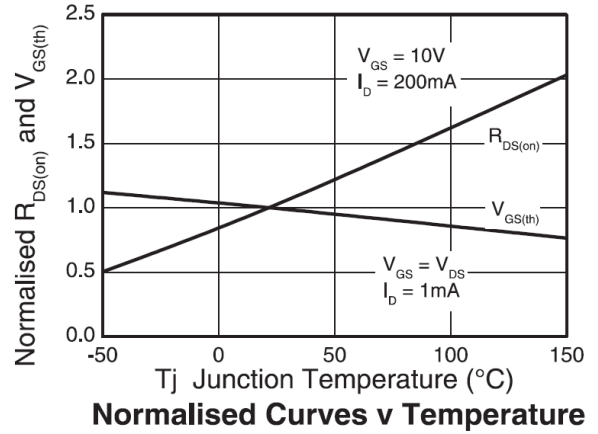
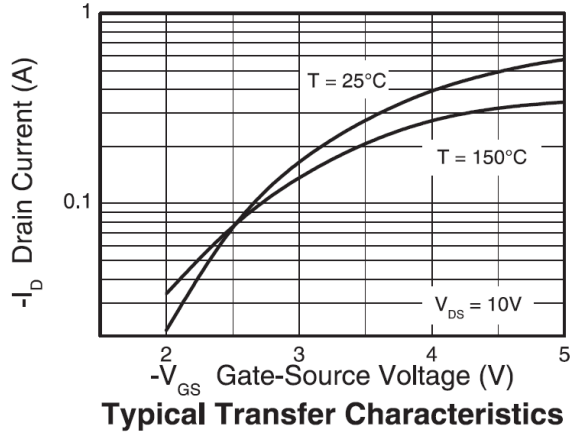
Output Characteristics

Output Characteristics

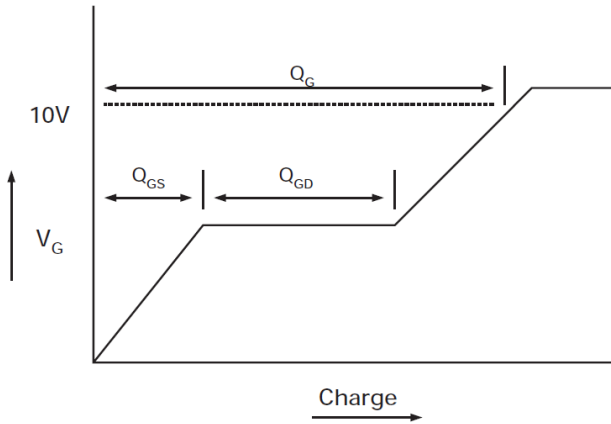

Test Circuits

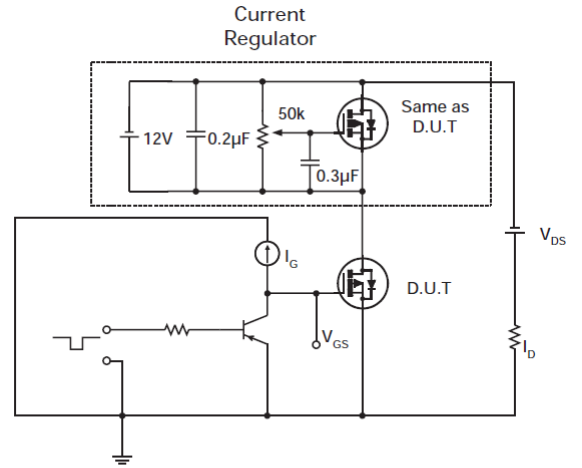

Basic Gate Charge Waveform



Gate Charge Test Circuit

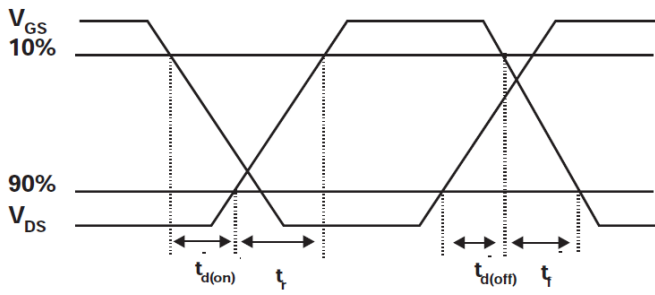

Switching Time Waveforms

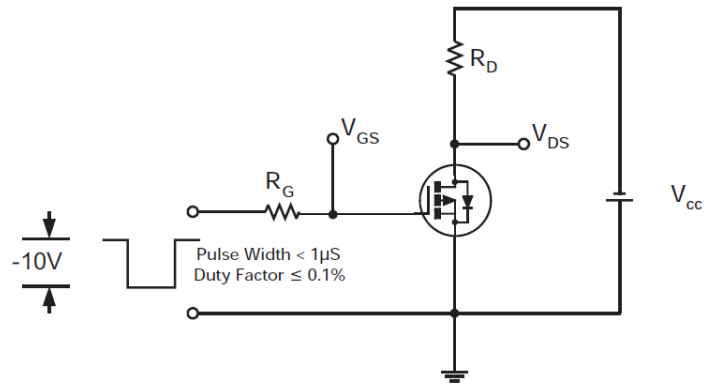

Switching Time Test Circuit

Package Outline Dimensions

Please see <http://www.diodes.com/package-outlines.html> for the latest version.

SOT223 (Type DN)

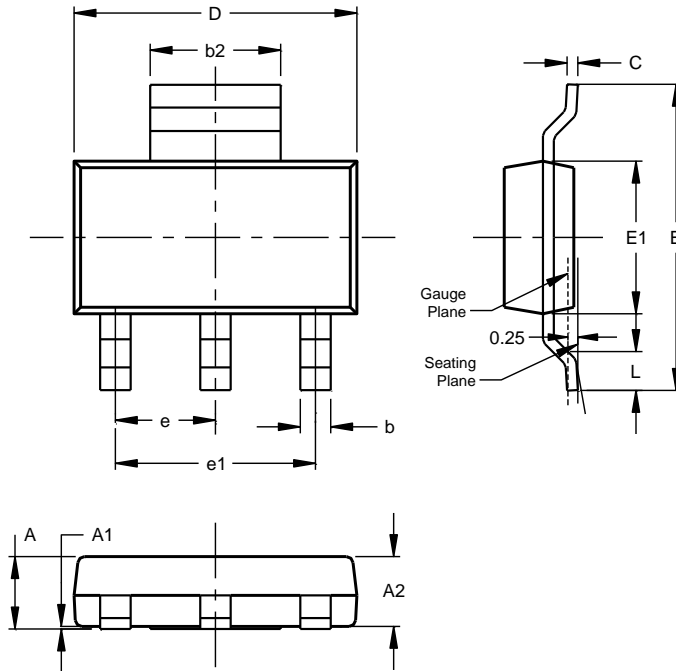

SOT223 (Type DN)			
Dim	Min	Max	Typ
A	--	1.70	--
A1	0.01	0.15	--
A2	1.50	1.68	1.60
b	0.60	0.80	0.70
b2	2.90	3.10	--
c	0.20	0.32	--
D	6.30	6.70	--
E	6.70	7.30	--
E1	3.30	3.70	--
e	--	--	2.30
e1	--	--	4.60
L	0.85	--	--
All Dimensions in mm			

Suggested Pad Layout

Please see <http://www.diodes.com/package-outlines.html> for the latest version.

SOT223 (Type DN)

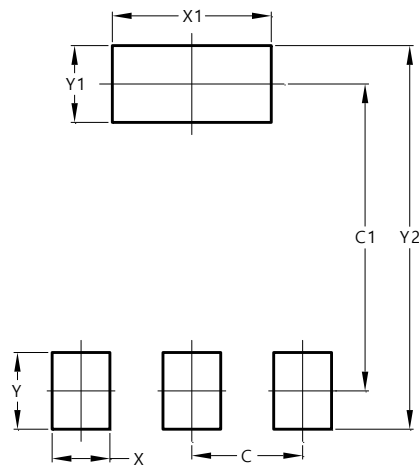

Dimensions	Value (in mm)
C	2.30
C1	6.40
X	1.20
X1	3.30
Y	1.60
Y1	1.60
Y2	8.00

IMPORTANT NOTICE

1. DIODES INCORPORATED AND ITS SUBSIDIARIES ("DIODES") MAKE NO WARRANTY OF ANY KIND, EXPRESS OR IMPLIED, WITH REGARDS TO ANY INFORMATION CONTAINED IN THIS DOCUMENT, INCLUDING, BUT NOT LIMITED TO, THE IMPLIED WARRANTIES OF MERCHANTABILITY, FITNESS FOR A PARTICULAR PURPOSE OR NON-INFRINGEMENT OF THIRD PARTY INTELLECTUAL PROPERTY RIGHTS (AND THEIR EQUIVALENTS UNDER THE LAWS OF ANY JURISDICTION).
2. The Information contained herein is for informational purpose only and is provided only to illustrate the operation of Diodes products described herein and application examples. Diodes does not assume any liability arising out of the application or use of this document or any product described herein. This document is intended for skilled and technically trained engineering customers and users who design with Diodes products. Diodes products may be used to facilitate safety-related applications; however, in all instances customers and users are responsible for (a) selecting the appropriate Diodes products for their applications, (b) evaluating the suitability of the Diodes products for their intended applications, (c) ensuring their applications, which incorporate Diodes products, comply the applicable legal and regulatory requirements as well as safety and functional-safety related standards, and (d) ensuring they design with appropriate safeguards (including testing, validation, quality control techniques, redundancy, malfunction prevention, and appropriate treatment for aging degradation) to minimize the risks associated with their applications.
3. Diodes assumes no liability for any application-related information, support, assistance or feedback that may be provided by Diodes from time to time. Any customer or user of this document or products described herein will assume all risks and liabilities associated with such use, and will hold Diodes and all companies whose products are represented herein or on Diodes' websites, harmless against all damages and liabilities.
4. Products described herein may be covered by one or more United States, international or foreign patents and pending patent applications. Product names and markings noted herein may also be covered by one or more United States, international or foreign trademarks and trademark applications. Diodes does not convey any license under any of its intellectual property rights or the rights of any third parties (including third parties whose products and services may be described in this document or on Diodes' website) under this document.
5. Diodes products are provided subject to Diodes' Standard Terms and Conditions of Sale (<https://www.diodes.com/about/company/terms-and-conditions/terms-and-conditions-of-sales/>) or other applicable terms. This document does not alter or expand the applicable warranties provided by Diodes. Diodes does not warrant or accept any liability whatsoever in respect of any products purchased through unauthorized sales channel.
6. Diodes products and technology may not be used for or incorporated into any products or systems whose manufacture, use or sale is prohibited under any applicable laws and regulations. Should customers or users use Diodes products in contravention of any applicable laws or regulations, or for any unintended or unauthorized application, customers and users will (a) be solely responsible for any damages, losses or penalties arising in connection therewith or as a result thereof, and (b) indemnify and hold Diodes and its representatives and agents harmless against any and all claims, damages, expenses, and attorney fees arising out of, directly or indirectly, any claim relating to any noncompliance with the applicable laws and regulations, as well as any unintended or unauthorized application.
7. While efforts have been made to ensure the information contained in this document is accurate, complete and current, it may contain technical inaccuracies, omissions and typographical errors. Diodes does not warrant that information contained in this document is error-free and Diodes is under no obligation to update or otherwise correct this information. Notwithstanding the foregoing, Diodes reserves the right to make modifications, enhancements, improvements, corrections or other changes without further notice to this document and any product described herein. This document is written in English but may be translated into multiple languages for reference. Only the English version of this document is the final and determinative format released by Diodes.
8. Any unauthorized copying, modification, distribution, transmission, display or other use of this document (or any portion hereof) is prohibited. Diodes assumes no responsibility for any losses incurred by the customers or users or any third parties arising from any such unauthorized use.

Copyright © 2021 Diodes Incorporated

www.diodes.com