



FEATURES

- Efficiency up to 88%
- Wide input range, 9V-36V
- Package Dimension:
Panel Mount:
100.0*56.0*19.0mm (3.94"* 2.20"*0.75")
Din Rail:
118.6*67.1*23.5mm (4.67"*2.64"*0.93")
- Over voltage protection, hiccup mode
- Over current protection, hiccup mode
- Positive or Negative Remote ON/OFF
- Without tantalum capacitor inside module
- Operating Temperature range - 40°C to +85°C
- Input to Output Isolation: 1600VDC
- RoHS Compliant
- 3 Years Product Warranty
- Heat-sink is option
- EN 50155 Certified for built-in module
- UL 60950-1 & CSA C22.2 No.60950-1-07 (pending)
- CE Marked (pending)



The DR24/PM24 family is designed particularly for industrial applications where no PCB mounting is possible the module has to be mounted on a panel or din-rail. the highest power density (30W), isolated power converter. The DR24/PM24 series comes with a host of industry-standard features, such as over current protection, over voltage protection, over temperature protection and remote on/off. All models have an ultra-wide 4:1 input voltage range (9V to 36V). With operating temperature of -40°C to +85°C, it is suitable for customers' critical applications, such as process control and automation, transportation, data communication and telecom equipment, test equipment, medical device and everywhere where space on the PCB is critical.

Model List

Model Number	Input Voltage (Range) VDC	Output Voltage VDC	Output Current		Input Current (typ input voltage)		Load Regulation mV	Maxcapacitive Load uF	Efficiency (typ.) %
			Max.	Min.	@Max. Load	@No Load			
			mA	mA	mA(typ.)	mA(typ.)			
PM24S05006 DR24S05006	24 (9 ~ 36)	5.0V	6000	0	1450	55	±10	10000	88%
PM24S12003 DR24S12003		12V	2500	0	1450	20	±12	1000	88%
PM24S15002 DR24S15002		15V	2000	0	1450	20	±15	1000	88%
PM24D12001 DR24D12001		±12V	1250	0	1450	25	±120	±680	88%
PM24D15001 DR24D15001		±15V	1000	0	1450	25	±150	±330	88%

Input Characteristics

Item	Model	Min.	Typ.	Max.	Unit
Input Surge Voltage (100 msec)	All Models			50	VDC
Input Turn-On Voltage Threshold	All Models	8	8.5	9	VDC
Input Turn-Off Voltage Threshold	All Models	7.2	7.5	8.2	VDC
Input Under-Voltage Lockout Hysteresis	All Models	0.2	1	1.5	VDC
Off-Converter Input Current	All Models		12		mA
Reverse Polarity Input Current	All Models	---	---	0.1	A
ON/OFF Control, Logic High	All Models	2.4		10	VDC
ON/OFF Control, Logic Low	All Models	-0.7		0.8	VDC

Output Characteristics					
Item	Conditions	Min.	Typ.	Max.	Unit
Output Voltage Accuracy		---	±1.0	±2.0	%Vo
Output Voltage Balance	Dual Output, Balanced Loads	---	±1.0	±2.0	%Vo
Line Regulation	Single output		±0.1	±0.2	%Vo
	Dual output		±0.1	±0.5	%Vo
Cross Regulation	Dual output, Asymmetrical Load 25%-100% Full Load		±2	±3	%Vo
Total Output Voltage Range	Over Load, Line and Temperature	---	---	±3	%Vo
Ripple & Noise	All Models	---	3	---	mV _{P-P}
Dynamic load response	50%-75% full load, 0.1A/uS		3		%Vo
Output Over Current Protection	Output Voltage 10% Low, Hiccup	110		160	%Io,max
Short Output Protection	Long Term, Auto-recovery				
Output Over-Voltage Protection	Hiccup, Auto-recovery	115		150	%Vo
Output Trim Range	Single Output	-10		+10	%Vo

General Characteristics					
Item	Conditions	Min.	Typ.	Max.	Unit
I/O Isolation Voltage (rated)		---	---	1600	VDC
I/O Isolation Resistance		10	---	---	MΩ
I/O Isolation Capacitance			2600		pF
Switching Frequency			550		KHz

Environmental Specifications					
Parameter	Model	Conditions	Min.	Max.	Unit
Operating Temperature Range (with Derating)	All Models	Ambient	-40	+85	°C
Case Temperature	All Models		---	+100	°C
Storage Temperature Range	PM series		-40	+85	°C
	DR series		-40	+100	°C
Humidity (non condensing)	All Models		---	95	% rel. H
Altitude	All Models			2000	m
Cooling	All Models	Free-Air convection			

EMC Specifications		
Parameter	Standards & Level	Performance
EMI	EN55022 ClassB	compliance
ESD	EN61000-4-2 air ± 8KV , Contact ± 6KV Perf. Criteria B	compliance
Radiated immunity	EN61000-4-3 20V/m Perf. Criteria A	compliance
Fast transient (See Note 5)	EN61000-4-4 ±2KV Perf. Criteria A	compliance
Surge (See Note 5)	EN61000-4-5 ±1KV Perf. Criteria A	compliance
Conducted immunity	EN61000-4-6 10V/m Perf. Criteria A	compliance

ELECTRICAL CHARACTERISTICS CURVES – PM/DR24S05006, 9-36VIN, 5V/6A

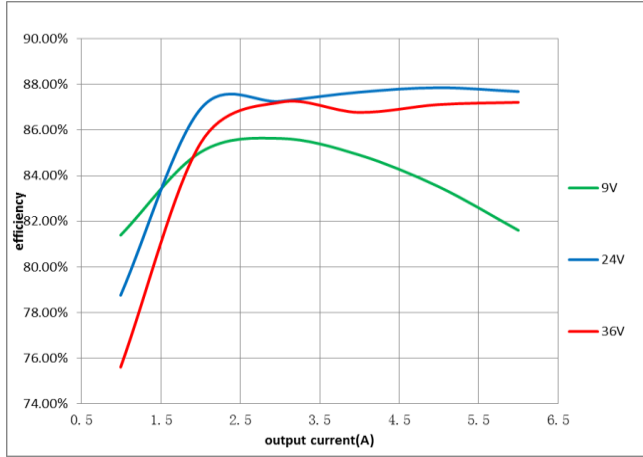

Efficiency vs. load current for various input voltage at 25°C.

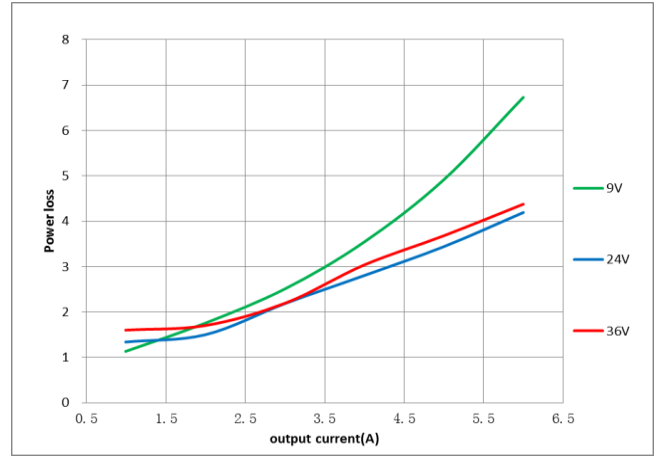

Power dissipation vs. load current at 25°C .

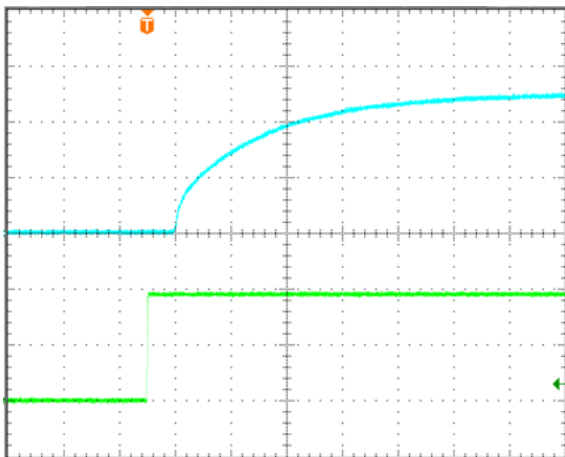

Turn-on transient at full load current (10ms/div).
Top Trace: Vout; 2V/div; Bottom Trace: ON/OFF input: 5V/div.

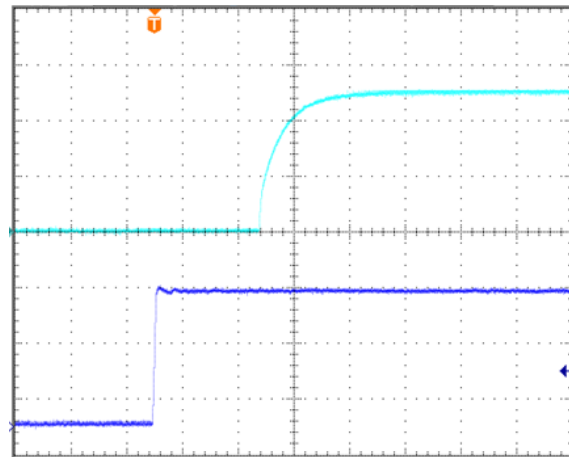

Turn-on transient at full load current (40ms/div).
Top Trace: Vout; 2V/div; Bottom Trace: input voltage: 10V/div.

ELECTRICAL CHARACTERISTICS CURVES – PM/DR24S12003, 9-36VIN, 12V/2.5A

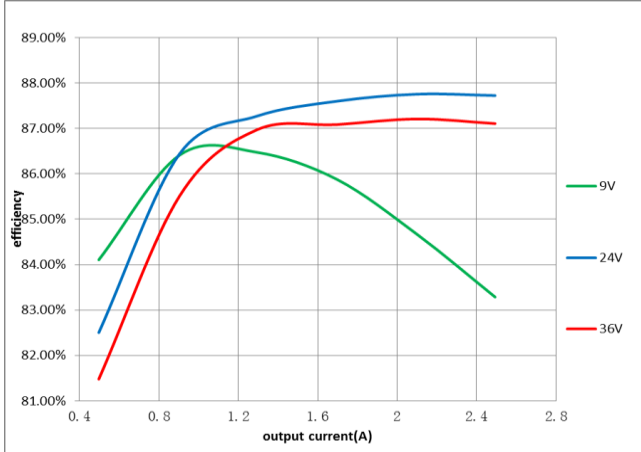

Efficiency vs. load current for various input voltage at 25°C.

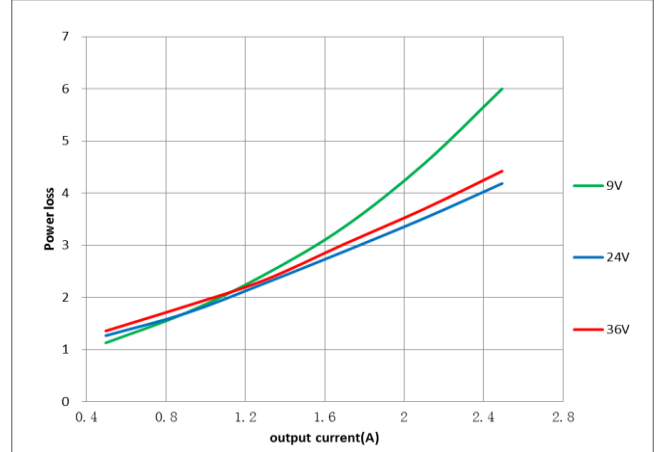

Power loss vs. load current at 25°C .

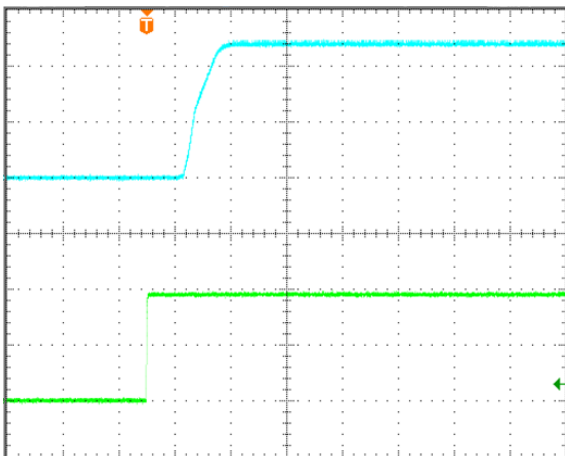

Turn-on transient at full load current (10ms/div).
Top Trace: Vout; 5V/div; Bottom Trace: ON/OFF input: 5V/div.

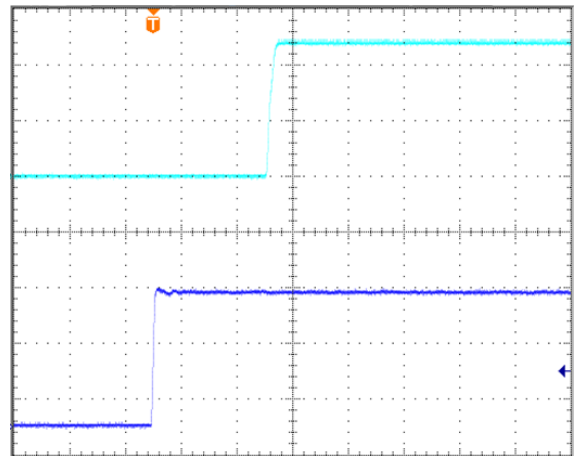

Turn-on transient at full load current (40ms/div).
Top Trace: Vout; 5V/div; Bottom Trace: input voltage: 10V/div.

ELECTRICAL CHARACTERISTICS CURVES – PM/DR24S15002, 9-36VIN, 15V/2A

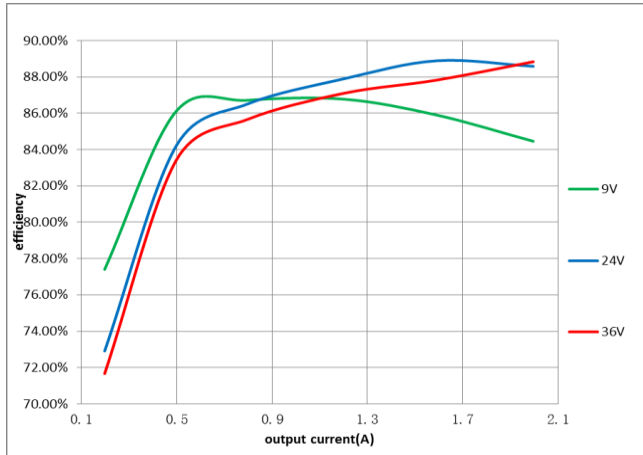

Efficiency vs. load current for various input voltage at 25°C.

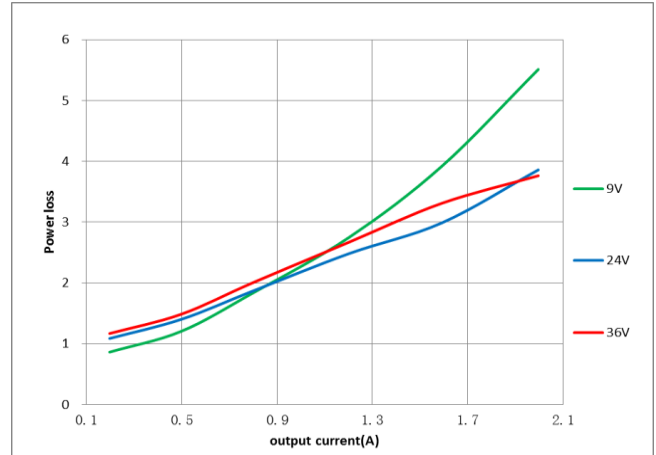

Power dissipation vs. load current at 25°C.

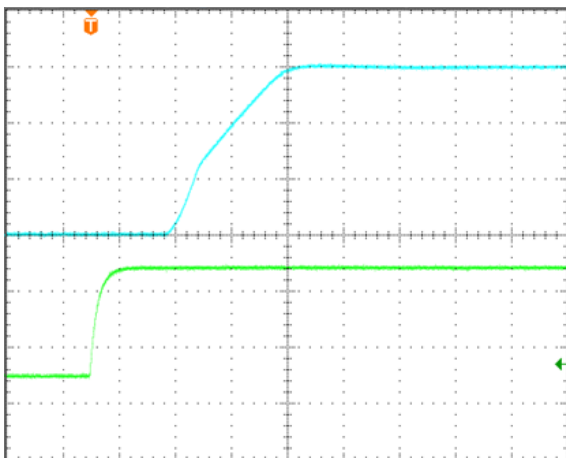

Turn-on transient at full load current (4ms/div).
Top Trace: Vout; 5V/div; Bottom Trace: ON/OFF input: 5V/div.

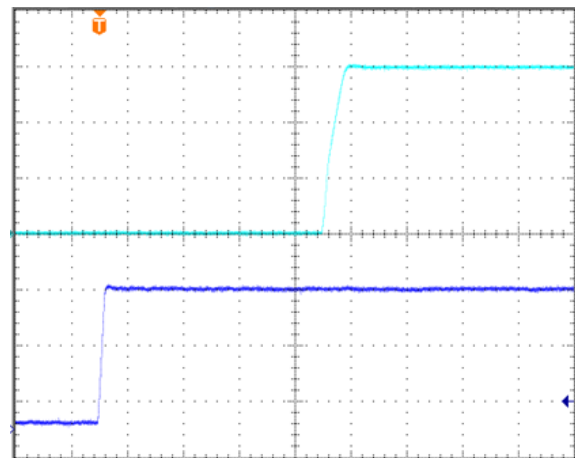

Turn-on transient at full load current (20ms/div).
Top Trace: Vout; 5V/div; Bottom Trace: input voltage: 10V/div.

ELECTRICAL CHARACTERISTICS CURVES – PM/DR24D12001, 9-36VIN, ±12V/1.25A

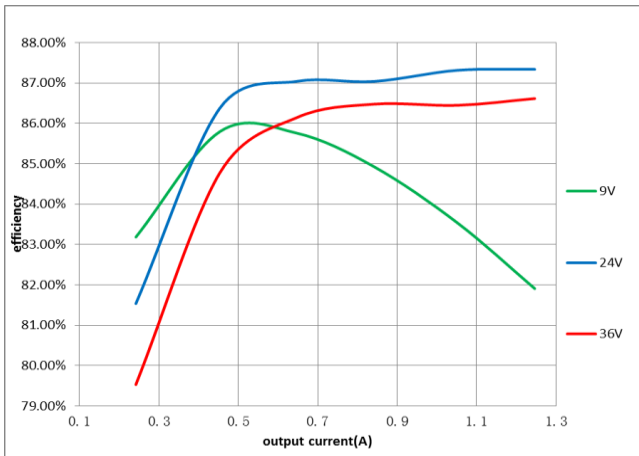

Efficiency vs. load current for various input voltage at 25°C.

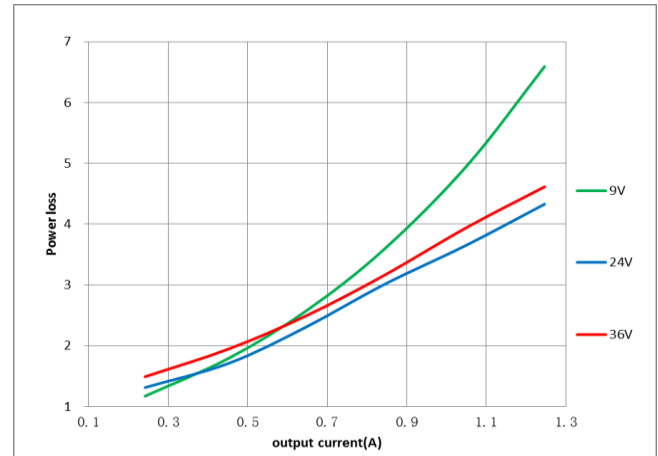

Power dissipation vs. load current at 25°C.

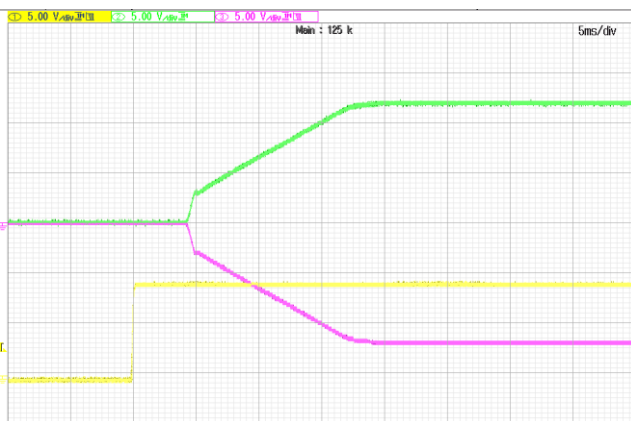

Turn-on transient at full load current (5ms/div).
Top two Traces: Vout; 5V/div; Bottom Trace: ON/OFF input: 5V/div.

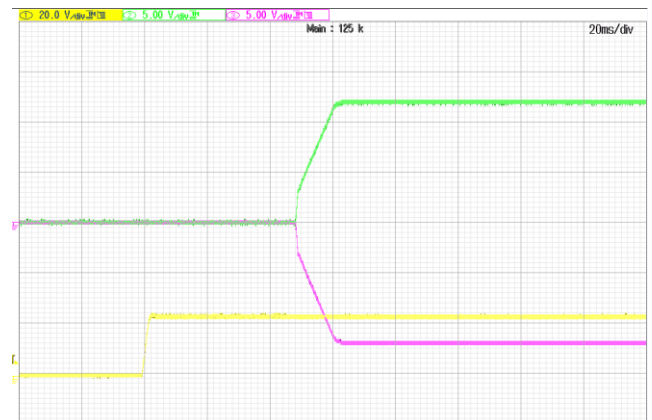

Turn-on transient at full load current (20ms/div).
Top two Traces: Vout; 5V/div; Bottom Trace: input voltage: 20V/div.

ELECTRICAL CHARACTERISTICS CURVES – PM/DR24D15001, 9-36VIN, ±15V/1.0A

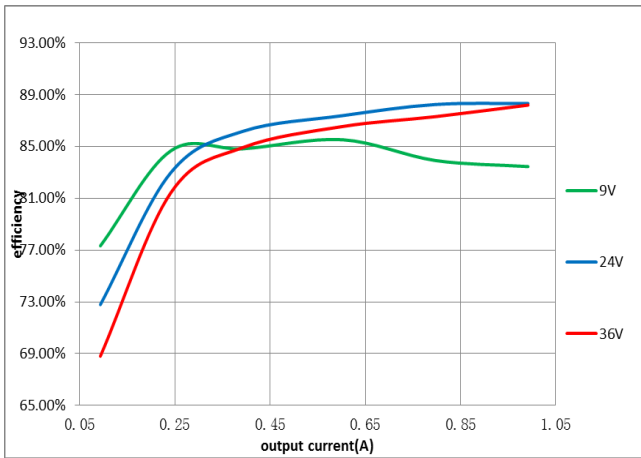

Efficiency vs. load current for various input voltage at 25°C.

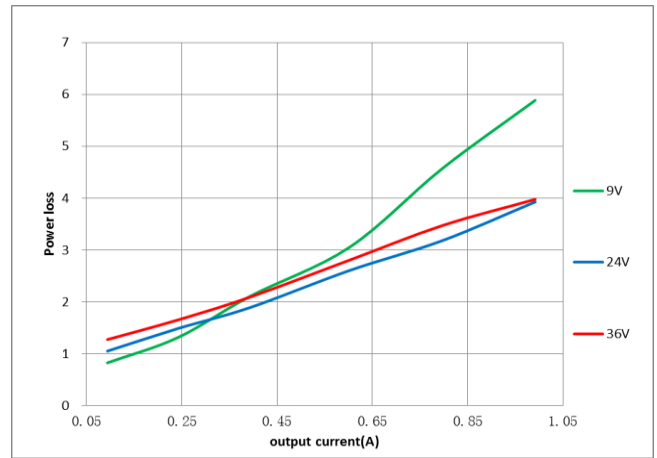

Power dissipation vs. load current at 25°C.

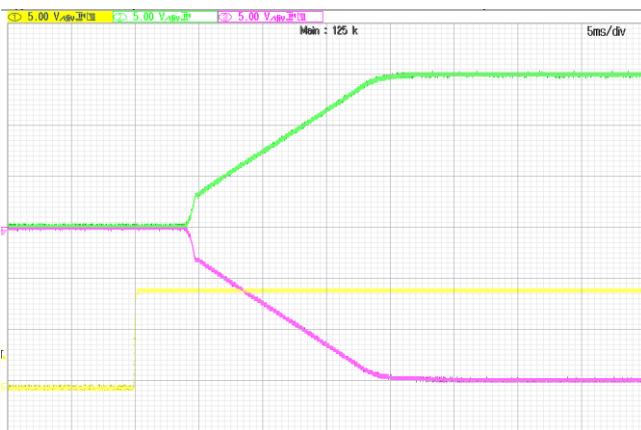

Turn-on transient at full load current (5ms/div).
Top two traces: Vout; 5V/div; Bottom Trace: ON/OFF input: 5V/div.

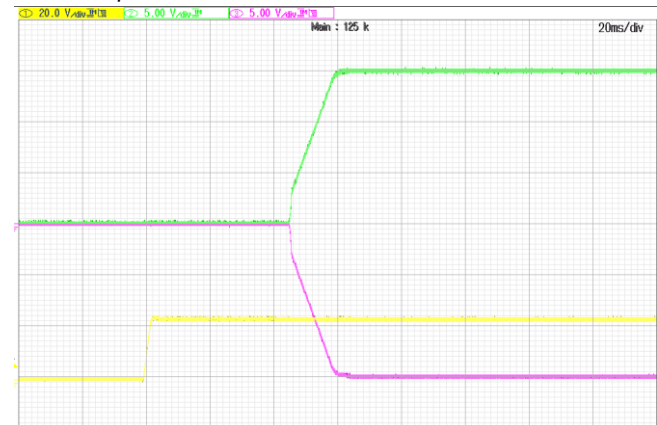

Turn-on transient at full load current (20ms/div).
Top two traces: Vout; 5V/div; Bottom Trace: input voltage: 20V/div.

FEATURES DESCRIPTIONS

Over-Current Protection

The modules include an internal output over-current protection circuit, which will endure current limiting for an unlimited duration during output overload. If the output current exceeds the OCP set point, the modules will shut down (hiccup mode).

The modules will try to restart after shutdown. If the overload condition still exists, the module will shut down again. This restart trial will continue until the overload condition is corrected.

Over-Voltage Protection

The modules include an internal output over-voltage protection circuit, which monitors the voltage on the output terminals. If this voltage exceeds the over-voltage set point, the modules will shut down, and then restart after a hiccup-time (hiccup mode).

If latch mode is needed, please contact with Delta.

Over-Temperature Protection

The over-temperature protection consists of circuitry that provides protection from thermal damage. If the temperature exceeds the over-temperature threshold the module will shut down. The module will restart after the temperature is within specification.

Remote On/Off

The remote on/off feature on the module can be either negative or positive logic depend on the part number options on the last page.

- ❖ For Negative logic version, turns the module on during a external logic low and off during a logic high. If the remote on/off feature is not used, please short the on/off pin to Vi (-).
- ❖ For Postive logic version, turns the modules on during a external logic high and off during a logic low. If the remote on/off feature is not used, please leave the on/off pin to floating.

Remote on/off can be controlled by an external switch between the on/off terminal and the Vi (-) terminal. The switch can be an open collector or open drain.

Output Voltage Adjustment (TRIM)

Turn potentiometer on front panel: clockwise to increase voltage value; counter clockwise to decrease voltage value. (only for single output modules)

THERMAL CONSIDERATIONS

To enhance system reliability, the power module's case temperature should always be operated below 105°C. If the case temperature exceeds the maximum operating temperature, reliability of the unit may be affected.

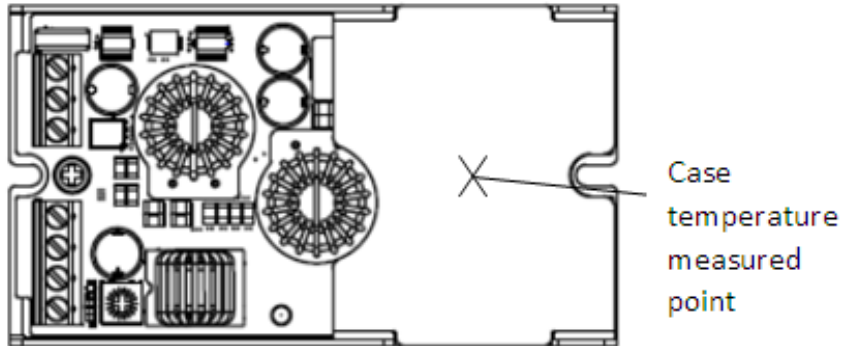

THERMAL CURVES

The module is tested in the temperature chamber under natural convection.

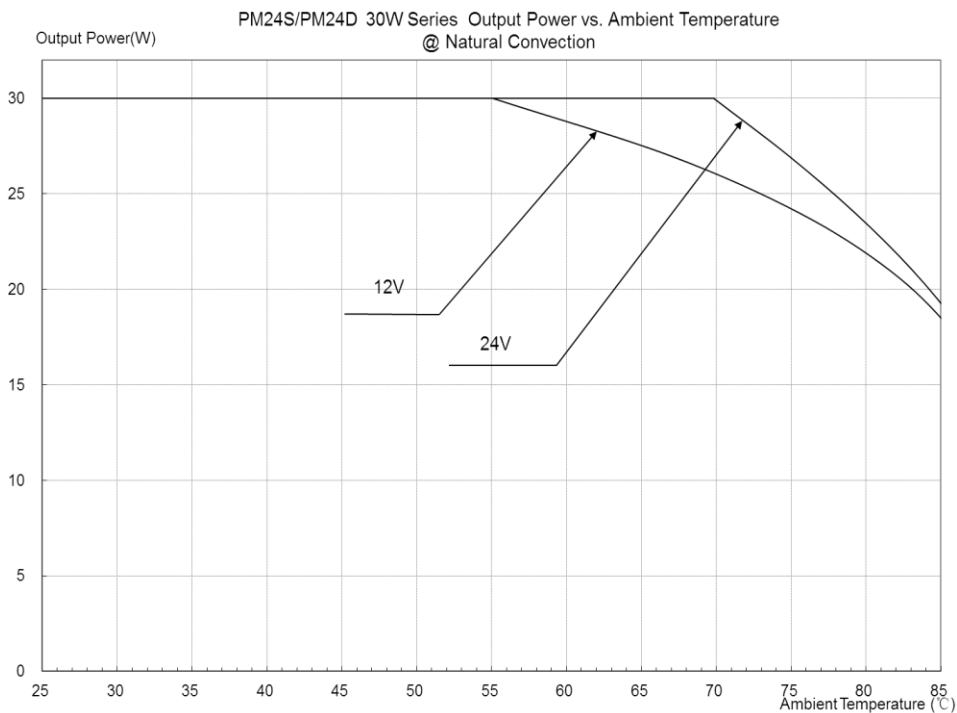
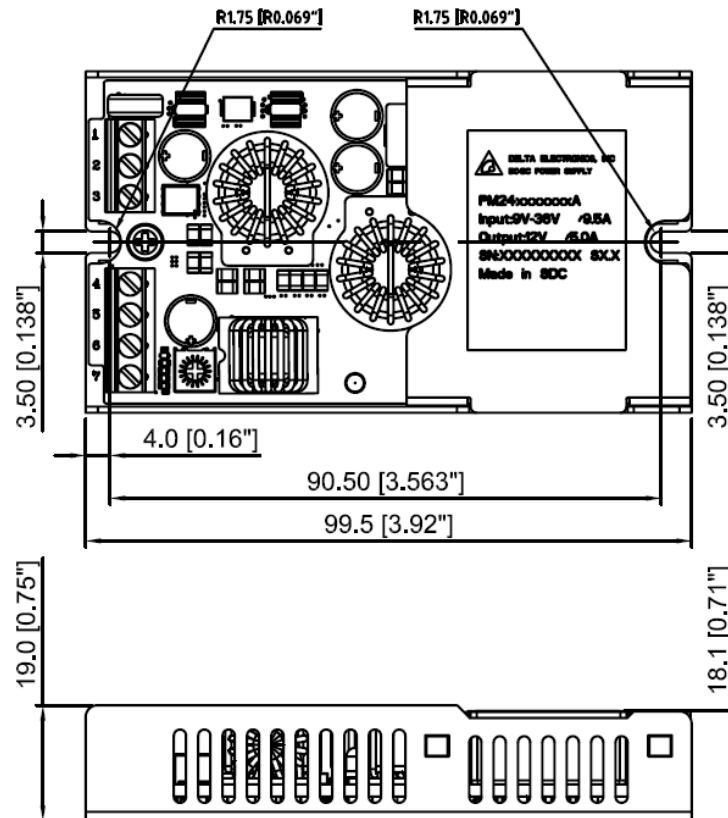

Figure1: PM24S/PM24D 30W series Output power vs Ambient temperature@Natural convection

Mechanical Drawing (Panel-mount Package)

Mechanical Dimensions



Pin Connections		
Pin	Function for Single Output model	Function for Dual Output model
1	Vin+	Vin+
2	Vin-	Vin-
3	On/off	On/off
4	Vout-	Vout-
5	Vout-	Common
6	Vout+	Vout+
7	Vout+	NC

Product Size: 100.0*56.0*19.0(3.94** 2.20**0.75")

Case material: Aluminum alloy

Baseplate material: Aluminum alloy

Input terminal: M3 Screw Terminal

Input wire range: 28~16 AWG

Output Terminal: M3 Screw Terminal

Output wire range: 28~16 AWG

Weight: 104 grams

- All dimensions in mm (inches)
- Tolerance: X.X±0.5 (X.XX±0.02)
X.XX±0.25 (X.XXX±0.010)

Mechanical Drawing (Din-rail Package)

Mechanical Dimensions

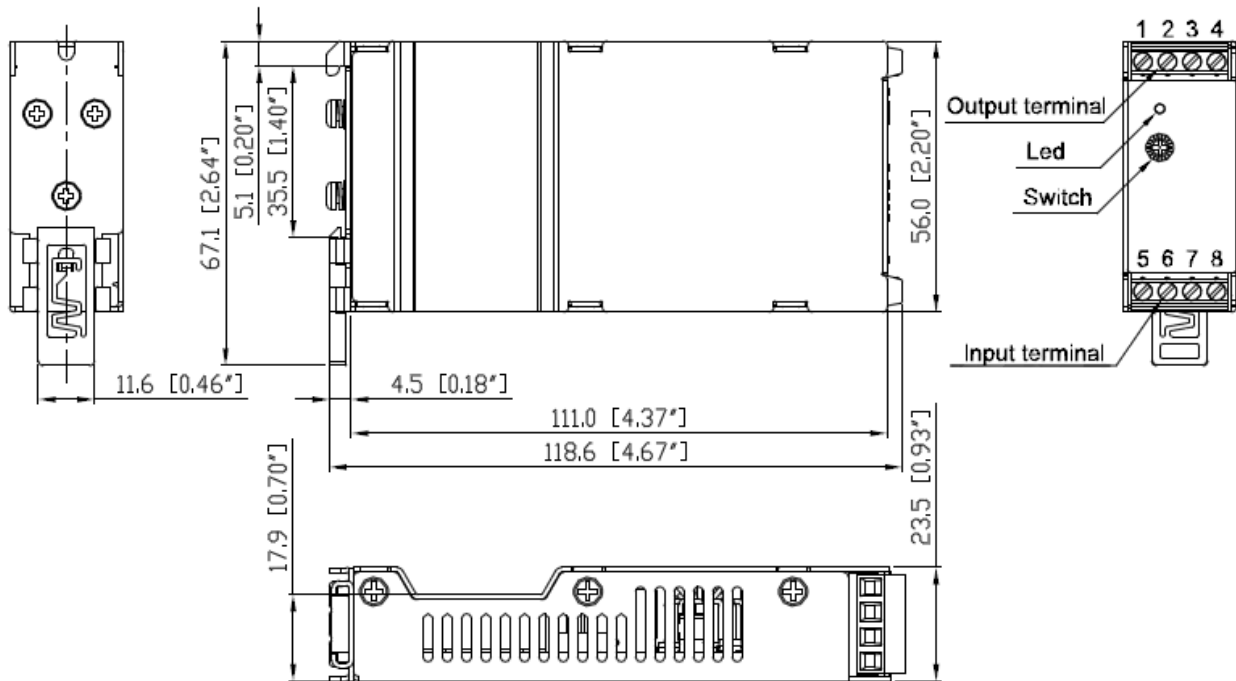

Pin Connections		
Pin	Function for Single Output model	Function for Dual Output model
1	Vout-	NC
2	Vout-	Vout-
3	Vout+	COM
4	Vout+	Vout+
5	On/off	On/off
6	Vin-	Vin-
7	Vin-	Vin-
8	Vin+	Vin+

Physical outline

Product Size: 118.6*67.1*23.5(4.67"*2.64"*0.93")

Case material: Aluminum alloy

Baseplate material: Aluminum alloy

Input terminal: M3 Screw Terminal

Input wire range: 28~16 AWG

Output Terminal: M3 Screw Terminal

Output wire range: 28~16 AWG

Weight: 135 grams

- All dimensions in mm (inches)
- Tolerance: X.X±0.5 (X.XX±0.02)
X.XX±0.25 (X.XXX±0.010)

Part Numbering System

PM	24	S	050	06	N	A	F	A
Form factor	Input voltage	Number of output	Output voltage	Output current	On/off logic	Terminal Type	RoHS	Option Code
PM-panle mount	24 – 9~36V	S - Single D - Dual	050-5V	06 - 6A	N - Negative P - Positive	A- Screw terminal	F - RoHS 6/6 (Lead Free)	A: With EMI filter

DR	24	S	240	08	P	A	F	A
Form factor	Input voltage	Number of output	Output voltage	Output current	On/off logic	Terminal Type	RoHS	Option Code
DR-Din-rail Mount	24 – 9~36V	S – Single D - Dual	240-24V	08 - 8A	N - Negative P - Positive	A- Screw terminal	F - RoHS 6/6 (Lead Free)	A: With EMI filter

CONTACT: www.deltaww.com/dcdc

Email: dcdc@deltaww.com

USA:

Telephone:
East Coast: 978-656-3993
West Coast: 510-668-5100
Fax: (978) 656 3964

Europe:

Phone: +31-20-655-0967
Fax: +31-20-655-0999

Asia & the rest of world:

Telephone: +886 3 4526107
ext 6220~6224
Fax: +886 3 4513485

WARRANTY

Delta offers a three (3) years limited warranty. Complete warranty information is listed on our web site or is available upon request from Delta.

Information furnished by Delta is believed to be accurate and reliable. However, no responsibility is assumed by Delta for its use, nor for any infringements of patents or other rights of third parties, which may result from its use. No license is granted by implication or otherwise under any patent or patent rights of Delta. Delta reserves the right to revise these specifications at any time, without notice.