

Low Cost 3.3V Spread Aware Zero Delay Buffer

Features

- 10 MHz to 100 and 133 MHz Operating Range, compatible with CPU and PCI bus frequencies
- Zero Input-output Propagation Delay
- Multiple Low Skew Outputs
 - Output-output skew less than 250 ps
 - Device-device skew less than 700 ps
 - One input drives five outputs (CY23S05)
 - One input drives nine outputs, grouped as 4 + 4 + 1 (CY23S09)
- Less than 200 ps Cycle-to-cycle jitter is compatible with Pentium based systems
- Test mode to bypass PLL (CY23S09 only, see [Select Input Decoding for CY23S09](#) on page 2)
- Available in space saving 16-pin, 150-mil SOIC, 4.4 mm TSSOP, and 150-mil SSOP (CY23S09) or 8-pin, 150-mil SOIC package (CY23S05)
- 3.3V operation, advanced 0.65 μ CMOS Technology
- Spread Aware

Functional Description

The CY23S09 is a low cost 3.3V zero delay buffer designed to distribute high speed clocks and is available in a 16-pin SOIC package. The CY23S05 is an 8-pin version of the CY23S09. It accepts one reference input, and drives out five low skew clocks. The -1H versions of each device operate at up to 100 and 133

MHz frequencies and have higher drive than the -1 devices. All parts have on-chip PLLs that lock to an input clock on the REF pin. The PLL feedback is on-chip and is obtained from the CLKOUT pad.

The CY23S09 has two banks of four outputs each, which can be controlled by the select inputs as shown in the Select Input Decoding table on [Select Input Decoding for CY23S09](#) on page 2. If all output clocks are not required, Bank B can be three-stated. The select inputs also allow the input clock to be directly applied to the outputs for chip and system testing purposes.

The CY23S09 and CY23S05 PLLs enter a power down mode when there are no rising edges on the REF input. In this state, the outputs are three-stated and the PLL is turned off, resulting in less than 12.0 μ A of current draw (for commercial temperature devices) and 25.0 μ A (for industrial temperature devices). The CY23S09 PLL shuts down in one additional case, as shown in the [Select Input Decoding for CY23S09](#) on page 2.

Multiple CY23S09 and CY23S05 devices can accept the same input clock and distribute it. In this case, the skew between the outputs of two devices is guaranteed to be less than 700 ps.

All outputs have less than 200 ps of cycle-to-cycle jitter. The input to output propagation delay on both devices is guaranteed to be less than 350 ps; the output to output skew is guaranteed to be less than 250 ps.

The CY23S05 and CY23S09 is available in two different configurations, as shown in the [Ordering Information](#) on page 6. The CY23S05-1 and CY23S09-1 is the base part. The CY23S05-1H and CY23S09-1H is the high drive version of the -1, and its rise and fall times are much faster than -1.

Logic Block Diagram

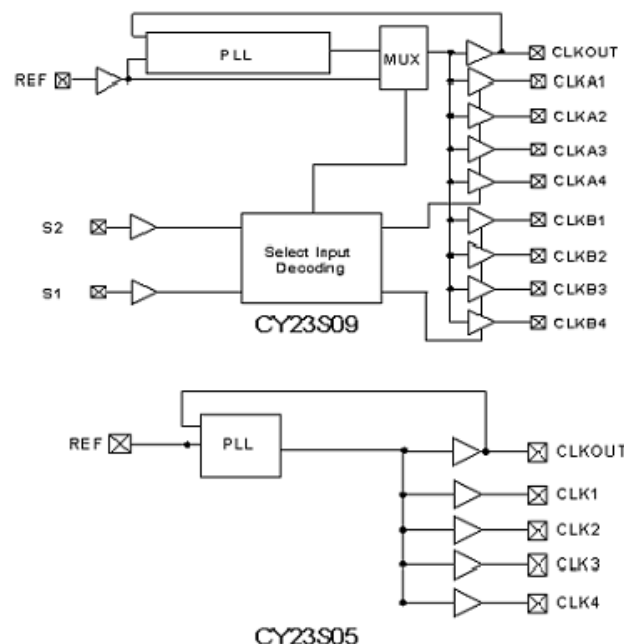

Select Input Decoding for CY23S09

S2	S1	CLOCK A1–A4	CLOCK B1–B4	CLKOUT ^[1]	Output Source	PLL Shutdown
0	0	Three-state	Three-state	Driven	PLL	N
0	1	Driven	Three-state	Driven	PLL	N
1	0	Driven	Driven	Driven	Reference	Y
1	1	Driven	Driven	Driven	PLL	N

Zero Delay and Skew Control

All outputs must be uniformly loaded to achieve Zero Delay between the input and output. Because the CLKOUT pin is the internal feedback to the PLL, its relative loading can adjust the input-output delay. This is shown in the above graph.

For applications requiring zero input-output delay, all outputs, including CLKOUT, must be equally loaded. Even if CLKOUT is not used, it must have a capacitive load equal to that on other outputs, to obtain zero input-output delay. If input to output delay adjustments are required, use the above graph to calculate loading differences between the CLKOUT pin and other outputs.

For zero output-output skew, be sure to load all outputs equally. For further information, refer to the application note “CY23S05 and CY23S09 as PCI and SDRAM Buffers.”

Spread Aware

Many systems being designed now use a technology called Spread Spectrum Frequency Timing Generation. Cypress is one of the pioneers of SSFTG development and designed this product so as not to filter off the Spread Spectrum feature of the Reference input, assuming it exists. When a zero delay buffer is not designed to pass the SS feature through, the result is a significant amount of tracking skew, which may cause problems in systems requiring synchronization.

For more details on Spread Spectrum timing technology, please see the Cypress application note [AN1278, EMI Suppression Techniques with Spread Spectrum Frequency Timing Generator \(SSFTG\) ICs](#).

Pinouts

Figure 1. Pin Configuration – CY23S09

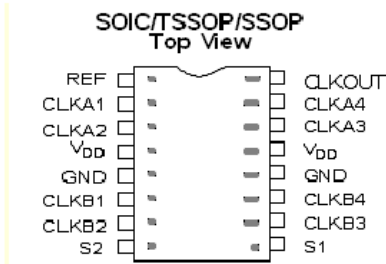
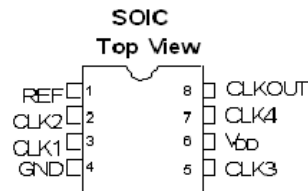

Figure 2. Pin Configuration – CY23S05



Note

1. This output is driven and has an internal feedback for the PLL. The load on this output can be adjusted to change the skew between the reference and output.

Table 1. Pin Description for CY23S09

Pin	Signal	Description
1	REF ^[2]	Input reference frequency, 5V tolerant input
2	CLKA1 ^[3]	Buffered clock output, bank A
3	CLKA2 ^[3]	Buffered clock output, bank A
4	V _{DD}	3.3V supply
5	GND	Ground
6	CLKB1 ^[3]	Buffered clock output, bank B
7	CLKB2 ^[3]	Buffered clock output, bank B
8	S2 ^[4]	Select input, bit 2
9	S1 ^[4]	Select input, bit 1
10	CLKB3 ^[3]	Buffered clock output, bank B
11	CLKB4 ^[3]	Buffered clock output, bank B
12	GND	Ground
13	V _{DD}	3.3V supply
14	CLKA3 ^[3]	Buffered clock output, bank A
15	CLKA4 ^[3]	Buffered clock output, bank A
16	CLKOUT ^[3]	Buffered output, internal feedback on this pin

Table 2. Pin Description for CY23S05

Pin	Signal	Description
1	REF ^[2]	Input reference frequency, 5V tolerant input
2	CLK2 ^[3]	Buffered clock output
3	CLK1 ^[3]	Buffered clock output
4	GND	Ground
5	CLK3 ^[3]	Buffered clock output
6	V _{DD}	3.3V supply
7	CLK4 ^[3]	Buffered clock output
8	CLKOUT ^[3]	Buffered clock output, internal feedback on this pin

Notes

2. Weak pull down.
3. Weak pull down on all outputs.
4. Weak pull up on these inputs.

Maximum Ratings

Supply Voltage to Ground Potential.....	-0.5V to +7.0V	Maximum Soldering Temperature (10 seconds).....	260°C
DC Input Voltage (Except REF)	-0.5V to $V_{DD} + 0.5V$	Junction Temperature	150°C
DC Input Voltage REF	-0.5V to 7V	Static Discharge Voltage	
Storage Temperature	-65°C to +150°C	(per MIL-STD-883, Method 3015)	> 2,000V

Operating Conditions for CY23S05SC-XX and CY23S09SC-XX Commercial Temperature Devices^[5]

Parameter	Description	Min	Max	Unit
V_{DD}	Supply Voltage	3.0	3.6	V
T_A	Operating Temperature (Ambient Temperature)	0	70	°C
C_L	Load Capacitance, below 100 MHz		30	pF
C_L	Load Capacitance, from 100 MHz to 133 MHz		10	pF
C_{IN}	Input Capacitance		7	pF

Electrical Characteristics for CY23S05SC-XX and CY23S09SC-XX Commercial Temperature Devices

Parameter	Description	Test Conditions	Min	Max	Unit
V_{IL}	Input LOW Voltage ^[6]			0.8	V
V_{IH}	Input HIGH Voltage ^[6]		2.0		V
I_{IL}	Input LOW Current	$V_{IN} = 0V$		50.0	μA
I_{IH}	Input HIGH Current	$V_{IN} = V_{DD}$		100.0	μA
V_{OL}	Output LOW Voltage ^[7]	$I_{OL} = 8\text{ mA} (-1)$ $I_{OH} = 12\text{ mA} (-1H)$		0.4	V
V_{OH}	Output HIGH Voltage ^[7]	$I_{OH} = -8\text{ mA} (-1)$ $I_{OL} = -12\text{ mA} (-1H)$	2.4		V
I_{DD} (PD mode)	Power Down Supply Current	REF = 0 MHz		12.0	μA
I_{DD}	Supply Current	Unloaded outputs at 66.67 MHz, SEL inputs at V_{DD}		32.0	mA

Switching Characteristics for CY23S05SC-1 and CY23S09SC-1 Commercial Temperature Devices^[8]

Parameter	Description	Test Conditions	Min	Typ	Max	Unit
t_1	Output Frequency	30 pF load 10 pF load	10 10		100 133.33	MHz MHz
	Duty Cycle ^[7] = $t_2 \div t_1$	Measured at 1.4V, $F_{out} = 66.67\text{ MHz}$	40.0	50.0	60.0	%
t_3	Rise Time ^[7]	Measured between 0.8V and 2.0V			2.50	ns
t_4	Fall Time ^[7]	Measured between 0.8V and 2.0V			2.50	ns
t_5	Output-to-Output Skew ^[7]	All outputs equally loaded			250	ps
t_6	Delay, REF Rising Edge to CLKOUT Rising Edge ^[7]	Measured at $V_{DD}/2$		0	±350	ps
t_7	Device-to-Device Skew ^[7]	Measured at $V_{DD}/2$ on the CLKOUT pins of devices		0	700	ps
t_J	Cycle-to-Cycle Jitter ^[7]	Measured at 66.67 MHz, loaded outputs			200	ps
t_{LOCK}	PLL Lock Time ^[7]	Stable power supply, valid clock presented on REF pin			1.0	ms

Notes

- Multiple Supplies: The voltage on any input or I/O pin cannot exceed the power pin during power up. Power supply sequencing is NOT required.
- REF input has a threshold voltage of $V_{DD}/2$.
- Parameter is guaranteed by design and characterization. Not 100% tested in production.
- All parameters specified with loaded outputs.

Switching Characteristics for CY23S05SI-1H and CY23S09SI-1H Industrial Temperature Devices^[8]

Parameter	Description	Test Conditions	Min	Typ	Max	Unit
t1	Output Frequency	30 pF load 10 pF load	10 10		100 133.33	MHz MHz
	Duty Cycle ^[7] = $t_2 \div t_1$	Measured at 1.4V, $F_{out} = 66.67$ MHz	40.0	50.0	60.0	%
	Duty Cycle ^[7] = $t_2 \div t_1$	Measured at 1.4V, $F_{out} < 50.0$ MHz	45.0	50.0	55.0	%
t3	Rise Time ^[7]	Measured between 0.8V and 2.0V			1.50	ns
t4	Fall Time ^[7]	Measured between 0.8V and 2.0V			1.50	ns
t5	Output-to-Output Skew ^[7]	All outputs equally loaded			250	ps
t6	Delay, REF Rising Edge to CLKOUT Rising Edge ^[7]	Measured at $V_{DD}/2$		0	± 350	ps
t7	Device-to-Device Skew ^[7]	Measured at $V_{DD}/2$ on the CLKOUT pins of devices		0	700	ps
t8	Output Slew Rate ^[7]	Measured between 0.8V and 2.0V using Test Circuit #2	1			V/ns
t _J	Cycle-to-Cycle Jitter ^[7]	Measured at 66.67 MHz, loaded outputs			200	ps
t _{LOCK}	PLL Lock Time ^[7]	Stable power supply, valid clock presented on REF pin			1.0	ms

Switching Waveforms

Figure 3. Duty Cycle Timing

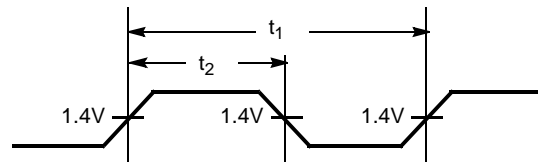

Figure 4. All Outputs Rise/Fall Time

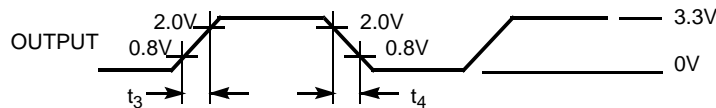

Figure 5. Output-Output Skew

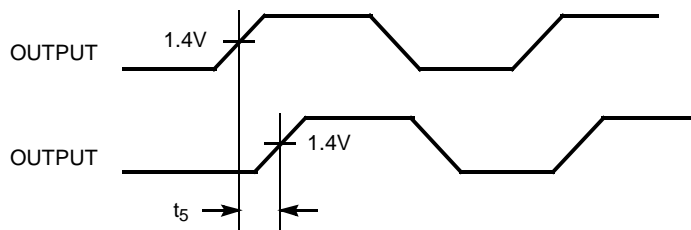
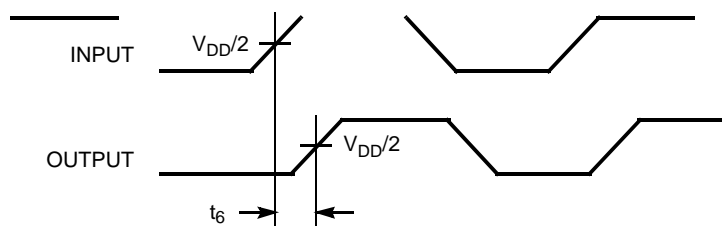
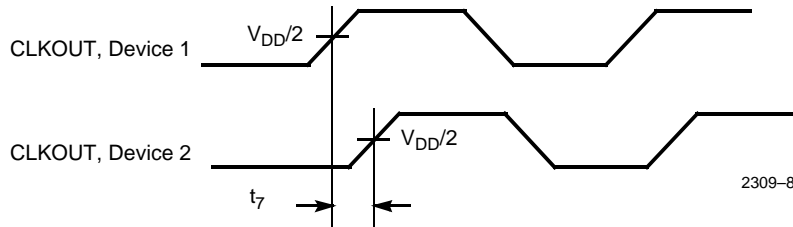

Figure 6. Input-Output Propagation Delay



Switching Waveforms continued

Figure 7. Device-Device Skew



Test Circuits

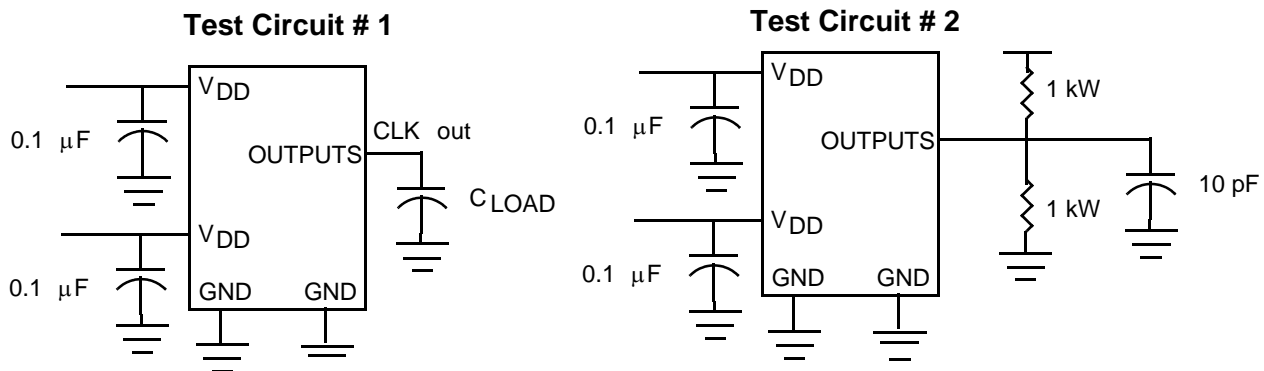

For parameter t8 (output slew rate) on -1H devices

Ordering Information

Ordering Code	Package Name	Package Type	Operating Range
CY23S05SC-1 ^[9]	S08	8-pin 150-mil SOIC	Commercial (0° to 70°C)
CY23S05SC-1H ^[9]	S08	8-pin 150-mil SOIC	Commercial (0° to 70°C)
CY23S09SC-1 ^[9]	S16	16-pin 150-mil SOIC	Commercial (0° to 70°C)
CY23S09SC-1H ^[9]	S16	16-pin 150-mil SOIC	Commercial (0° to 70°C)
CY23S09ZC-1H ^[9]	Z16	16-pin 4.4 mm TSSOP	Commercial (0° to 70°C)
Pb-Free			
CY23S05SXC-1	SZ08	8-pin 150-mil SOIC	Commercial (0° to 70°C)
CY23S05SXC-1T	SZ08	8-pin 150-mil SOIC – Tape and Reel	Commercial (0° to 70°C)
CY23S05SXC-1H	SZ08	8-pin 150-mil SOIC	Commercial (0° to 70°C)
CY23S05SXC-1HT	SZ08	8-pin 150-mil SOIC – Tape and Reel	Commercial (0° to 70°C)
CY23S09SXC-1	SZ16	16-pin 150-mil SOIC	Commercial (0° to 70°C)
CY23S09SXC-1T	SZ16	16-pin 150-mil SOIC – Tape and Reel	Commercial (0° to 70°C)
CY23S09SXC-1H	SZ16	16-pin 150-mil SOIC	Commercial (0° to 70°C)
CY23S09SXC-1HT	SZ16	16-pin 150-mil SOIC – Tape and Reel	Commercial (0° to 70°C)
CY23S09ZXC-1H	ZZ16	16-pin 4.4 mm TSSOP	Commercial (0° to 70°C)
CY23S09ZXC-1HT	ZZ16	16-pin 4.4 mm TSSOP – Tape and Reel	Commercial (0° to 70°C)

Notes

9. Not recommended for new designs. New designs should use Pb-free devices.

Package Diagrams

Figure 8. 8-Pin (150-Mil) SOIC S08 and SZ08

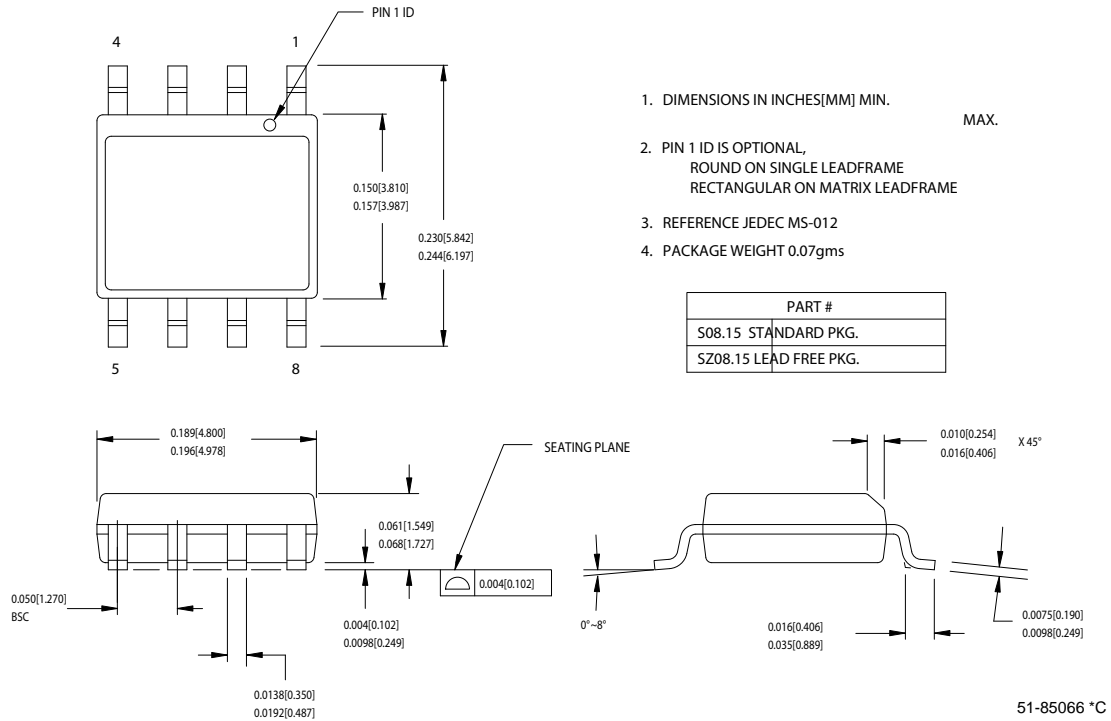
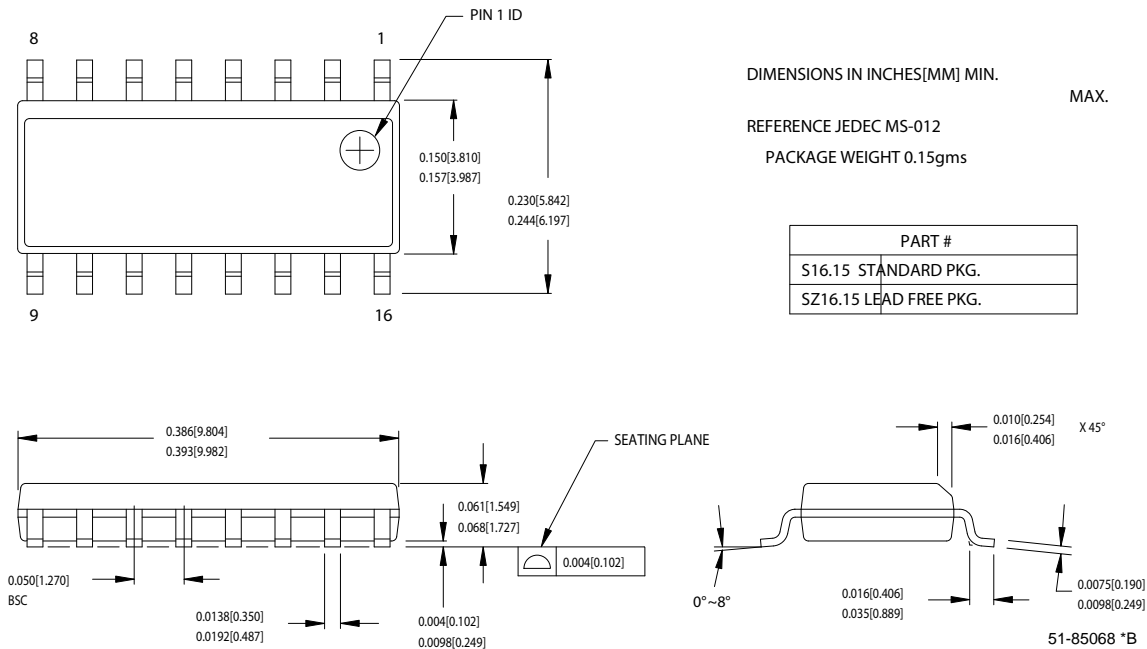
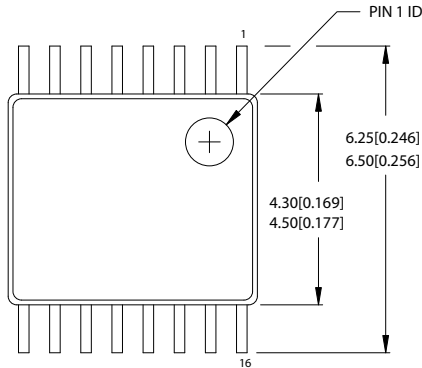

Figure 9. 16-Pin (150-Mil) SOIC S16 and SZ16



Package Diagrams continued

Figure 10. 16-Pin TSSOP 4.40 mm Body Z16 and ZZ16



DIMENSIONS IN MM[INCHES] MIN.
MAX.

REFERENCE JEDEC MO-153

PACKAGE WEIGHT 0.05 gms

PART #	
Z16.173	STANDARD PKG.
ZZ16.173	LEAD FREE PKG.

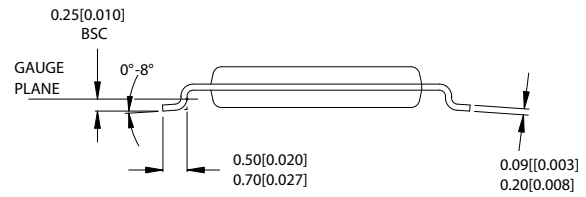
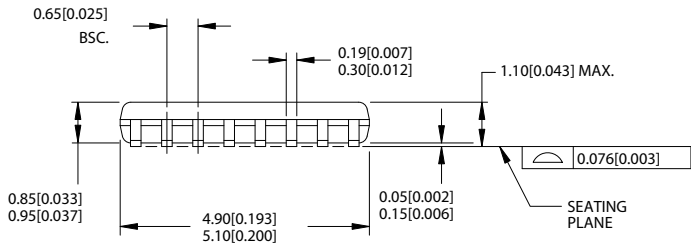

51-85091 *A

Document History Page

Document Title: CY23S09/CY23S05 Low Cost 3.3V Spread Aware Zero Delay Buffer				
Document Number: 38-07296				
Rev.	ECN No.	Submission Date	Orig. of Change	Description of Change
**	111147	11/14/01	DSG	Changed from spec number 38-01094 to 38-07296
*A	111773	02/20/02	CTK	Added 150-mil SSOP option
*B	122885	12/22/02	RBI	Added power-up requirements to Operating Conditions
*C	267849	See ECN	RGL	Added Lead-Free devices
*D	2595524	10/23/08	CXQ/PYRS	Added device "Status" to Ordering Information
*E	2761988	09/10/09	KVM	Removed obsolete parts from Ordering Information table: CY23S09ZC-1, CY23S09OC-1, CY23S09OC-1H, CY23S09ZXC-1, CY23S09OXC-1, CY23S09OXC-1H. Added CY23S05SXC-1T, CY23S05SXC-1HT, CY23S09SXC-1T, CY23S09SXC-1HT, CY23S09ZXC-1HT. Removed Status column from Ordering Information table; added footnote. Updated package names and added numerical temperature range to Ordering Information table. Removed QSOP package drawing.

Sales, Solutions, and Legal Information

Worldwide Sales and Design Support

Cypress maintains a worldwide network of offices, solution centers, manufacturer's representatives, and distributors. To find the office closest to you, visit us at cypress.com/sales.

Products

PSoC	psoc.cypress.com
Clocks & Buffers	clocks.cypress.com
Wireless	wireless.cypress.com
Memories	memory.cypress.com
Image Sensors	image.cypress.com

© Cypress Semiconductor Corporation, 2001-2009. The information contained herein is subject to change without notice. Cypress Semiconductor Corporation assumes no responsibility for the use of any circuitry other than circuitry embodied in a Cypress product. Nor does it convey or imply any license under patent or other rights. Cypress products are not warranted nor intended to be used for medical, life support, life saving, critical control or safety applications, unless pursuant to an express written agreement with Cypress. Furthermore, Cypress does not authorize its products for use as critical components in life-support systems where a malfunction or failure may reasonably be expected to result in significant injury to the user. The inclusion of Cypress products in life-support systems application implies that the manufacturer assumes all risk of such use and in doing so indemnifies Cypress against all charges.

Any Source Code (software and/or firmware) is owned by Cypress Semiconductor Corporation (Cypress) and is protected by and subject to worldwide patent protection (United States and foreign), United States copyright laws and international treaty provisions. Cypress hereby grants to licensee a personal, non-exclusive, non-transferable license to copy, use, modify, create derivative works of, and compile the Cypress Source Code and derivative works for the sole purpose of creating custom software and/or firmware in support of licensee product to be used only in conjunction with a Cypress integrated circuit as specified in the applicable agreement. Any reproduction, modification, translation, compilation, or representation of this Source Code except as specified above is prohibited without the express written permission of Cypress.

Disclaimer: CYPRESS MAKES NO WARRANTY OF ANY KIND, EXPRESS OR IMPLIED, WITH REGARD TO THIS MATERIAL, INCLUDING, BUT NOT LIMITED TO, THE IMPLIED WARRANTIES OF MERCHANTABILITY AND FITNESS FOR A PARTICULAR PURPOSE. Cypress reserves the right to make changes without further notice to the materials described herein. Cypress does not assume any liability arising out of the application or use of any product or circuit described herein. Cypress does not authorize its products for use as critical components in life-support systems where a malfunction or failure may reasonably be expected to result in significant injury to the user. The inclusion of Cypress' product in a life-support systems application implies that the manufacturer assumes all risk of such use and in doing so indemnifies Cypress against all charges.

Use may be limited by and subject to the applicable Cypress software license agreement.