



# 512K x 8 Static RAM

## Features

- **High speed**  
—  $t_{AA} = 15 \text{ ns}$
- **Low active power**  
— **504 mW (max.)**
- **Low CMOS standby power (Commercial L version)**  
— **1.8 mW (max.)**
- **2.0V Data Retention (660  $\mu\text{W}$  at 2.0V retention)**
- **Automatic power-down when deselected**
- **TTL-compatible inputs and outputs**
- **Easy memory expansion with  $\overline{\text{CE}}$  and  $\overline{\text{OE}}$  features**

## Functional Description<sup>[1]</sup>

The CY7C1049BV33 is a high-performance CMOS Static RAM organized as 524,288 words by 8 bits. Easy memory

expansion is provided by an active LOW Chip Enable ( $\overline{\text{CE}}$ ), an active LOW Output Enable ( $\overline{\text{OE}}$ ), and three-state drivers. Writing to the device is accomplished by taking Chip Enable ( $\overline{\text{CE}}$ ) and Write Enable ( $\overline{\text{WE}}$ ) inputs LOW. Data on the eight I/O pins ( $\text{I/O}_0$  through  $\text{I/O}_7$ ) is then written into the location specified on the address pins ( $\text{A}_0$  through  $\text{A}_{18}$ ).

Reading from the device is accomplished by taking Chip Enable ( $\overline{\text{CE}}$ ) and Output Enable ( $\overline{\text{OE}}$ ) LOW while forcing Write Enable ( $\overline{\text{WE}}$ ) HIGH. Under these conditions, the contents of the memory location specified by the address pins will appear on the I/O pins.

The eight input/output pins ( $\text{I/O}_0$  through  $\text{I/O}_7$ ) are placed in a high-impedance state when the device is deselected ( $\overline{\text{CE}}$  HIGH), the outputs are disabled ( $\overline{\text{OE}}$  HIGH), or during a write operation ( $\overline{\text{CE}}$  LOW, and  $\overline{\text{WE}}$  LOW).

The CY7C1049BV33 is available in a standard 400-mil-wide 36-pin SOJ and 44-pin TSOPII packages with center power and ground (revolutionary) pinout.

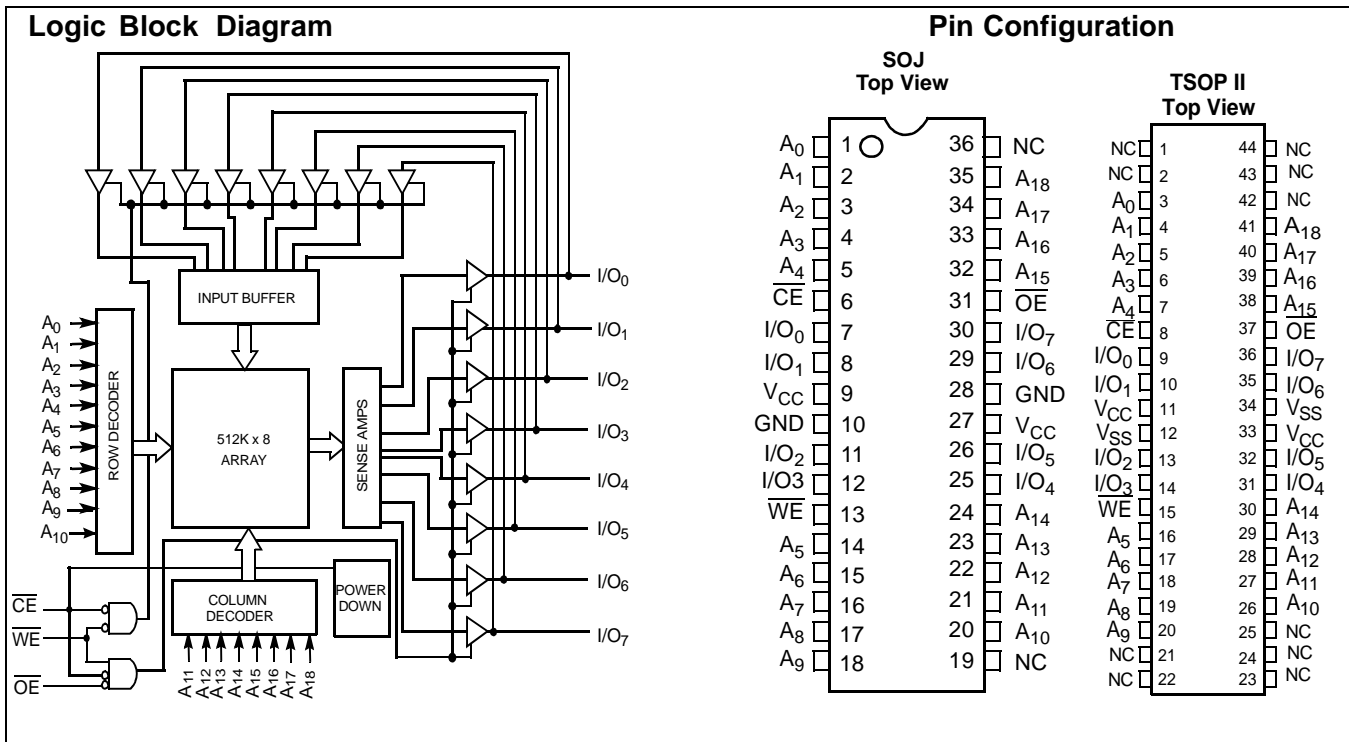

## Selection Guide

		-12	-15	-17	-20	-25
Maximum Access Time (ns)		12	15	17	20	25
Maximum Operating Current (mA)	Comm'l	200	180	170	160	150
	Ind'l	220	200	180	170	170
Maximum CMOS Standby Current (mA)	Com'l/Ind'l	8	8	8	8	8
	Com'l L	0.5	0.5	0.5	0.5	0.5

**Note:**

1. For guidelines on SRAM system design, please refer to the 'System Design Guidelines' Cypress application note, available on the internet at [www.cypress.com](http://www.cypress.com).

**Maximum Ratings**

(Above which the useful life may be impaired. For user guidelines, not tested.)

Storage Temperature ..... -65°C to +150°C

Ambient Temperature with Power Applied..... -55°C to +125°C

Supply Voltage on  $V_{CC}$  to Relative GND<sup>[2]</sup>..... -0.5V to +4.6V

DC Voltage Applied to Outputs<sup>[2]</sup> in High Z State ..... -0.5V to  $V_{CC} + 0.5V$

DC Input Voltage<sup>[2]</sup> ..... -0.5V to  $V_{CC} + 0.5V$

Current into Outputs (LOW) ..... 20 mA

**Operating Range**

Range	Ambient Temperature	$V_{CC}$
Commercial	0°C to +70°C	3.3V ± 0.3V
Industrial	-40°C to +85°C	

**DC Electrical Characteristics Over the Operating Range**

Parameter	Description	Test Conditions	-12		-15		-17		Unit
			Min.	Max.	Min.	Max.	Min.	Max.	
$V_{OH}$	Output HIGH Voltage	$V_{CC} = \text{Min.}, I_{OH} = -4.0 \text{ mA}$	2.4		2.4		2.4		V
$V_{OL}$	Output LOW Voltage	$V_{CC} = \text{Min.}, I_{OL} = 8.0 \text{ mA}$		0.4		0.4		0.4	V
$V_{IH}$	Input HIGH Voltage		2.2	$V_{CC} + 0.5$	2.2	$V_{CC} + 0.5$	2.2	$V_{CC} + 0.5$	V
$V_{IL}$	Input LOW Voltage <sup>[2]</sup>		-0.5	0.8	-0.5	0.8	-0.5	0.8	V
$I_{IX}$	Input Load Current	$GND \leq V_I \leq V_{CC}$	-1	+1	-1	+1	-1	+1	μA
$I_{OZ}$	Output Leakage Current	$GND \leq V_{OUT} \leq V_{CC}$ , Output Disabled	-1	+1	-1	+1	-1	+1	μA
$I_{CC}$	$V_{CC}$ Operating Supply Current	$V_{CC} = \text{Max.}, f = f_{MAX} = 1/t_{RC}$	Com'l	200		180		170	mA
			Ind'l	220		200		180	mA
$I_{SB1}$	Automatic CE Power-Down Current —TTL Inputs	Max. $V_{CC}$ , $\overline{CE} \geq V_{IH}$ $V_{IN} \geq V_{IH}$ or $V_{IN} \leq V_{IL}$ , $f = f_{MAX}$		30		30		30	mA
$I_{SB2}$	Automatic CE Power-Down Current —CMOS Inputs	Max. $V_{CC}$ , $\overline{CE} \geq V_{CC} - 0.3V$ , $V_{IN} \geq V_{CC} - 0.3V$ , or $V_{IN} \leq 0.3V$ , $f = 0$	Com'l/Ind'l	8		8		8	mA
			Com'l L	0.5		0.5		0.5	mA

**Note:**

2.  $V_{IL}$  (min.) = -2.0V for pulse durations of less than 20 ns.

**DC Electrical Characteristics** Over the Operating Range (continued)

Parameter	Description	Test Conditions	-20		-25		Unit	
			Min.	Max.	Min.	Max.		
$V_{OH}$	Output HIGH Voltage	$V_{CC} = \text{Min.}, I_{OH} = -4.0 \text{ mA}$	2.4		2.4		V	
$V_{OL}$	Output LOW Voltage	$V_{CC} = \text{Min.}, I_{OL} = 8.0 \text{ mA}$		0.4		0.4	V	
$V_{IH}$	Input HIGH Voltage		2.2	$V_{CC} + 0.5$	2.2	$V_{CC} + 0.5$	V	
$V_{IL}$	Input LOW Voltage <sup>[2]</sup>		-0.5	0.8	-0.5	0.8	V	
$I_{IX}$	Input Load Current	$GND \leq V_I \leq V_{CC}$	-1	+1	-1	+1	$\mu\text{A}$	
$I_{OZ}$	Output Leakage Current	$GND \leq V_{OUT} \leq V_{CC},$ Output Disabled	-1	+1	-1	+1	$\mu\text{A}$	
$I_{CC}$	$V_{CC}$ Operating Supply Current	$V_{CC} = \text{Max.},$ $f = f_{MAX} = 1/t_{RC}$	Com'l			160	150	mA
			Ind'l			170	170	mA
$I_{SB1}$	Automatic CE Power-Down Current —TTL Inputs	Max. $V_{CC}, \overline{CE} \geq V_{IH}$ $V_{IN} \geq V_{IH}$ or $V_{IN} \leq V_{IL}, f = f_{MAX}$		30		30	mA	
$I_{SB2}$	Automatic CE Power-Down Current —CMOS Inputs	Max. $V_{CC},$ $\overline{CE} \geq V_{CC} - 0.3\text{V},$ $V_{IN} \geq V_{CC} - 0.3\text{V},$ or $V_{IN} \leq 0.3\text{V}, f = 0$	Com'l/Ind'l			8	8	mA
			Com'l	L		0.5	0.5	mA

**Capacitance<sup>[3]</sup>**

Parameter	Description	Test Conditions	Max.	Unit
$C_{IN}$	Input Capacitance	$T_A = 25^\circ\text{C}, f = 1 \text{ MHz},$ $V_{CC} = 3.3\text{V}$	8	pF
$C_{OUT}$	I/O Capacitance		8	pF

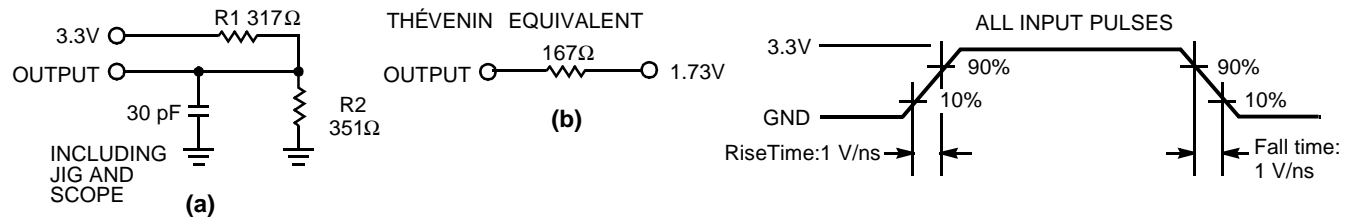
**AC Test Loads and Waveforms**

**Note:**

- Tested initially and after any design or process changes that may affect these parameters.

**AC Switching Characteristics<sup>[4]</sup> Over the Operating Range**

Parameter	Description	-12		-15		-17		Unit
		Min.	Max.	Min.	Max.	Min.	Max.	
<b>Read Cycle</b>								
$t_{power}$	$V_{CC}$ (typical) to the First Access <sup>[5]</sup>	1		1		1		$\mu$ s
$t_{RC}$	Read Cycle Time	12		15		17		ns
$t_{AA}$	Address to Data Valid		12		15		17	ns
$t_{OHA}$	Data Hold from Address Change	3		3		3		ns
$t_{ACE}$	$\overline{CE}$ LOW to Data Valid		12		15		17	ns
$t_{DOE}$	$\overline{OE}$ LOW to Data Valid		6		7		8	ns
$t_{LZOE}$	$\overline{OE}$ LOW to Low Z	0		0		0		ns
$t_{HZOE}$	$\overline{OE}$ HIGH to High Z <sup>[6, 7]</sup>		6		7		8	ns
$t_{LZCE}$	$\overline{CE}$ LOW to Low Z <sup>[7]</sup>	3		3		3		ns
$t_{HZCE}$	$\overline{CE}$ HIGH to High Z <sup>[6, 7]</sup>		6		7		8	ns
$t_{PU}$	$\overline{CE}$ LOW to Power-Up	0		0		0		ns
$t_{PD}$	$\overline{CE}$ HIGH to Power-Down		12		15		17	ns
<b>Write Cycle<sup>[8, 9]</sup></b>								
$t_{WC}$	Write Cycle Time	12		15		17		ns
$t_{SCE}$	$\overline{CE}$ LOW to Write End	10		12		13		ns
$t_{AW}$	Address Set-Up to Write End	10		12		13		ns
$t_{HA}$	Address Hold from Write End	0		0		0		ns
$t_{SA}$	Address Set-Up to Write Start	0		0		0		ns
$t_{PWE}$	$\overline{WE}$ Pulse Width	10		12		13		ns
$t_{SD}$	Data Set-Up to Write End	7		8		9		ns
$t_{HD}$	Data Hold from Write End	0		0		0		ns
$t_{LZWE}$	$\overline{WE}$ HIGH to Low Z <sup>[7]</sup>	3		3		3		ns
$t_{HZWE}$	$\overline{WE}$ LOW to High Z <sup>[6, 7]</sup>		6		7		8	ns

**Notes:**

- Test conditions assume signal transition time of 3 ns or less, timing reference levels of 1.5V, input pulse levels of 0 to 3.0V, and output loading of the specified  $I_{OL}/I_{OH}$  and 30-pF load capacitance.
- This part has a voltage regulator which steps down the voltage from 5V to 3.3V internally.  $T_{power}$  time has to be provided initially before a read/write operation is started.
- $t_{HZOE}$ ,  $t_{HZCE}$ , and  $t_{HZWE}$  are specified with a load capacitance of 5 pF as in part (b) of AC Test Loads. Transition is measured  $\pm 500$  mV from steady-state voltage.
- At any given temperature and voltage condition,  $t_{HZCE}$  is less than  $t_{LZCE}$ ,  $t_{HZOE}$  is less than  $t_{LZOE}$ , and  $t_{HZWE}$  is less than  $t_{LZWE}$  for any given device.
- The internal write time of the memory is defined by the overlap of  $\overline{CE}$  LOW, and  $\overline{WE}$  LOW.  $\overline{CE}$  and  $\overline{WE}$  must be LOW to initiate a write, and the transition of either of these signals can terminate the write. The input data set-up and hold timing should be referenced to the leading edge of the signal that terminates the write.
- The minimum write cycle time for Write Cycle No. 3 ( $\overline{WE}$  controlled,  $\overline{OE}$  LOW) is the sum of  $t_{HZWE}$  and  $t_{SD}$ .

**AC Switching Characteristics<sup>[4]</sup> Over the Operating Range (continued)**

Parameter	Description	-20		-25		Unit
		Min.	Max.	Min.	Max.	
<b>Read Cycle</b>						
$t_{power}$	$V_{CC}$ (typical) to the First Access <sup>[6]</sup>	1		1		$\mu$ s
$t_{RC}$	Read Cycle Time	20		25		ns
$t_{AA}$	Address to Data Valid		20		25	ns
$t_{OHA}$	Data Hold from Address Change	3		3		ns
$t_{ACE}$	$\overline{CE}$ LOW to Data Valid		20		25	ns
$t_{DOE}$	$\overline{OE}$ LOW to Data Valid		8		10	ns
$t_{LZOE}$	$\overline{OE}$ LOW to Low Z	0		0		ns
$t_{HZOE}$	$\overline{OE}$ HIGH to High Z <sup>[6, 7]</sup>		8		10	ns
$t_{LZCE}$	$\overline{CE}$ LOW to Low Z <sup>[7]</sup>	3		3		ns
$t_{HZCE}$	$\overline{CE}$ HIGH to High Z <sup>[6, 7]</sup>		8		10	ns
$t_{PU}$	$\overline{CE}$ LOW to Power-Up	0		0		ns
$t_{PD}$	$\overline{CE}$ HIGH to Power-Down		20		25	ns
<b>Write Cycle<sup>[9]</sup></b>						
$t_{WC}$	Write Cycle Time	20		25		ns
$t_{SCE}$	$\overline{CE}$ LOW to Write End	13		15		ns
$t_{AW}$	Address Set-Up to Write End	13		15		ns
$t_{HA}$	Address Hold from Write End	0		0		ns
$t_{SA}$	Address Set-Up to Write Start	0		0		ns
$t_{PWE}$	$\overline{WE}$ Pulse Width	13		15		ns
$t_{SD}$	Data Set-Up to Write End	9		10		ns
$t_{HD}$	Data Hold from Write End	0		0		ns
$t_{LZWE}$	$\overline{WE}$ HIGH to Low Z <sup>[7]</sup>	3		3		ns
$t_{HZWE}$	$\overline{WE}$ LOW to High Z <sup>[6, 7]</sup>		8		10	ns

**Data Retention Characteristics Over the Operating Range (For L version only)**

Parameter	Description	Conditions <sup>[10]</sup>	Min.	Max	Unit
$V_{DR}$	$V_{CC}$ for Data Retention		2.0		V
$I_{CCDR}$	Data Retention Current	$V_{CC} = V_{DR} = 2.0V$ , $CE \geq V_{CC} - 0.3V$ $V_{IN} \geq V_{CC} - 0.3V$ or $V_{IN} \leq 0.3V$		330	$\mu$ A
$t_{CDR}^{[3]}$	Chip Deselect to Data Retention Time		0		ns
$t_R^{[11]}$	Operation Recovery Time		$t_{RC}$		ns

**Notes:**

10. No input may exceed  $V_{CC} + 0.5V$

11.  $t_r \leq 3$  ns for the -12 and -15 speeds.  $t_r \leq 5$  ns for the -20 ns and slower speeds.

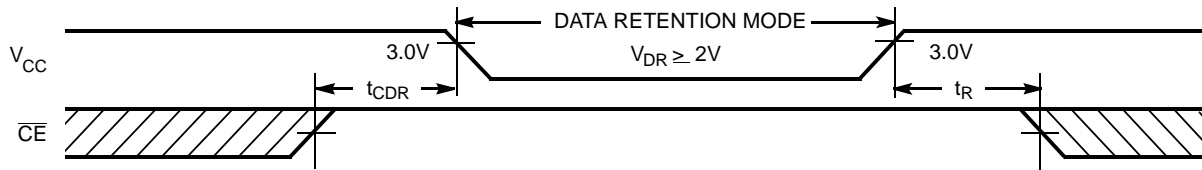
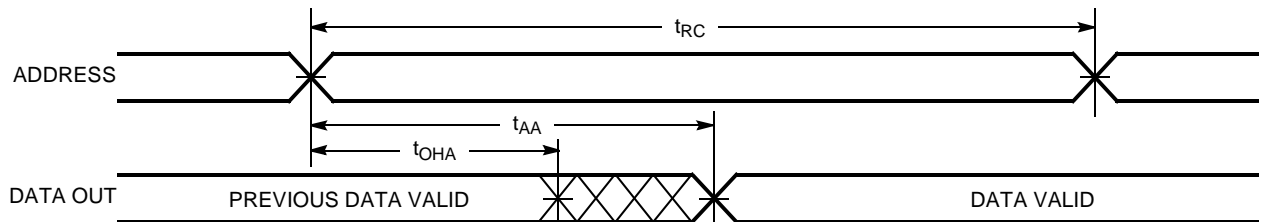
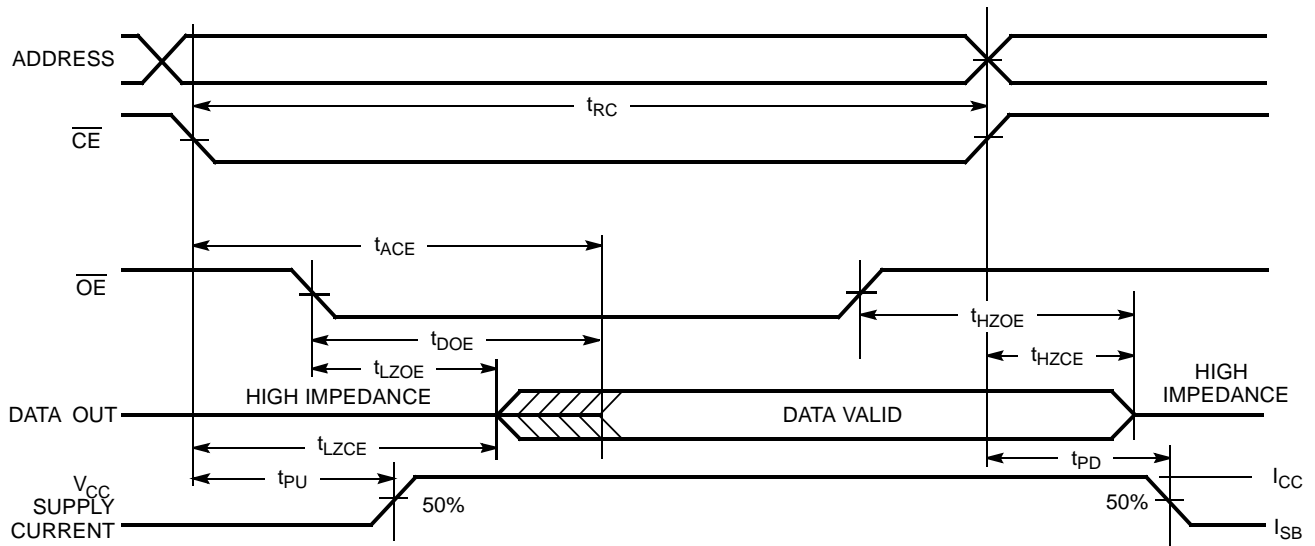
**Data Retention Waveform**

**Switching Waveforms**
**Read Cycle No. 1<sup>[12, 13]</sup>**

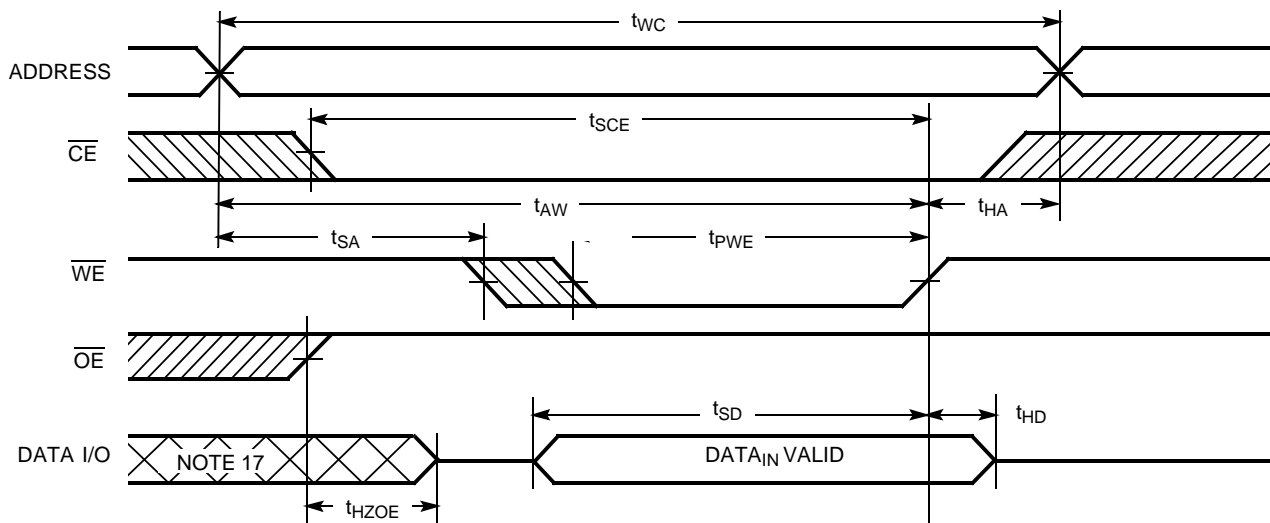
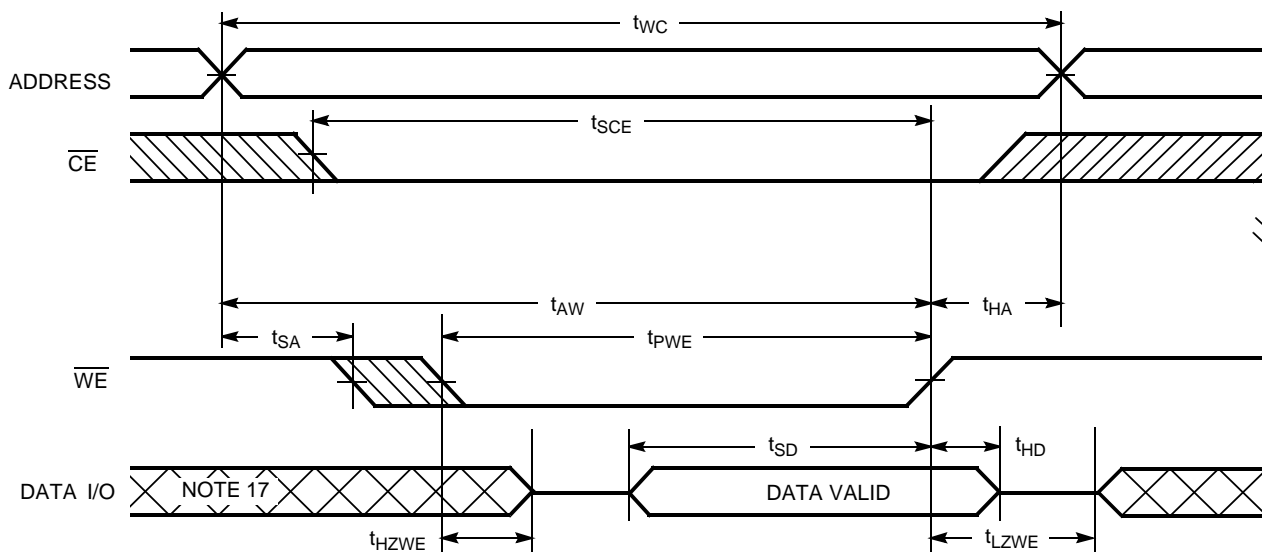
**Read Cycle No. 2 ( $\overline{OE}$  Controlled)<sup>[13, 14]</sup>**

**Notes:**

12. Device is continuously selected.  $\overline{OE}, \overline{CE} = V_{IL}$ .
13.  $\overline{WE}$  is HIGH for read cycle.
14. Address valid prior to or coincident with  $\overline{CE}$  transition LOW.

**Switching Waveforms (continued)**
**Write Cycle No. 1 ( $\overline{WE}$  Controlled,  $\overline{OE}$  HIGH During Write)<sup>[15, 16]</sup>**

**Write Cycle No. 2 ( $\overline{WE}$  Controlled,  $\overline{OE}$  LOW)<sup>[16]</sup>**

**Truth Table**

CE	OE	WE	I/O <sub>0</sub> - I/O <sub>7</sub>	Mode	Power
H	X	X	High Z	Power-Down	Standby ( $I_{SB}$ )
L	L	H	Data Out	Read	Active ( $I_{CC}$ )
L	X	L	Data In	Write	Active ( $I_{CC}$ )
L	H	H	High Z	Selected, Outputs Disabled	Active ( $I_{CC}$ )

**Notes:**

15. Data I/O is high-impedance if  $\overline{OE} = V_{IH}$ .

16. If CE goes HIGH simultaneously with WE going HIGH, the output remains in a high-impedance state.

17. During this period the I/Os are in the output state and input signals should not be applied.

**Ordering Information**

Speed (ns)	Ordering Code	Package Name	Package Type	Operating Range
12	CY7C1049BV33-12VC	V36	36-Lead (400-Mil) Molded SOJ	Commercial
	CY7C1049BV33-12ZC	Z44	44-Pin TSOP II Z44	
	CY7C1049BV33L-12VC	V36	36-Lead (400-Mil) Molded SOJ	
	CY7C1049BV33-12VI	V36	36-Lead (400-Mil) Molded SOJ	
15	CY7C1049BV33-15VC	V36	36-Lead (400-Mil) Molded SOJ	Commercial
	CY7C1049BV33L-15VC	V36	36-Lead (400-Mil) Molded SOJ	
	CY7C1049BV33-15ZC	Z44	44-Pin TSOP II Z44	
	CY7C1049BV33L-15ZC	Z44	44-Pin TSOP II Z44	
	CY7C1049BV33-15VI	V36	36-Lead (400-Mil) Molded SOJ	Industrial
	CY7C1049BV33-15ZI	Z44	44-Pin TSOP II Z44	
17	CY7C1049BV33-17VC	V36	36-Lead (400-Mil) Molded SOJ	Commercial
	CY7C1049BV33L-17VC	V36	36-Lead (400-Mil) Molded SOJ	
	CY7C1049BV33-17ZC	Z44	44-Pin TSOP II Z44	
	CY7C1049BV33L-17ZC	Z44	44-Pin TSOP II Z44	
	CY7C1049BV33-17VI	V36	36-Lead (400-Mil) Molded SOJ	Industrial
	CY7C1049BV33L-17VI	V36	36-Lead (400-Mil) Molded SOJ	
	CY7C1049BV33-17ZI	Z44	44-Pin TSOP II Z44	
20	CY7C1049BV33-20VC	V36	36-Lead (400-Mil) Molded SOJ	Commercial
	CY7C1049BV33L-20VC	V36	36-Lead (400-Mil) Molded SOJ	
	CY7C1049BV33-20ZC	Z44	44-Pin TSOP II Z44	
	CY7C1049BV33L-20ZC	Z44	44-Pin TSOP II Z44	
	CY7C1049BV33-20VI	V36	36-Lead (400-Mil) Molded SOJ	Industrial
	CY7C1049BV33-20ZI	Z44	44-Pin TSOP II Z44	
25	CY7C1049BV33-25VC	V36	36-Lead (400-Mil) Molded SOJ	Commercial
	CY7C1049BV33L-25VC	V36	36-Lead (400-Mil) Molded SOJ	
	CY7C1049BV33-25ZC	Z44	44-Pin TSOP II Z44	
	CY7C1049BV33L-25ZC	Z44	44-Pin TSOP II Z44	
	CY7C1049BV33-25VI	v36	36-Lead (400-Mil) Molded SOJ	Industrial

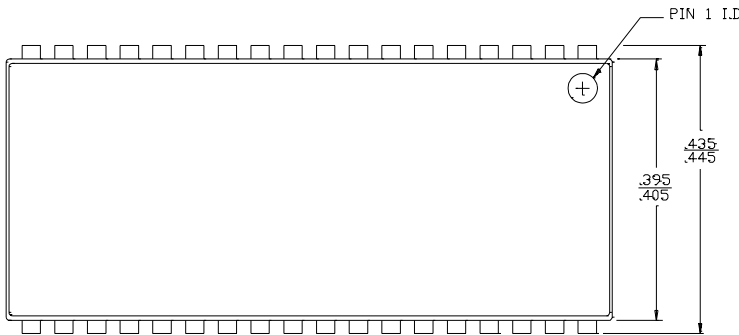

**Package Diagrams**
**36-Lead (400-Mil) Molded SOJ V36**

 DIMENSIONS IN INCHES MIN.  
MAX.

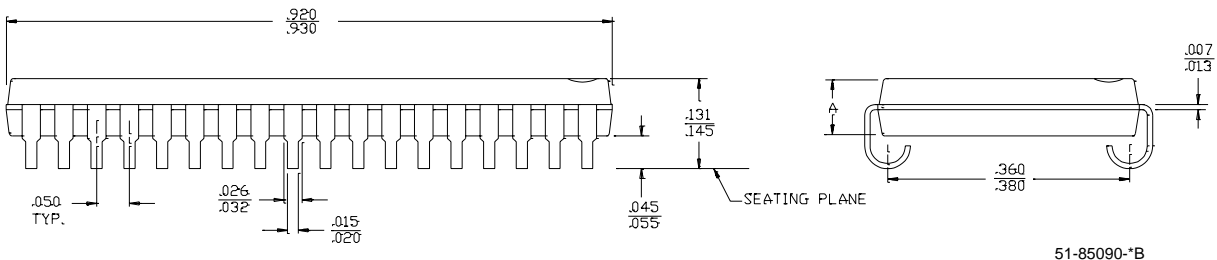
DIM. A	
ANAM	CSPI
.086	.095
.090	.115

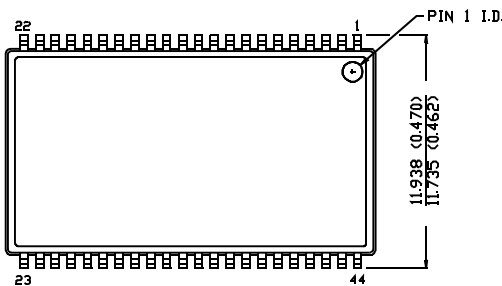

51-85090-\*B

**44-Pin TSOP II Z44**

 DIMENSION IN MM (INCH)  
MAX  
MIN.

TOP VIEW

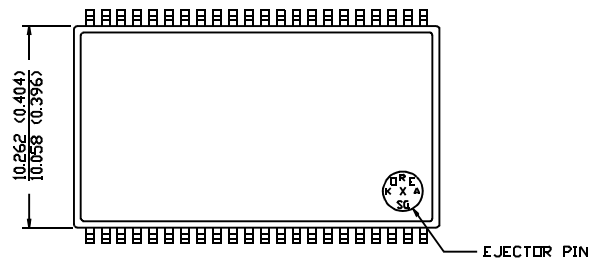

BOTTOM VIEW

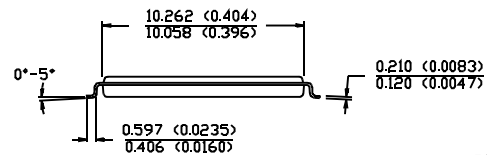
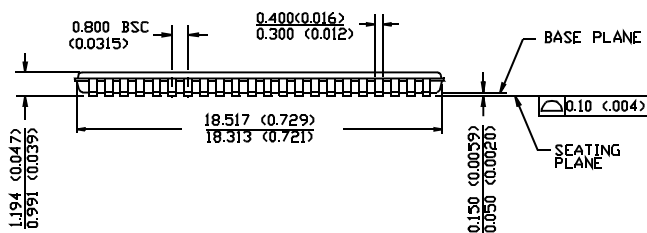

51-85087-\*A

All product and company names mentioned in this document may be the trademarks of their respective holders.

**Document History Page**

<b>Document Title: CY7C1049BV33 512K x 8 Static RAM</b> <b>Document Number: 38-05139</b>				
<b>REV.</b>	<b>ECN NO.</b>	<b>Issue Date</b>	<b>Orig. of Change</b>	<b>Description of Change</b>
**	113091	02/13/02	DSG	Change from Spec number: 38-00931 to 38-05139
*A	116475	09/16/02	CEA	Add applications foot note to data sheet, page 1