

J Series® 2016 Gen 2 3-V P Class LEDs



PRODUCT DESCRIPTION

J Series® LEDs extend Cree’s industry leading portfolio of lighting class LEDs to a broader set of applications. The J Series 2016 LED combines high quality and excellent value in a thin, compact package. The J Series 2016 LED is optimized for compact lighting applications where smooth appearance is critical, such as linear lamps, downlights, troffers and panel lights.

FEATURES

- Industry-compatible size : 2.0 x 1.6 x 0.5 mm
- 3-V configuration
- Flux and chromaticity binned at 25 °C
- 6500 K–2200 K ANSI CCTs available
- 80, 90 & 95 CRI available
- RoHS and REACH compliant
- UL® recognized component (E495478)

PRODUCT SUMMARY

Product	Power Class	Test Temperature	Test Current	Typical Forward Voltage	4000 K, 80 CRI		3000 K, 90 CRI		Maximum Current
					Typical Flux	Typical Efficacy	Typical Flux	Typical Efficacy	
JB2016 Gen 2 3-V P Class	0.2 W	25 °C	60 mA	3 V	27.8 lm	154 LPW	23 lm	128 LPW	120 mA



J Series® Products are sold exclusively by Cree Venture LED Company Limited (“Cree Venture”), regardless of geography. Any orders for J Series Products that are submitted to Cree LED or any of its other subsidiaries will be directed to Cree Venture for acknowledgment and order fulfillment.

Cree LED / 4400 Silicon Drive / Durham, NC 27703 USA / +1.919.313.5330 / www.cree-led.com

TABLE OF CONTENTS

Order Code & Bin Code Formats 3

Characteristics 4

Operating Limits..... 4

Flux Characteristics, Order Codes and Bins 5

Relative Luminous Flux vs. Current..... 6

Electrical Characteristics..... 6

Relative Chromaticity vs. Current..... 7

Relative Chromaticity vs. Temperature..... 7

Relative Spectral Power Distribution 8

Relative Luminous Flux vs. Junction Temperature 9

Typical Spatial Distribution..... 9

Performance Groups - Luminous Flux 10

Performance Groups - Forward Voltage..... 10

Performance Groups - Chromaticity 11

Reflow Soldering Characteristics..... 20

Notes 21

Mechanical Dimensions 23

Tape & Reel..... 24

Packaging..... 25

ORDER CODE & BIN CODE FORMATS

Order codes and bin codes for J Series 2016 Gen 2 3-V P Class LEDs are configured in the following manner:

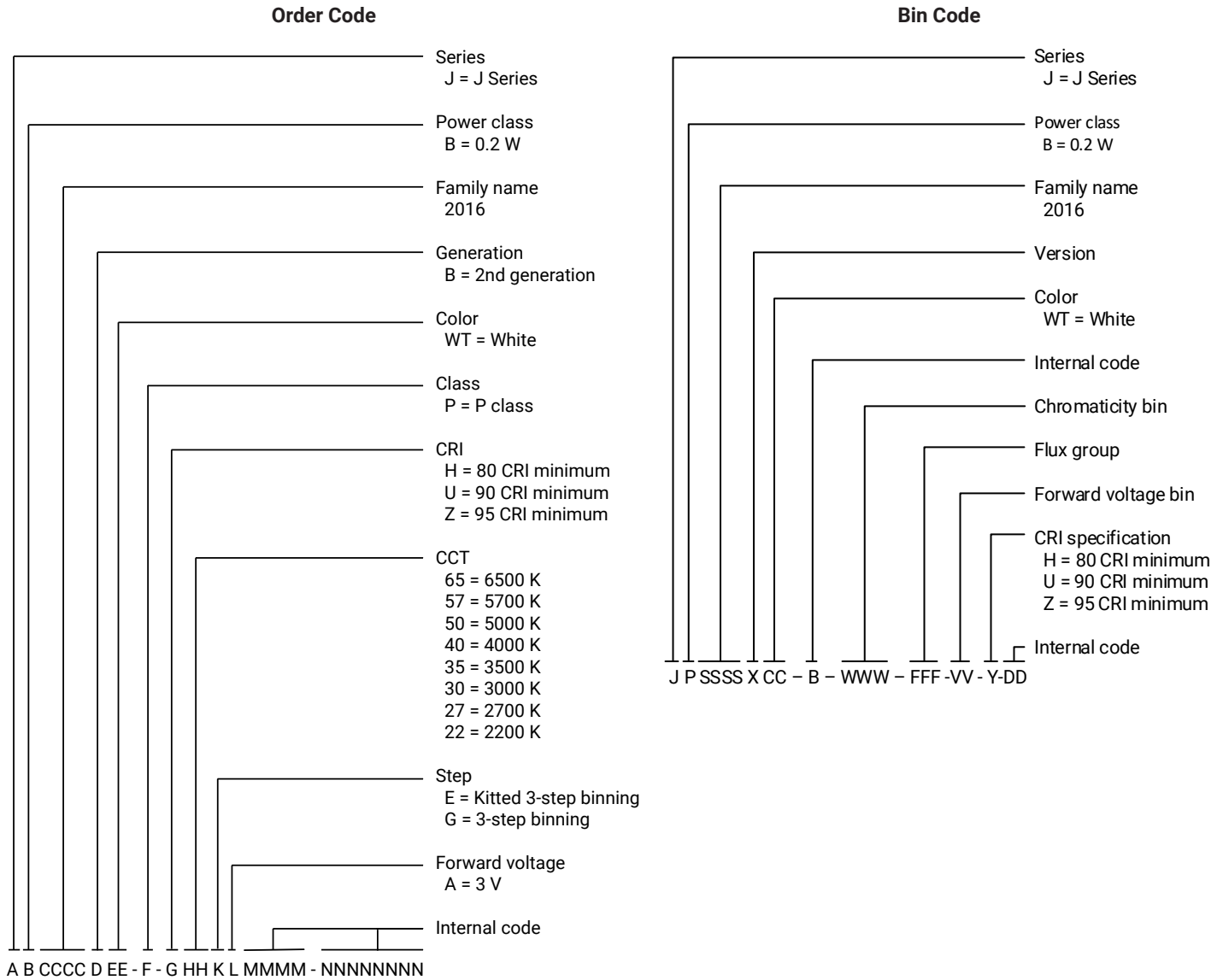

CHARACTERISTICS

Characteristics	Unit	Minimum	Typical	Maximum
Thermal resistance, junction to solder point	°C/W		34	
Viewing angle (FWHM)	degrees		120	
Temperature coefficient of voltage	mV/°C		-1.1	
ESD withstand voltage (JEDEC JS-001-2012)			Class 2	
DC forward current	mA			120
Reverse voltage	V			5
Forward voltage (@ 60 mA, 25 °C)	V		3.0	3.2
LED junction temperature	°C			120
Operating temperature	°C	-40		105

OPERATING LIMITS

The maximum forward current is determined by the thermal resistance between the LED junction and ambient.

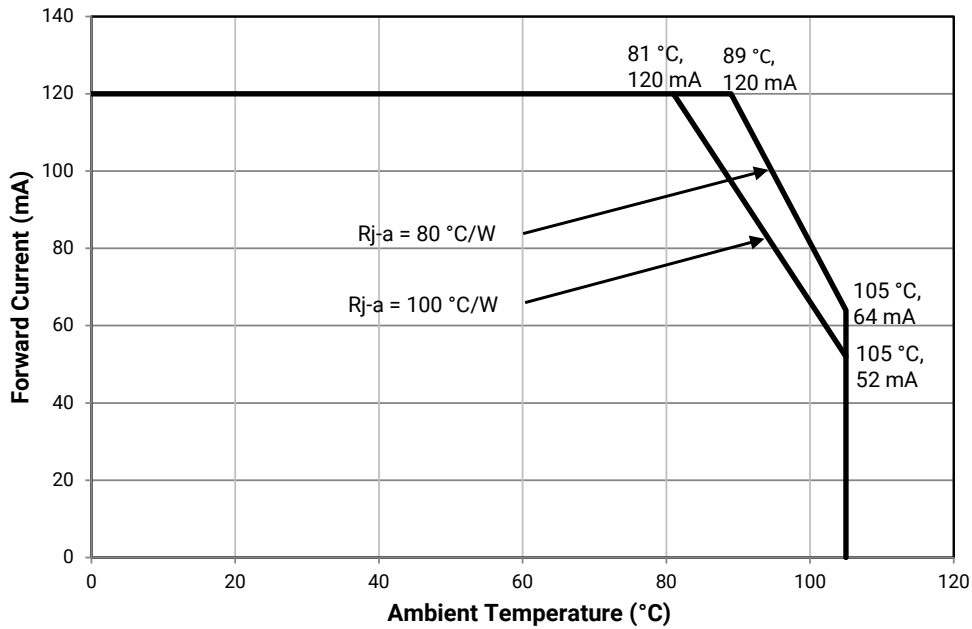

FLUX CHARACTERISTICS, ORDER CODES AND BINS ($I_F = 60 \text{ mA}$, $T_j = 25 \text{ }^\circ\text{C}$)

The following table provides order codes for J Series 2016 Gen 2 3-V P Class LEDs. For a complete description of the order code nomenclature, please see the Order Code and Bin Code Formats section (page 3). For definitions of the chromaticity kits, please see the Performance Groups - Chromaticity section (page 11).

Nominal CCT	Minimum CRI	Minimum Flux (lm) @ 25 °C	Typical Flux (lm) @ 25 °C	Typical Flux (lm) @ 85 °C*	Order Code	
					3-Step	Kitted 3-Step**
6500 K	80	24	27.8	24.9	JB2016BWT-P-H65GA0000-N0000001	JB2016BWT-P-H65EA0000-N0000001
	90	22	24	21.5	JB2016BWT-P-U65GA0000-N0000001	JB2016BWT-P-U65EA0000-N0000001
	95	18	21	18.8	JB2016BWT-P-Z65GA0000-N0000001	JB2016BWT-P-Z65EA0000-N0000001
5700 K	80	26	27.8	24.9	JB2016BWT-P-H57GA0000-N0000001	JB2016BWT-P-H57EA0000-N0000001
	90	22	24	21.5	JB2016BWT-P-U57GA0000-N0000001	JB2016BWT-P-U57EA0000-N0000001
5000 K	80	26	27.8	24.9	JB2016BWT-P-H50GA0000-N0000001	JB2016BWT-P-H50EA0000-N0000001
	90	22	24	21.5	JB2016BWT-P-U50GA0000-N0000001	JB2016BWT-P-U50EA0000-N0000001
	95	18	21	18.8	JB2016BWT-P-Z50GA0000-N0000001	JB2016BWT-P-Z50EA0000-N0000001
4000 K	80	26	27.8	24.9	JB2016BWT-P-H40GA0000-N0000001	JB2016BWT-P-H40EA0000-N0000001
	90	22	24	21.5	JB2016BWT-P-U40GA0000-N0000001	JB2016BWT-P-U40EA0000-N0000001
	95	18	21	18.8	JB2016BWT-P-Z40GA0000-N0000001	JB2016BWT-P-Z40EA0000-N0000001
3500 K	80	26	27	24.2	JB2016BWT-P-H35GA0000-N0000001	JB2016BWT-P-H35EA0000-N0000001
	90	22	23.5	21.1	JB2016BWT-P-U35GA0000-N0000001	JB2016BWT-P-U35EA0000-N0000001
	95	18	20.5	18.4	JB2016BWT-P-Z35GA0000-N0000001	JB2016BWT-P-Z35EA0000-N0000001
3000 K	80	24	26.5	23.8	JB2016BWT-P-H30GA0000-N0000001	JB2016BWT-P-H30EA0000-N0000001
	90	20	23	20.6	JB2016BWT-P-U30GA0000-N0000001	JB2016BWT-P-U30EA0000-N0000001
	95	18	20	17.9	JB2016BWT-P-Z30GA0000-N0000001	JB2016BWT-P-Z30EA0000-N0000001
2700 K	80	24	25.5	22.9	JB2016BWT-P-H27GA0000-N0000001	JB2016BWT-P-H27EA0000-N0000001
	90	20	21.5	19.3	JB2016BWT-P-U27GA0000-N0000001	JB2016BWT-P-U27EA0000-N0000001
	95	16	19	17	JB2016BWT-P-Z27GA0000-N0000001	JB2016BWT-P-Z27EA0000-N0000001
2200 K	80	22	23.5	21.1	JB2016BWT-P-H22GA0000-N0000001	JB2016BWT-P-H22EA0000-N0000001
	90	18	20.5	18.4	JB2016BWT-P-U22GA0000-N0000001	JB2016BWT-P-U22EA0000-N0000001

Notes:

- Cree Venture maintains a tolerance of $\pm 7\%$ on flux and power measurements, ± 0.005 on chromaticity (CCx, CCy) measurements and ± 2 on CRI measurements. See the Measurements section (page 21).
- Cree Venture J Series 2016 LED order codes specify only a minimum flux bin and not a maximum. Cree Venture may ship reels in flux bins higher than the minimum specified by the order code without advance notice. Shipments will always adhere to the chromaticity restrictions specified by the order code.
- * Flux values @ 85 °C are calculated and for reference only.
- ** Contact your Cree sales representative for kitted 3-step order code details.

RELATIVE LUMINOUS FLUX VS. CURRENT

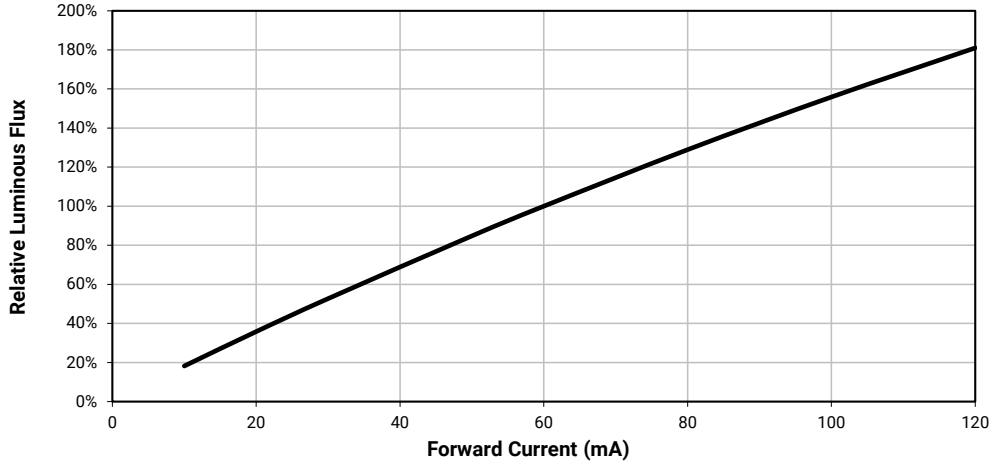

ELECTRICAL CHARACTERISTICS

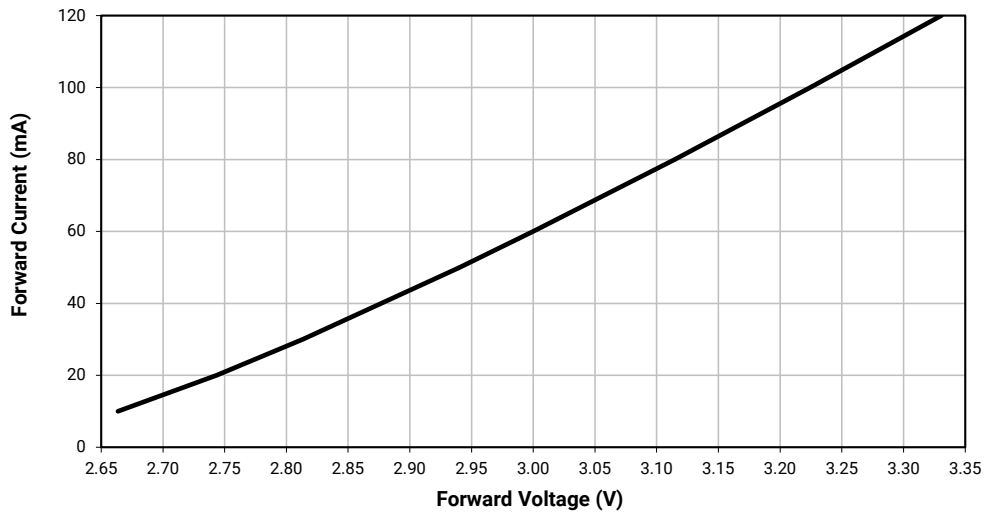

RELATIVE CHROMATICITY VS. CURRENT

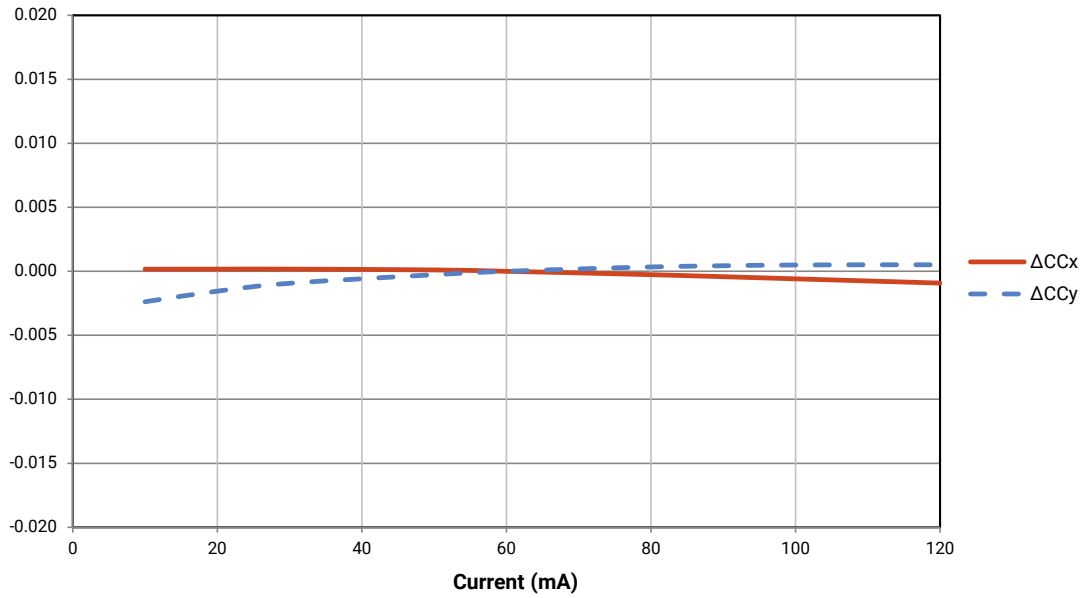

RELATIVE CHROMATICITY VS. TEMPERATURE

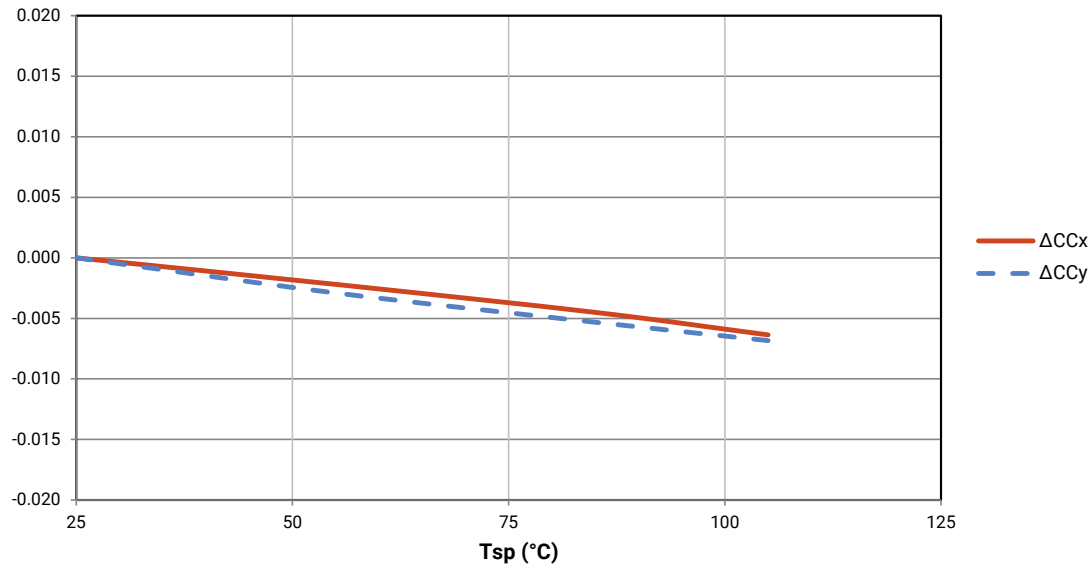

RELATIVE SPECTRAL POWER DISTRIBUTION

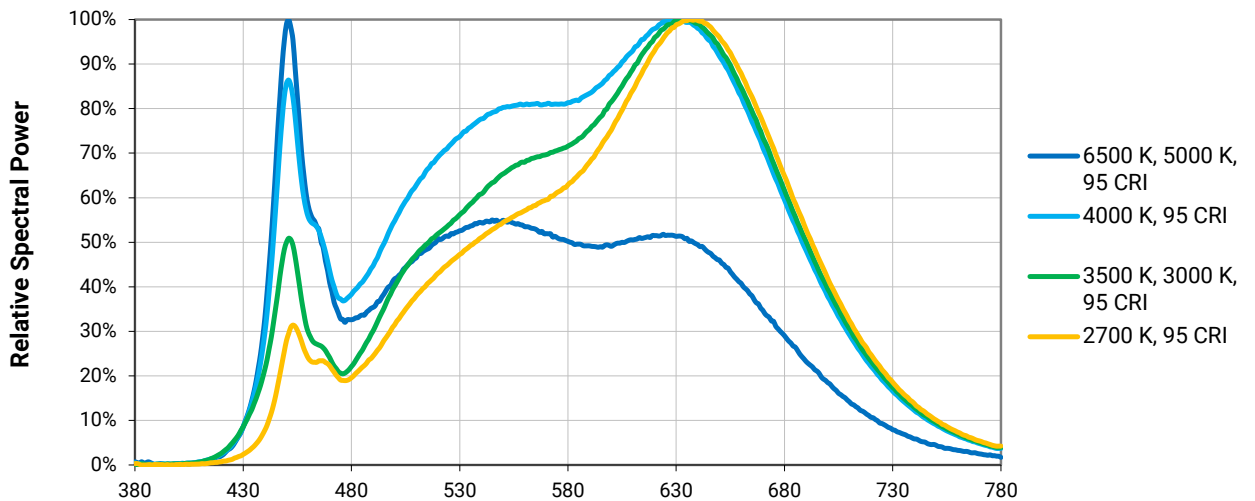
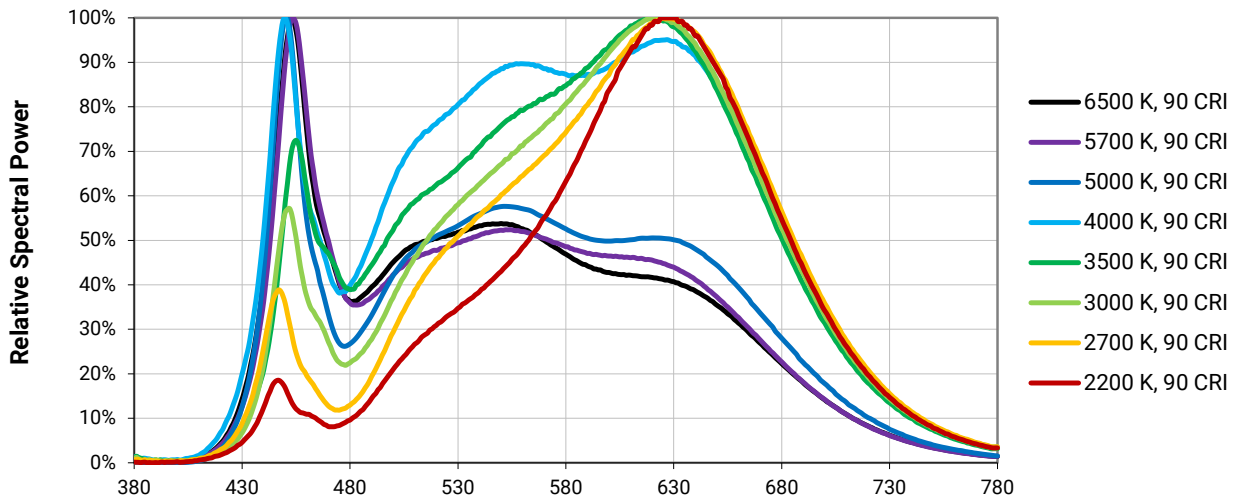
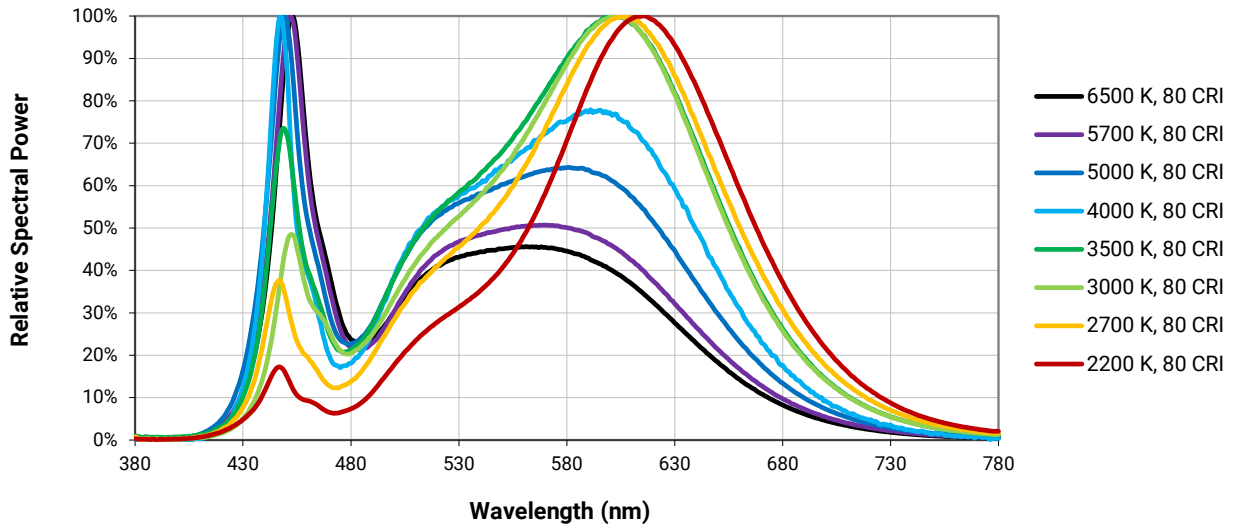

RELATIVE LUMINOUS FLUX VS. JUNCTION TEMPERATURE

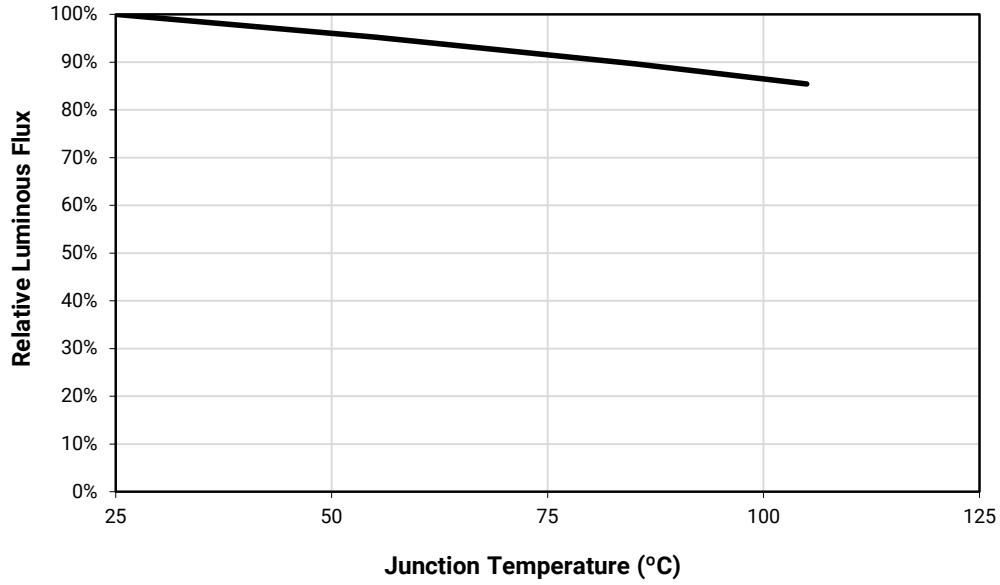

TYPICAL SPATIAL DISTRIBUTION

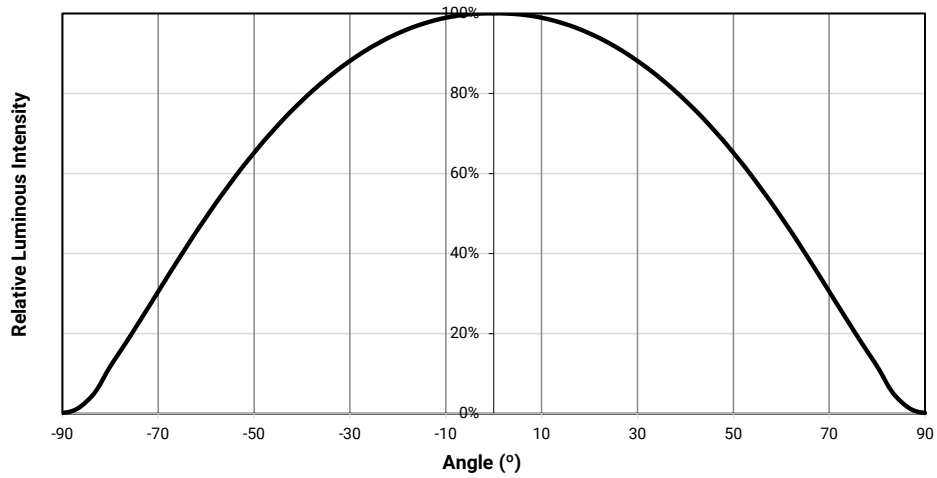

PERFORMANCE GROUPS - LUMINOUS FLUX

J Series 2016 Gen 2 3-V P Class LEDs are tested for luminous flux at 60 mA and placed into one of the following luminous-flux groups.

Group Code	Minimum Luminous Flux (lm)	Maximum Luminous Flux (lm)
B4	16	18
B5	18	20
C2	20	22
C3	22	24
C4	24	26
C5	26	28
D2	28	30
D3	30	32

PERFORMANCE GROUPS - FORWARD VOLTAGE ($T_j = 25\text{ }^\circ\text{C}$)

J Series 2016 Gen 2 3-V P Class LEDs are tested for forward voltage and placed into one of the following voltage bins.

The following voltage bins are used in the bin code Forward Voltage Bin field for 2016 Gen 2 3-V P Class LEDs.

Voltage Bin	Minimum Forward Voltage (V)	Maximum Forward Voltage (V)
AF	2.9	3.0
AG	3.0	3.1
AH	3.1	3.2

PERFORMANCE GROUPS - CHROMATICITY ($T_j = 25\text{ }^\circ\text{C}$)

J Series 2016 Gen 2 3-V P Class LEDs are tested for chromaticity and placed into one of the regions defined by the following bounding coordinates.

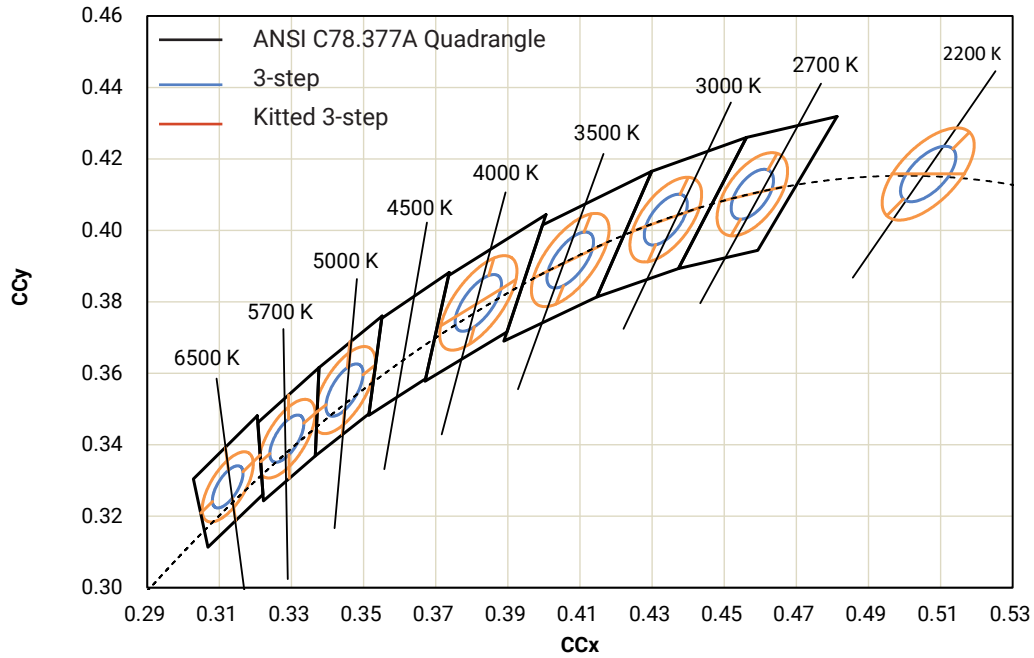

PERFORMANCE GROUPS - CHROMATICITY - CONTINUED ($T_j = 25\text{ °C}$)

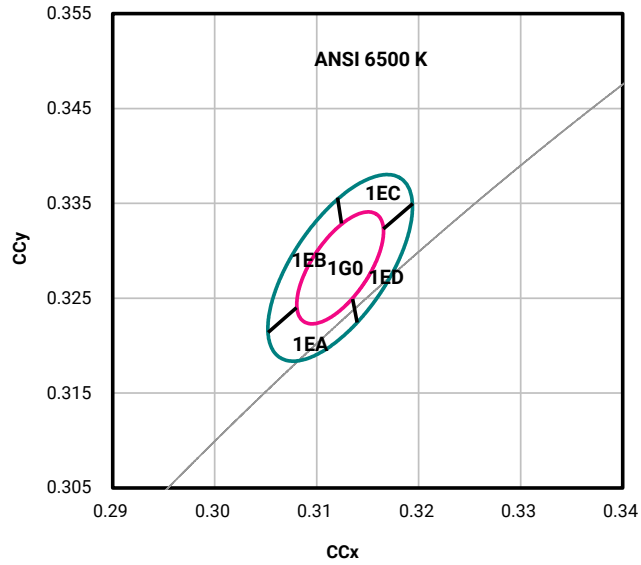

CCT	MacAdam Ellipse	Included Bins	Center Point		Major Axis	Minor Axis	Rotation Angle (°)
			x	y	a	b	
6500 K	3-step	1G0	0.3123	0.3282	0.00669	0.00285	58.57
	Kitted 3-step	1G0, 1EA, 1EB, 1EC, 1ED	0.3123	0.3282	0.01115	0.00475	58.57

PERFORMANCE GROUPS - CHROMATICITY - CONTINUED ($T_j = 25\text{ }^\circ\text{C}$)

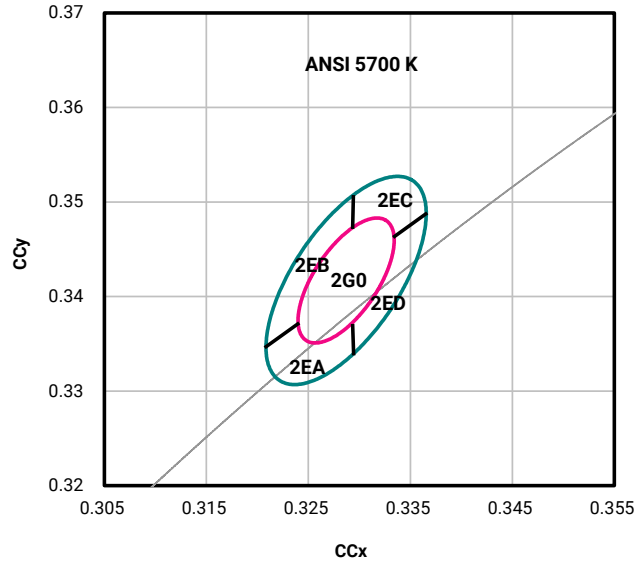

CCT	MacAdam Ellipse	Included Bins	Center Point		Major Axis	Minor Axis	Rotation Angle (°)
			x	y	a	b	
5700 K	3-step	2G0	0.3287	0.3417	0.00746	0.00320	59.09
	Kitted 3-step	2G0, 2EA, 2EB, 2EC, 2ED	0.3287	0.3417	0.01243	0.00533	59.09

PERFORMANCE GROUPS - CHROMATICITY - CONTINUED ($T_j = 25\text{ }^\circ\text{C}$)

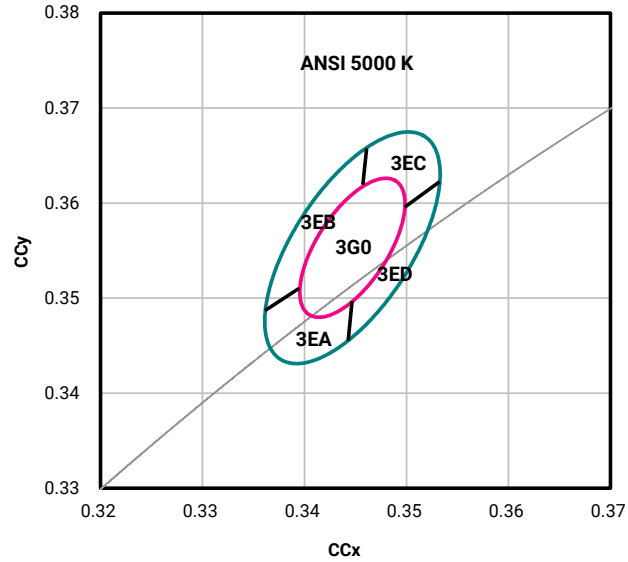

CCT	MacAdam Ellipse	Included Bins	Center Point		Major Axis	Minor Axis	Rotation Angle (°)
			x	y	a	b	
5000 K	3-step	3G0	0.3447	0.3553	0.00822	0.00354	59.62
	Kitted 3-step	3G0, 3EA, 3EB, 3EC, 3ED	0.3447	0.3553	0.01370	0.00590	59.62

PERFORMANCE GROUPS - CHROMATICITY - CONTINUED ($T_j = 25\text{ }^\circ\text{C}$)

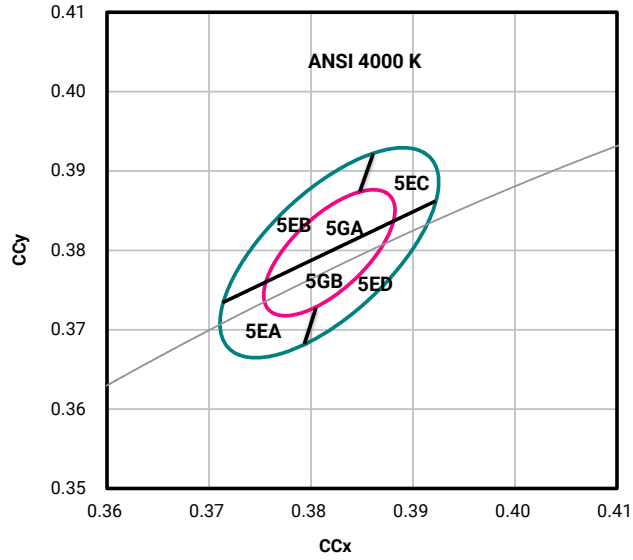

CCT	MacAdam Ellipse	Included Bins	Center Point		Major Axis	Minor Axis	Rotation Angle (°)
			x	y	a	b	
4000 K	3-step	5GA, 5GB	0.3818	0.3797	0.00939	0.00402	53.72
	Kitted 3-step	5GA, 5GB, 5EA, 5EB, 5EC, 5ED	0.3818	0.3797	0.01565	0.00670	53.72

PERFORMANCE GROUPS - CHROMATICITY - CONTINUED ($T_j = 25\text{ }^\circ\text{C}$)

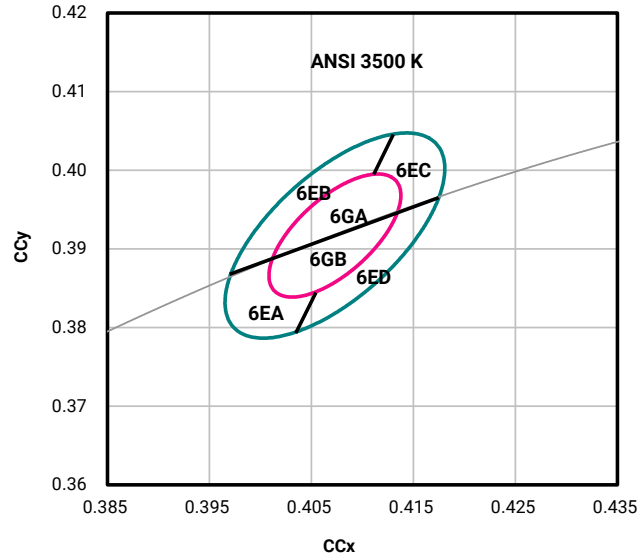

CCT	MacAdam Ellipse	Included Bins	Center Point		Major Axis	Minor Axis	Rotation Angle (°)
			x	y	a	b	
3500 K	3-step	6GA, 6GB	0.4073	0.3917	0.00927	0.00414	53.22
	Kitted 3-step	6GA, 6GB, 6EA, 6EB, 6EC, 6ED	0.4073	0.3917	0.01545	0.00690	53.22

PERFORMANCE GROUPS - CHROMATICITY - CONTINUED ($T_j = 25\text{ }^\circ\text{C}$)

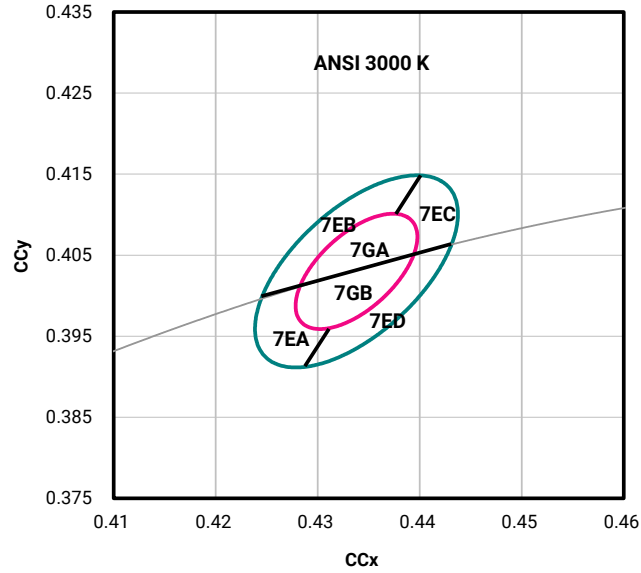

CCT	MacAdam Ellipse	Included Bins	Center Point		Major Axis	Minor Axis	Rotation Angle (°)
			x	y	a	b	
3000 K	3-step	7GA, 7GB	0.4338	0.4030	0.00834	0.00408	53.22
	Kitted 3-step	7GA, 7GB, 7EA, 7EB 7EC, 7ED	0.4338	0.4030	0.01390	0.00680	53.22

PERFORMANCE GROUPS - CHROMATICITY - CONTINUED ($T_j = 25\text{ °C}$)

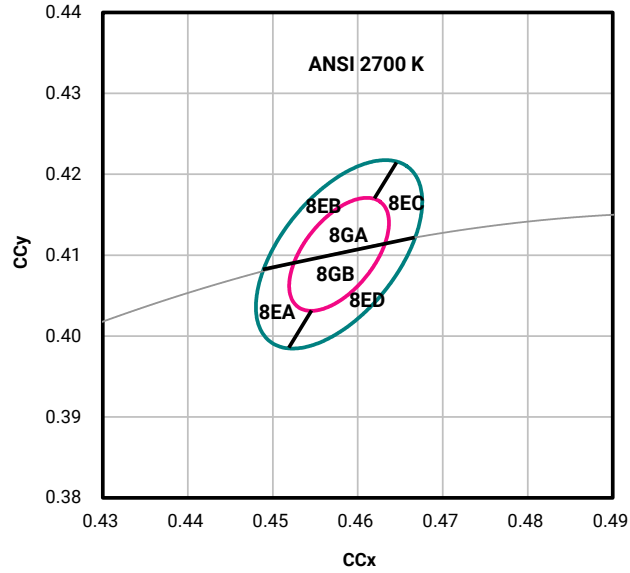

CCT	MacAdam Ellipse	Included Bins	Center Point		Major Axis	Minor Axis	Rotation Angle (°)
			x	y	a	b	
2700 K	3-step	8GA, 8GB	0.4578	0.4101	0.00810	0.00420	53.70
	Kitted 3-step	8GA, 8GB, 8EA, 8EB, 8EC, 8ED	0.4578	0.4101	0.01350	0.00700	53.70

PERFORMANCE GROUPS - CHROMATICITY - CONTINUED ($T_j = 25\text{ }^\circ\text{C}$)

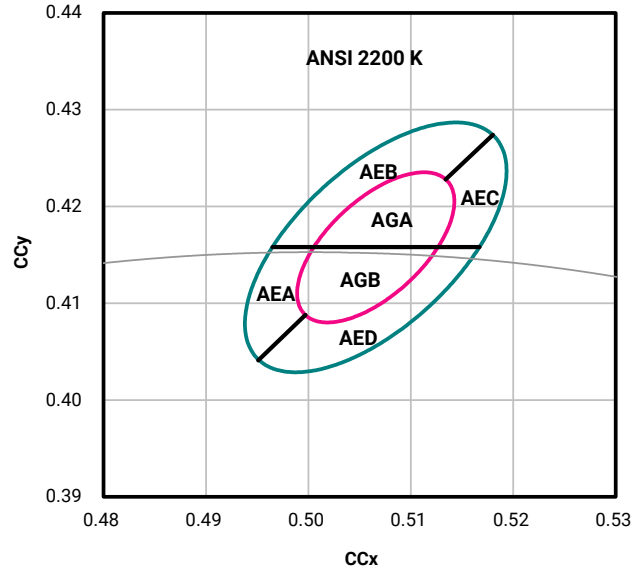

CCT	MacAdam Ellipse	Included Bins	Center Point		Major Axis	Minor Axis	Rotation Angle (°)
			x	y	a	b	
2200 K	3-step	AGA, AGB	0.5066	0.4158	0.0098	0.0048	45.5
	Kitted 3-step	AGA, AGB, AEA, AEB, AEC, AED	0.5066	0.4158	0.0163	0.0080	45.5

REFLOW SOLDERING CHARACTERISTICS

In testing, Cree Venture has found J Series 2016 Gen 2 3-V P Class LEDs to be compatible with JEDEC J-STD-020C, using the parameters listed below. As a general guideline, Cree Venture recommends that users follow the recommended soldering profile provided by the manufacturer of the solder paste used, and therefore it is the lamp or luminaire manufacturer’s responsibility to determine applicable soldering requirements.

Note that this general guideline may not apply to all PCB designs and configurations of reflow soldering equipment.

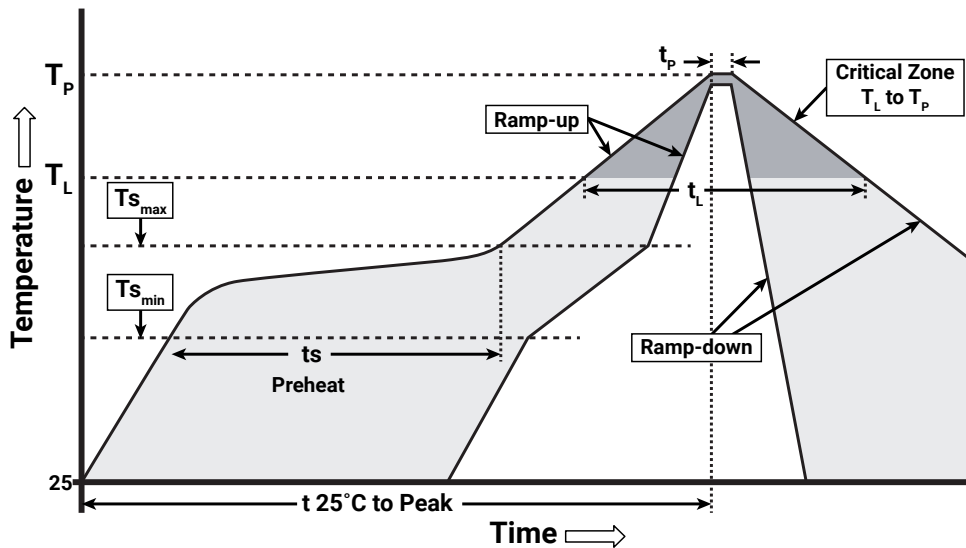

IPC/JEDEC J-STD-020C

Profile Feature	Lead-Free Solder
Temperature Min. ($T_{s_{min}}$)	150 °C
Temperature Max. ($T_{s_{max}}$)	200 °C
Time (ts) from $T_{s_{min}}$ to $T_{s_{max}}$	60-120 seconds
Ramp-Up Rate (T_L to T_P)	3 °C/second
Liquidus Temperature (T_L)	217 °C
Time (t_L) Maintained Above T_L	60-150 seconds
Peak Package Body Temperature (T_P)	260 °C max.
Time (t_p) Within 5 °C of the Specified Classification Temperature (T_c)	30 seconds max.
Ramp-Down Rate (T_P to T_L)	6 °C/second max.
Time 25 °C to Peak Temperature	8 minutes max.

Note: All temperatures refer to the topside of the package, measured on the package body surface.

NOTES

Measurements

The luminous flux, radiant power, chromaticity, forward voltage and CRI measurements in this document are binning specifications only and solely represent product measurements as of the date of shipment. These measurements will change over time based on a number of factors that are not within Cree Venture’s control and are not intended or provided as operational specifications for the products. Calculated values are provided for informational purposes only and are not intended or provided as specifications.

Pre-Release Qualification Testing

Please read the [J Series Reliability Overview](#) for the details of the pre-release qualification testing for J Series LEDs.

Lumen Maintenance

Cree Venture uses standardized IES LM-80-08 and TM-21-11 methods for collecting long-term data and extrapolating LED lumen maintenance. For information on the specific LM-80 data sets available for this LED, refer to the public [J Series LM-80 results document](#).

Please read the [Thermal Management application note](#) for details on how thermal design, ambient temperature, and drive current affect the LED junction temperature.

Moisture Sensitivity

Cree Venture recommends keeping J Series 2016 Gen 2 3-V P Class LEDs in the provided, resealable moisture-barrier packaging (MBP) until immediately prior to soldering. Unopened MBP that contains J Series 2016 Gen 2 3-V P Class LEDs does not need special storage for moisture sensitivity.

Once the MBP is opened, J Series 2016 Gen 2 3-V P Class LEDs should be handled and stored as MSL 3 per JEDEC J-STD-033, meaning they have limited exposure time before damage to the LED may occur during the soldering operation. The table on the right specifies the maximum exposure time in days depending on temperature and humidity conditions. LEDs with exposure time longer than the specified maximums must be baked according to the baking conditions listed below.

Moisture Sensitivity Level	Temp.	Maximum Percent Relative Humidity				
		50%	60%	70%	80%	90%
Level 3	35 °C	8	5	1	0.5	0.5
Level 3	30 °C	11	7	1	1	1
Level 3	25 °C	14	10	2	1	1
Level 3	20 °C	20	13	2	1	1

Baking Conditions

It is not necessary to bake all J Series 2016 Gen 2 3-V P Class LEDs. Only the LEDs that meet all of the following criteria must be baked:

1. LEDs that have been removed from the original MBP.
2. LEDs that have been exposed to a humid environment longer than listed in the Moisture Sensitivity section above.
3. LEDs that have not been soldered.

LEDs should be baked at 60 °C for 24 hours. LEDs may be baked on the original reels. Remove LEDs from the MBP before baking. Do not bake parts at temperatures higher than 60 °C. This baking operation resets the exposure time as defined in the Moisture Sensitivity section above.

NOTES - CONTINUED

RoHS Compliance

The levels of RoHS restricted materials in this product are below the maximum concentration values (also referred to as the threshold limits) permitted for such substances, or are used in an exempted application, in accordance with EU Directive 2011/65/EC (RoHS2), as implemented January 2, 2013. RoHS Declarations for this product can be obtained from your Cree representative or from the [Product Ecology](#) section of the Cree website.

REACH Compliance

REACH substances of very high concern (SVHCs) information is available for this product. Since the European Chemical Agency (ECHA) has published notice of their intent to frequently revise the SVHC listing for the foreseeable future, please contact a Cree representative to insure you get the most up-to-date REACH SVHC Declaration. REACH banned substance information (REACH Article 67) is also available upon request.

UL® Recognized Component

This product meets the requirements to be considered a UL Recognized Component with Level 4 enclosure consideration. The LED package or a portion thereof has been investigated as a fire and electrical enclosure per ANSI/UL 8750.

Vision Advisory

WARNING: Do not look at an exposed lamp in operation. Eye injury can result. For more information about LEDs and eye safety, please refer to the [J Series LED Eye Safety application note](#).

MECHANICAL DIMENSIONS

Thermal vias, if present, are not shown on these drawings.
 All measurements are ± 0.2 mm unless otherwise indicated.

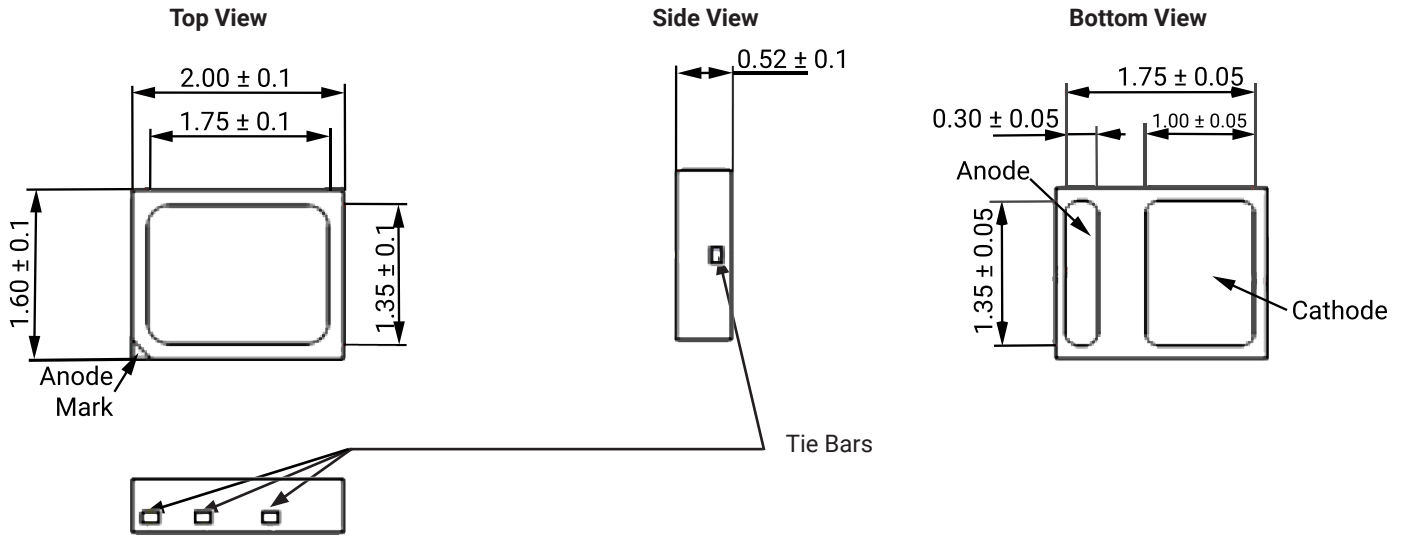

All measurements are ± 0.1 mm unless otherwise indicated.

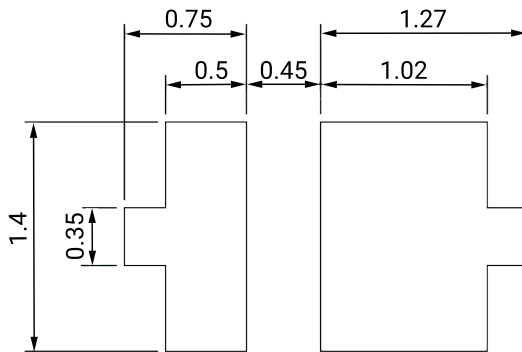

Recommended Solder Pad

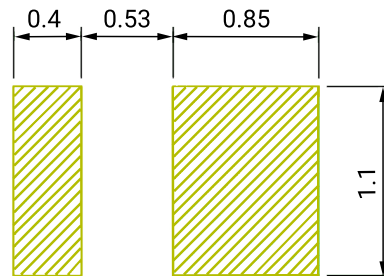

**Recommended Stencil Pattern
 (Shaded Area Is Open)**

TAPE & REEL

All Cree Venture carrier tapes conform to EIA-481D, Automated Component Handling Systems Standard.

All dimensions in mm.

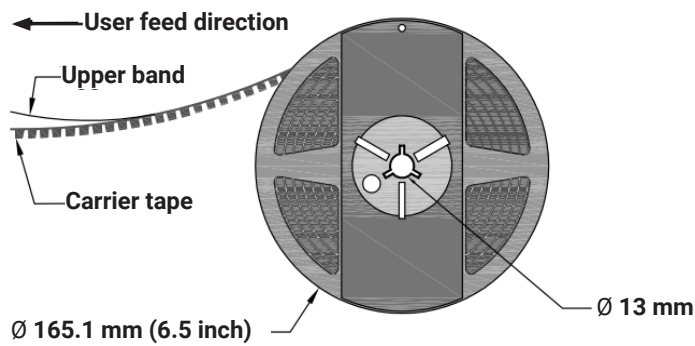
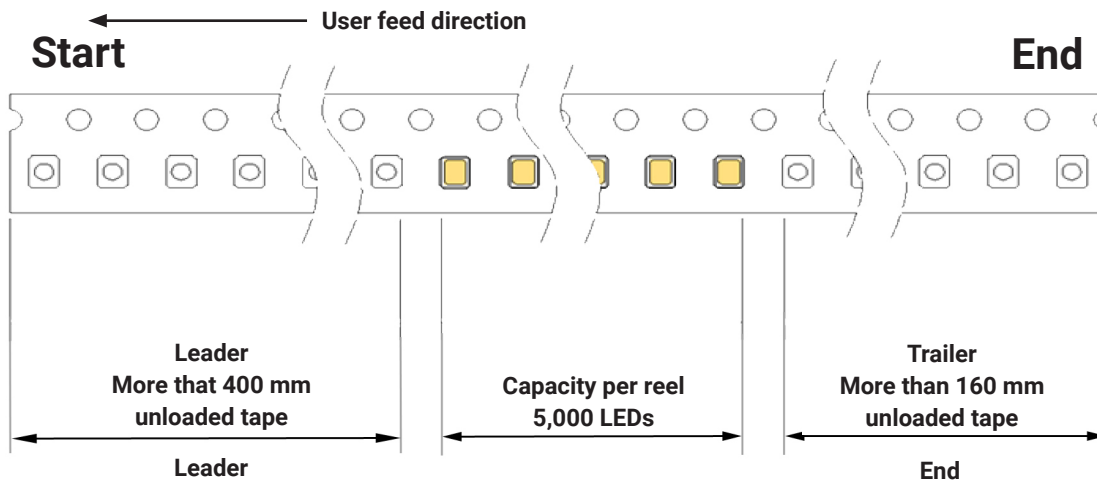
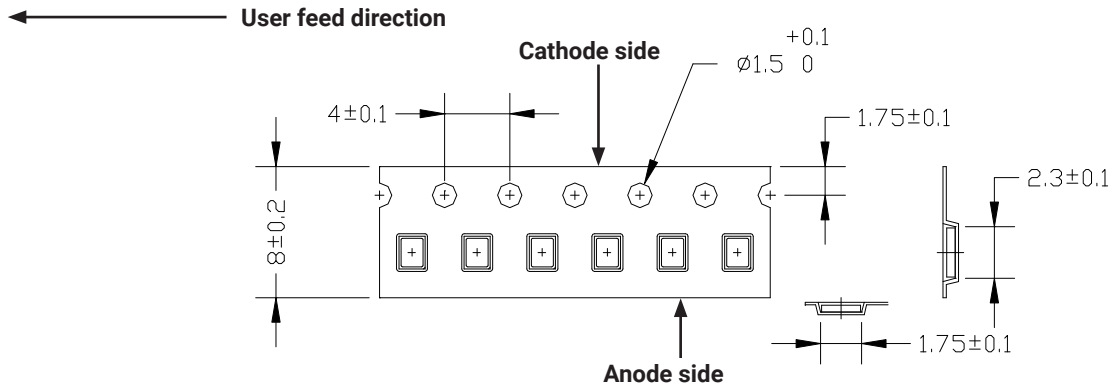

PACKAGING

Unpackaged Reel

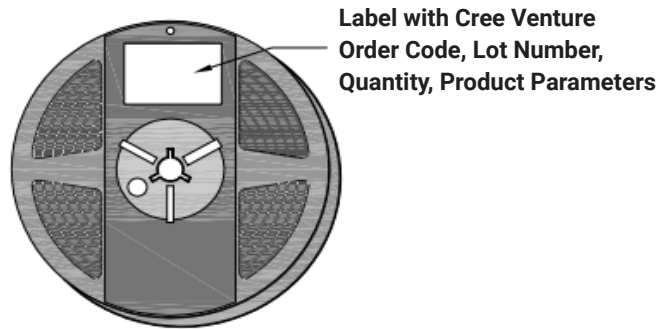

Packaged Reel

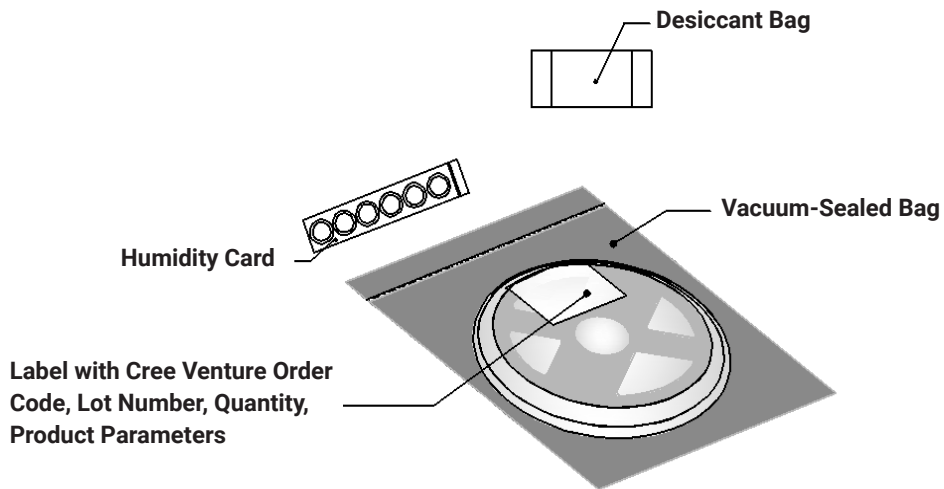

PACKAGING - CONTINUED

J Series 2016 Gen 2 3-V P Class LEDs are packaged in boxes for shipment. Box sizes and the number of reels per box are as follows.

Box	Box Dimensions	Maximum Number of Reels per Box
1	250 x 210 x 30 mm	2
2	250 x 210 x 50 mm	4
3	530 x 230 x 275 mm	44
4	530 x 443 x 275 mm	88

Each box has at least one label (shown as a white square in the diagrams below) showing the order code, lot number, quantity, and product parameters.

Box 1

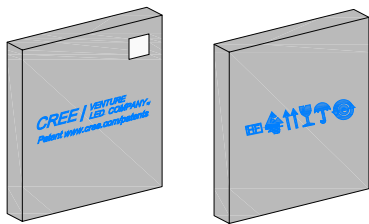

Box 2

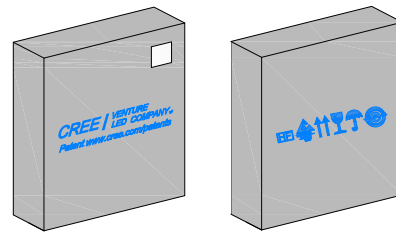

Box 3

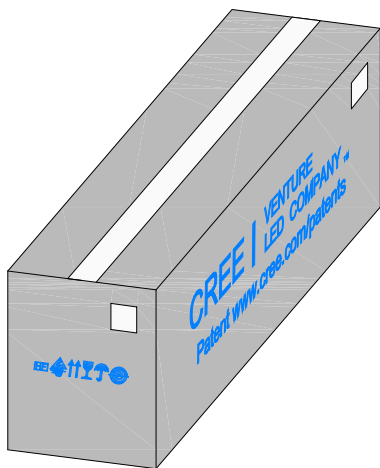

Box 4

