

V_{DS}	1200 V
I_{DS}	20 A

CCS020M12CM2

1200 V, 20 A All-Silicon Carbide Six-Pack (Three Phase) Module

Technical Features

- Ultra-Low Loss
- High-Frequency Operation
- Zero Reverse Recovery from Diodes
- Zero Turn-off Tail Current from MOSFET
- Normally-off, Fail-safe Device Operation
- Copper Baseplate and Aluminum Nitride Insulator

Package 45 mm X 107.5 mm X 20.5 mm

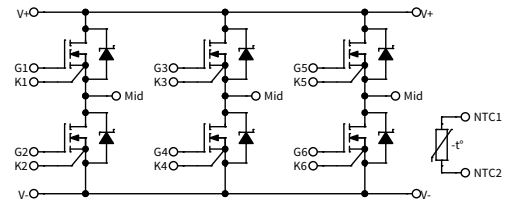

Applications

- 3-Phase PFC
- Regen Drive
- Solar & Renewable Energy
- Industrial Automation & Testing
- Motor Drive

System Benefits

- Fast Time-to-Market with Minimal Development Required for Transition from 45mm IGBT Packages
- Increased System Efficiency, due to Low Switching & Conduction Losses of SiC
- Enables Compact and Lightweight Systems

Maximum Parameters (Verified by Design)

Symbol	Parameter	Min.	Typ.	Max.	Unit	Test Conditions	Note
$V_{DS\ max}$	Drain-Source Voltage			1200	V		
$V_{GS\ max}$	Gate-Source Voltage, Maximum Value	-10		+25		Transient, <100 ns	Fig. 33
$V_{GS\ op}$	Gate-Source Voltage, Recommended Op. Value	-5		+20		Static	
I_{DS}	DC Continuous Drain-Source Current		34		A	$V_{GS} = 20\ V, T_C = 25\ ^\circ C, T_{VJ} \leq 150\ ^\circ C$	Fig. 21
			23			$V_{GS} = 20\ V, T_C = 90\ ^\circ C, T_{VJ} \leq 150\ ^\circ C$	
I_{SD}	DC Continuous Source-Drain Current		57			$V_{GS} = 20\ V, T_C = 25\ ^\circ C, T_{VJ} \leq 150\ ^\circ C$	
I_F	Schottky Diode DC Forward Current		49			$V_{GS} = -5\ V, T_C = 25\ ^\circ C, T_{VJ} \leq 150\ ^\circ C$	
$I_{DS\ (pulsed)}$	Maximum Pulsed Drain-Source Current		80			$V_{GS} = 20\ V$	$T_{VJ} = 25\ ^\circ C;$ t_{pmax} limited by T_{VJmax}
$I_F\ (pulsed)$	Maximum Pulsed Diode Current		98			$V_{GS} = -5\ V$	
$T_{VJ\ op}$	Maximum Virtual Junction Temperature under Switching Conditions	-40		150	$^\circ C$		

MOSFET Characteristics (Per Position) ($T_{vj} = 25^\circ\text{C}$ unless otherwise specified)

Symbol	Parameter	Min.	Typ.	Max.	Unit	Test Conditions	Note
$V_{(BR)DSS}$	Drain-Source Breakdown Voltage	1200			V	$V_{GS} = 0\text{ V}, T_{vj} = -40^\circ\text{C}$	
$V_{GS(th)}$	Gate Threshold Voltage	1.7	2.2			$V_{DS} = V_{GS}, I_D = 1\text{ mA}$	
I_{DSS}	Zero Gate Voltage Drain Current		40	300	μA	$V_{GS} = 0\text{ V}, V_{DS} = 1200\text{ V}$	
I_{GSS}	Gate-Source Leakage Current			0.25		$V_{GS} = 20\text{ V}, V_{DS} = 0\text{ V}$	
$R_{DS(on)}$	Drain-Source On-State Resistance (Devices Only)		80	98	m Ω	$V_{GS} = 20\text{ V}, I_D = 20\text{ A}$	Fig. 2 Fig. 3
			145			$V_{GS} = 20\text{ V}, I_D = 20\text{ A}, T_{vj} = 150^\circ\text{C}$	
g_{fs}	Transconductance		10		S	$V_{DS} = 20\text{ V}, I_{DS} = 20\text{ A}$	Fig. 4
			9			$V_{DS} = 20\text{ V}, I_{DS} = 20\text{ A}, T_{vj} = 150^\circ\text{C}$	
E_{On}	Turn-On Switching Energy, $T_{vj} = 25^\circ\text{C}$ $T_{vj} = 125^\circ\text{C}$ $T_{vj} = 150^\circ\text{C}$		68		μJ	$V_{DS} = 600\text{ V},$ $I_D = 20\text{ A},$ $V_{GS} = -5\text{ V}/+20\text{ V},$ $R_{G(ext)} = 2.0\ \Omega,$ $L = 130\ \mu\text{H}$	Fig. 11 Fig. 13
			58				
			57				
E_{Off}	Turn-Off Switching Energy, $T_{vj} = 25^\circ\text{C}$ $T_{vj} = 125^\circ\text{C}$ $T_{vj} = 150^\circ\text{C}$		45		μJ	$V_{DS} = 600\text{ V},$ $I_D = 20\text{ A},$ $V_{GS} = -5\text{ V}/+20\text{ V},$ $R_{G(ext)} = 2.0\ \Omega,$ $L = 130\ \mu\text{H}$	Fig. 11 Fig. 13
			81				
			84				
$R_{G(int)}$	Internal Gate Resistance		3.8		Ω	$V_{AC} = 25\text{ mV}, f = 100\text{ kHz}$	
C_{iss}	Input Capacitance		1.18		nF	$V_{GS} = 0\text{ V}, V_{DS} = 800\text{ V},$ $V_{AC} = 25\text{ mV}, f = 1\text{ MHz}$	Fig. 9
C_{oss}	Output Capacitance		0.37				
C_{rss}	Reverse Transfer Capacitance		9.4		μF		
Q_{GS}	Gate to Source Charge		17		nC	$V_{DS} = 800\text{ V}, V_{GS} = -5\text{ V}/+20\text{ V}$ $I_D = 20\text{ A}$ Per IEC60747-8-4 pg 21	
Q_{GD}	Gate to Drain Charge		29				
Q_G	Total Gate Charge		71				
$R_{th(jc)}$	FET Thermal Resistance, Junction to Case		0.7	0.75	$^\circ\text{C}/\text{W}$		Fig. 17



Diode Characteristics (Per Position) ($T_{VJ} = 25^\circ\text{C}$ unless otherwise specified)

Symbol	Parameter	Min.	Typ.	Max.	Unit	Test Conditions	Note
V_F	Diode Forward Voltage		1.5		V	$V_{GS} = -5\text{ V}, I_F = 20\text{ A}, T_{VJ} = 25^\circ\text{C}$	Fig. 7
			2.2			$V_{GS} = -5\text{ V}, I_F = 20\text{ A}, T_{VJ} = 150^\circ\text{C}$	
t_{rr}	Reverse Recovery Time		13		ns	$V_{GS} = -5\text{ V}, I_{SD} = 20\text{ A}, V_R = 600\text{ V}$ $di_F/dt = 10\text{ A/ns}, T_{VJ} = 150^\circ\text{C}$	Fig. 32 Note 1
Q_{RR}	Reverse Recovery Charge		370		nC		
I_{RRM}	Peak Reverse Recovery Current		-42		A		
E_{rr}	Diode Energy $T_{VJ} = 25^\circ\text{C}$ $T_{VJ} = 125^\circ\text{C}$ $T_{VJ} = 150^\circ\text{C}$		195		μJ	$V_{DS} = 600\text{ V}, I_D = 20\text{ A},$ $V_{GS} = -5\text{ V}/+20\text{ V}, R_{G(\text{ext})} = 2.0\ \Omega,$ $L = 130\ \mu\text{H}$	Fig. 14 Note 1
			192				
			191				
R_{thJC}	Diode Thermal Resistance, Junction to Case		0.8	0.85	$^\circ\text{C/W}$		Fig. 18

Note 1 SiC Schottky diodes do not have reverse recovery energy but still contribute capacitive energy

Module Physical Characteristics

Symbol	Parameter	Min.	Typ.	Max.	Unit	Test Conditions
L_{Stray}	Stray Inductance		30		nH	Between Terminals 1 and 3
T_C	Case Temperature	-40		125	$^\circ\text{C}$	
W	Weight			180	g	
M_s	Mounting Torque	4	5	5.5	N-m	Baseplate to heatsink
V_{isol}	Case Isolation Voltage	5			kV	AC, 50 Hz, 1 min
	Clearance Distance	6.5			mm	Terminal to Terminal
		15.6				Terminal to Baseplate
		8.6				Terminal to Mounting Bolt
		11.8				Terminal to Isolated NTC Pin
	Creepage Distance	11.9				Terminal to Terminal
		15.6				Terminal to Baseplate
		19.1				Terminal to Mounting Bolt
		16.7				Terminal to Isolated NTC Pin

NTC Characteristics

Symbol	Parameter	Typ.	Max.	Unit	Test Conditions
R_{25}	Rated Resistance	5		k Ω	$T_{NTC} = 25^\circ\text{C}$
$\Delta R/R$	Tolerance		± 5	%	$T_{NTC} = 100^\circ\text{C}, R_{100} = 481\ \Omega$
P_{25}	Maximum Power Dissipation		20	mW	$T_{NTC} = 25^\circ\text{C}$
$B_{25/50}$	NTC Beta Constant	3380		K	$R_2 = R_{25} \exp[B_{25/50}(1/T_2 - 1/(298.15\text{K}))]$



Typical Performance

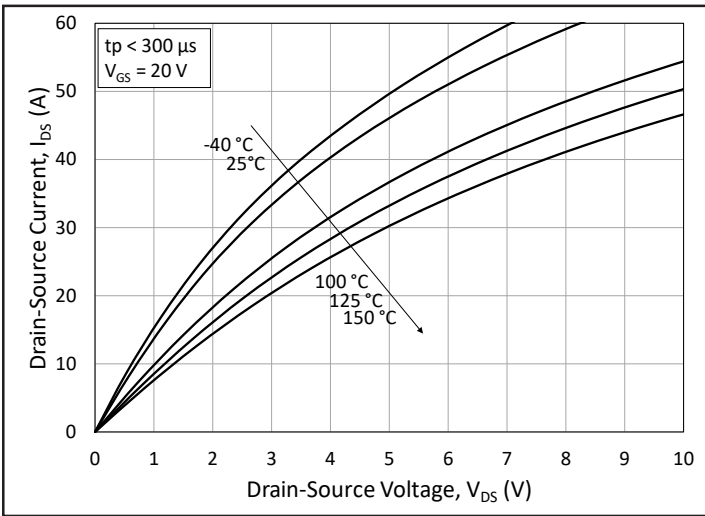

Figure 1. Output Characteristics for Various Junction Temperatures

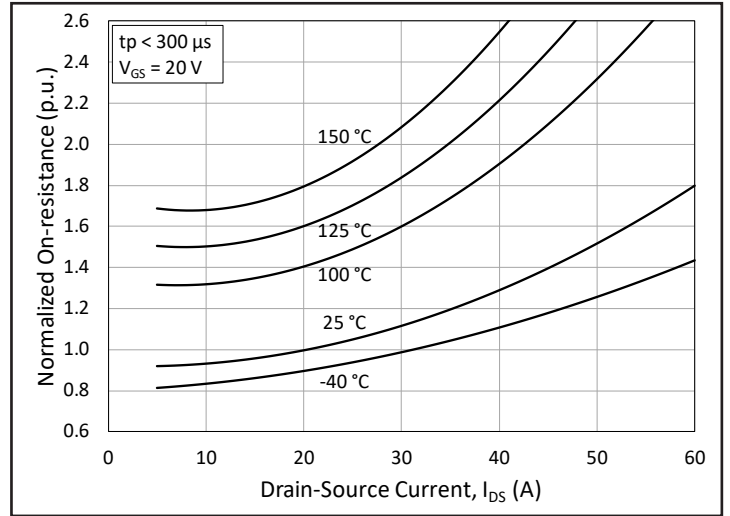

Figure 2. Normalized On-State Resistance vs. Drain Current for Various Junction Temperatures

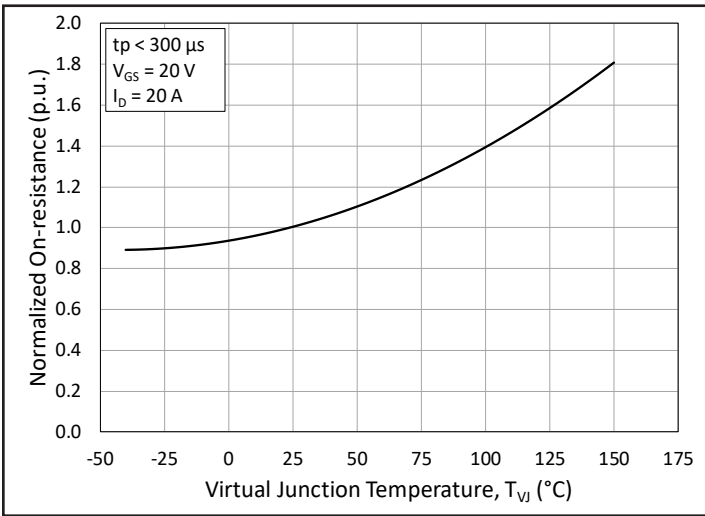

Figure 3. Normalized On-State Resistance vs. Junction Temperature

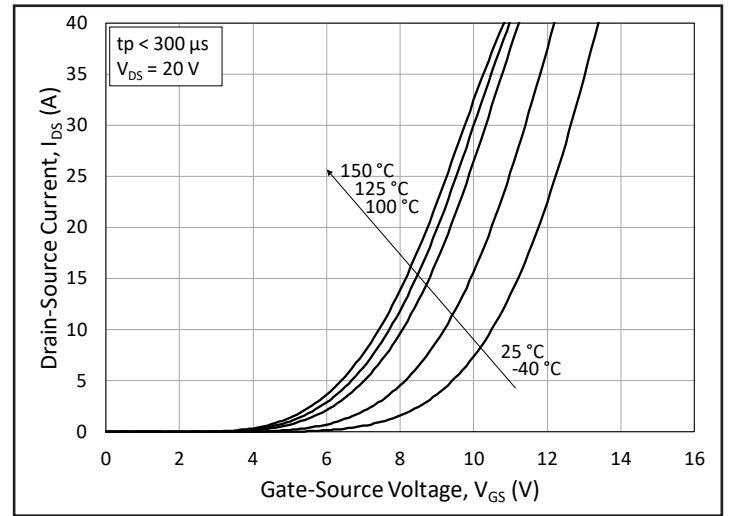

Figure 4. Transfer Characteristic for Various Junction Temperatures

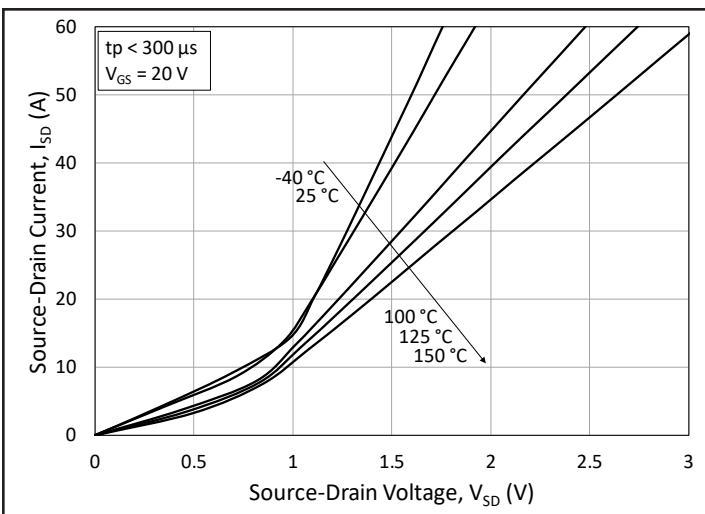

Figure 5. 3rd Quadrant Characteristic vs. Junction Temperatures at $V_{GS} = 20\text{ V}$

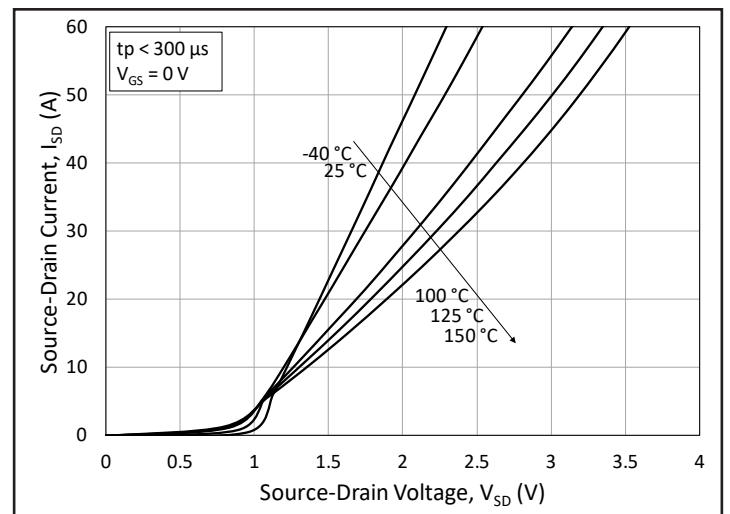

Figure 6. 3rd Quadrant Characteristic vs. Junction Temperatures at $V_{GS} = 0\text{ V}$ (Diode)

Typical Performance

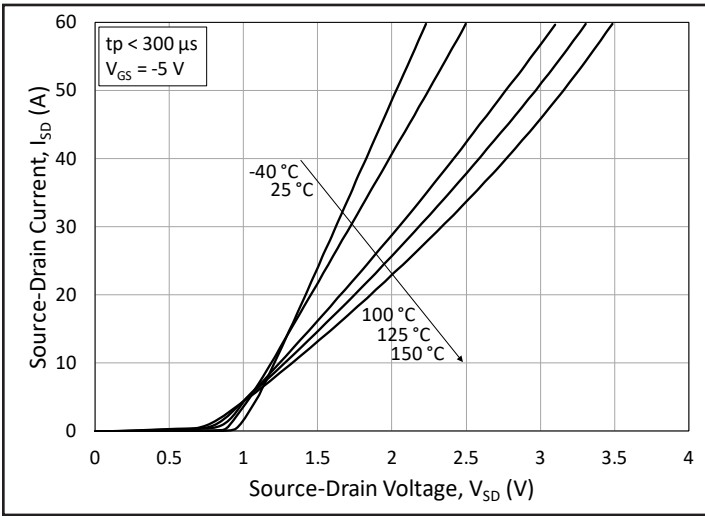

Figure 7. 3rd Quadrant Characteristic vs. Junction Temperatures at $V_{GS} = -5$ V (Diode)

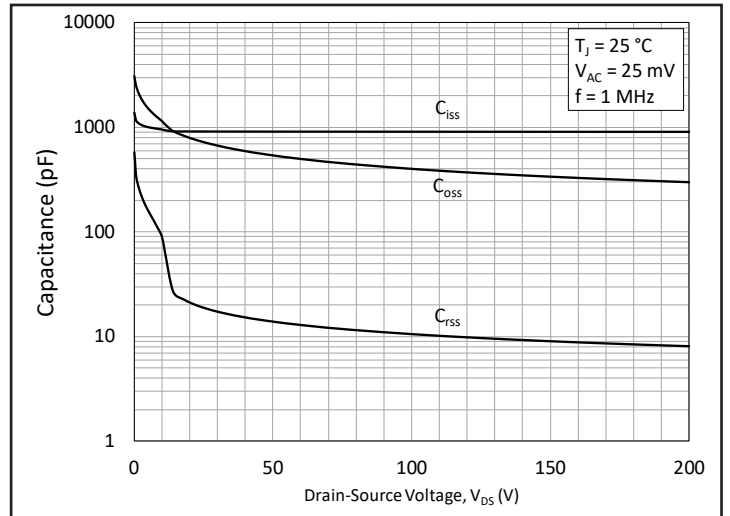

Figure 8. Typical Capacitances vs. Drain to Source Voltage (0 - 200V)

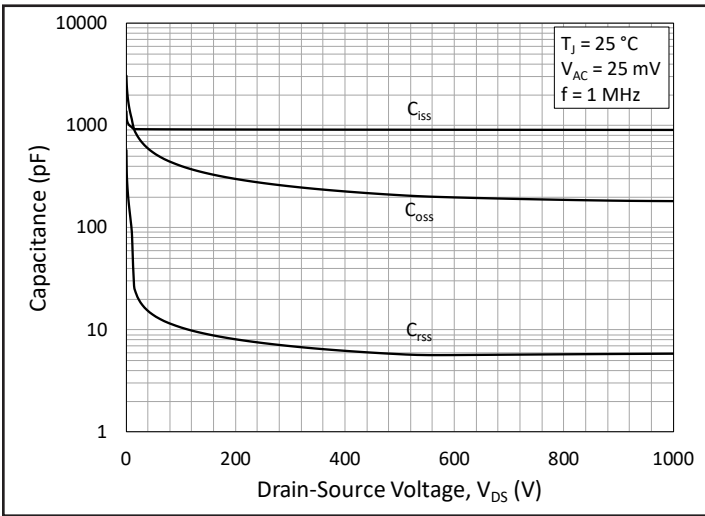

Figure 9. Typical Capacitances vs. Drain to Source Voltage (0 - 1200V)

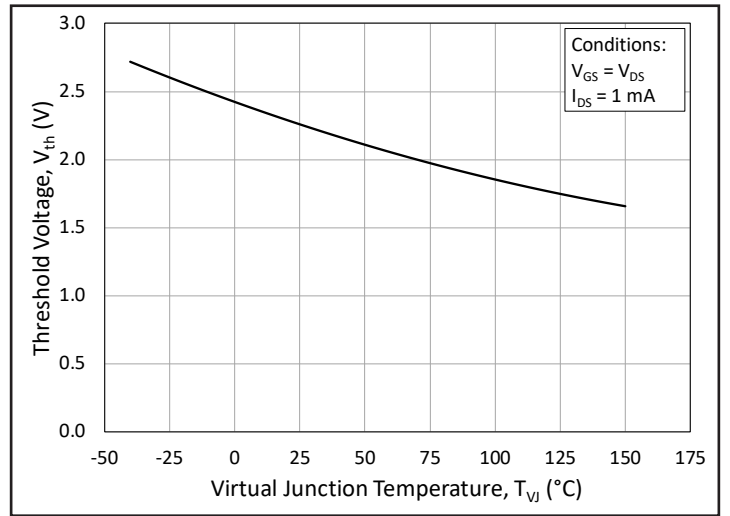

Figure 10. Threshold Voltage vs. Junction Temperature

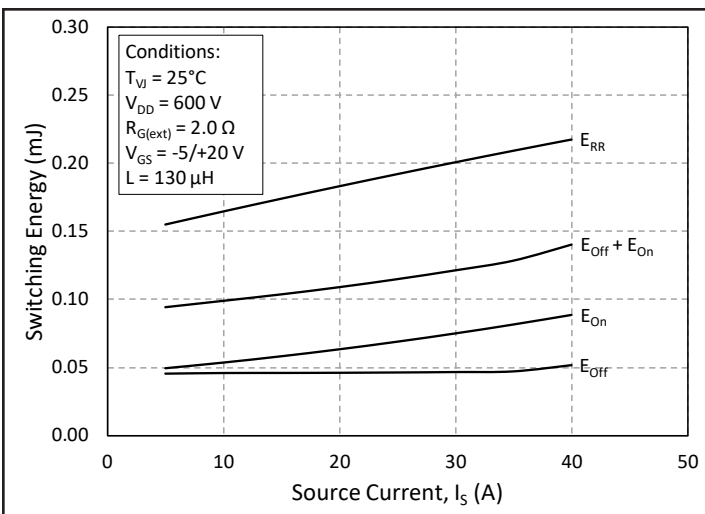

Figure 11. Switching Energy vs. Drain Current ($V_{DS} = 600$ V)

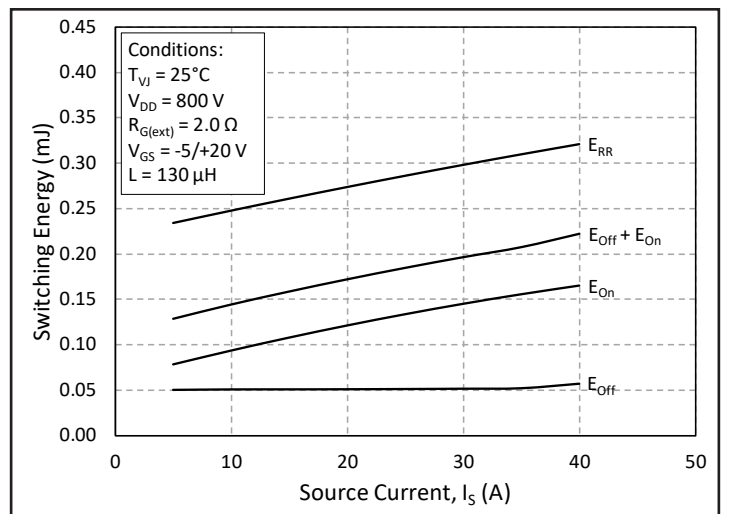

Figure 12. Switching Energy vs. Drain Current ($V_{DS} = 800$ V)

Typical Performance

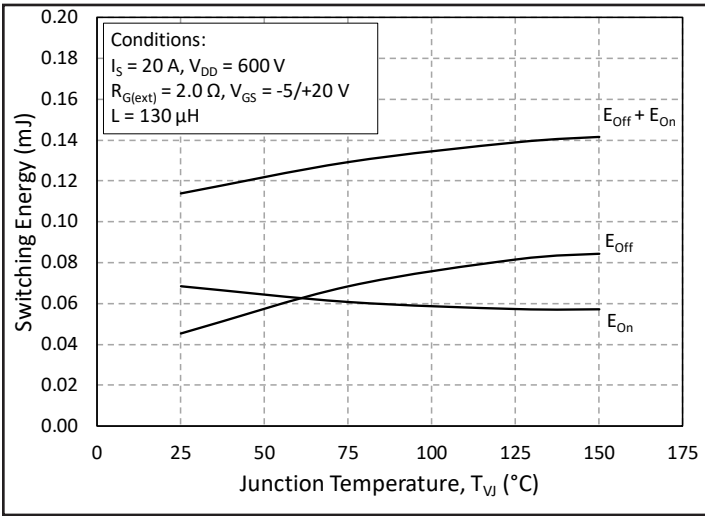

Figure 13. MOSFET Switching Energy vs. Junction Temperature

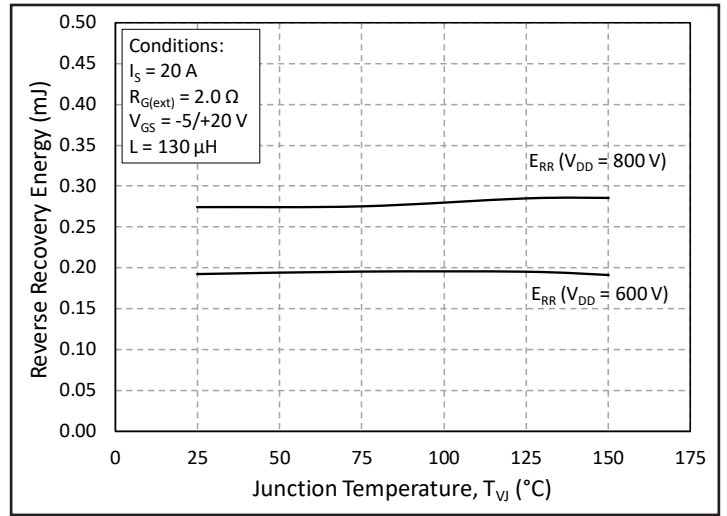

Figure 14. Reverse Recovery Energy vs. Junction Temperature (Note 1)

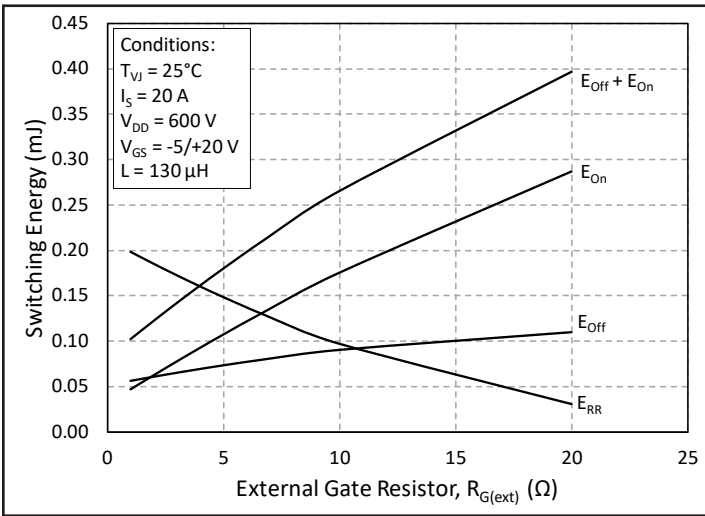

Figure 15. MOSFET Switching Energy vs. External Gate Resistance

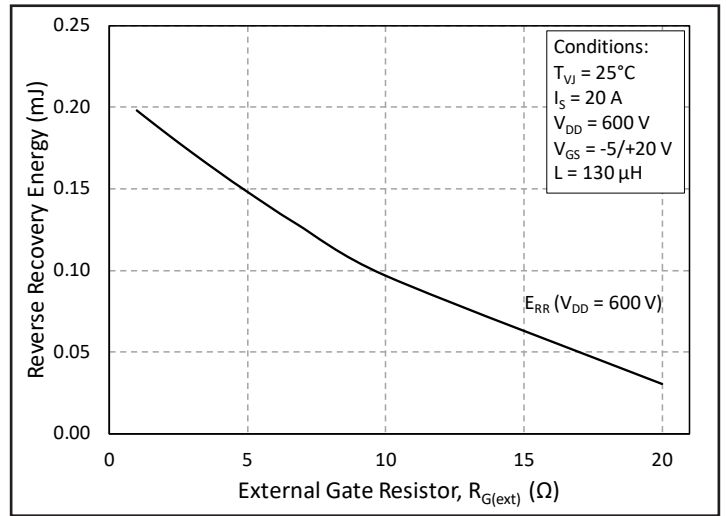

Figure 16. Reverse Recovery Energy vs. External Gate Resistance (Note 1)

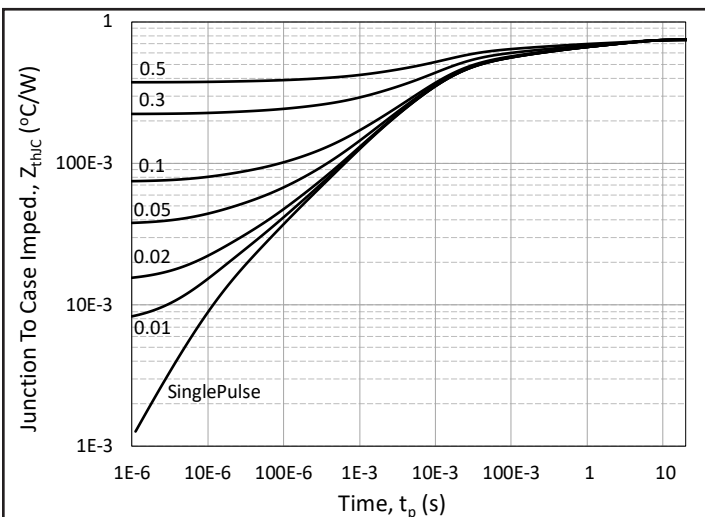

Figure 17. MOSFET Junction to Case Transient Thermal Impedance, Z_{thJC} (°C/W)

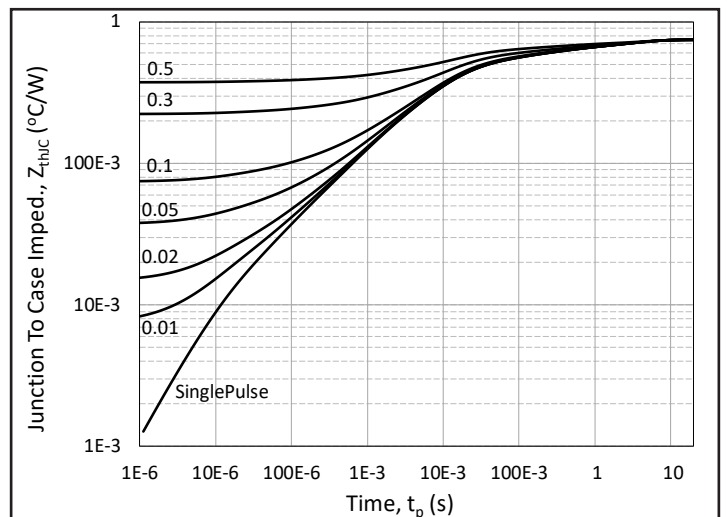

Figure 18. Diode Junction to Case Transient Thermal Impedance, Z_{thJC} (°C/W)



Typical Performance

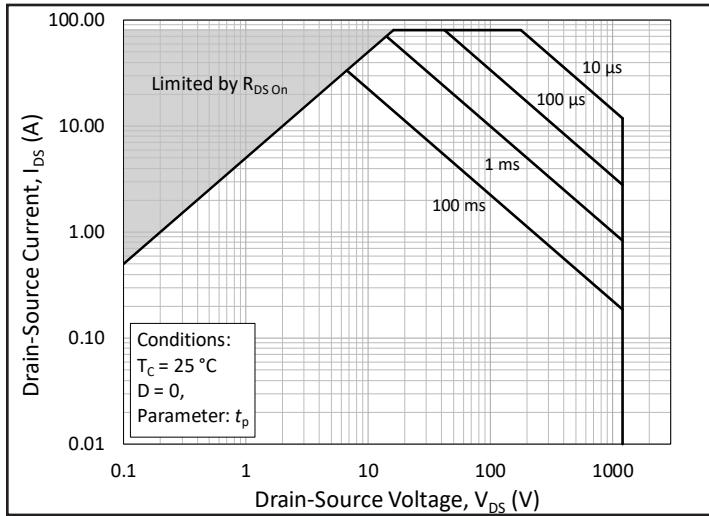

Figure 19. Forward Bias Safe Operating Area (FBSOA)

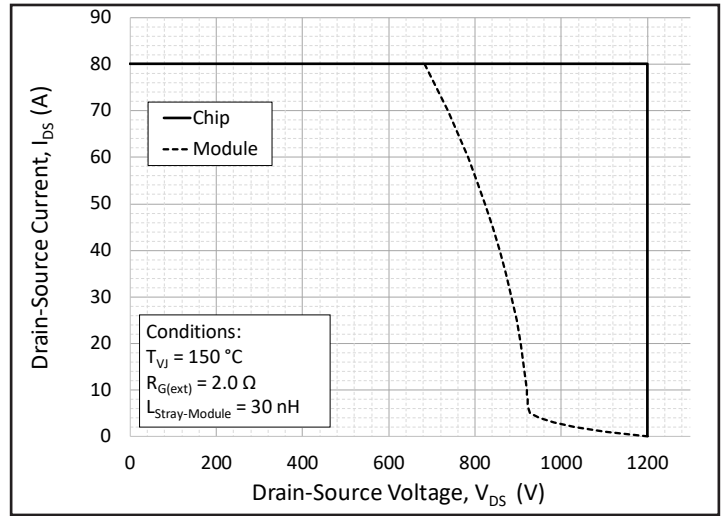

Figure 20. Reverse Bias Safe Operating Area (RBSOA)

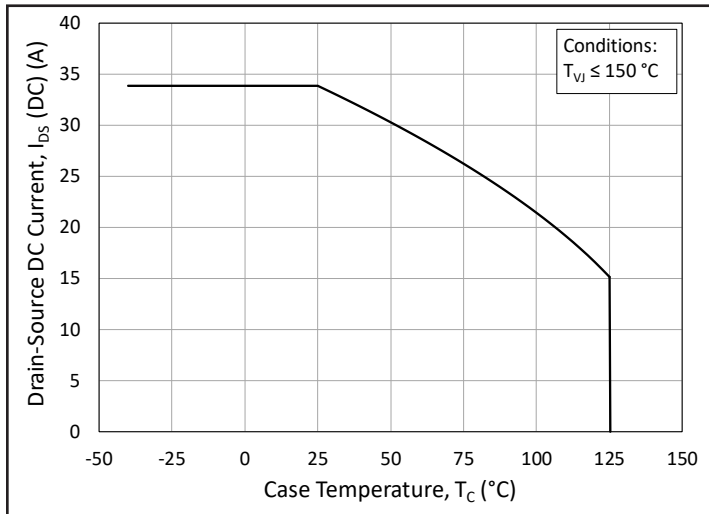

Figure 21. Continuous Drain Current Derating vs. Case Temperature

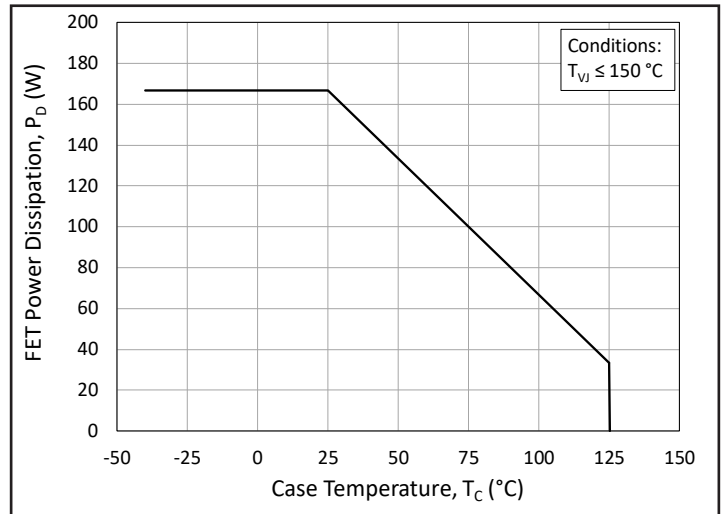

Figure 22. Maximum Power Dissipation Derating vs. Case Temperature

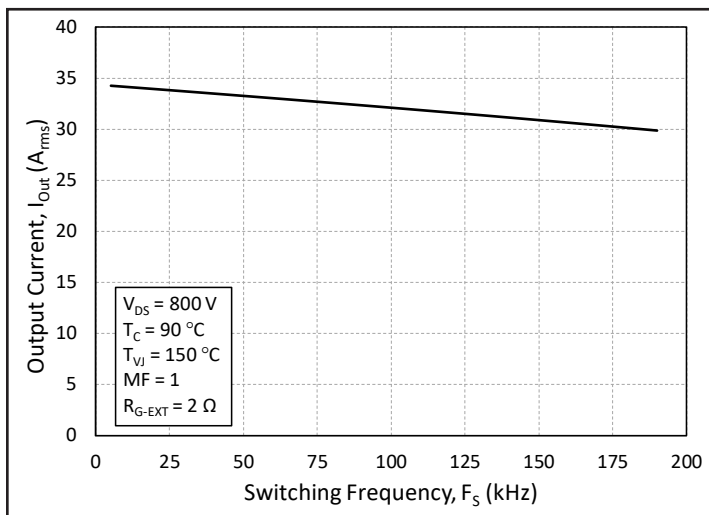

Figure 23. Typical Output Current Capability vs. Switching Frequency (Inverter Application)



Timing Characteristics

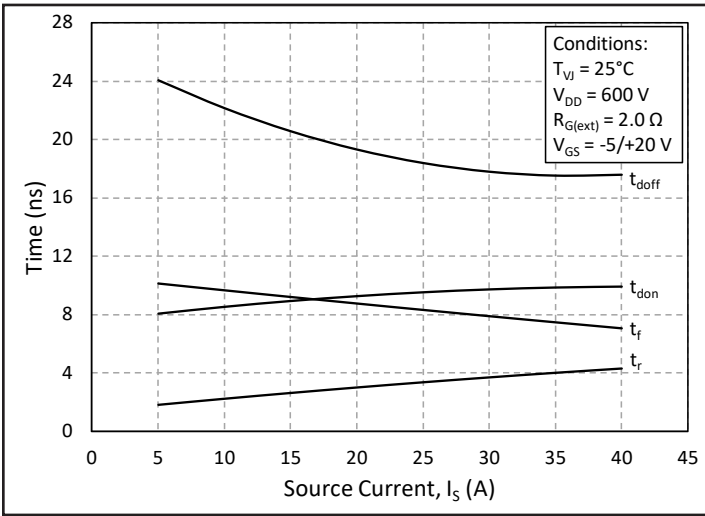

Figure 24. Timing vs. Source Current

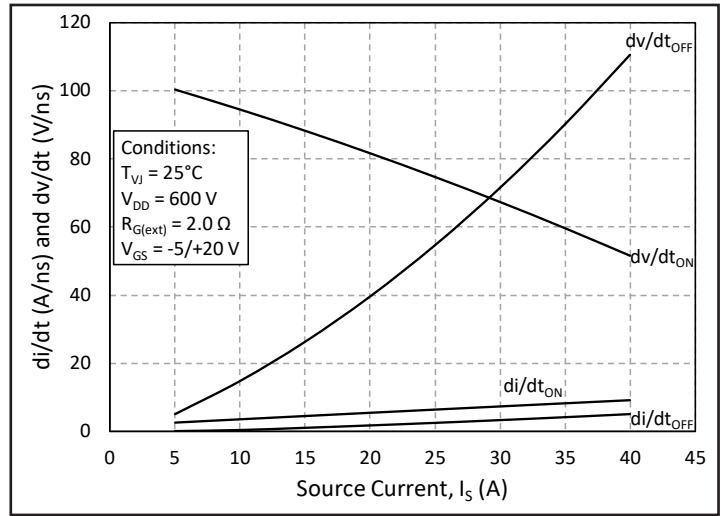

Figure 25. dv/dt and di/dt vs. Source Current

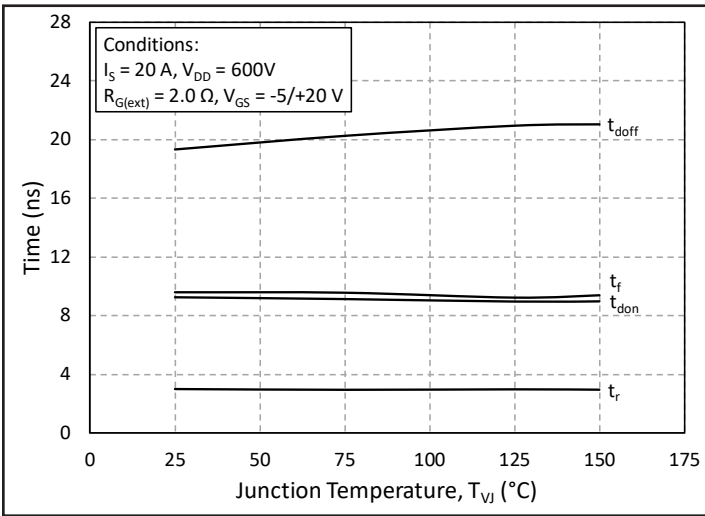

Figure 26. Timing vs. Junction Temperature

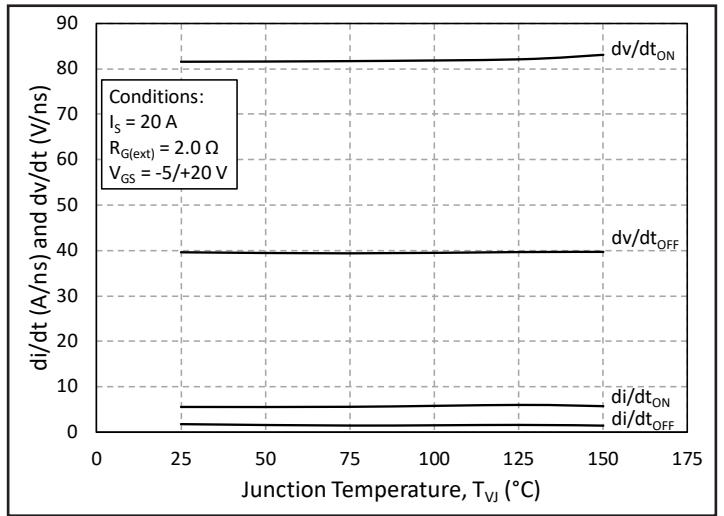

Figure 27. dv/dt and di/dt vs. Source Current

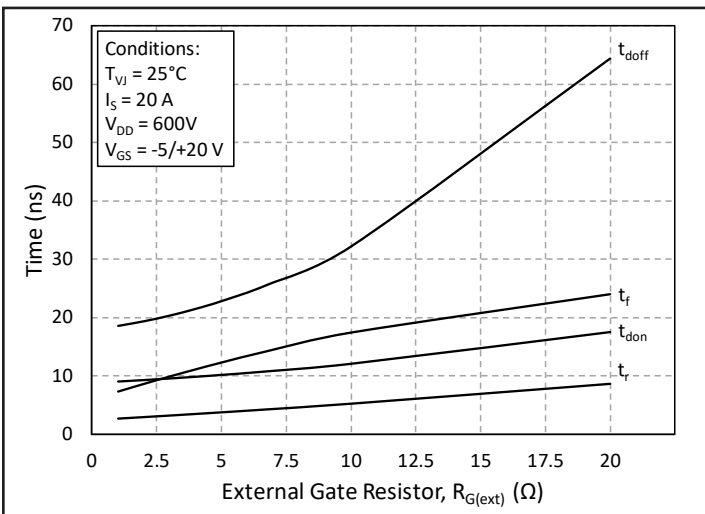

Figure 28. Timing vs. External Gate Resistance

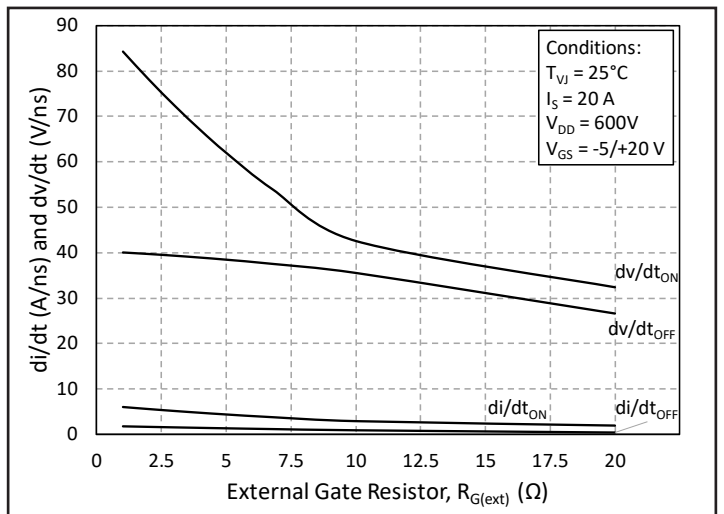

Figure 29. dv/dt and di/dt vs. External Gate Resistance



Definitions

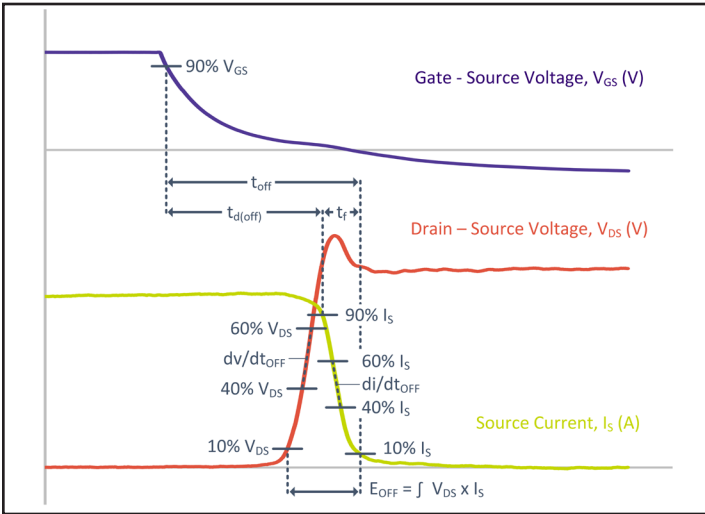

Figure 30. Turn-off Transient Definitions

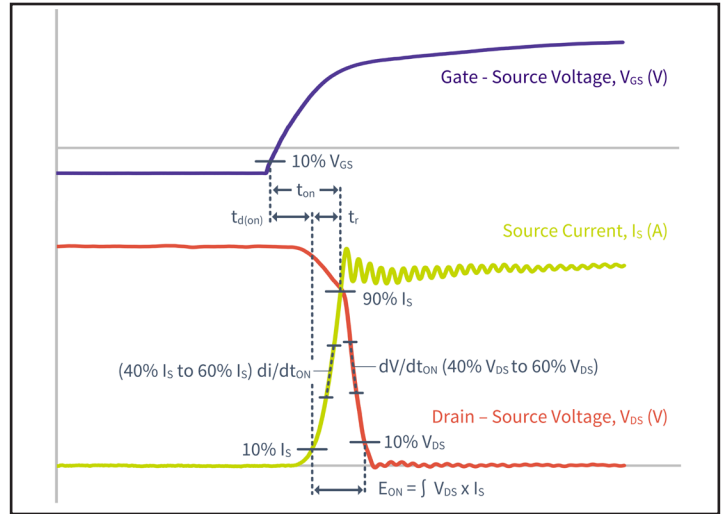

Figure 31. Turn-on Transient Definitions

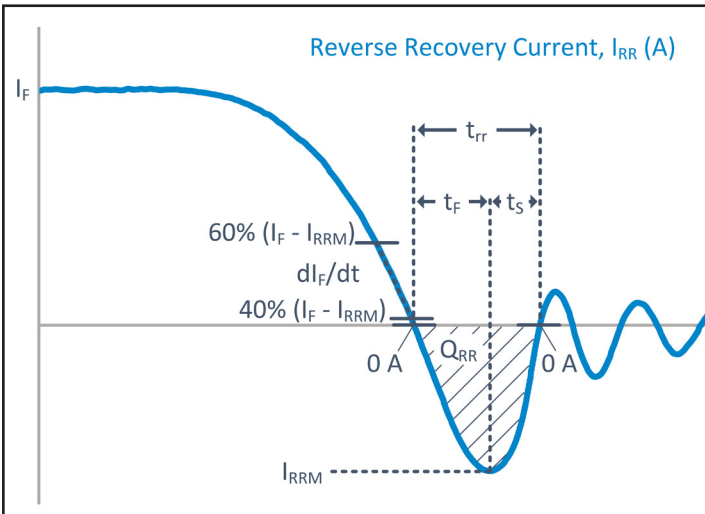

Figure 32. Reverse Recovery Definitions (Note 1)

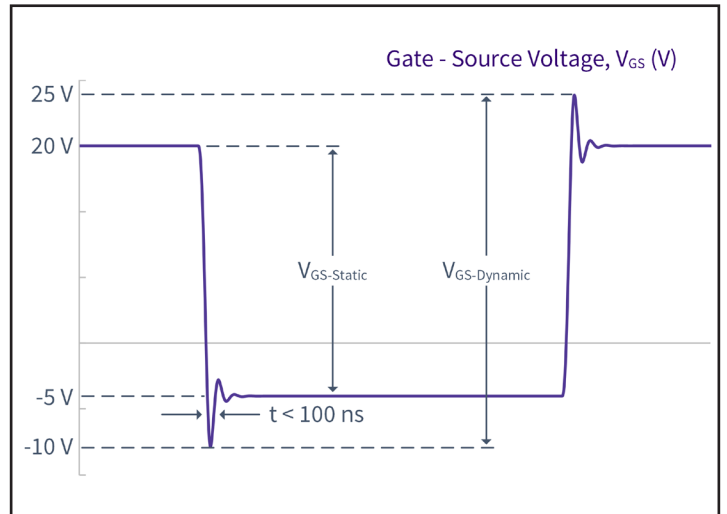
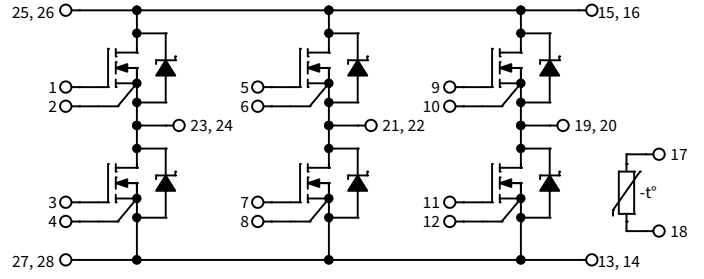
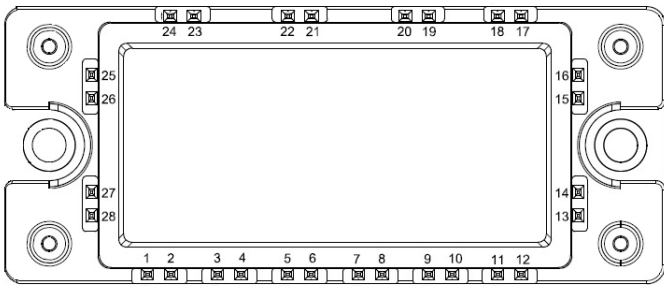

Figure 33. V_{GS} Transient Definitions



Schematic and Pin Out



Package Dimensions (mm)

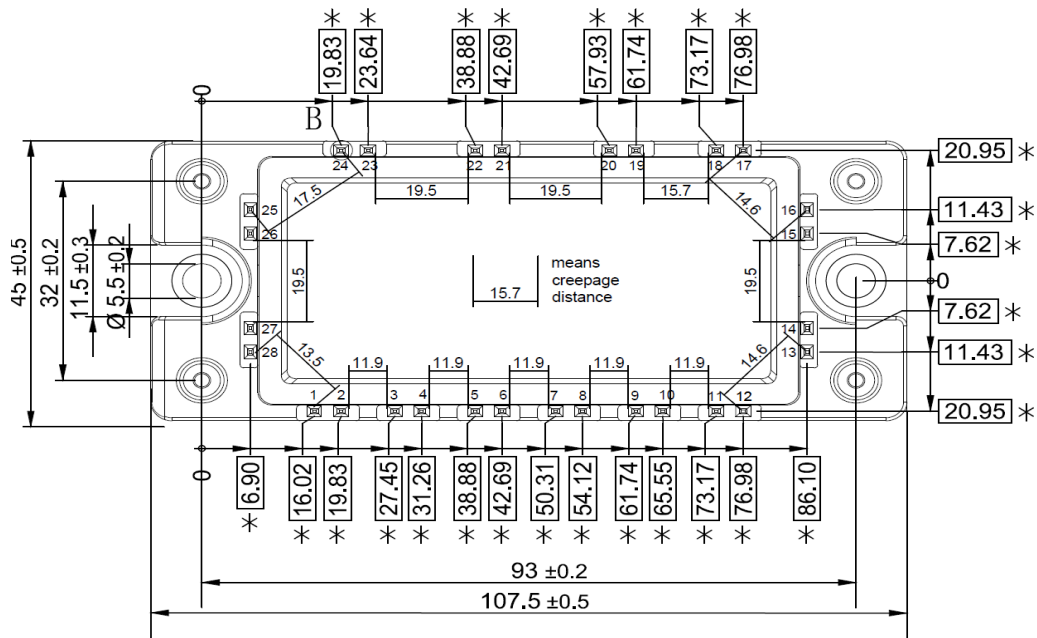
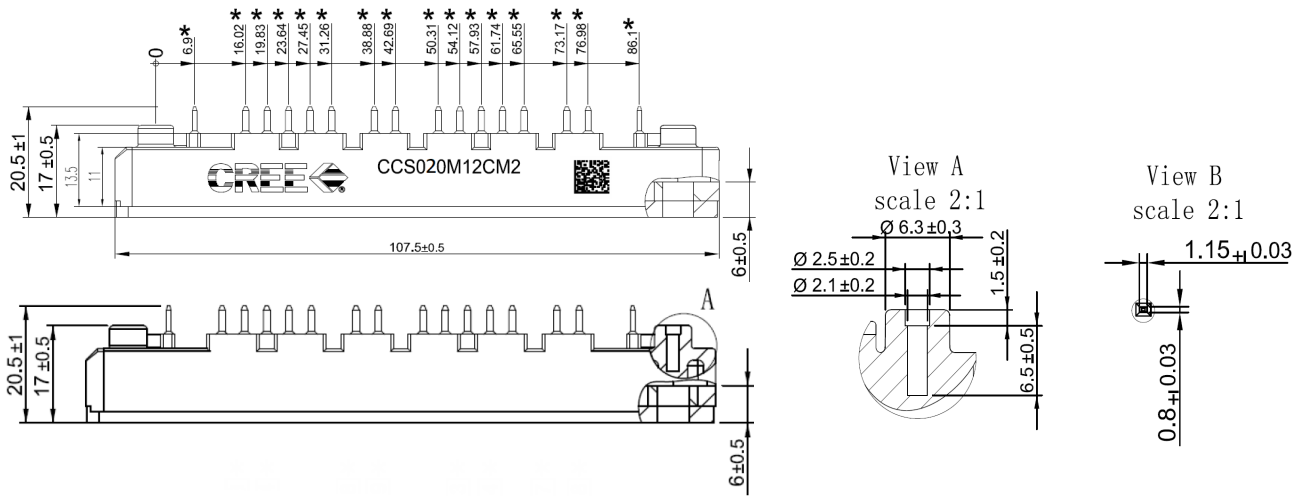

*=all dimensions with tolerance of ± 0.4

Recommendations for PCB Mounting Stand-offs

In order to mount the PCB onto the module, it is recommended to use four PCB mounting stand-offs by using self-tapping screws. Following is the recommended self-tapping screw with its torque requirements:

> Ejot DELTA PT WN 5451 K25x8 : Mmax = 0.4Nm ± 10%

Installation of self-tapping screws can be done both by hand or by using an electric screw driver. For an electric screw driver the recommended maximum speed is 300 RPM.

(Note: Do not use pneumatic screw driver to install self-tapping screws).

The recommended effective length of screw threads entering the PCB mounting stand-offs should be in between 4mm to 6.5mm range.

(Note: Self-tapping screws must be inserted straight into the PCB mounting stand-offs)

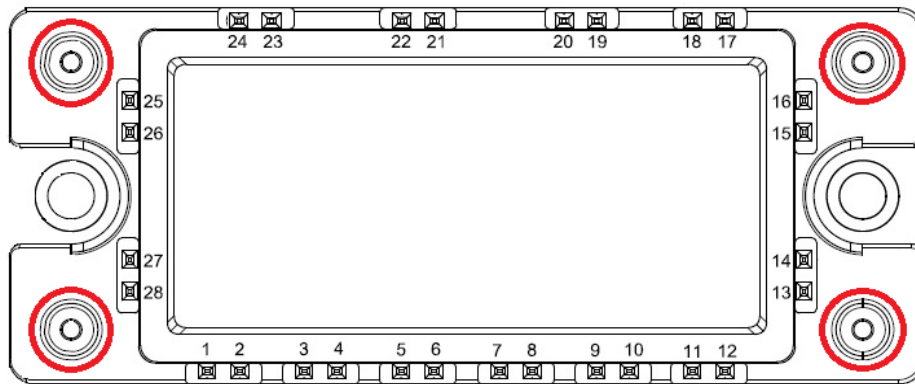

PCB Mounting Stand-offs (Marked Red)



Notes

- This product has not been designed or tested for use in, and is not intended for use in, applications implanted into the human body nor in applications in which failure of the product could lead to death, personal injury or property damage, including but not limited to equipment used in the operation of nuclear facilities, life-support machines, cardiac defibrillators or similar emergency medical equipment, aircraft navigation or communication or control systems, or air traffic control systems.
- The SiC MOSFET module switches at speeds beyond what is customarily associated with IGBT-based modules. Therefore, special precautions are required to realize optimal performance. The interconnection between the gate driver and module housing needs to be as short as possible. This will afford optimal switching time and avoid the potential for device oscillation. Also, great care is required to insure minimum inductance between the module and DC link capacitors to avoid excessive VDS overshoot.