

Shielded Power Inductor XAL1513-153

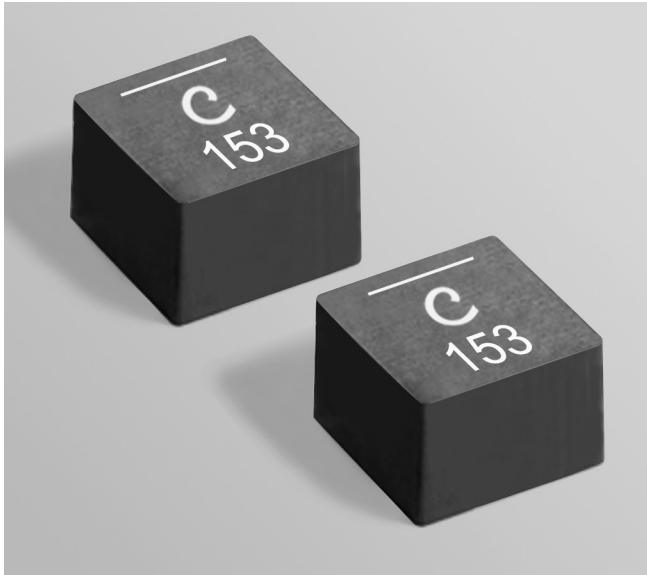

- High current; very low DCR
- AEC-Q200 Grade 1 (–40°C to +125°C)
- Soft saturation makes them ideal for VRM/VRD applications.

Core material Composite

Core and winding loss [Go to online calculator](#)

Environmental RoHS compliant, halogen free

Terminations RoHS compliant tin-silver over copper. Other terminations available at additional cost.

Weight 18.7 g

Operating voltage: 0 – 60 V

Ambient temperature –40°C to +125°C with (40°C rise) Irms current.

Maximum part temperature +165°C (ambient + temp rise). [Derating.](#)

Storage temperature Component: –55°C to +165°C.

Tape and reel packaging: –55°C to +80°C

Resistance to soldering heat Max three 40 second reflows at +260°C, parts cooled to room temperature between cycles

Moisture Sensitivity Level (MSL) 1 (unlimited floor life at <30°C / 85% relative humidity)

Packaging 100/13" reel Plastic tape: 32 mm wide, 0.35 mm thick, 24 mm pocket spacing, 13.26 mm pocket depth.

PCB washing Tested to MIL-STD-202 Method 215 plus an additional aqueous wash. See [Doc787_PCB_Washing.pdf](#).

Part number ¹	Inductance ² ±20% (µH)	DCR (mOhms) ³		SRF typ ⁴ (MHz)	Isat ⁵ (A)	Irms (A) ⁶	
		typ	max			20°C rise	40°C rise
XAL1513-153ME_	15	6.8	7.5	8.0	25.5	16	22

1. When ordering, please specify **packaging** code:

XAL1513-153MED

Packaging: D = 13" machine-ready reel. EIA-481 embossed plastic tape (100 parts per full reel). Quantities less than full reel available: in tape (not machine ready) or with leader and trailer (\$25 charge).

B = Less than full reel. In an effort to simplify our part numbering system, Coilcraft is eliminating the need for multiple packaging codes. When ordering, simply change the last letter of your part number from B to D.

2. Inductance tested at 1 MHz, 0.1 Vrms, 0 Adc.

3. DCR measured on a micro-ohmmeter.

4. SRF measured using Agilent/HP 4395A or equivalent.

5. DC current at 25°C that causes an inductance drop of 30% (typ) from its value without current.

[Click for temperature derating information.](#)

6. Current that causes the specified temperature rise from 25°C ambient.

This information is for reference only and does not represent absolute maximum ratings. [Click for temperature derating information.](#)

7. Electrical specifications at 25°C.

Refer to Doc 362 "Soldering Surface Mount Components" before soldering.

Irms Testing

Irms testing was performed on 0.75 inch wide × 0.25 inch thick copper traces in still air.

Temperature rise is highly dependent on many factors including pcb land pattern, trace size, and proximity to other components. Therefore temperature rise should be verified in application conditions.



www.coilcraft.com

US +1-847-639-6400 sales@coilcraft.com

UK +44-1236-730595 sales@coilcraft-europe.com

Taiwan +886-2-2264 3646 sales@coilcraft.com.tw

China +86-21-6218 8074 sales@coilcraft.com.cn

Singapore + 65-6484 8412 sales@coilcraft.com.sg

Document 1027-1 Revised 06/22/21

© Coilcraft Inc. 2021

This product may not be used in medical or high risk applications without prior Coilcraft approval. Specification subject to change without notice. Please check web site for latest information.



Shielded Power Inductor – XAL1513-153

L vs Current

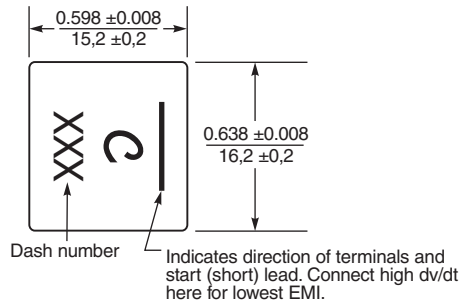
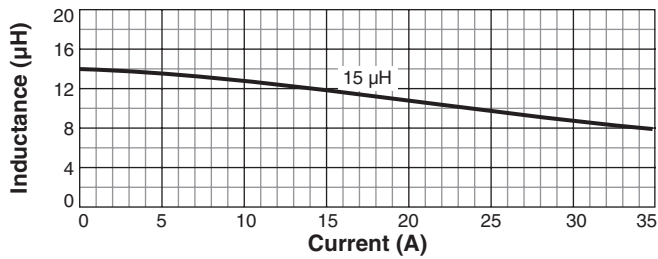

L vs Frequency

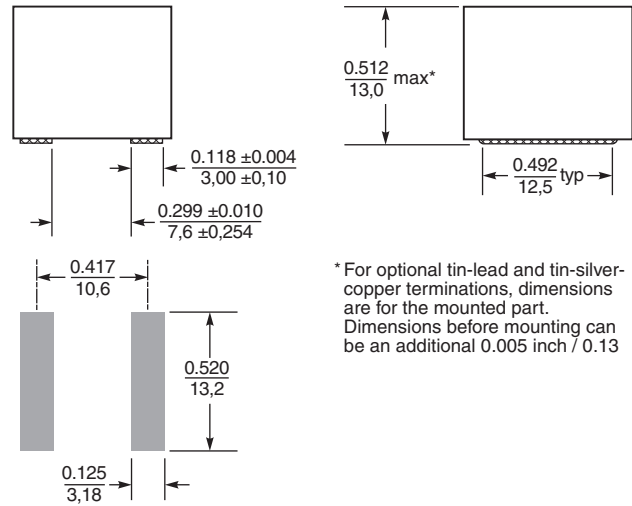
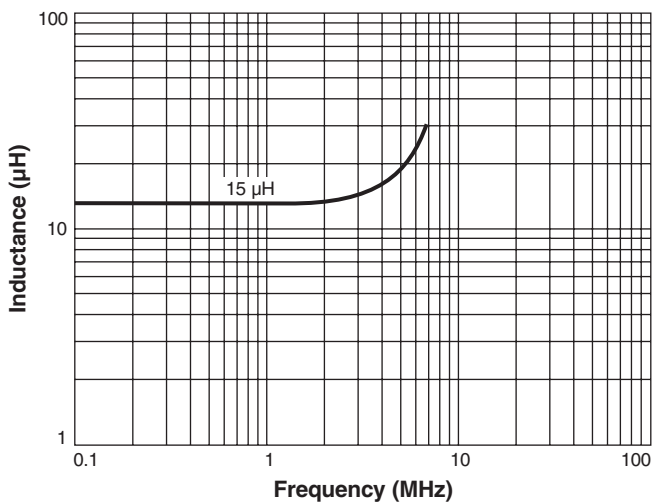

Recommended Land Pattern

Dimensions are in $\frac{\text{inches}}{\text{mm}}$