

# PTS810 Series Microminiature SMT Top Actuated

## Features/Benefits

- 4.2 x 3.2 mm footprint
- 2.5 mm thickness
- High number of cycles
- Color coded actuators

## Typical Applications

- Control panels
- Nomad devices
- Remote controls



## Specifications

FUNCTION: momentary action  
 CONTACT ARRANGEMENT: 1 make contact = SPST N.O.  
 TERMINALS: J type for SMT  
 TRAVEL: 160 & 260 gf: 0.15mm ± 0.1mm  
 400 & 600 gf: 0.20mm ± 0.1mm

	Operating Force (gf)	Operating Life (operations)
PTS810 SJM 250 SMTR LFS	160 ± 50	150,000
PTS810 SJK 250 SMTR LFS	260 ± 70	50,000
PTS810 SJG 250 SMTR LFS	400 ± 100	100,000
PTS810 SJS 250 SMTR LFS	600 ± 150	150,000

## Packaging

Switches in reels of 2,900 pieces.  
 Dimensions of reels according to EIA 481B  
 External diameter 330 mm

## Electrical

MAXIMUM VOLTAGE: 16 VDC  
 MAXIMUM CURRENT DC: 50 mA  
 DIELECTRIC STRENGTH: 250 VA C (1mn)  
 CONTACT RESISTANCE: ≤ 500 mΩ  
 INSULATION RESISTANCE: ≥ 100 MΩ  
 BOUNCE TIME: ≤ 10 ms

## Environmental

OPERATING TEMPERATURE: -40°C to 85°C

## Process

SOLDERING: This component is suited to the following methods:  
 Infrared Reflow Soldering in accordance with IEC61760-1

### NOTE:

- Specifications listed above are for switches with standard options. For information on specific and custom switches, consult Customer Service Center.
- The PTS series is not certified for using in Automotive application and no PPAP. However, in the case of some automotive accessories and specific applications for 2 and 3 wheeled vehicles the PTS is widely used and very suitable. Please contact your local C&K representative to discuss your application and the best switch solution.

## How To Order

Our easy build-a-switch concept allows you to mix and match options to create the switch you need. To order, select desired option from each category and place it in the appropriate box.

For any part number different from those listed above, please consult your local representative.

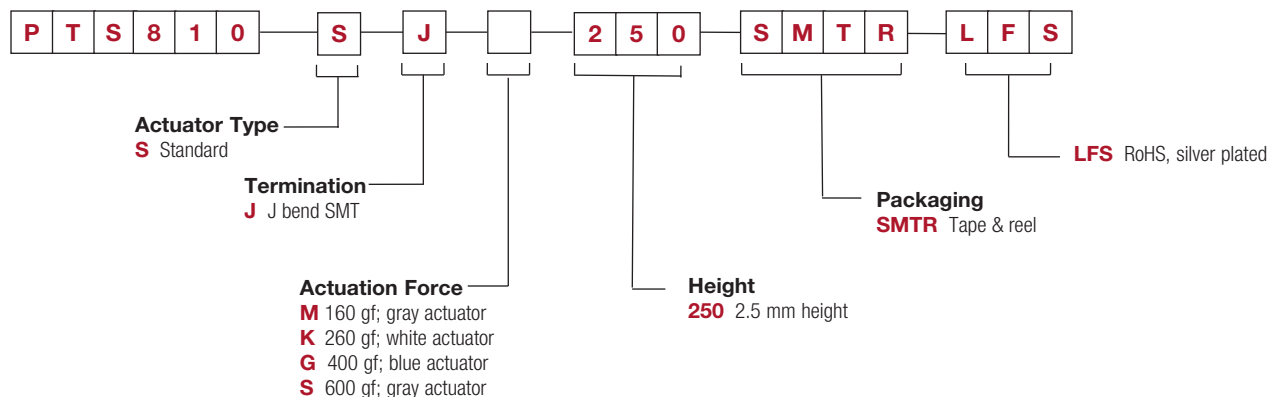

# PTS810 Series Microminiature SMT Top Actuated

PTS810

Tactile Switches

B

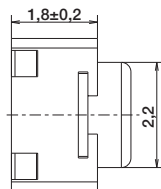
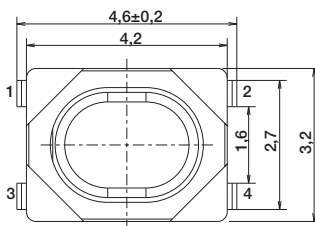
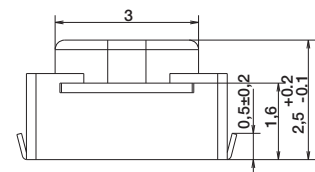

SCHEMATIC

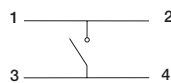

RECOMMENDED PCB LAYOUT

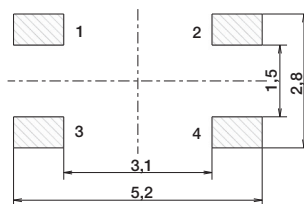

## TAPE & REEL

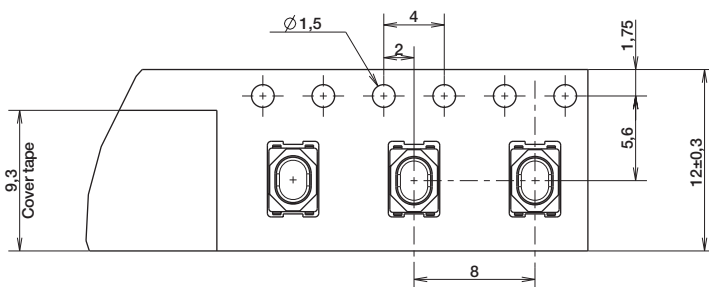

CARRIER TAPE

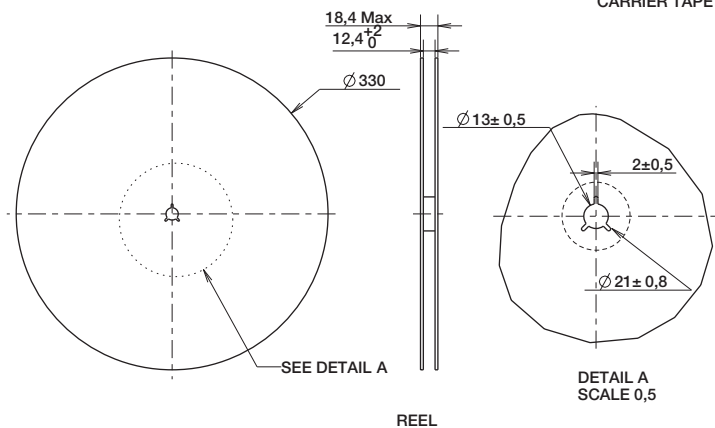

DETAIL A  
SCALE 0,5

REEL