

DA Series Miniature Single Pole Rocker Switches

Features/Benefits

- Nice actuator styling with multiple options
- Guards to prevent accidental actuation
- Momentary and maintained functions
- IP65 splash proof rubber boot option
- RoHS compliant

Typical Applications

- Small appliances
- Computers and peripherals
- Medical instrumentation



UL **UL 61058-1**

Specifications

CONTACT RATING:
 16 AMPS @ 125 VAC, 1/3 HP;
 10 AMPS @ 250 VAC, 1/2 HP.
 10 AMPS @ 125 VAC, 6 AMPS @ 250 VAC.
 ELECTRICAL LIFE: 10,000 make and break cycles at full load.
 INSULATION RESISTANCE: 10⁸ Ω min.
 DIELECTRIC STRENGTH: 1,500 VRMS @ sea level.
 OPERATING TEMPERATURE: -20°C to +85°C

Materials

HOUSING AND ACTUATOR: 6/6 nylon (UL94V-2), black, matte finish.
 ILLUMINATED ACTUATOR: Polycarbonate, matte finish.
 CENTER CONTACTS: Silver plated, copper alloy.
 END CONTACTS: Silver plated.
 ALL TERMINALS: Silver plated, copper alloy.

NOTE: Specifications and materials listed above are for switches with standard options. For information on specific and custom switches, consult Customer Service Center.

Build-A-Switch

To order, simply select desired option from each category and place in the appropriate box. Available options are shown and described on pages G-57 through G-59. For additional options not shown in catalog, consult Customer Service Center.

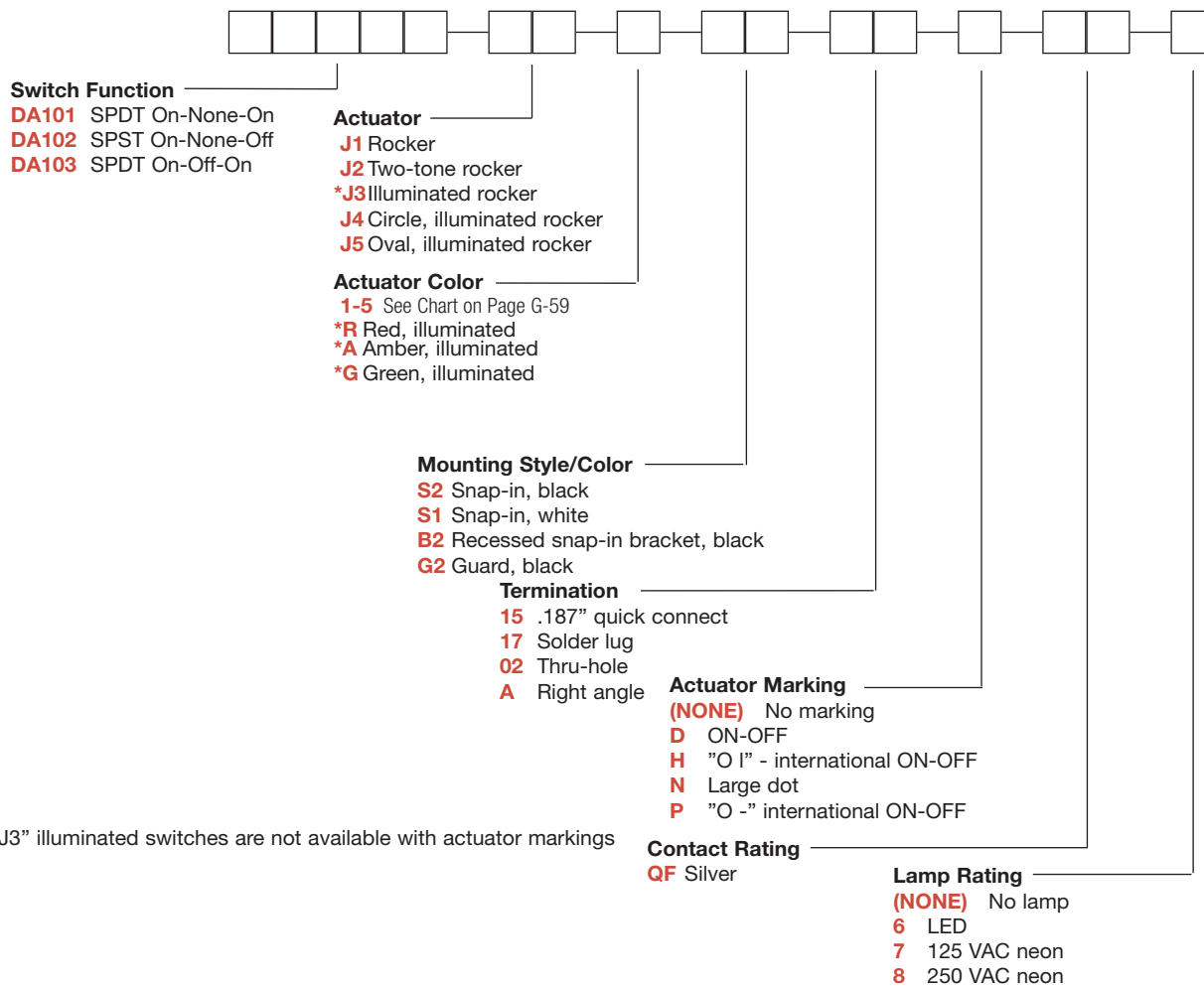

* "J3" illuminated switches are not available with actuator markings

Rocker

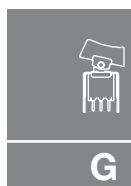

C&K

Dimensions are shown: Inches (mm)
 Specifications and dimensions subject to change

DA Series Miniature Single Pole Rocker Switches

SWITCH FUNCTION

NO. POLES	MODEL NO.	SWITCH FUNCTION			CONNECTED TERMINALS			SCHEMATIC
SP	DA101	ON	NONE	ON	2-3	N/A	2-1	
	DA102	ON	NONE	OFF				 OR For 7 & 8 Illuminated Versions Only
	DA103	ON	OFF	ON				 For 6 Illuminated Versions Only

Shown in Pos. 1

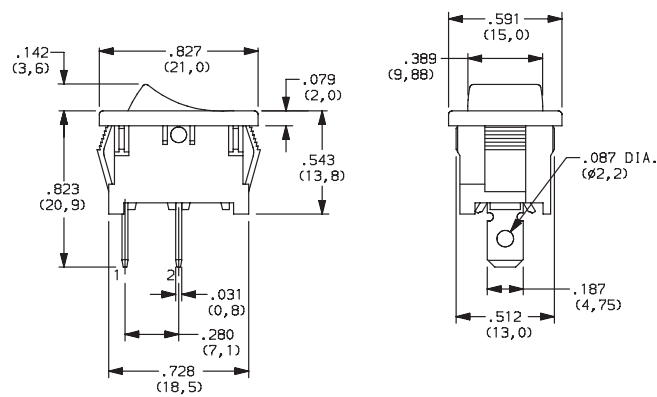

ACTUATOR

- J1** ROCKER
- *J3** ILLUMINATED ROCKER

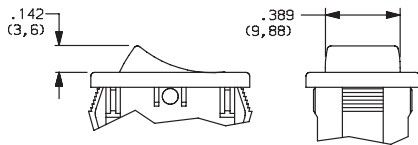

NOTE: J3 actuator available with DA102 switch functions, 7&8 lamp ratings and not available with O2 and A termination options.

* J3 actuator not available with markings

- J2** TWO-TONE ROCKER

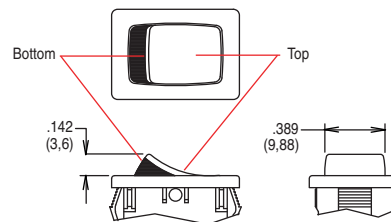

NOTE:

1. Available with DA102 switch function only.
2. Available with None or P actuator marking options only.



Dimensions are shown: Inches (mm)
Specifications and dimensions subject to change



DA Series Miniature Single Pole Rocker Switches

ACTUATOR

J4 CIRCLE, ILLUMINATED ROCKER

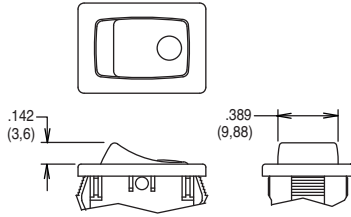

NOTE: Available with DA102 switch function and 7 & 8 lamp ratings combinations only. Not available with O2 and A termination options.

J5 OVAL, ILLUMINATED ROCKER

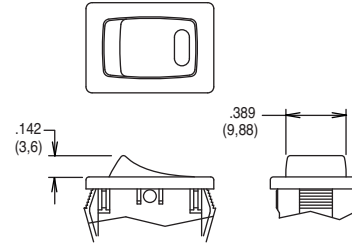

NOTE: Available with DA102 switch function and 6 lamp rating combinations only. Not available with O2 and A termination options.

ACTUATOR COLOR

Option Code	ACTUATOR COLOR	
	TOP	BOTTOM
2	BLACK	
1	WHITE	
3	RED	
R	RED, ILLUMINATED	
A	AMBER, ILLUMINATED	
G	GREEN, ILLUMINATED	

Option Code	ACTUATOR COLOR	
	TOP	BOTTOM
1	WHITE	RED
2	WHITE	BLACK
3	RED	WHITE
4	BLACK	WHITE
5	BLACK	RED

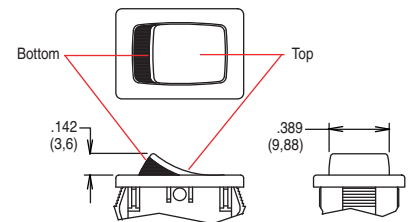

MOUNTING STYLE/COLOR

S2 SNAP-IN, BLACK

S1 SNAP-IN, WHITE

G2 GUARD, BLACK

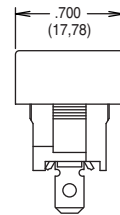
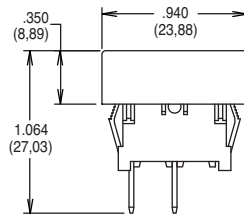
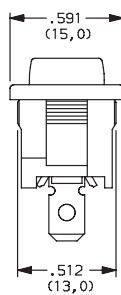
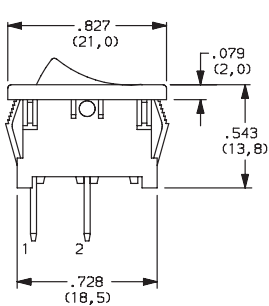

S2, S1 & G2 PANEL MOUNTING

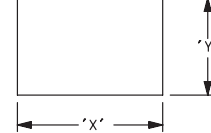

PANEL THICKNESS	"X"	"Y"
0.030-0.049 (0,75-1,25)	0.756-.004 (19,2-0,1)	0.512+.004 (13,0+0,1)
0.049-0.079 (1,25-2,0)	0.764-.004 (19,4-0,1)	0.512+.004 (13,0+0,1)
0.079-0.118 (2,0-3,0)	0.779-.004 (19,8-0,1)	0.512+.004 (13,0+0,1)

NOTE: Available with DA10X switch functions only.

Actuator shown in Pos. 1

B2 RECESSED SNAP-IN BRACKET, BLACK

B2 PANEL MOUNTING

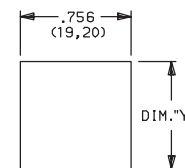
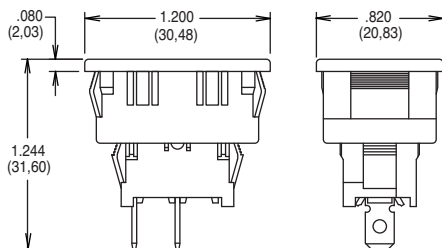

PANEL THICKNESS	"Y"
0.030-0.049 (0,75-0,25)	1.068 (27,13)
0.049-0.079 (1,25-2,0)	1.076 (27,33)
0.079-0.118 (2,0-3,0)	1.092 (27,74)

NOTE: Available with DA10X switch functions only.

Rocker



G

C&K



Third Angle Projection

Dimensions are shown: Inches (mm)
Specifications and dimensions subject to change

DA Series Miniature Single Pole Rocker Switches

TERMINATION

15 .187" QUICK CONNECT

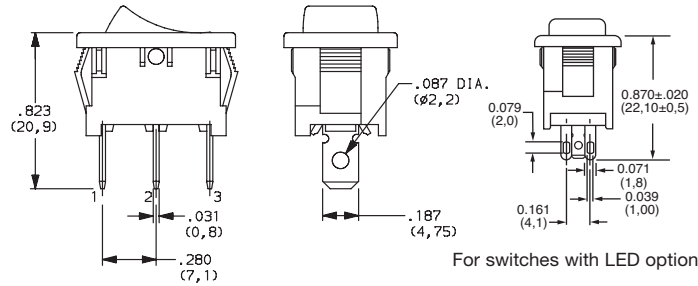

17 SOLDER LUG

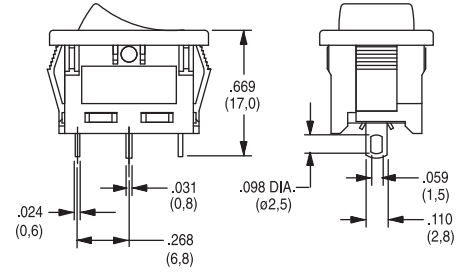

02* THRU-HOLE

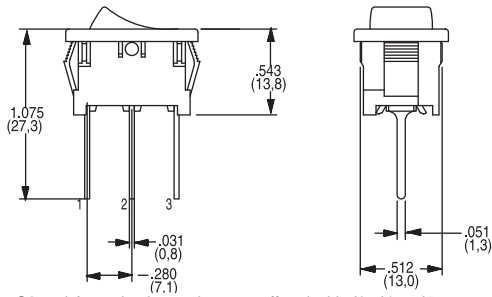

A* RIGHT ANGLE

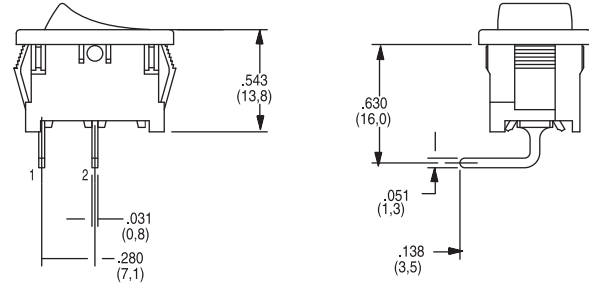

* NOTE - O2 and A termination options not offered with J3, J4 or J5 actuator options.

ACTUATOR MARKING

NONE NO MARKING

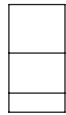

D ON-OFF



H O I



N LARGE DOT



P O -

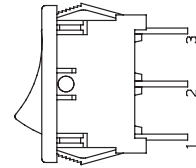

All models shown in Pos. 1
Markings not available with J3 actuator

NOTE: Orientation of actuator marking and terminals.

CONTACT MATERIAL

OPTION CODE	CONTACT AND TERMINAL MATERIAL	RATINGS	
QF	SILVER	POWER	16 AMPS @ 125 VAC; 1/3 HP; 10 AMPS @ 250 VAC; 1/2 10 AMPS @ 125 VAC, 6 AMPS @ 250 VAC

* Note: See Technical Data section of this catalog for RoHS compliant and compatible definitions and specifications.

LAMP RATING

(NONE) NO LAMP

6 LED RATING @ 10 mA $V_f=1.85V$

7 125 VAC 33kΩ NEON

8 250 VAC 150kΩ NEON

ACCESSORIES

216C0000 IP65 SPLASH PROOF RUBBER BOOT

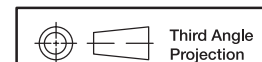
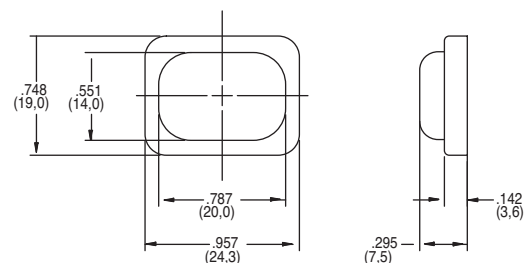

Third Angle Projection
Dimensions are shown: Inches (mm)
Specifications and dimensions subject to change

C&K

