

# DS Series Interlock Pushbutton Switches

## Features/Benefits

- Snap-in mounting
- Reliable snap action mechanism
- Latch or momentary
- RoHS compliant
- Halogen free material

## Typical Applications

- Interlock switch
- Detection switch
- Circuit interrupt



  **UL61058-1**

## Specifications

FUNCTION: Single pole double throw / Double pole double throw  
MOUNTING TYPE: Snap in style

## Electrical

ELECTRICAL LIFE: see ratings chart below  
DIELECTRIC STRENGTH: 1500 V (50-60 Hz @ sea level)  
INSULATION RESISTANCE: 100 M  $\Omega$  min.  
INITIAL CONTACT RESISTANCE: 30 milli-ohms

## Materials

HOUSING, COVER, ACTUATOR, KNOB: PA 66/6 halogen free, UL94V-0  
NO & NC FIXED TERMINALS: Copper alloy  
COMMON TERMINALS: Copper alloy, silver plate  
CONTACTS: Silver alloy / F5 rating gold plated over silver alloy  
RETURN SPRINGS: Stainless steel

## Operating Environment

OPERATING TEMPERATURE: -40°C to +85°C

**NOTE:** Specifications and materials listed above are for switches with standard options.  
For information on specific and custom switches, please contact Customer Service.

## Build-A-Switch

To order, simply select desired option from each category and place in the appropriate box.

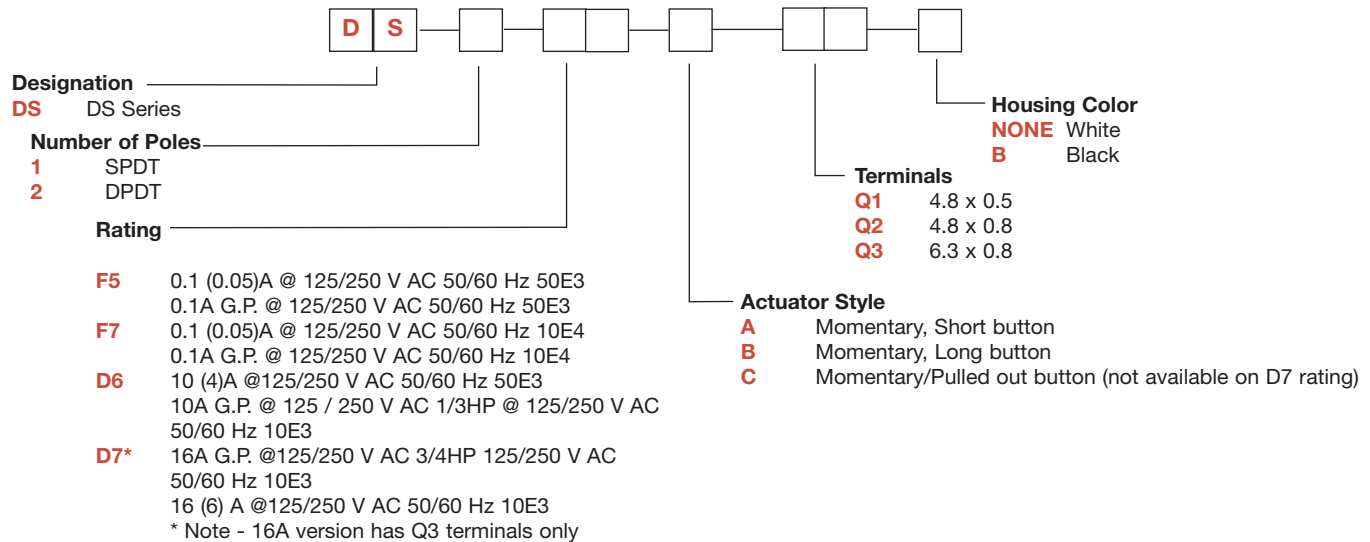

## International Rating Symbols

10E3	Cycles 10,000
10E4	Cycles 100,000
50E3	Cycles 50,000
10(4)	Current rating: First number represents resistive rating. Second number represents inductive (motor) rating
GP	General purpose rating UL1054



Snap-acting

# DS Series Interlock Pushbutton Switches

## NUMBER OF POLES

### 1 SPDT

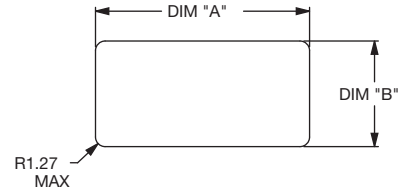
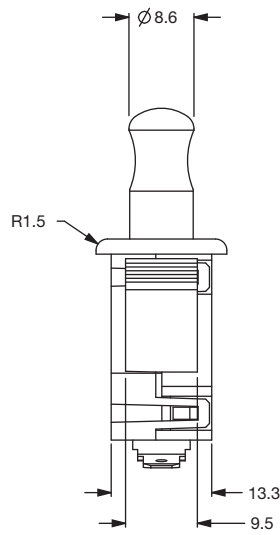
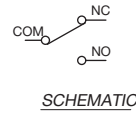
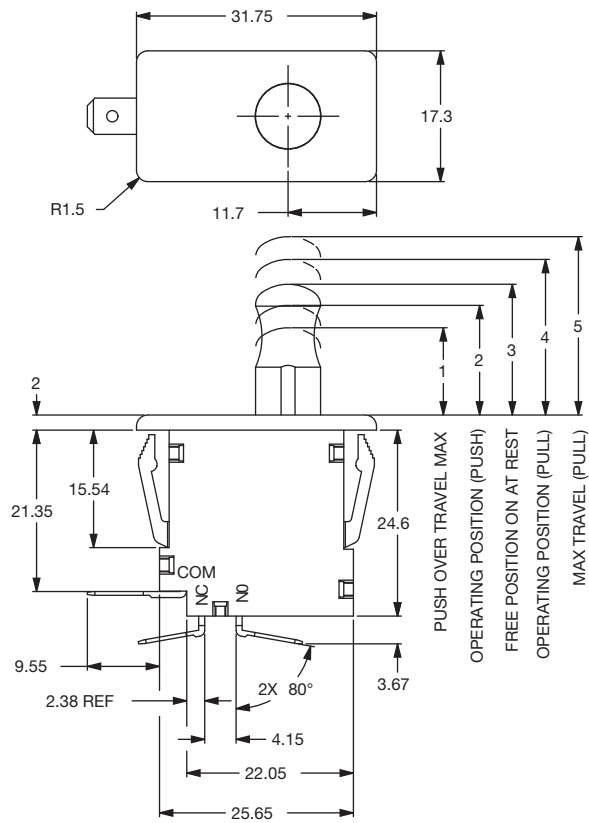

PANEL MOUNTING		
PANEL THICKNESS	DIM "A" mm	DIM "B" mm
1.14	28.32	13.97
2.54	28.58	13.97

**Snap-acting**

### 2 DPDT

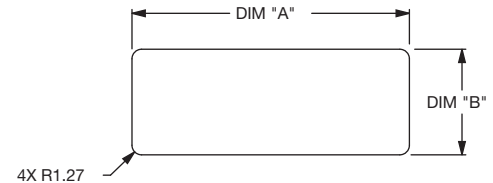
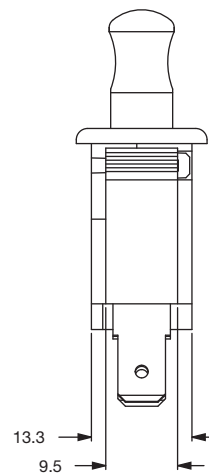
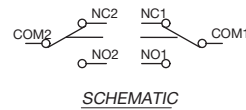
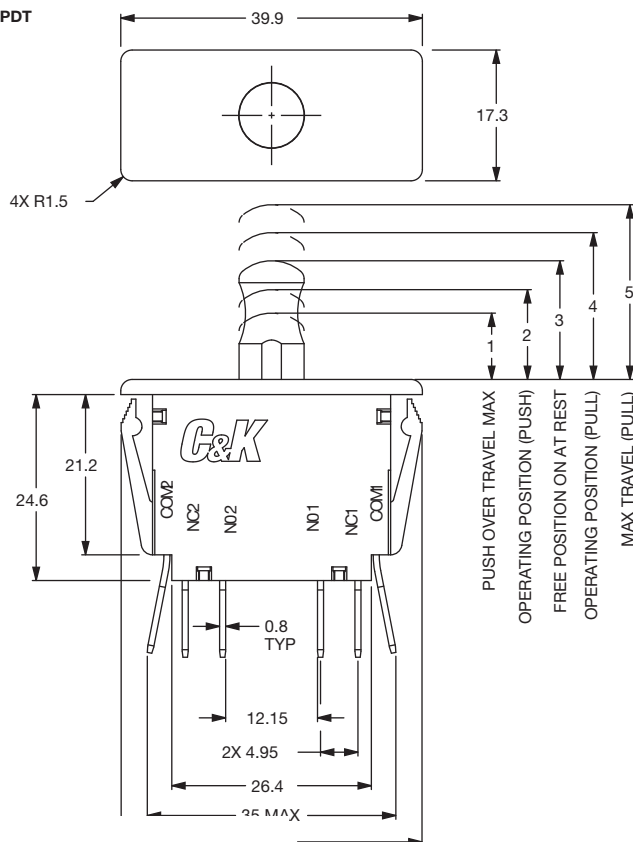

PANEL MOUNTING		
PANEL THICKNESS	DIM "A" mm	DIM "B" mm
1.14	36.70	13.97
2.54	36.96	13.97



Dimensions are shown: mm  
Specifications and dimensions subject to change

# DS Series Interlock Pushbutton Switches

## ACTUATOR STYLE / SPECIFICATIONS

**A** SHORT BUTTON

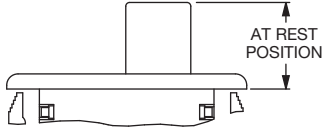

SHORT BUTTON

**B** LONG BUTTON

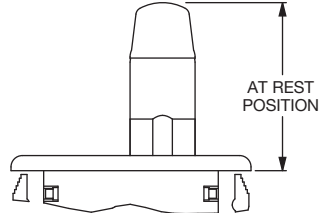

LONG BUTTON

**C** MOMENTARY/PULLED OUT

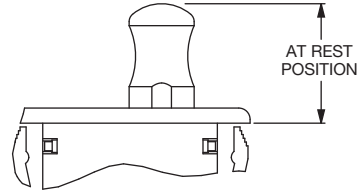

FREE POSITION

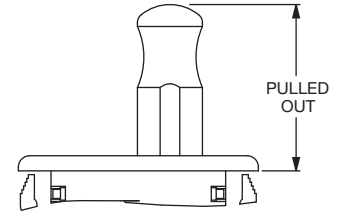

PULLED OUT POSITION

### SPDT Specification

BUTTON STYLE	OVER TRAVEL POSITION PUSH MAX	OVER TRAVEL POSITION PULL MAX	OPERATING POSITION PUSH	OPERATING POSITION PULL	FREE POSITION AT REST	OPERATING FORCE	
A	3.20	NA	8.90 ± 1.25	NA	11.45 ± 0.75	425 gf	
B	10.15	NA	19.55 ± 1.25	NA	22.25 ± 0.75	425 gf	
C	13.20	24.90	16.75 ± 1.25	21.60 ± 1.25	19.30 ± 0.75	PUSH 385gf	PULL 475gf

### DPDT Specification

BUTTON STYLE	OVER TRAVEL POSITION PUSH MAX	OVER TRAVEL POSITION PULL MAX	OPERATING POSITION PUSH	OPERATING POSITION PULL	FREE POSITION AT REST	OPERATING FORCE	
A	3.20	NA	8.90 ± 1.25	NA	11.45 ± 0.75	680 gf	
B	10.15	NA	19.55 ± 1.25	NA	22.25 ± 0.75	680gf	
C	13.20	24.90	16.75 ± 1.25	21.60 ± 1.25	19.30 ± 0.75	PUSH 560gf	PULL 750gf

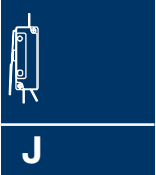

Snap-acting

## TERMINALS

**Q1** 4.8 x 0.5  
**Q2** 4.8 x 0.8

**Q3** 6.3 x 0.8

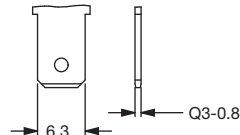
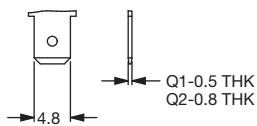

**C&K**



Third Angle  
Projection

Dimensions are shown: mm  
Specifications and dimensions subject to change