

Type SM Motor-Run and Power Supply Capacitors



Metallized Polypropylene

Applications

Motor Run Capacitors — provide starting torque and power factor correction for split phase motors typically used in refrigeration and air conditioning.

Power Supply Capacitors — are used in power supply circuits to provide noise suppression, voltage regulation, and line current reduction.

Highlights

- Voltage range: 240 to 660 Vac
- Capacitance range: .5 to 120 μ F
- Temperature range: -40°C to 70°C, 90°C avail.
- Capacitance tolerance: $\pm 10\%$ standard tolerance; $\pm 3\%$ available.
- Self healing
- Fault Current Protection up to 10,000 amps AFC
- Low energy consumption. Dissipation factor <0.1%
- 2-tine, 1/4" quick connect lug terminals are standard (4 bladed available)
- Meet requirements of EIA 456A
- UL recognized file No. E56959
- CSA certified file No. LR075387/LR700632

High-Voltage and Motor Capacitors

Service Life Objective

The service life objective for this series is 60,000 hours of operating life with a 94% survival rate when operated at full voltage, 60 Hz, and rated ambient temperature. AC capacitors are frequently used at voltages and ambient temperatures other than rated conditions. Service life may be estimated under specific conditions of temperature and voltage by using the curves as shown to the right.

Capacitance vs. Temperature

The *Capacitance vs. Temperature* curve may be used to determine the capacitance change as a function of temperature. Capacitance varies by no more than $\pm 3\%$ over the operating temperature range.

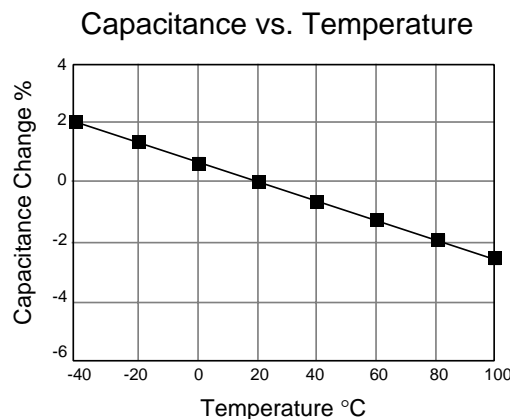
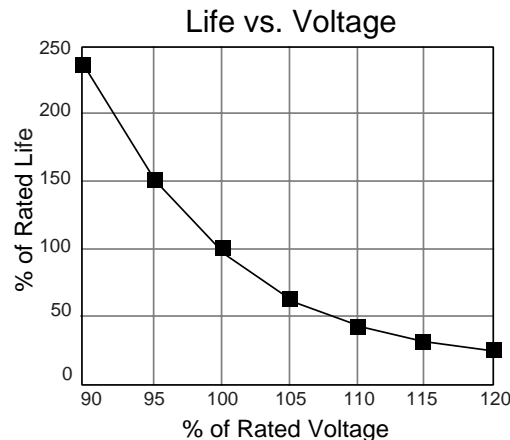
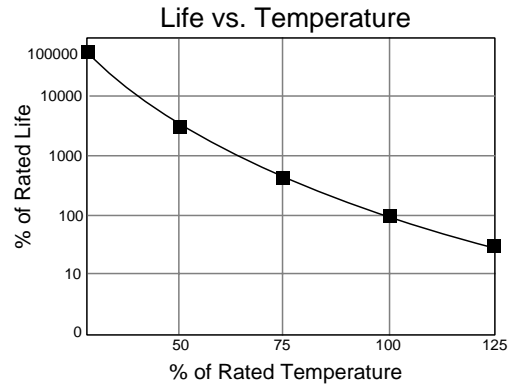

Type SM Motor-Run and Power Supply Capacitors

Type SM – Oval Case Style

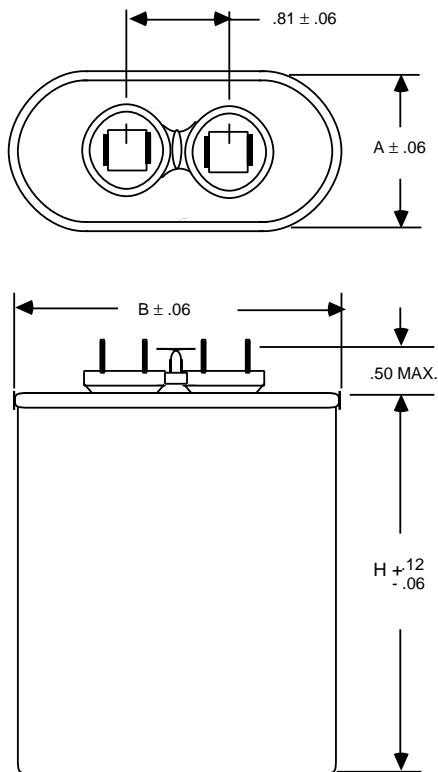

Case Code

Case Code	Dimensions (Inches)		
	A	B	H
KK	1.31	2.16	see table
KT	1.91	2.91	see table
KB	1.97	3.66	see table

Cap. (μF)	Stock Items	Catalog Number	Case Code	H (inches)
240 Vac 70 °C Case Temperature				
4.0		KKSM24U405M23	KK	2.19
5.0		KKSM24U505M23	KK	2.19
6.0		KKSM24U605M23	KK	2.19
7.5		KKSM24U755M23	KK	2.19
10.0		KKSM24U106M23	KK	2.19
15.0		KKSM24U156M2B	KK	2.69
20.0		KKSM24U206M32	KK	3.13
25.0		KTSM24U256M2B	KT	2.69
30.0		KTSM24U306M2B	KT	2.69
35.0		KTSM24U356M2B	KT	2.69
40.0		KTSM24U406M32	KT	3.13
45.0		KTSM24U456M32	KT	3.13
50.0		KTSM24U506M32	KT	3.13
60.0		KTSM24U606M3E	KT	3.88
70.0		KTSM24U706M3E	KT	3.88

Cap. (μF)	Stock Items	Catalog Number	Case Code	H (inches)
370 Vac 70 °C Case Temperature				
2.0	S	KKSM37U205M18	KK	1.50
2.0	S	KKSM37U205M23	KK	2.19
3.0	S	KKSM37U305M18	KK	1.50
3.0	S	KKSM37U305M23	KK	2.19
4.0	S	KKSM37U405M18	KK	1.50
4.0	S	KKSM37U405M23	KK	2.19
5.0	S	KKSM37U505M18	KK	1.50
5.0	S	KKSM37U505M23	KK	2.19
6.0	S	KKSM37U605M18	KK	1.50
6.0	S	KKSM37U605M23	KK	2.19
7.5	S	KKSM37U755M23	KK	2.19
10.0	S	KKSM37U106M2B	KK	2.69
12.5	S	KKSM37U1255M32	KK	3.13
15.0	S	KKSM37U156M3E	KK	3.88
17.5	S	KTSM37U1755M2B	KT	2.69
20.0		KKSM37U206M3E	KK	3.88
20.0	S	KTSM37U206M2B	KT	2.69
25.0	S	KTSM37U256M2B	KT	2.69
30.0	S	KTSM37U306M32	KT	3.13
35.0	S	KTSM37U356M32	KT	3.13
40.0	S	KTSM37U406M3E	KT	3.88
45.0	S	KTSM37U456M3E	KT	3.88
45.0		KBSM37U456M3E	KB	3.88
50.0	S	KTSM37U506M3E	KT	3.88
50.0	S	KBSM37U506M3E	KB	3.88
440 Vac 70 °C Case Temperature				
2.0	S	KKSM44U205M23	KK	2.19
3.0	S	KKSM44U305M23	KK	2.19
4.0	S	KKSM44U405M23	KK	2.19
5.0	S	KKSM44U505M23	KK	2.19
6.0	S	KKSM44U605M2B	KK	2.69
7.5	S	KKSM44U755M32	KK	3.13
10.0	S	KKSM44U106M3E	KK	3.88
15.0	S	KKSM44U156M3E	KK	3.88
15.0	S	KTSM44U156M2B	KT	2.69
20.0	S	KTSM44U206M3E	KT	3.88
25.0	S	KTSM44U256M3E	KT	3.88
30.0	S	KTSM44U306M3E	KT	3.88
35.0	S	KBSM44U356M3E	KB	3.88
40.0	S	KBSM44U406M3E	KB	3.88
45.0	S	KBSM44U456M3E	KB	3.88
50.0	S	KBSM44U506M3E	KB	3.88
55.0	S	KBSM44U556M44	KB	4.25
60.0	S	KBSM44U606M44	KB	4.25

High-Voltage and Motor Capacitors

Type SM Motor-Run and Power Supply Capacitors

Cap. (μF)	Stock Items	Catalog Number	Case Code	H (inches)
480 Vac 70 °C Case Temperature				
4.0		KKSM48U405M23	KK	2.19
5.0		KKSM48U505M32	KK	3.13
6.0		KKSM48U605M32	KK	3.13
7.5		KKSM48U755M32	KK	3.13
10.0		KKSM48U106M32	KK	3.13
15.0		KTSM48U156M32	KT	3.13
20.0		KTSM48U206M3E	KT	3.88
25.0		KTSM48U256M3E	KT	3.88
30.0		KTSM48U306M3E	KT	3.88
40.0		KBSM48U406M3E	KB	3.88
660 Vac 70 °C Case Temperature				
1.0		KKSM66U105M23	KK	2.19
2.0	S	KKSM66U205M23	KK	2.19
3.0	S	KKSM66U305M23	KK	2.19
4.0	S	KKSM66U405M2B	KK	2.69
5.0	S	KKSM66U505M32	KK	3.13
6.0	S	KKSM66U605M3E	KK	3.88
8.0	S	KKSM66U805M3E	KK	3.88
8.0	S	KTSM66U805M32	KT	3.13
10.0	S	KKSM66U106M3E	KK	3.88
10.0	S	KTSM66U106M32	KT	3.13
12.0	S	KTSM66U126M32	KT	3.13
15.0	S	KTSM66U156M3E	KT	3.88
18.0	S	KTSM66U186M3E	KT	3.88
18.0	S	KBSM66U186M3E	KB	3.88
20.0	S	KBSM66U206M3E	KB	3.88
25.0	S	KBSM66U256M3E	KB	3.88
30.0	S	KBSM66U306M3E	KB	3.88
35.0		KBSM66U356M3E	KB	3.88
40.0		KBSM66U406M44	KB	4.25

Accessories for Oval Capacitors

Insulating Terminal Boots UL 465 Listed

44603

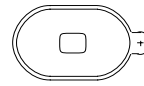

32108-2

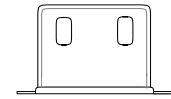
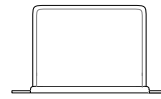
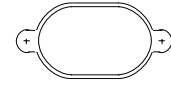

Wrap Around Bracket

Case Code	Bracket
KK	30393-5
KT	30393-9
KB	30393-10

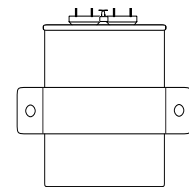

End Mount Footed Bracket (2 required)

Case Height	Bracket
2.19	30434-34
2.69	30434-42
3.13	30434-49
3.88	30434-61
4.25	30434-67

30434

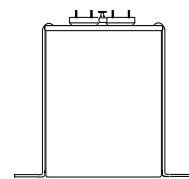
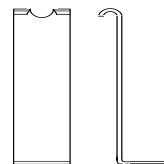

Side Mount Footed Bracket (2 required)

Case Height	Bracket
2.19	31762-45
2.69	31762-47
3.13	31762-49
3.88	31762-18
4.25	31762-52

31762

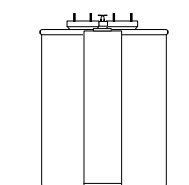
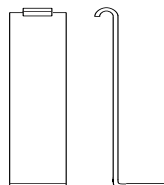

Universal Mounting Brackets 32107

Case Code	Bracket
KK	32107-1
KT	32107-2
KB	32107-3



6-32 screw and nut



6-32 screw and nut

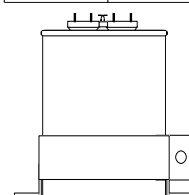

Options

- Tinplated steel cans are standard. Aluminum cases are available upon request.
- Tighter capacitance tolerances such as $\pm 3\%$ or $\pm 6\%$ are available.
- +90°C ratings are available for HID lighting and power supply applications.
- Discharge resistors are available.
- Special terminal lugs such as 4 tines per terminal or 2 tines plus 1 fork lug available.
- Dual capacitance values are available for 370 Vac and 440 Vac applications.

High-Voltage and Motor Capacitors

Type SM Motor-Run and Power Supply Capacitors

Type SM - Round Case Style

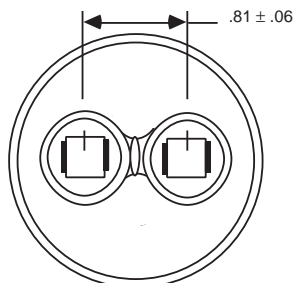

Case Code

Case Code	D (inches)	H
P	1.87	see table
S	2.12	see table
T	2.62	see table

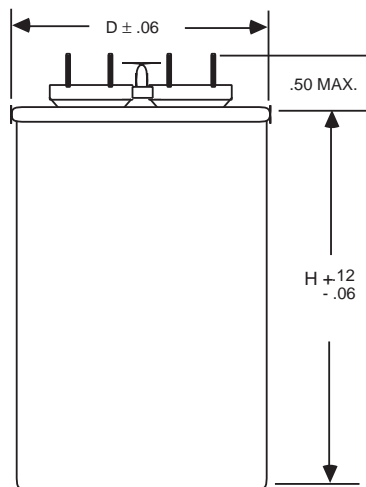

Hardware for Round Capacitors

Wrap Around Bracket

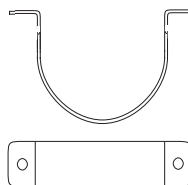

Case Code	Bracket
P	30393-23
S	30393-24
T	30393-25

3 Footed Round Mounting Bracket

Case Code	Bracket
P	32107-6A
S	32107-7A
T	32107-8A

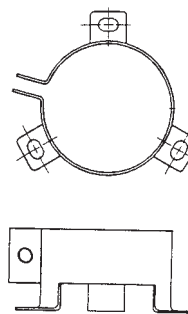

2 Footed Round Mounting Bracket

Case Code	Bracket
P	32107-6
S	32107-7
T	32107-8

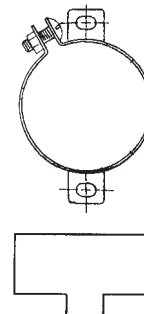

Cap. (μF)	Stock Items	Catalog Number	Case Code	H (inches)
370 Vac 70 °C Case Temperature				
2.0		SMP37U205M24	P	2.25
3.0		SMP37U305M24	P	2.25
4.0	S	SMP37U405M24	P	2.25
5.0		SMP37U505M24	P	2.25
6.0		SMP37U605M24	P	2.25
7.5		SMP37U755M24	P	2.25
10.0	S	SMP37U106M24	P	2.25
12.5	S	SMP37U1255M24	P	2.25
15.0	S	SMP37U156M2E	P	2.88
17.5		SMP37U1755M2E	P	2.88
20.0	S	SMP37U206M2E	P	2.88
25.0	S	SMP37U256M2E	P	2.88
30.0	S	SMP37U306M2E	P	2.88
35.0	S	SMS37U356M2E	S	2.88
40.0	S	SMS37U406M2E	S	2.88
45.0		SMS37U456M3C	S	3.75
50.0	S	SMS37U506M3C	S	3.75
55.0	S	SMS37U556M3C	S	3.75
60.0	S	SMT37U606M3C	T	3.75
65.0		SMT37U656M3C	T	3.75
70.0		SMT37U706M3C	T	3.75
75.0		SMT37U756M3C	T	3.75
80.0	S	SMT37U806M3C	T	3.75

Cap. (μF)	Stock Items	Catalog Number	Case Code	H (inches)
370 Vac 70 °C (cont'd)				
90.0		SMT37U906M3C	T	3.75
100.0		SMT37U107M44	T	4.25
440 Vac 70 °C Case Temperature				
2.0		SMP44U205M24	P	2.25
3.0		SMP44U305M24	P	2.25
4.0		SMP44U405M24	P	2.25
5.0		SMP44U505M24	P	2.25
6.0		SMP44U605M24	P	2.25
7.5	S	SMP44U755M2E	P	2.88
10.0	S	SMP44U106M2E	P	2.88
12.5	S	SMP44U1255M2E	P	2.88
15.0	S	SMP44U156M2E	P	2.88
17.5		SMP44U1755M2E	P	2.88
20.0	S	SMP44U206M2E	P	2.88
25.0		SMS44U256M3C	S	3.75
30.0	S	SMS44U306M3C	S	3.75
35.0		SMT44U356M2E	T	2.88
40.0		SMT44U406M3C	T	3.75
45.0		SMT44U456M3C	T	3.75
50.0		SMT44U506M3C	T	3.75
55.0		SMT44U556M44	T	4.25
60.0	S	SMT44U606M44	T	4.25

High-Voltage and Motor Capacitors