

MULTI-POLE CONNECTORS

Push-Pull Connectors Female Fixed Socket CCM Series CCM1S1/07 7 Pole

- Premium range of circular connectors
- IP68 sealed using vacuum technology (when connected and using environmental cable clamp)
- Tough, high performance interconnection solution
- Compact panel mounting design
- Ideal for harsh and extreme environments
- Suitable for broadcasting, autosport, military, rail, marine, security, industrial and agricultural applications
- Key coded to prevent misconnection
- Will not disconnect when the cable is under load or stress
- Tool slots for secure and tight mounting
- Tested to IEC 60512-3-5a

SPECIFICATIONS

Shell style/model	DEU type fixed socket, female contact
Codes	Code 1
Contact type	Solder type
Contact diameter	0.5mm
Max. stranded conductor	AWG 26-28
Max diameter	0.43mm
Vtest (contact-shell)	800V(AC) 1300V(DC)
Vtest (contact-contact)	1000V(AC) 1800V(DC)
Rated current	2.0A
Rated voltage	≤160V
Mechanical operation	5000 mating cycles
Housing material	Brass (natural chrome plated) shell and collet nut, nickel plated brass latch sleeve and mid pieces
Insulator	PPS
Contacts	Brass (gold plated)
Humidity (max)	≤95% [at 60°C /140°F]
Vibration	15g [10 Hz - 2000 Hz]
Shock resistance	100g [6 ms]
Salt spray corrosion	>72 hr
Climatical category	50/175/21
Shielding (min)	75 dB (10 MHz)
Shielding (min)	40 dB (1 GHz)
IP rating	IP68 (when connected and using environmental cable clamp)

CCM1S1/07

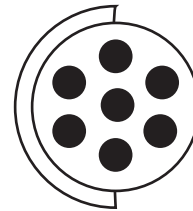
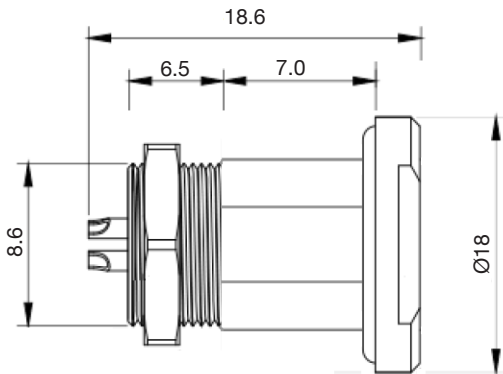

TYPE NO.	DESCRIPTION	NO. POLES	SERIES
CCM1S1/07	Female fixed socket	7	CCM series

ASSEMBLY GUIDE

1. Remove CamCirc plug from packaging

SEALED VERSION

2. Fit cable clamp piece parts over cable

UNSEALED VERSION

Shielded clamp

3. Strip cable and wires
4. Tinning of wire strands recommended to prepare for soldering

SOLDER CONTACTS

5. Solder each wire to the corresponding contact
6. Slide the ring to the front end
7. Bend cable screen outwards
8. Insert half shell and retain with the ring

9. Slide washer, seal and clamp against the ring and retain the screen between ring and washer

12. Screw clamp nut to the body and tighten by means of wrenches.

10. Trim protruding screen strands
11. Push the cable assembly into the body, orienting the guides to the slots

The assembly is now finished

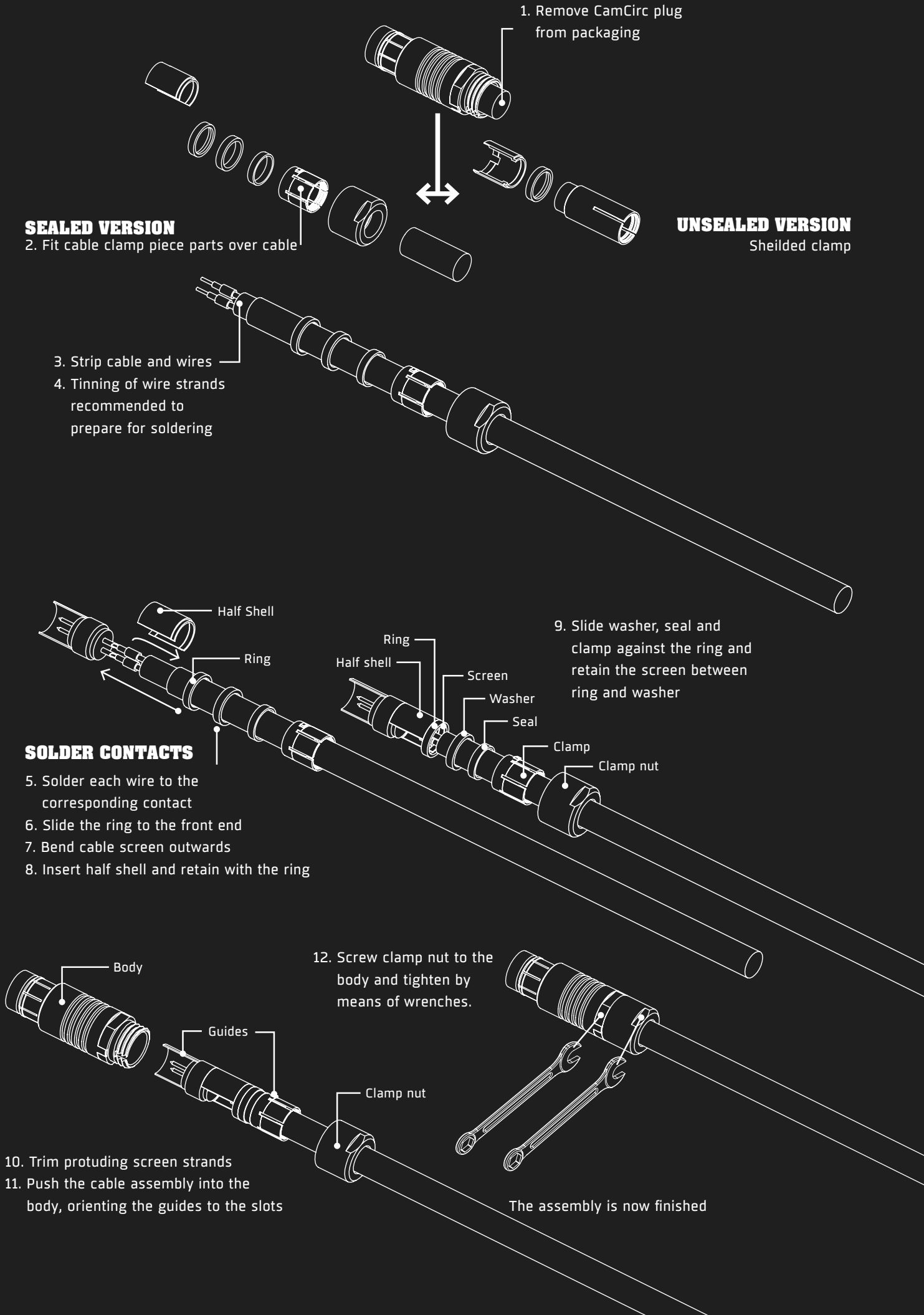



CCB1S1/03

Panel mount
Low profile
3 contacts
Size 1

+

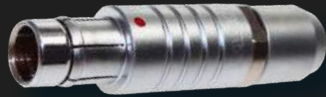

CCA1P1/A03

+



CCV1C/CC	2.6 - 3.1 mm
CCV1C/CD	3.1 - 3.6 mm
CCV1C/CE	3.6 - 4.1 mm
CCV1C/CF	4.1 - 4.3 mm

Non IP68 cable clamps also available

**CCB SERIES
8.2A**

Cable
Diameter

2.6-4.3

(mm)



CCB1S1/04

Panel mount
Low profile
4 contacts
Size 1

+



CCA1P1/A04

+



CCV1C/CC	2.6 - 3.1 mm
CCV1C/CD	3.1 - 3.6 mm
CCV1C/CE	3.6 - 4.1 mm
CCV1C/CF	4.1 - 4.3 mm

Non IP68 cable clamps also available

**CCB SERIES
5.5A**

Cable
Diameter

2.6-4.3

(mm)



CCB2S1/03

Panel mount
Low profile
3 contacts
Size 2

+



CCA2P1/A03

+



CCV2C/CE	3.7 - 4.2 mm
CCV2C/CG	4.2 - 4.7 mm
CCV2C/CH	4.7 - 5.2 mm
CCV2C/CI	5.2 - 5.7 mm
CCV2C/CJ	5.7 - 6.2 mm

Non IP68 cable clamps also available

**CCB SERIES
12A**

Cable
Diameter

3.7-6.2

(mm)



CCB SERIES 7A

Cable Diameter

3.7-6.2

(mm)



+



+



CCB2S1/04

Panel mount
Low profile
4 contacts
Size 2

CCA2P1/A04

CCV2C/CE
CCV2C/CG
CCV2C/CH
CCV2C/CI
CCV2C/CJ

3.7 - 4.2 mm
4.2 - 4.7 mm
4.7 - 5.2 mm
5.2 - 5.7 mm
5.7 - 6.2 mm

Non IP68 cable clamps also available



CCB SERIES 5.2A

Cable Diameter

3.7-6.2

(mm)



+

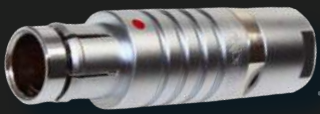

+



CCB2S1/06

Panel mount
Low profile
6 contacts
Size 2

CCA2P1/A06

CCV2C/CE
CCV2C/CG
CCV2C/CH
CCV2C/CI
CCV2C/CJ

3.7 - 4.2 mm
4.2 - 4.7 mm
4.7 - 5.2 mm
5.2 - 5.7 mm
5.7 - 6.2 mm

Non IP68 cable clamps also available



CCB SERIES 5A

Cable Diameter

3.7-6.2

(mm)



+



+



CCB2S1/07

Panel mount
Low profile
7 contacts
Size 2

CCA2P1/A07

CCV2C/CE
CCV2C/CG
CCV2C/CH
CCV2C/CI
CCV2C/CJ

3.7 - 4.2 mm
4.2 - 4.7 mm
4.7 - 5.2 mm
5.2 - 5.7 mm
5.7 - 6.2 mm

Non IP68 cable clamps also available



CCB2S1/08

Panel mount
Low profile
8 contacts
Size 2

+



CCA2P1/A08

+



CCV2C/CE	3.7 - 4.2 mm
CCV2C/CG	4.2 - 4.7 mm
CCV2C/CH	4.7 - 5.2 mm
CCV2C/CI	5.2 - 5.7 mm
CCV2C/CJ	5.7 - 6.2 mm

Non IP68 cable clamps also available

CCB SERIES 3.8A

Cable
Diameter

3.7-6.2

(mm)



CCB3S1/19

Panel mount
Low profile
19 contacts
Size 3

+



CCA3P1/A19

+



CCU3C/CJ	5.7 - 6.2 mm
CCU3C/CL	6.2 - 6.7 mm

Non IP68 cable clamps also available

CCB SERIES 2.5A

Cable
Diameter

5.7-6.7

(mm)



CCB4S1/19

Panel mount
Low profile
19 contacts
Size 4

+

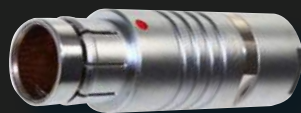

CCA4P1/A19

+



CCU4C/CK	5.7 - 6.7 mm
CCU4C/CN	6.7 - 7.7 mm
CCU4C/CQ	7.7 - 8.7 mm

Non IP68 cable clamps also available

CCM SERIES 2.5A

Cable
Diameter

5.7-8.7

(mm)



CCD SERIES 7A

Cable
Diameter



+



+



CCD2S1/04

Panel mount
Protruding for low light conditions
4 contacts
Size 2

CCA2P1/A04

CCV2C/CE	3.7 - 4.2 mm
CCV2C/CG	4.2 - 4.7 mm
CCV2C/CH	4.7 - 5.2 mm
CCV2C/CI	5.2 - 5.7 mm
CCV2C/CJ	5.7 - 6.2 mm

Non IP68 cable clamps also available

3.7-6.2

(mm)



CCE SERIES 8.2A

Cable
Diameter



+

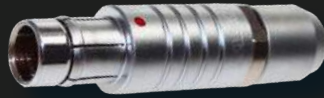

+



CCE1S1/03

Panel mount
Protruding for low light conditions
3 contacts
Size 1

CCA1P1/A03

CCV1C/CC	2.6 - 3.1 mm
CCV1C/CD	3.1 - 3.6 mm
CCV1C/CE	3.6 - 4.1 mm
CCV1C/CF	4.1 - 4.3 mm

Non IP68 cable clamps also available

2.6-4.3

(mm)



CCE SERIES 5.2A

Cable
Diameter



+



+



CCE1S1/05

Panel mount
Protruding for low light conditions
5 contacts
Size 1

CCA1P1/A05

CCV1C/CC	2.6 - 3.1 mm
CCV1C/CD	3.1 - 3.6 mm
CCV1C/CE	3.6 - 4.1 mm
CCV1C/CF	4.1 - 4.3 mm

Non IP68 cable clamps also available

2.6-4.3

(mm)



CCE1S1/07

Panel mount
Protruding for low light conditions
7 contacts
Size 1



CCA1P1/A07



CCV1C/CC	2.6 - 3.1 mm
CCV1C/CD	3.1 - 3.6 mm
CCV1C/CE	3.6 - 4.1 mm
CCV1C/CF	4.1 - 4.3 mm

Non IP68 cable clamps also available

CCE SERIES 2A

Cable Diameter

2.6-4.3
(mm)



CCE2S1/07

Panel mount
Protruding for low light conditions
7 contacts
Size 2



CCA2P1/A07



CCV2C/CE	3.7 - 4.2 mm
CCV2C/CG	4.2 - 4.7 mm
CCV2C/CH	4.7 - 5.2 mm
CCV2C/CI	5.2 - 5.7 mm
CCV2C/CJ	5.7 - 6.2 mm

Non IP68 cable clamps also available

CCE SERIES 5A

Cable Diameter

3.7-6.2
(mm)

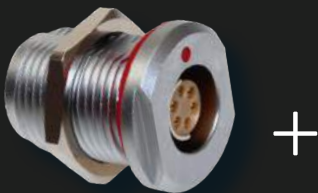

CCL2S1/06

Panel mount
Utility style
6 contacts
Size 2



CCA2P1/A06



CCV2C/CE	3.7 - 4.2 mm
CCV2C/CG	4.2 - 4.7 mm
CCV2C/CH	4.7 - 5.2 mm
CCV2C/CI	5.2 - 5.7 mm
CCV2C/CJ	5.7 - 6.2 mm

Non IP68 cable clamps also available

CCL SERIES 5.2A

Cable Diameter

3.7-6.2
(mm)



CCM SERIES 8.2A

Cable
Diameter

2.6-4.3
(mm)

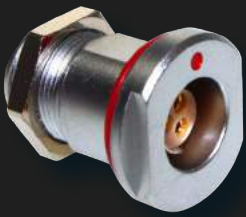

+



+



CCM1S1/03

Panel mount
Thick panel type
3 contacts
Size 1

CCA1P1/A03

CCV1C/CC	2.6 - 3.1 mm
CCV1C/CD	3.1 - 3.6 mm
CCV1C/CE	3.6 - 4.1 mm
CCV1C/CF	4.1 - 4.3 mm

Non IP68 cable clamps also available



CCM SERIES 5.2A

Cable
Diameter

2.6-4.3
(mm)

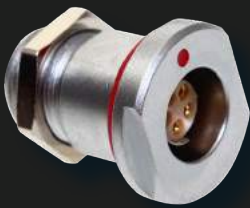

+



+



CCM1S1/05

Panel mount
Thick panel type
5 contacts
Size 1

CCA1P1/A05

CCV1C/CC	2.6 - 3.1 mm
CCV1C/CD	3.1 - 3.6 mm
CCV1C/CE	3.6 - 4.1 mm
CCV1C/CF	4.1 - 4.3 mm

Non IP68 cable clamps also available



CCM SERIES 2A

Cable
Diameter

2.6-4.3
(mm)



+



+



CCM1S1/07

Panel mount
Thick panel type
7 contacts
Size 1

CCA1P1/A07

CCV1C/CC	2.6 - 3.1 mm
CCV1C/CD	3.1 - 3.6 mm
CCV1C/CE	3.6 - 4.1 mm
CCV1C/CF	4.1 - 4.3 mm

Non IP68 cable clamps also available



CCM SERIES 1.7A

Cable
Diameter

2.6-4.3

(mm)

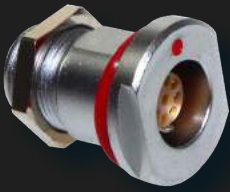

+



+



CCM1S1/09

Panel mount
Thick panel type
9 contacts
Size 1

CCA1P1/A09

CCV1C/CC	2.6 - 3.1 mm
CCV1C/CD	3.1 - 3.6 mm
CCV1C/CE	3.6 - 4.1 mm
CCV1C/CF	4.1 - 4.3 mm

Non IP68 cable clamps also available



CCM SERIES 6.8A

Cable
Diameter

3.7-6.2

(mm)



+



+



CCM2S1/05

Panel mount
Utility style
5 contacts
Size 2

CCA2P1/A05

CCV2C/CE	3.7 - 4.2 mm
CCV2C/CG	4.2 - 4.7 mm
CCV2C/CH	4.7 - 5.2 mm
CCV2C/CI	5.2 - 5.7 mm
CCV2C/CJ	5.7 - 6.2 mm

Non IP68 cable clamps also available



CCM SERIES 5A

Cable
Diameter

3.7-6.2

(mm)



+



+



CCM2S1/07

Panel mount
Utility style
7 contacts
Size 2

CCA2P1/A07

CCV2C/CE	3.7 - 4.2 mm
CCV2C/CG	4.2 - 4.7 mm
CCV2C/CH	4.7 - 5.2 mm
CCV2C/CI	5.2 - 5.7 mm
CCV2C/CJ	5.7 - 6.2 mm

Non IP68 cable clamps also available



CCM SERIES 4.5A

Cable
Diameter

5.7-6.7

(mm)



+

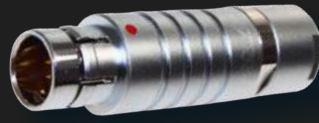

+



CCM3S1/10

Panel mount
Utility style
10 contacts
Size 3

CCA3P1/A10

CCU3C/CJ
CCU3C/CL

5.7 - 6.2 mm
6.2 - 6.7 mm

Non IP68 cable clamps also available



CCM SERIES 4.2A

Cable
Diameter

5.7-6.7

(mm)

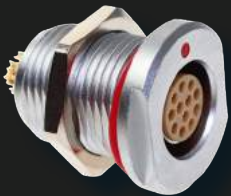

+

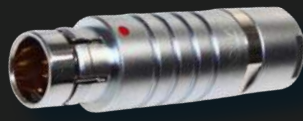

+



CCM3S1/12

Panel mount
Utility style
12 contacts
Size 3

CCA3P1/A12

CCU3C/CJ
CCU3C/CL

5.7 - 6.2 mm
6.2 - 6.7 mm

Non IP68 cable clamps also available



CCM SERIES 4A

Cable
Diameter

5.7-8.7

(mm)

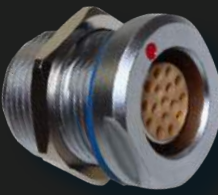

+



+



CCM4S1/16

Panel mount
Utility style
16 contacts
Size 4

CCA4P1/A16

CCU4C/CK
CCU4C/CN
CCU4C/CQ

5.7 - 6.7 mm
6.7 - 7.7 mm
7.7 - 8.7 mm

Non IP68 cable clamps also available



CCS SERIES 5.5A

Cable
Diameter

2.6-4.3
(mm)

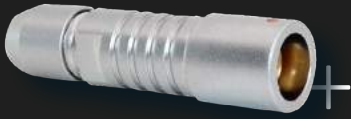

CCS1S1/04

Cable mount
4 contacts
Size 1

Please note, cable mount receptacles require a cable clamp

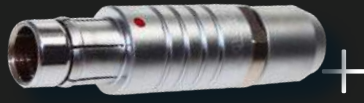

CCA1P1/A04



CCV1C/CC	2.6 - 3.1 mm
CCV1C/CD	3.1 - 3.6 mm
CCV1C/CE	3.6 - 4.1 mm
CCV1C/CF	4.1 - 4.3 mm

Non IP68 cable clamps also available



CCT SERIES 8.2A

Cable
Diameter

2.6-4.3
(mm)



CCT1S1/03

Cable mount
3 contacts
Size 1

Please note, cable mount receptacles require a cable clamp

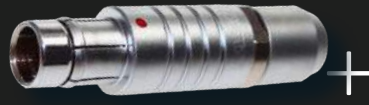

CCA1P1/A03



CCV1C/CC	2.6 - 3.1 mm
CCV1C/CD	3.1 - 3.6 mm
CCV1C/CE	3.6 - 4.1 mm
CCV1C/CF	4.1 - 4.3 mm

Non IP68 cable clamps also available



CCT SERIES 5.2A

Cable
Diameter

2.6-4.3
(mm)

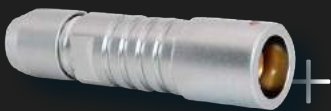

CCT1S1/05

Cable mount
5 contacts
Size 1

Please note, cable mount receptacles require a cable clamp



CCA1P1/A05



CCV1C/CC	2.6 - 3.1 mm
CCV1C/CD	3.1 - 3.6 mm
CCV1C/CE	3.6 - 4.1 mm
CCV1C/CF	4.1 - 4.3 mm

Non IP68 cable clamps also available



CCT SERIES 2A

Cable
Diameter

2.6-4.3
(mm)

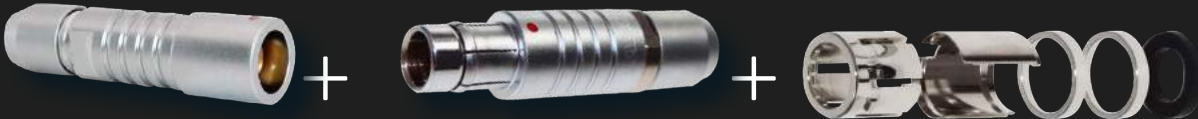

CCT1S1/07

Cable mount
7 contacts
Size 1

Please note, cable mount receptacles require a cable clamp

CCA1P1/A07

CCV1C/CC
CCV1C/CD
CCV1C/CE
CCV1C/CF

2.6 - 3.1 mm
3.1 - 3.6 mm
3.6 - 4.1 mm
4.1 - 4.3 mm

Non IP68 cable clamps also available



CCT SERIES 6.8A

Cable
Diameter

3.7-6.2
(mm)



CCT2S1/05

Cable mount
5 contacts
Size 2

Please note, cable mount receptacles require a cable clamp

CCA2P1/A05

CCV2C/CE
CCV2C/CG
CCV2C/CH
CCV2C/CI
CCV2C/CJ

3.7 - 4.2 mm
4.2 - 4.7 mm
4.7 - 5.2 mm
5.2 - 5.7 mm
5.7 - 6.2 mm

Non IP68 cable clamps also available



CCT SERIES 5A

Cable
Diameter

3.7-6.2
(mm)



CCT2S1/07

Cable mount
7 contacts
Size 2

Please note, cable mount receptacles require a cable clamp

CCA2P1/A07

CCV2C/CE
CCV2C/CG
CCV2C/CH
CCV2C/CI
CCV2C/CJ

3.7 - 4.2 mm
4.2 - 4.7 mm
4.7 - 5.2 mm
5.2 - 5.7 mm
5.7 - 6.2 mm

Non IP68 cable clamps also available