



Product Change Notification

ESD PROTECTION PRODUCTS

May, 2008

Bourns Manufacturers Representatives
Corporate Distributor Product Managers
Americas Sales Team
Asia Sales Team
Europe Sales Team
Bourns Internal

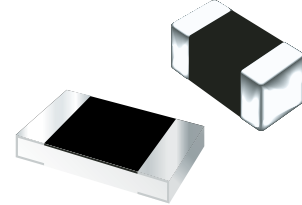

Bourns® Chip Guard® ESD Protection Products

Bourns ESD Product Line has successfully provided the [CG0603MLC-05E](#) and [CG0603MLC-12E](#) Chip Guard® ESD Suppressor products for over five years. To maintain price competitiveness and continued product supply, a material change is required to these two part numbers.

Bourns will be changing the internal electrode material from PdAg (Palladium Silver) to Pt (Platinum). The change of internal material does NOT affect form, fit or function. There is no change to the part number.

The new CG0603MLC-05E and CG0603MLC-12E parts are available to ship as of May 1, 2008. Production of the original version will cease on July 1, 2008.

Full AEC-Q200 reliability test data and updated Material Declaration Sheets are available. Product data sheets with detailed specifications can be viewed on the Bourns website at www.bourns.com.

For further application support, please contact:

Asia:

Lancelot Chen
Tel: +886 2 2562 4117
Email: lancelot.chen@bourns.com

Europe:

Johan Enoksson
Tel: +46 8 57142070
Email: johan.enoksson@bourns.com

Americas:

Tim Ardley
Tel: +1 951 781 5317
Email: tim.ardley@bourns.com

If you have any questions, please contact our FAEs above or myself at ian.doyle@bourns.com.

Best regards,

Ian Doyle
Bourns ESD Product Line Manager

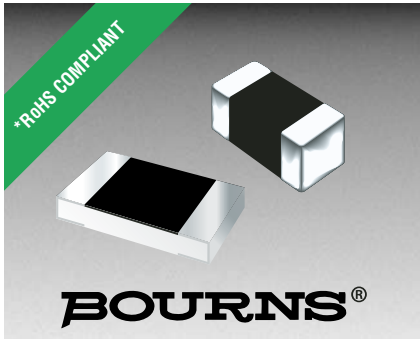

Features

- RoHS compliant*
- ESD protection >25 kV
- Low capacitance <0.5 pF
- Low leakage current <50 nA

Applications

- Antenna protection
- Memory / SIM card protection
- HDMI / DVI port protection
- USB 2.0 / IEEE1394 port protection

ChipGuard® MLC Series - ESD Protectors

General Information

The ChipGuard® MLC Series has been specifically designed to protect sensitive electronic components from electrostatic discharge damage. The MLC family has been designed to protect equipment to IEC61000-4-2, Level 4 (± 8 kV Contact / ± 15 kV Air Discharge) ESD specifications targeted for high speed USB 2.0, HDMI, DVI or IEEE1394 applications.

The ChipGuard® MLC Series has been manufactured to provide low 0.5 pF capacitance and leakage currents less than 50 nA with excellent clamp qualities, making the family almost transparent under normal working conditions.

Device Symbol



Electrical Characteristics @ 25 °C (unless otherwise noted)

Parameter	Symbol	CG0402MLC-						CG0603MLC-						Unit		
		3.3LG	05LG	12LG	3.3LGA	05LGA	12LGA	3.3LE	05E	05LE	12E	12LE	3.3LEA		05LEA	12LEA
Typical Continuous Operating Voltage	V _{DC}	3.3	5	12	3.3	5	12	3.3	5	5	12	12	3.3	5	12	V
Typical Clamping Voltage (Note 1)	V _C	25	25	25	25	25	25	25	20	25	30	25	25	25	25	V
Maximum Capacitance @ 1V _{RMS} 1MHz	C _O	0.5														pF
Maximum Leakage Current @ Max. V _{DC}	I _L	5	5	5	5	5	5	5	50	5	50	5	5	5	5	nA
Typical Trigger Voltage (Note 2)	V _T	250	250	250	250	250	250	250	150	250	150	250	250	250	250	V
Maximum Response Time	R _T	1														nS
ESD Protection: Per IEC 61000-4-2 Level 4 Min. Contact Discharge Min. Air Discharge Min. Air Discharge		± 8 (100 Repts Min.) ± 15 (100 Repts Min., See Note 3) ± 25 (100 Repts Min.)														kV kV kV
Operating Temperature	T _{OPR}	-40 to +85			-40 to +125			-40 to +85			-40 to +125			°C		
Storage Temperature	T _{STG}	-55 to +150														°C

- Notes: 1. Per IEC 61000-4-2, Level 4 8 kV Contact Discharge. Measurement 30 ns after initiation of pulse.
 2. Per IEC 61000-4-2, Level 4 8 kV Contact Discharge. Measurement at maximum pulse voltage.
 3. Some shifting in characteristics may occur when tested over several hundred ESD pulses.

Product Dimensions

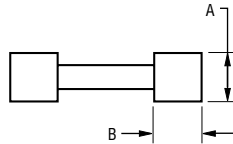
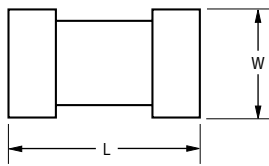

DIMENSIONS = $\frac{\text{MM}}{\text{(INCHES)}}$

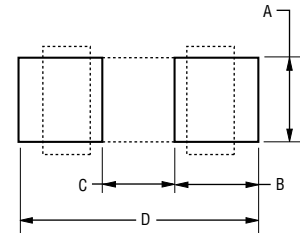

Dimension	CG0402 Series	CG0603 Series
L	$\frac{1.00 \pm 0.15}{(0.04 \pm 0.006)}$	$\frac{1.60 \pm 0.20}{(0.064 \pm 0.008)}$
W	$\frac{0.50 \pm 0.10}{(0.02 \pm 0.004)}$	$\frac{0.80 \pm 0.20}{(0.032 \pm 0.008)}$
A	$\frac{0.36 \pm 0.05}{(0.014 \pm 0.002)}$	$\frac{0.45 \pm 0.10}{(0.018 \pm 0.004)}$
B	$\frac{0.25 \pm 0.15}{(0.10 \pm 0.006)}$	$\frac{0.30 \pm 0.20}{(0.012 \pm 0.008)}$

Dim.	CG0402 Series	CG0603 Series
A	$\frac{0.51}{(0.020)}$	$\frac{0.76}{(0.030)}$
B	$\frac{0.61}{(0.024)}$	$\frac{1.02}{(0.040)}$
C	$\frac{0.51}{(0.020)}$	$\frac{0.50}{(0.020)}$
D	$\frac{1.70}{(0.067)}$	$\frac{2.54}{(0.100)}$

Solder Reflow Recommendations

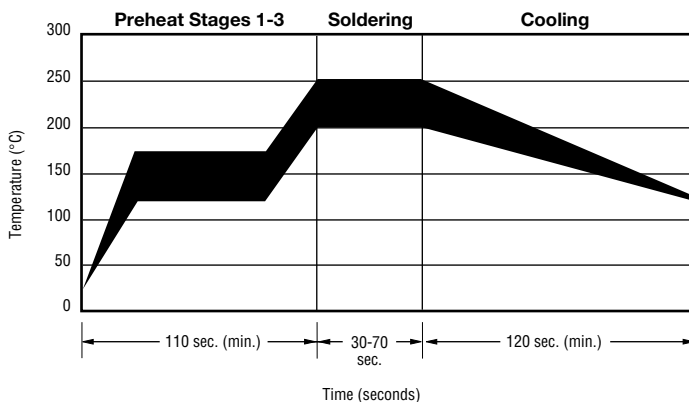

Dim.	Stage	Temperature	Time
A	Stage 1 Preheat	Ambient to Preheating Temperature	30 s to 60 s
B	Stage 2 Preheat	140 °C to 160 °C	60 s to 120 s
C	Stage 3 Preheat	Preheat to 200 °C	20 s to 40 s
D	Main Heating	200 °C 210 °C 220 °C 230 °C 240 °C	60 s to 70 s 55 s to 65 s 50 s to 60 s 40 s to 50 s 30 s to 40 s
E	Cooling	200 °C to 100 °C	1 °C/s to 4 °C/s

- ⚠ This product can be damaged by rapid heating, cooling or localized heating.
- Heat shocks should be avoided. Preheating and gradual cooling recommended.
 - Excessive solder can damage the device. Print solder thickness of 150 to 200 um recommended.
 - Solder gun tip temperature should be kept below 280 °C and should not touch the device directly. Contact should be less than 3 seconds. A solder gun under 30 watts is recommended.

Packaging Dimensions

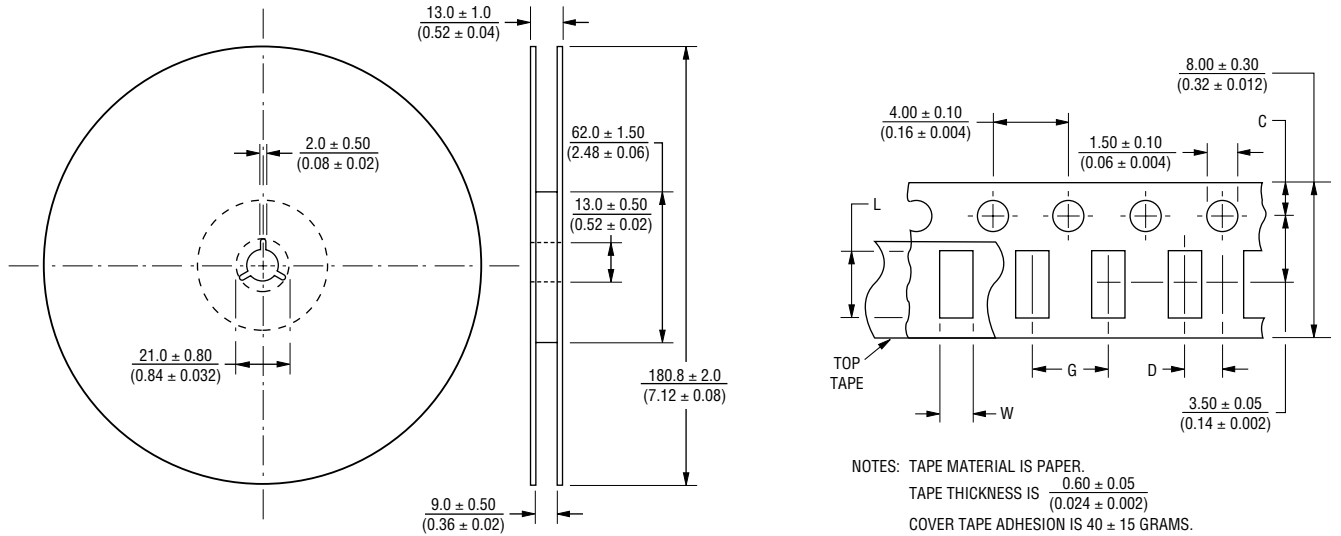

How to Order

CG 0402 MLC - 12 L G A

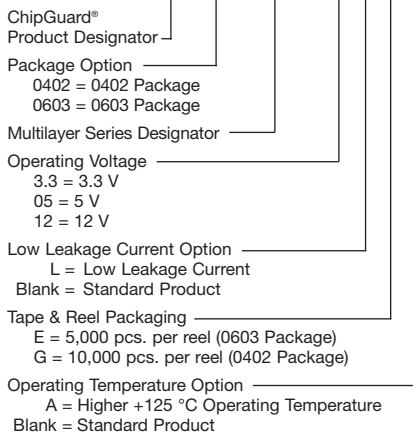

Dimension	CG0402 Series	CG0603 Series
C	$\frac{1.75 \pm 0.05}{(0.04 \pm 0.002)}$	$\frac{1.75 \pm 0.10}{(0.04 \pm 0.004)}$
D	$\frac{2.00 \pm 0.02}{(0.08 \pm 0.0008)}$	$\frac{2.00 \pm 0.05}{(0.08 \pm 0.002)}$
L	$\frac{1.12 \pm 0.03}{(0.045 \pm 0.0012)}$	$\frac{1.80 \pm 0.20}{(0.072 \pm 0.008)}$
W	$\frac{0.62 \pm 0.03}{(0.025 \pm 0.0012)}$	$\frac{0.90 \pm 0.20}{(0.036 \pm 0.008)}$
G	$\frac{2.0 \pm 0.05}{(0.08 \pm 0.002)}$	$\frac{4.0 \pm 0.05}{(0.16 \pm 0.002)}$



Asia-Pacific: TEL +886-2 25624117 • FAX +886-2 25624116
 Europe: TEL +41-41 7685555 • FAX +41-41 7685510
 The Americas: TEL +1-951 781-5500 • FAX +1-951 781-5700
www.bourns.com