

1.0mm Pitch
SERIES

6232

1.0mmピッチ NON-ZIF ストレート SMT 片面接点
1.0mmPitch LIF Vertical SMT Single-sided contact

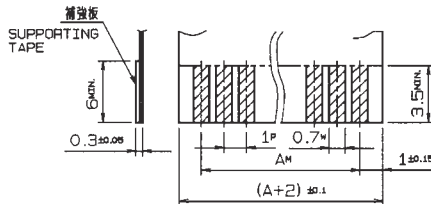
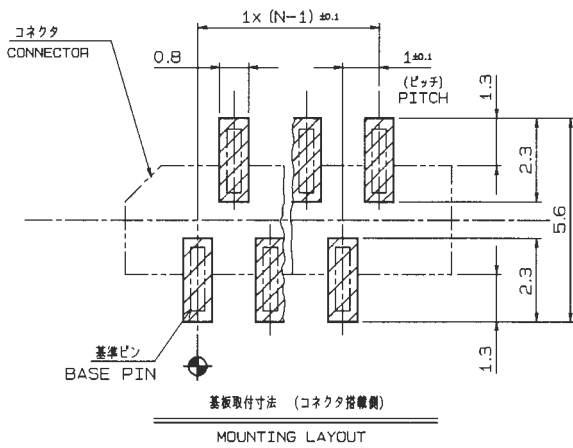
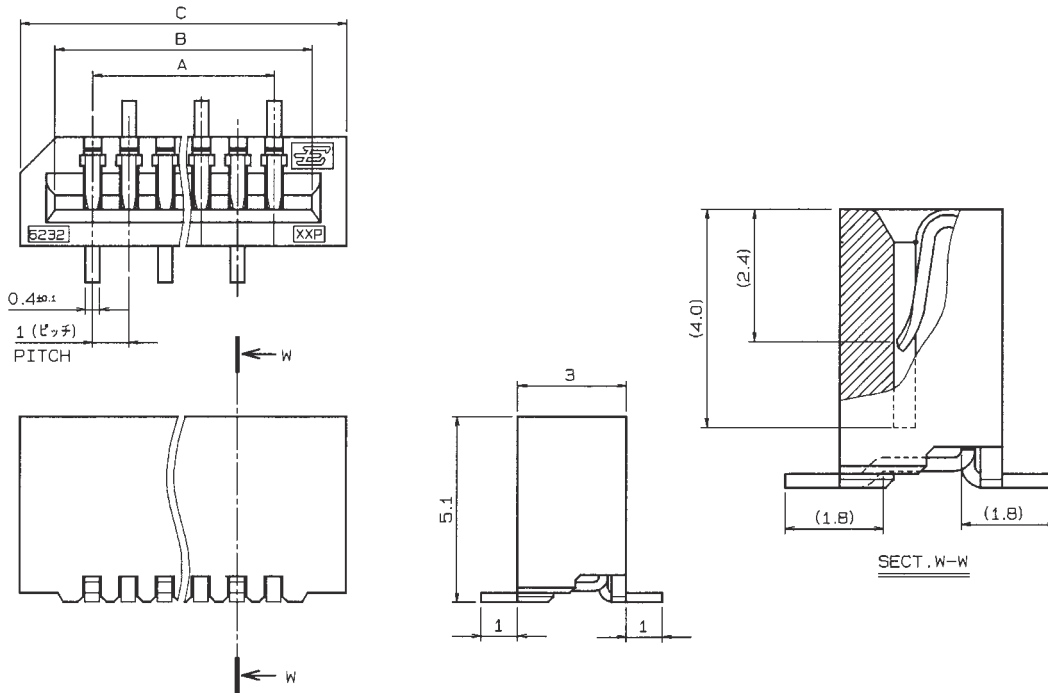

種類 KIND	公差 TOLERANCE		
	P	W	M
FPC	±0.02	+0.1 -0.05	±0.05
FFC	±0.05	±0.03	±0.1

極数 NO. OF POS	型番 ASSEMBLY NUMBER	A	B	C
3	00 6232 103 006 800+	2.0	4.1	6.0
4	↑ 104 ↑	3.0	5.1	7.0
5	105	4.0	6.1	8.0
6	106	5.0	7.1	9.0
7	107	6.0	8.1	10.0
8	108	7.0	9.1	11.0
9	109	8.0	10.1	12.0
10	110	9.0	11.1	13.0
11	111	10.0	12.1	14.0
12	112	11.0	13.1	15.0
13	113	12.0	14.1	16.0
14	114	13.0	15.1	17.0
15	115	14.0	16.1	18.0
16	116	15.0	17.1	19.0
17	117	16.0	18.1	20.0
18	118	17.0	19.1	21.0
19	119	18.0	20.1	22.0
20	120	19.0	21.1	23.0
21	121	20.0	22.1	24.0
22	122	21.0	23.1	25.0
23	123	22.0	24.1	26.0
24	124	23.0	25.1	27.0
25	125	24.0	26.1	28.0
26	126	25.0	27.1	29.0
27	127	26.0	28.1	30.0
28	128	27.0	29.1	31.0
29	↓ 129 ↓	28.0	30.1	32.0
30	00 6232 130 006 800+	29.0	31.1	33.0

注文コード ORDERING CODE

00 6232 1XX 006 800+

RoHS 対応品

RoHS Compliant Product

極数
NUMBER OF
POSITIONS

スズ銅めっき Sn-Cu Plated

00: トレー梱包
TRAY PACKAGE

エンボス梱包品: 04 6232 1XX 015 800+
Tape & Reel Package: 04 6232 1XX 015 800+

生産対応可能極数については、営業部にご確認願います。
Feel free to contact our sales department for available numbers of positions.

1.0mm Pitch
SERIES

6232 エンボス梱包品 Tape and Reel Package

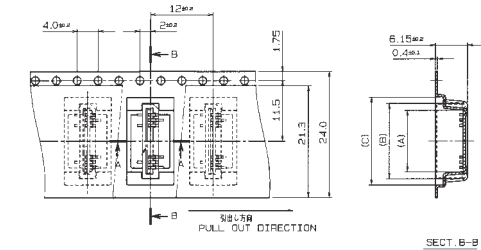

型番	個数	A	B	C
04 6232 103 015 800+	3	3.7	6.3	8.7
↑	4	4.7	7.3	9.7
↑	5	5.7	8.3	10.7
↑	6	6.7	9.3	11.7
↑	7	7.7	10.3	12.7
↑	8	8.7	11.3	13.7
↑	9	9.7	12.3	14.7
↑	10	10.7	13.3	15.7
04 6232 111 015 800+	11	11.7	14.3	16.7

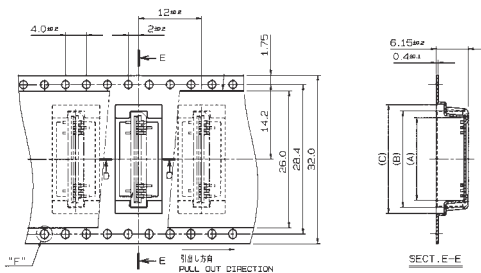

型番	個数	A	B	C
04 6232 112 015 800+	12	12.7	15.3	17.7
↑	13	13.7	16.3	18.7
↑	14	14.7	17.3	19.7
↑	15	15.7	18.3	20.7
↑	16	16.7	19.3	21.7
↑	17	17.7	20.3	22.7
04 6232 118 015 800+	18	18.7	21.3	23.7

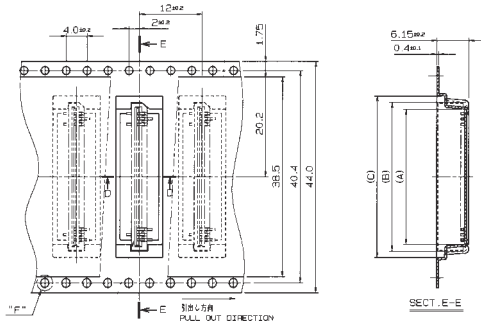

型番	個数	A	B	C
04 6232 119 015 800+	19	19.7	22.3	24.7
↑	20	20.7	23.3	25.7
↑	21	21.7	24.3	26.7
↑	22	22.7	25.3	27.7
↑	23	23.7	26.3	28.7
↑	24	24.7	27.3	29.7
04 6232 125 015 800+	25	25.7	28.3	30.7

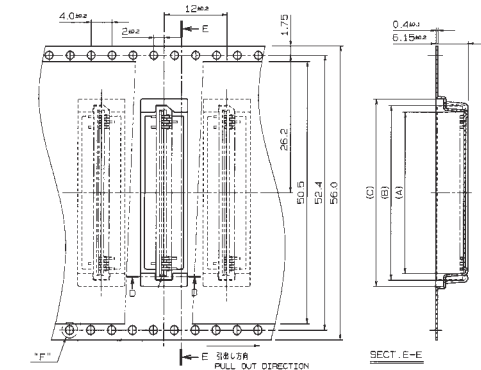

型番	個数	A	B	C
04 6232 126 015 800+	26	26.7	29.3	31.7
↑	27	27.7	30.3	32.7
↑	28	28.7	31.3	33.7
↑	29	29.7	32.3	34.7
04 6232 130 015 800+	30	30.7	33.3	35.7

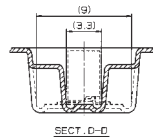

生産対応可能極数については、営業部
にご確認願います。
Feel free to contact our sales
department for available numbers
of positions.

注文コード ORDERING CODE

04 6232 1XX 015 800+

RoHS 対応品

RoHS Compliant Product

NUMBER OF
POSITIONS

極数

スズ銅めっき Sn-Cu Plated

04 : エンボス梱包
Tape & Reel

トレー梱包品 : 00 6232 1XX 006 800+
Tray Package : 00 6232 1XX 006 800+

梱包数量 900個/リール
PACKING QUANTITY : 900/Reel