

TUNING

FAI* RoHS Compliant

TUNING

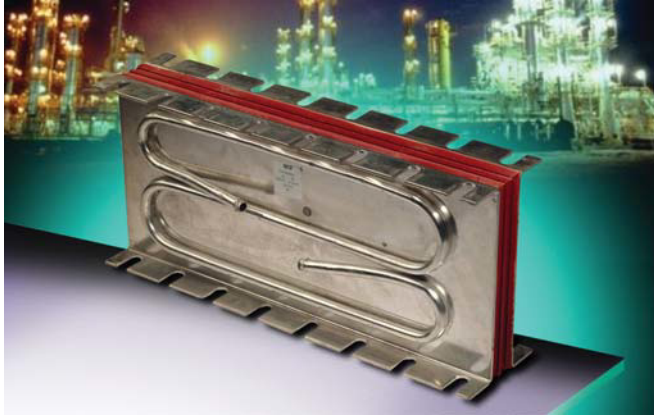

The FAI series uses metallized polypropylene dielectric specifically designed for very high reactive power.

The FAI's special design gives to this series a very low level of stray inductance.

APPLICATIONS

These capacitors have been designed principally for: low and medium frequency applications (10 kHz to 500 kHz).

MAXIMUM WORKING TEMPERATURE (HOT SPOT)

+85°C: Hot spot temperature must be calculated as function of power dissipation.

HOT SPOT (THERMAL) CALCULATION

See Hot Spot Temperature page 3.

You can calculate the maximum operating (hot spot) temperature of this capacitor in the following manner:

Polypropylene has a constant loss factor ($tg\delta_0$) of 2×10^{-4} irrespective of temperature and frequency (up to 1 MHz).

The loss factor of the capacitor is made up of the sum of two components. The first represents electrical losses ($tg\delta_0 = 2.10^{-4}$) and the second represents Joule effect in the connection and foils: $R_s \cdot C \cdot 2\pi F$.

For all applications, the temperature in the hot spot capacitor must be lower than 85°C.

$$\theta_{hot\ spot} = \theta_{terminals} + (tg\delta_0 \cdot Q + R_s \cdot (I_{rms})^2) \cdot R_{th}$$

Heating calculation of hot spot capacitor: FAI6

$$\theta_{hot\ spot} = \theta_{water} + (tg\delta_0 \cdot Q + R_s \cdot (I_{rms})^2) \cdot R_{th}$$

With: $tg\delta_0 = 2.10^{-4}$

Q in Var

R_s in Ohms

I_{rms} in Amperes

R_{th} in °C/W (water flow = 10 dm³/minute)

Note: The life time depends of hot spot temperature, see following curve.

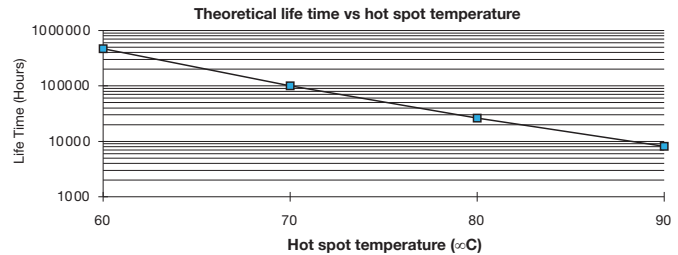

ELECTRICAL CHARACTERISTICS

| | |
|---------------------------------------|-----------------------|
| Capacitance range C_n | 110nF to 60µF |
| Tolerance | ±10% |
| Rated AC voltage | 200 to 650 Vrms |
| Series parasitic inductance | < 5 nH |
| Test voltage between terminals @ 25°C | 1.2 Vrms 50/60 Hz 10s |
| Dielectric | Polypropylene |

HOW TO ORDER

FAI

Series

1

Case Size

1
2
3
4
5
6

6

Dielectric
6 = Polypropylene

J

Voltage Code

H = 300 Vrms
I = 350 Vrms (Case size 3)
J = 400 Vrms (Case size 4)
K = 500 Vrms
K = 60 Vrms

0114

Capacitance Code

0 + pF code
0114 = 0.11µF (110nF)
0245 = 2.4µF (2400nF)
0405 = 4.0µF (4000nF)
etc.

K

Capacitance Tolerances

K = ±10%

--

Terminal Code

-- = Standard



TUNING

FAI* RoHS Compliant

TUNING FAI1 STYLE CASE SIZE 1 DIMENSIONS

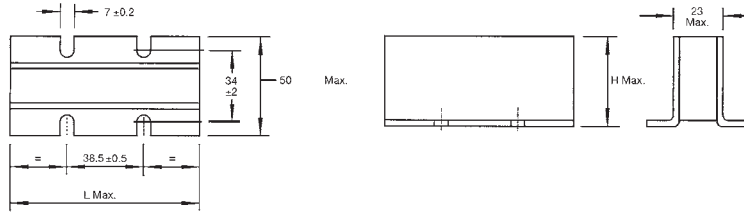

| Part Number | C (nF) | Irms max (A) | Vrms max (V) | Q max kVARs | Rs (mΩ) | Rth (°C/W) | L max (mm) | H max (mm) | Typical Weight (g) |
|--------------|--------|--------------|--------------|-------------|---|------------|------------|------------|--------------------|
| FAI16J0114K- | 110 | 180 | 500 | 100 | $8 \times 10^{-4} \times \sqrt{F} + 0.19$ | 0.86 | 55 | 35 | 125 |
| FAI16J0214K- | 210 | 300 | 500 | 150 | $5 \times 10^{-4} \times \sqrt{F} + 0.12$ | 0.67 | 75 | 40 | 195 |
| FAI16J0334K- | 330 | 350 | 500 | 175 | $5 \times 10^{-4} \times \sqrt{F} + 0.15$ | 0.54 | 75 | 40 | 195 |
| FAI16J0514K- | 510 | 500 | 500 | 250 | $4 \times 10^{-4} \times \sqrt{F} + 0.08$ | 0.49 | 95 | 45 | 275 |
| FAI16J0664K- | 660 | 600 | 500 | 300 | $3.5 \times 10^{-4} \times \sqrt{F} + 0.06$ | 0.38 | 95 | 45 | 275 |

With F in Hz

FAI2 STYLE CASE SIZE 2 DIMENSIONS

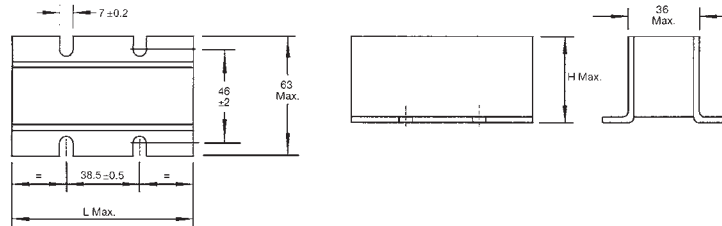

| Part Number | C (nF) | Irms max (A) | Vrms max (V) | Q max kVARs | Rs (mΩ) | Rth (°C/W) | L max (mm) | H max (mm) | Typical Weight (g) |
|--------------|--------|--------------|--------------|-------------|---|------------|------------|------------|--------------------|
| FAI26J0664K- | 660 | 300 | 500 | 180 | $5 \times 10^{-4} \times \sqrt{F} + 0.25$ | 0.6 | 75 | 40 | 300 |
| FAI26J0125K- | 1200 | 400 | 500 | 200 | $5 \times 10^{-4} \times \sqrt{F} + 0.20$ | 0.56 | 75 | 40 | 300 |
| FAI26I0245K- | 2400 | 500 | 350 | 175 | $5 \times 10^{-4} \times \sqrt{F} + 0.17$ | 0.55 | 75 | 40 | 300 |

With F in Hz

FAI3 STYLE CASE SIZE 3 DIMENSIONS

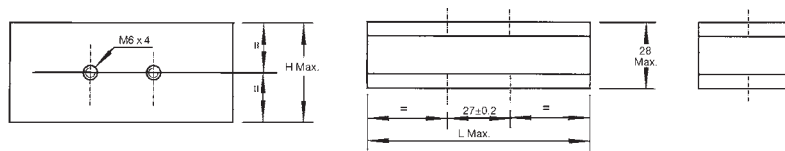

| Part Number | C (nF) | Irms max (A) | Vrms max (V) | Q max kVARs | Rs (mΩ) | Rth (°C/W) | L max (mm) | H max (mm) | Typical Weight (g) |
|--------------|--------|--------------|--------------|-------------|---------|------------|------------|------------|--------------------|
| FAI36J0114K- | 110 | 180 | 500 | 100 | 0.3 | 0.82 | 55 | 35 | 150 |
| FAI36J0334K- | 330 | 350 | 500 | 175 | 0.15 | 0.55 | 75 | 37 | 220 |
| FAI36J0514K- | 510 | 500 | 500 | 250 | 0.1 | 0.3 | 95 | 42 | 315 |
| FAI36J0664K- | 660 | 600 | 500 | 300 | 0.1 | 0.24 | 95 | 42 | 315 |

FAI4 STYLE CASE SIZE 4 DIMENSIONS

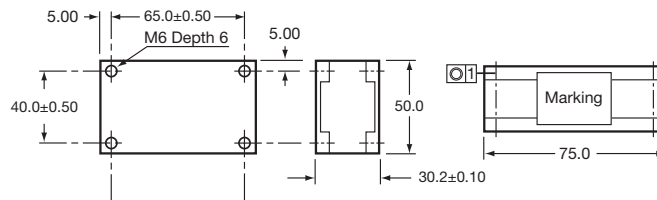

| Part Number | C (nF) | Irms max (A) | Vrms max (V) | Q max kVARs | Rs (mΩ) | Rth (°C/W) | Typical Weight (g) |
|--------------|--------|--------------|--------------|-------------|---------|------------|--------------------|
| FAI46H0405K- | 4000 | 600 | 300 | 180 | 0.13 | 0.15 | 315 |
| FAI46I0245K- | 2400 | 500 | 400 | 200 | 0.15 | 0.20 | 315 |
| FAI46J0185K- | 1800 | 550 | 450 | 230 | 0.35 | 0.38 | 315 |
| FAI46J0125K- | 1200 | 500 | 500 | 200 | 0.20 | 0.22 | 315 |
| FAI46J0664K- | 660 | 450 | 500 | 220 | 0.26 | 0.32 | 315 |
| FAI46K0334K- | 330 | 380 | 600 | 220 | 0.315 | 0.315 | 315 |
| FAI46K0284K- | 280 | 320 | 600 | 190 | 0.37 | 0.375 | 315 |

TUNING

FAI* RoHS Compliant

TUNING

110 nF 500 Vrms
FAI16J0114K--
FAI36J0114K--

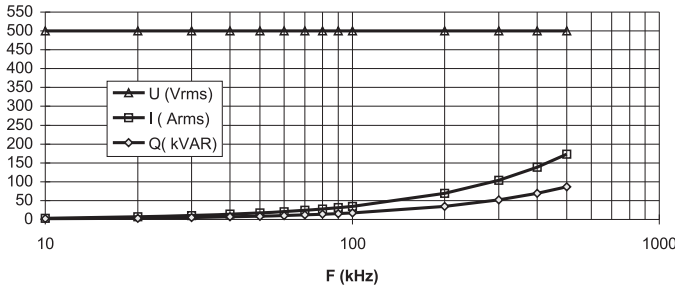

660 nF 500 Vrms
FAI16J0664K--
FAI36J0664K--

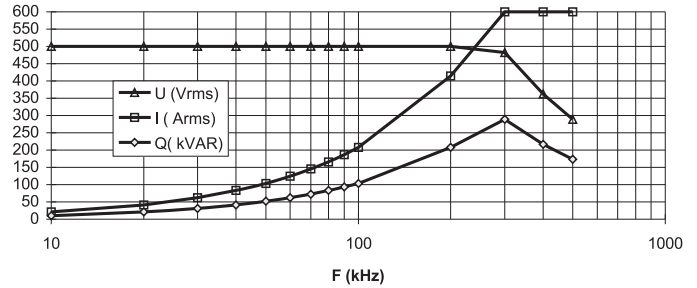

210 nF 500 Vrms
FAI16J0214K--

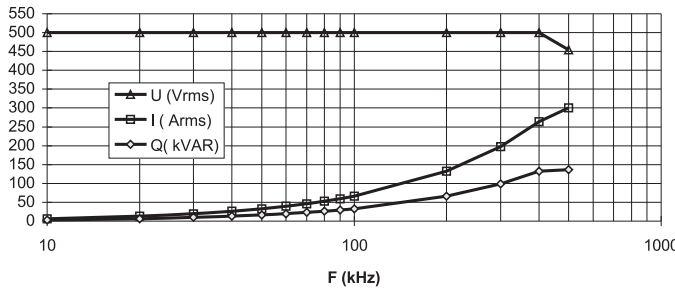

660 nF 500 Vrms
FAI26J0664K--

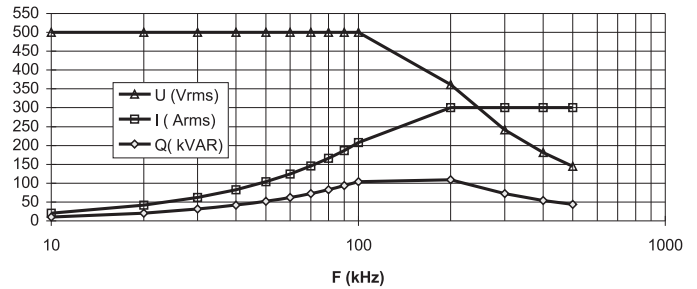

330 nF 500 Vrms
FAI16J0334K--
FAI36J0334K--

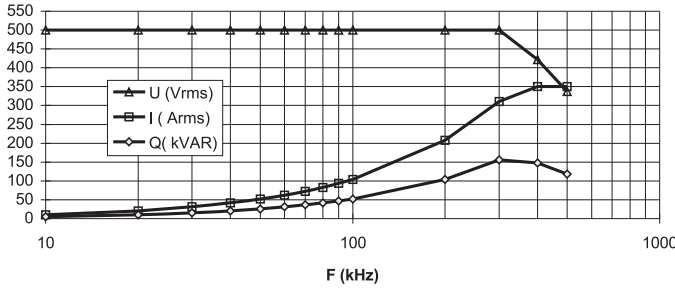

1200 nF 500 Vrms
FAI26J0125K--

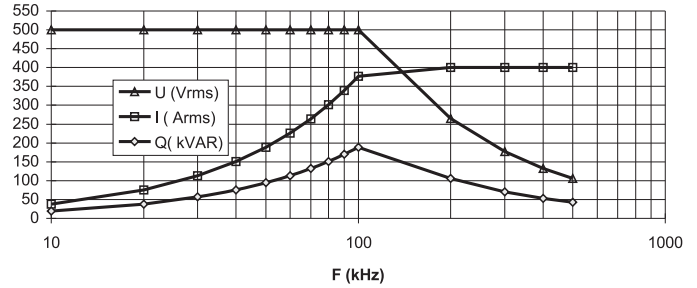

510 nF 500 Vrms
FAI16J0514K--
FAI36J0514K--

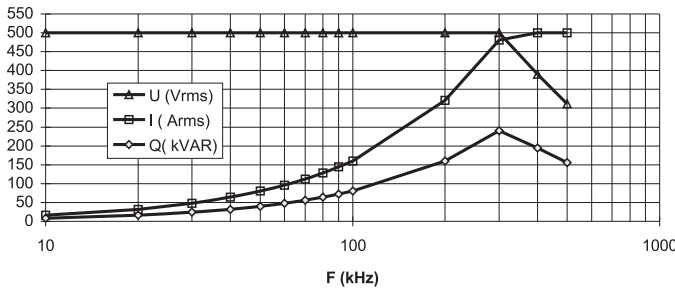

2400 nF 350 Vrms
FAI26J0245K--

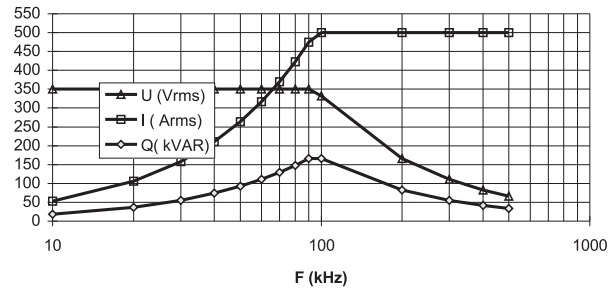

TUNING

FAI* RoHS Compliant

TUNING

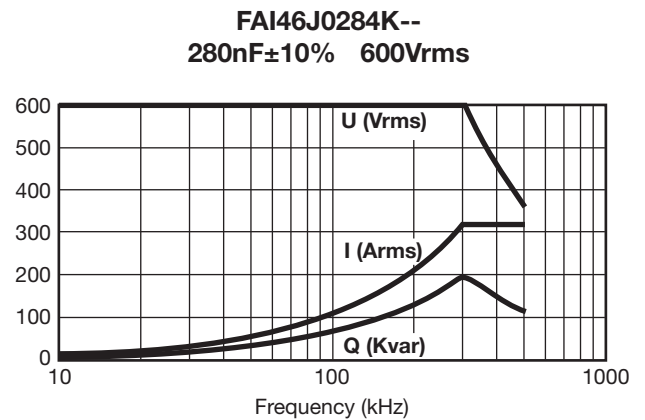
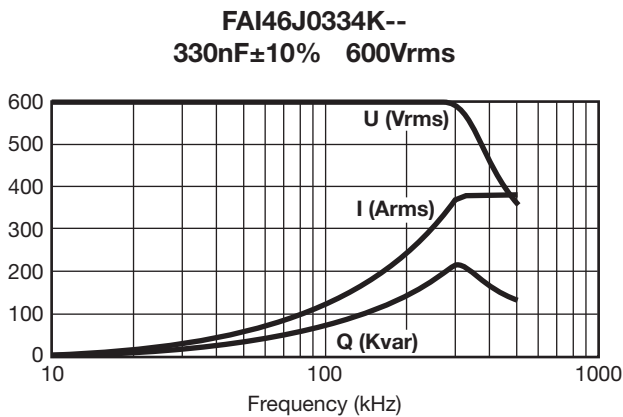
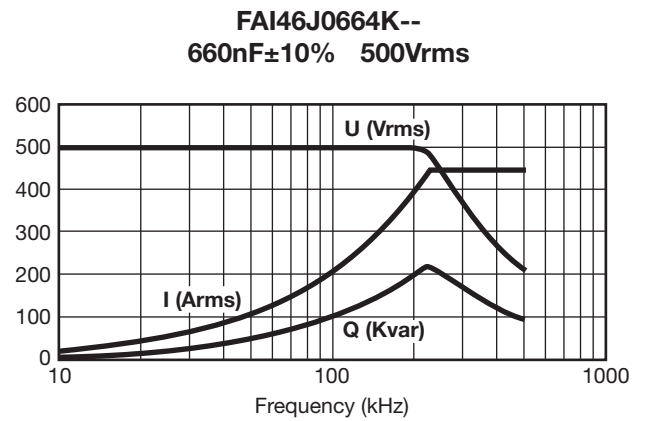
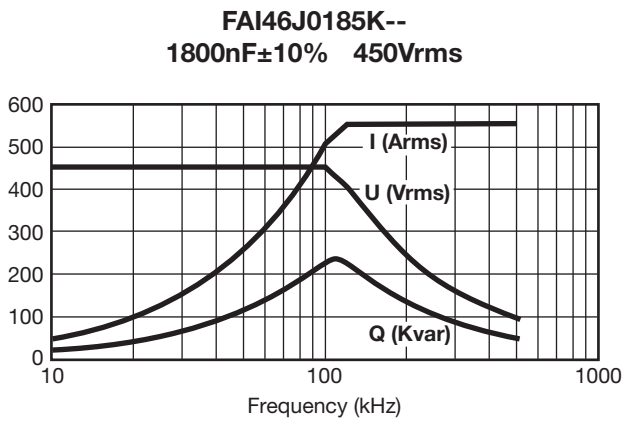
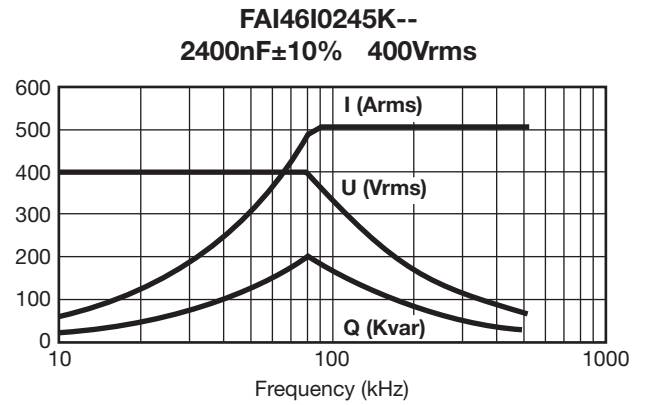
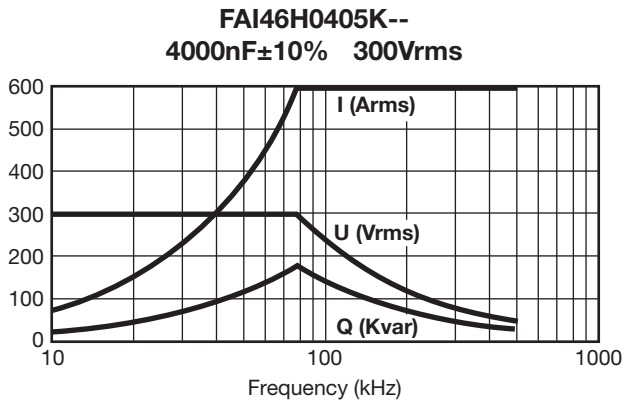

TUNING

FAI* RoHS Compliant

TUNING

FAI6

| Part Number | Width (mm) | Vrms max (V) | C (μF) | Qmax (kVAR) | Irms max (A) | Rs (mΩ) | Rth (°C/W) | Typical Weight (g) |
|--------------|------------|--------------|--------|-------------|--------------|--|------------|--------------------|
| FAI66F0156K- | 90 | 200 | 15 | 160 | 800 | $5.10^{-4} \times \sqrt{f(\text{Hz})} + 0.025$ | 0.104 | 1900 |
| FAI66H0126K- | | 300 | 12 | 240 | 800 | $5.10^{-4} \times \sqrt{f(\text{Hz})} + 0.03$ | 0.104 | 1900 |
| FAI66I0705K- | | 400 | 7 | 320 | 800 | $5.10^{-4} \times \sqrt{f(\text{Hz})} + 0.035$ | 0.114 | 1900 |
| FAI66J0505K- | | 500 | 5 | 320 | 640 | $5.10^{-4} \times \sqrt{f(\text{Hz})} + 0.04$ | 0.114 | 1900 |
| FAI66K0355K- | | 600 | 3.5 | 320 | 530 | $5.10^{-4} \times \sqrt{f(\text{Hz})} + 0.05$ | 0.124 | 1900 |
| FAI66A0155K- | | 650 | 1.5 | 320 | 490 | $5.10^{-4} \times \sqrt{f(\text{Hz})} + 0.07$ | 0.134 | 1900 |
| FAI66F0306K- | 190 | 200 | 30 | 240 | 1200 | $2.5.10^{-4} \times \sqrt{f(\text{Hz})} + 0.0125$ | 0.079 | 3950 |
| FAI66H0246K- | | 300 | 24 | 360 | 1200 | $2.5.10^{-4} \times \sqrt{f(\text{Hz})} + 0.015$ | 0.079 | 3950 |
| FAI66I0146K- | | 400 | 14 | 480 | 1200 | $2.5.10^{-4} \times \sqrt{f(\text{Hz})} + 0.0175$ | 0.084 | 3950 |
| FAI66J0106K- | | 500 | 10 | 600 | 1200 | $2.5.10^{-4} \times \sqrt{f(\text{Hz})} + 0.02$ | 0.084 | 3950 |
| FAI66K0705K- | | 600 | 7 | 640 | 1070 | $2.5.10^{-4} \times \sqrt{f(\text{Hz})} + 0.025$ | 0.089 | 3950 |
| FAI66A0305K- | | 650 | 3 | 640 | 985 | $2.5.10^{-4} \times \sqrt{f(\text{Hz})} + 0.035$ | 0.094 | 3950 |
| FAI66F0456K- | 290 | 200 | 45 | 320 | 1600 | $2.10^{-4} \times \sqrt{f(\text{Hz})} + 0.0083$ | 0.072 | 6100 |
| FAI66H0366K- | | 300 | 36 | 480 | 1600 | $2.10^{-4} \times \sqrt{f(\text{Hz})} + 0.01$ | 0.072 | 6100 |
| FAI66I0216K- | | 400 | 21 | 640 | 1600 | $2.10^{-4} \times \sqrt{f(\text{Hz})} + 0.0117$ | 0.075 | 6100 |
| FAI66J0156K- | | 500 | 15 | 800 | 1600 | $2.10^{-4} \times \sqrt{f(\text{Hz})} + 0.0133$ | 0.075 | 6100 |
| FAI66K1055K- | | 600 | 10.5 | 960 | 1600 | $2.10^{-4} \times \sqrt{f(\text{Hz})} + 0.0167$ | 0.078 | 6100 |
| FAI66A0455K- | | 650 | 4.5 | 960 | 1480 | $2.10^{-4} \times \sqrt{f(\text{Hz})} + 0.0233$ | 0.082 | 6100 |
| FAI66F0606K- | 390 | 200 | 60 | 400 | 2000 | $1.5.10^{-4} \times \sqrt{f(\text{Hz})} + 0.00625$ | 0.067 | 8200 |
| FAI66H0486K- | | 300 | 48 | 600 | 2000 | $1.5.10^{-4} \times \sqrt{f(\text{Hz})} + 0.0075$ | 0.067 | 8200 |
| FAI66I0286K- | | 400 | 28 | 800 | 2000 | $1.5.10^{-4} \times \sqrt{f(\text{Hz})} + 0.00875$ | 0.070 | 8200 |
| FAI66J0206K- | | 500 | 20 | 1000 | 2000 | $1.5.10^{-4} \times \sqrt{f(\text{Hz})} + 0.01$ | 0.070 | 8200 |
| FAI66K0146K- | | 600 | 14 | 1200 | 2000 | $1.5.10^{-4} \times \sqrt{f(\text{Hz})} + 0.0125$ | 0.072 | 8200 |
| FAI66A0605K- | | 650 | 6 | 1280 | 1970 | $1.5.10^{-4} \times \sqrt{f(\text{Hz})} + 0.0175$ | 0.075 | 8200 |

TUNING

CASE SIZE 6 DIMENSIONS

FAI6 WIDTH: 90 (3.543)

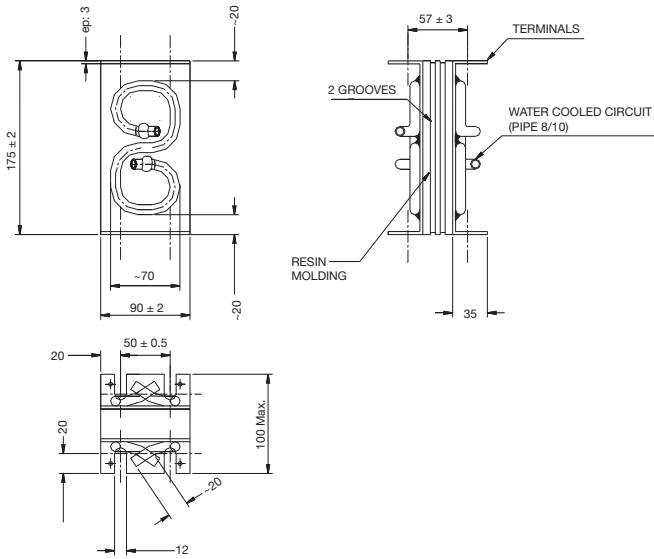

FAI6 WIDTH: 290 (11.417)

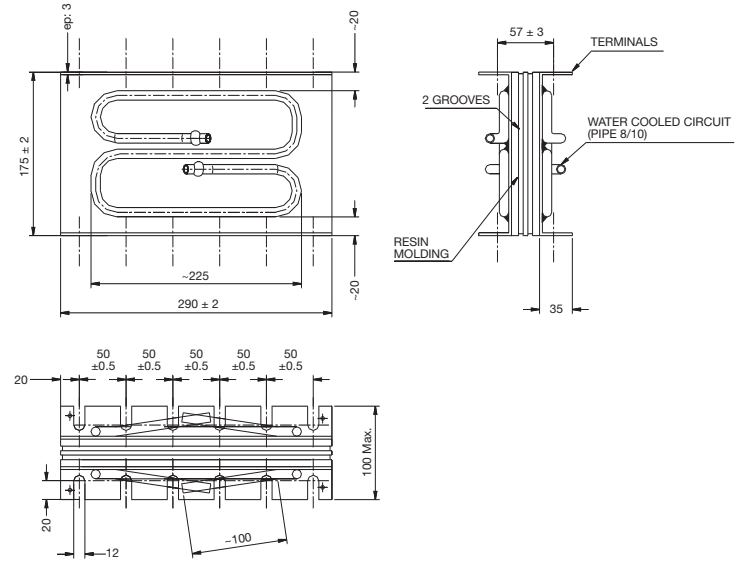

FAI6 WIDTH: 190 (7.480)

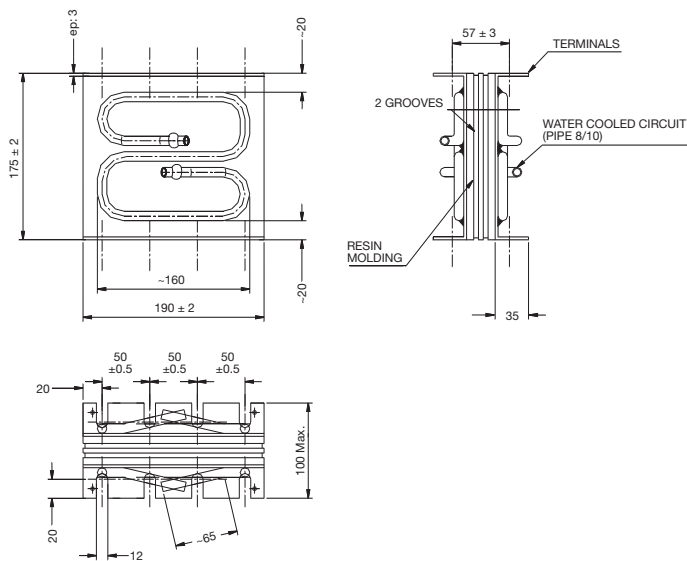

FAI6 WIDTH: 390 (15.354)

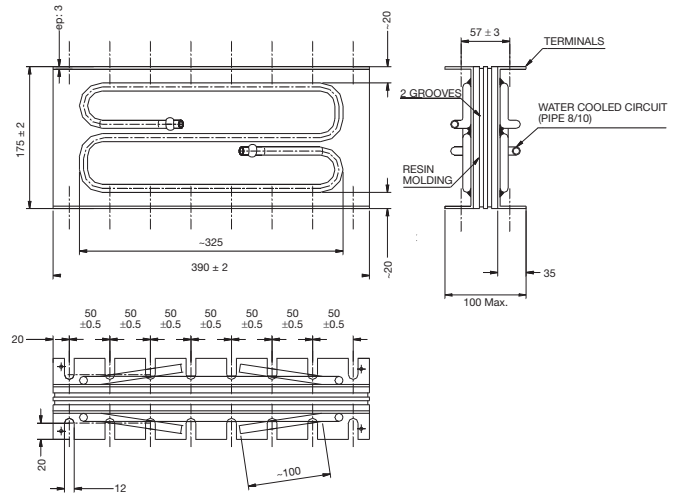

TUNING

FAI* RoHS Compliant

TUNING

15 μ F 200 Vrms Width 90 mm
FAI66F0156K--

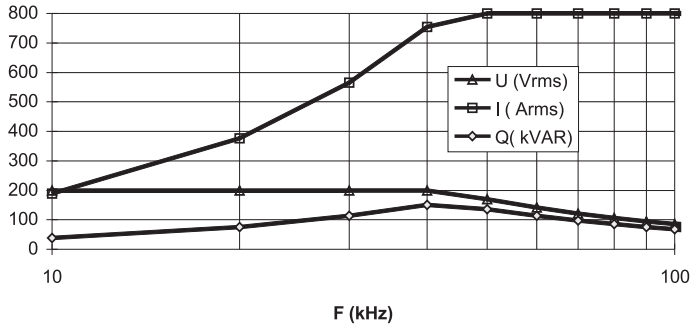

12 μ F 300 Vrms Width 90 mm
FAI66H0126K--

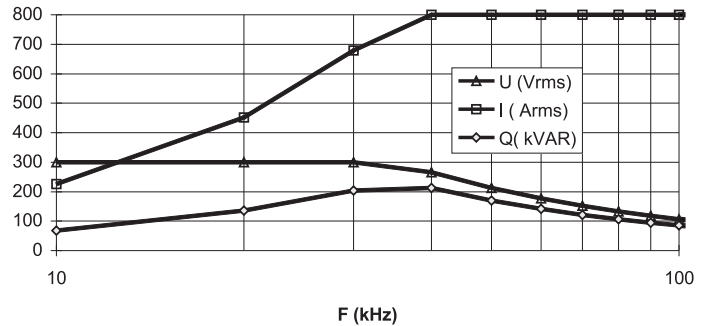

30 μ F 200 Vrms Width 190 mm
FAI66F0306K--

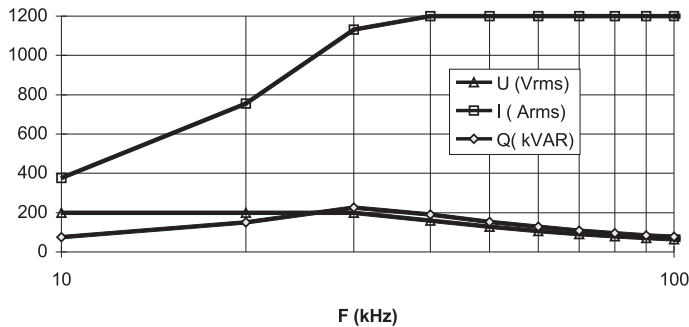

24 μ F 300 Vrms Width 190 mm
FAI66H0246K--

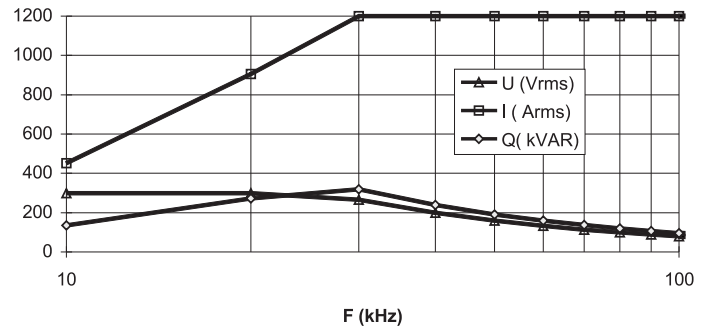

45 μ F 200 Vrms Width 290 mm
FAI66F0456K--

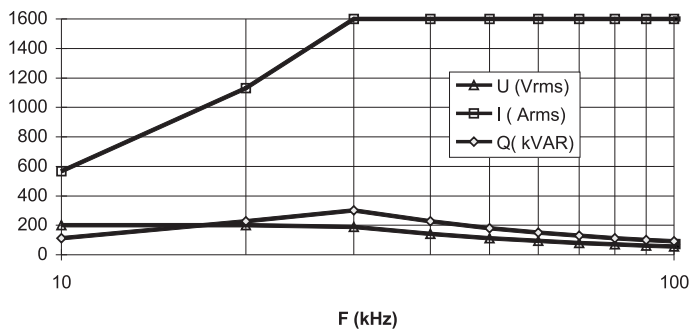

36 μ F 300 Vrms Width 290 mm
FAI66H0366K--

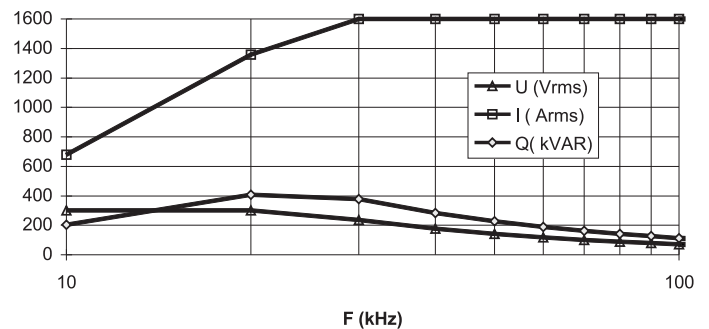

60 μ F 200 Vrms Width 390 mm
FAI66F0606K--

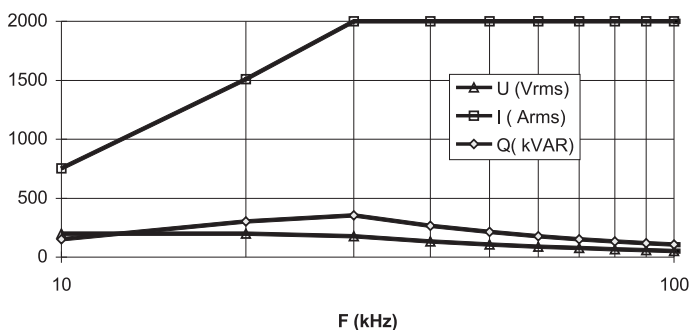

48 μ F 300 Vrms Width 390 mm
FAI66H0486K--

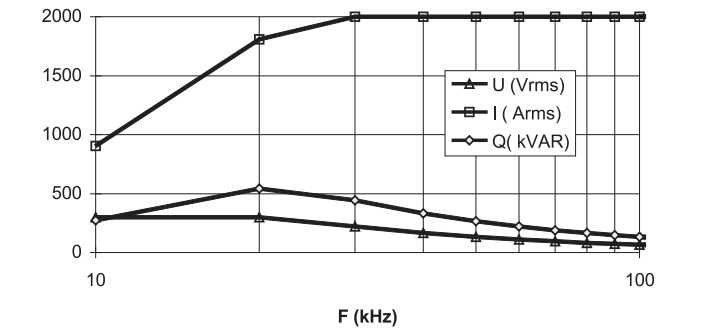

TUNING

FAI* RoHS Compliant

TUNING

7 μ F 400 Vrms Width 90 mm
FAI66I0705K--

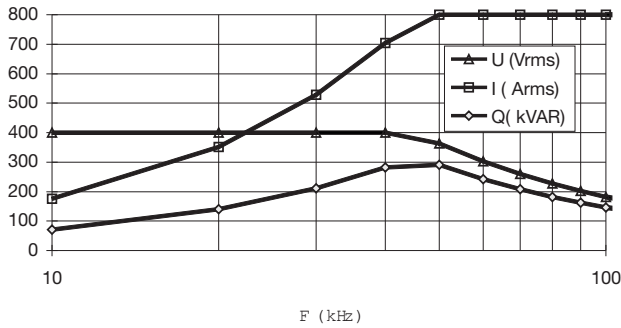

5 μ F 500 Vrms Width 90 mm
FAI66J0505K--

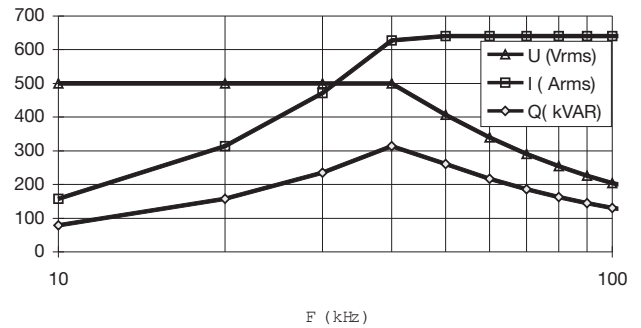

14 μ F 400 Vrms Width 190 mm
FAI66I0146K--

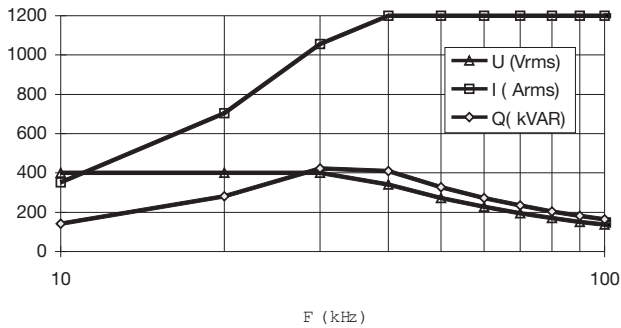

10 μ F 500 Vrms Width 190 mm
FAI66J0106K--

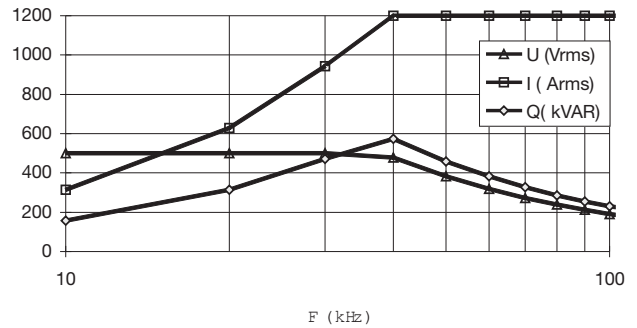

21 μ F 400 Vrms Width 290 mm
FAI66I0216K--

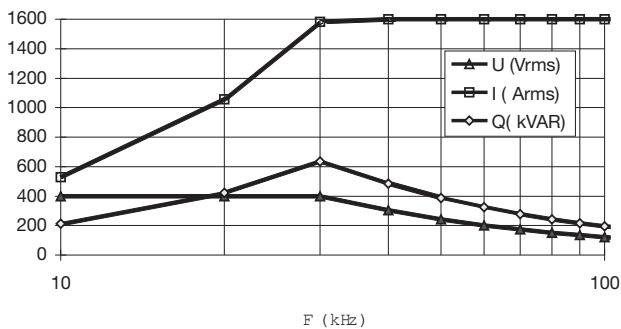

15 μ F 500 Vrms Width 290 mm
FAI66J0156K--

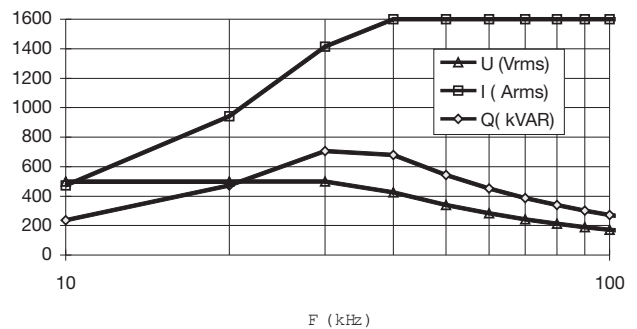

28 μ F 400 Vrms Width 390 mm
FAI66I0286K--

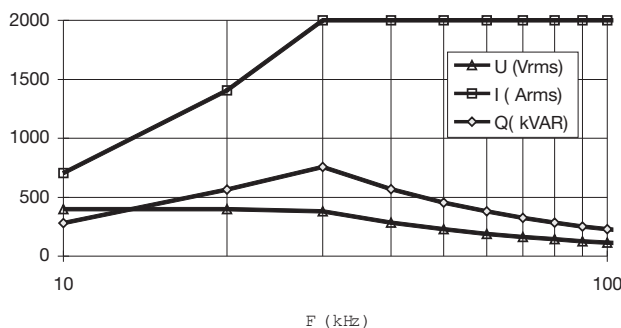

20 μ F 500 Vrms Width 390 mm
FAI66J0206K--

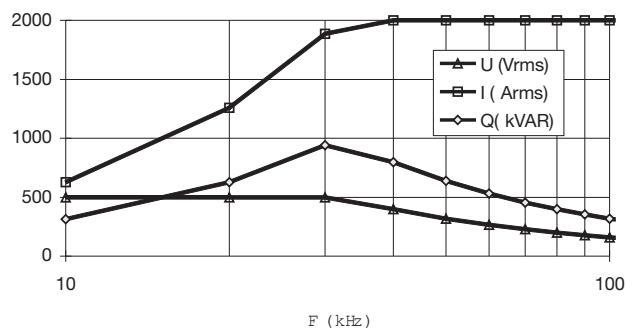

TUNING

FAI* RoHS Compliant

TUNING

**3.5 μ F 600 Vrms Width 90 mm
FAI66K0355K--**

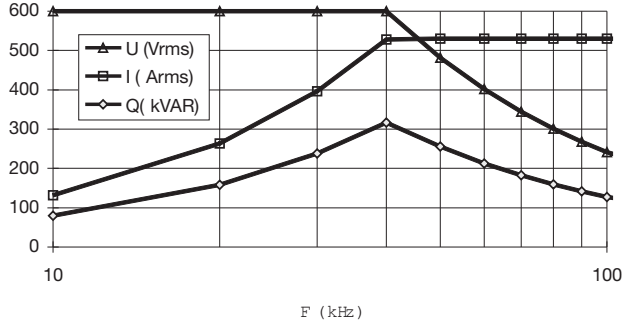

**1.5 μ F 650 Vrms Width 90 mm
FAI66A0155K--**

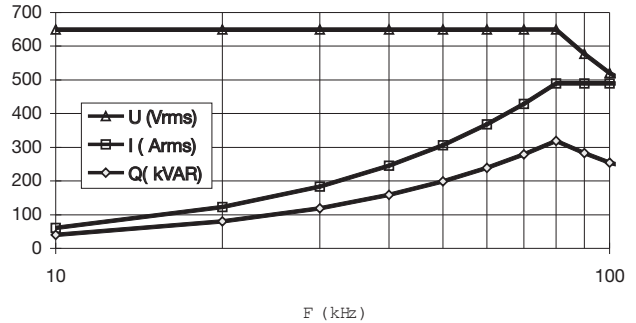

**7 μ F 600 Vrms Width 190 mm
FAI66K0705K--**

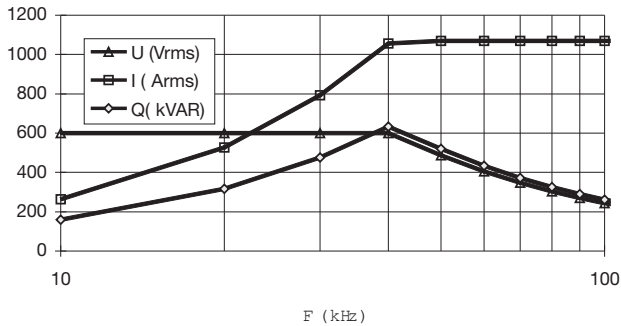

**3 μ F 650 Vrms Width 190 mm
FAI66A0305K--**

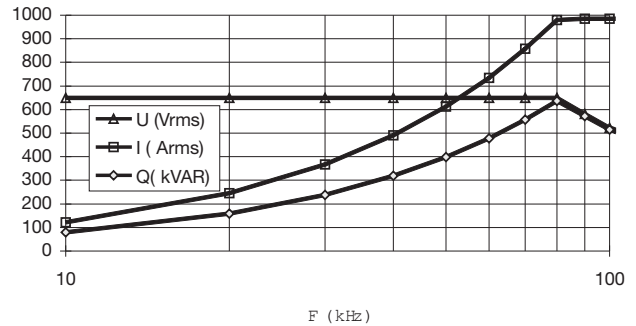

**10.5 μ F 600 Vrms Width 290 mm
FAI66K1055K--**

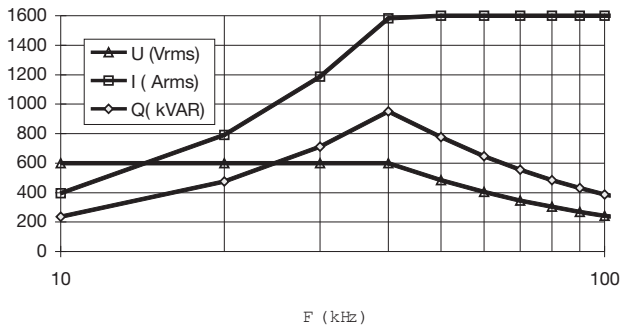

**4.5 μ F 650 Vrms Width 290 mm
FAI66A0455K--**

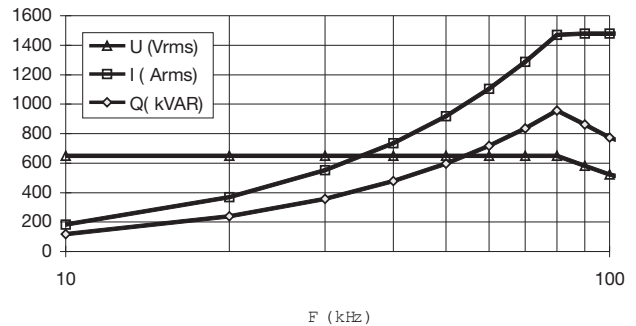

**14 μ F 600 Vrms Width 390 mm
FAI66K0146K--**

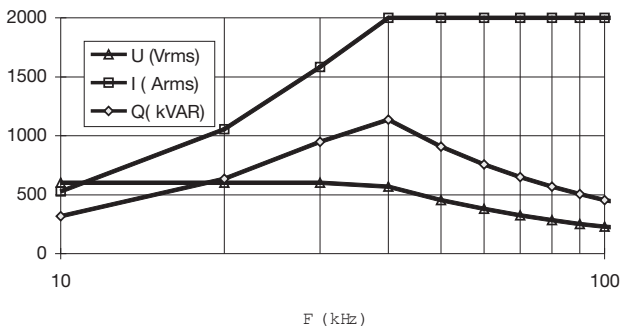

**6 μ F 650 Vrms Width 390 mm
FAI66A0605K--**

