

F93 Series



Resin-Molded Chip, Standard Tantalum J-Lead



FEATURES

- Compliant to the RoHS2 directive 2011/65/EU
- SMD J-lead

APPLICATIONS

- Low power DC/DC



CASE DIMENSIONS: millimeters (inches)

Code	EIA Code	EIA Metric	L	W ₁	W ₂	H	S
A	1206	3216-18	3.20 ± 0.20 (0.126 ± 0.008)	1.60 ± 0.20 (0.063 ± 0.008)	1.20 ± 0.10 (0.047 ± 0.004)	1.60 ± 0.20 (0.063 ± 0.008)	0.80 ± 0.20 (0.031 ± 0.008)
B	1210	3528-21	3.50 ± 0.20 (0.138 ± 0.008)	2.80 ± 0.20 (0.110 ± 0.008)	2.20 ± 0.10 (0.087 ± 0.004)	1.90 ± 0.20 (0.075 ± 0.008)	0.80 ± 0.20 (0.031 ± 0.008)
C	2312	6032-27	6.00 ± 0.20 (0.236 ± 0.008)	3.20 ± 0.20 (0.126 ± 0.008)	2.20 ± 0.10 (0.087 ± 0.004)	2.50 ± 0.20 (0.098 ± 0.008)	1.30 ± 0.20 (0.051 ± 0.008)
N	2917	7343-30	7.30 ± 0.20 (0.287 ± 0.008)	4.30 ± 0.20 (0.169 ± 0.008)	2.40 ± 0.10 (0.094 ± 0.004)	2.80 ± 0.20 (0.110 ± 0.008)	1.30 ± 0.20 (0.051 ± 0.008)

A, B CASE

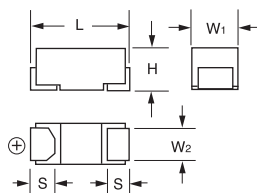

C, N CASE

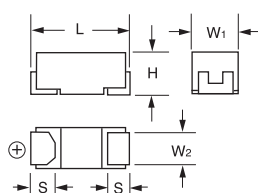

MARKING

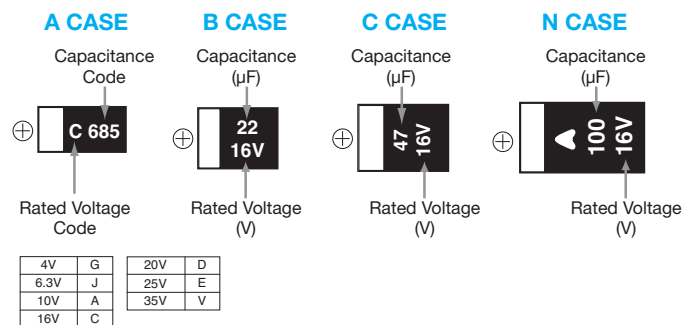

HOW TO ORDER

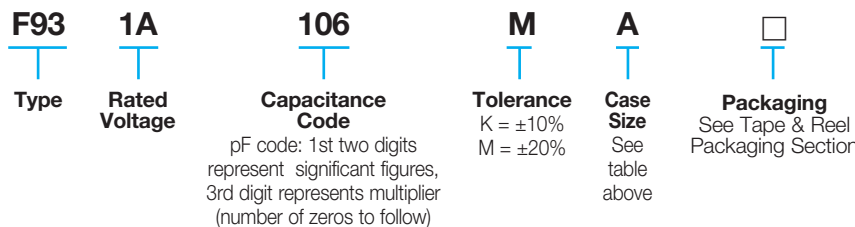

TECHNICAL SPECIFICATIONS

Category Temperature Range:	-55 to +125°C
Rated Temperature:	+85°C
Capacitance Tolerance:	±20%, ±10% at 120Hz
Dissipation Factor:	Refer to next page
ESR 100kHz:	Refer to next page
Leakage Current:	After 1 minute's application of rated voltage, leakage current at 20°C is not more than 0.01CV or 0.5µA, whichever is greater. After 1 minute's application of rated voltage, leakage current at 85°C is not more than 0.1CV or 5µA, whichever is greater. After 1 minute's application of derated voltage, leakage current at 125°C is not more than 0.125CV or 6.3µA, whichever is greater.
Capacitance Change By Temperature	+15% Max. at +125°C +10% Max. at +85°C -10% Max. at -55°C



F93 Series



Resin-Molded Chip, Standard Tantalum J-Lead

CAPACITANCE AND RATED VOLTAGE RANGE (LETTER DENOTES CASE SIZE)

Capacitance		Rated Voltage						
µF	Code	4V (0G)	6.3V (0J)	10V (1A)	16V (1C)	20V (1D)	25V (1E)	35V (1V)
0.33	334							A
0.47	474							A
0.68	684							A
1.0	105				A		A	A
1.5	155				A		A	A
2.2	225				A	A	A	A/B
3.3	335				A	A	A	B
4.7	475			A	A	A/B	A/B	B/C
6.8	685			A	A	A/B		C
10	106		A	A	A/B	A/B	B/C	C
15	156		A	A	A/B	C	C	N
22	226	A	A	A/B	A/B/C	B/C	C/N	N
33	336	A	A	A/B	B/C	C/N	N	N
47	476	A	A/B	A/B/C	B/C/N	C/N	N	
68	686	A	A/B	B/C	C/N			
100	107	A/B	A/B/C	B/C/N	C/N			
150	157	B	B/C	C/N	N			
220	227	B/C	B/C/N	C/N	N			
330	337	C	N	N				
470	477	N	N					
680	687	N	N					

Released ratings

Please contact to your local AVX sales office when these series are being designed in your application.

RATINGS & PART NUMBER REFERENCE

AVX Part No.	Case Size	Capacitance (µF)	Rated Voltage (V)	DCL (µA)	DF @ 120Hz (%)	ESR @ 100kHz (Ω)	100kHz RMS Current (mA)			*1 ΔC/C (%)	MSL
							25°C	85°C	125°C		
4 Volt											
F930G226#AA	A	22	4	0.9	6	2.5	173	156	69	*	1
F930G336#AA	A	33	4	1.3	8	2.5	173	156	69	*	1
F930G476#AA	A	47	4	1.9	18	2.5	173	156	69	*	1
F930G686#AA	A	68	4	2.7	24	2.5	173	156	69	*	1
F930G107#AA	A	100	4	4.0	30	2.0	194	174	77	*	1
F930G107#BA	B	100	4	4.0	14	0.9	307	277	123	*	1
F930G157#BA	B	150	4	6.0	16	0.7	348	314	139	*	1
F930G227#BA	B	220	4	8.8	18	0.7	348	314	139	*	1
F930G227#CC	C	220	4	8.8	12	0.7	396	357	159	*	1
F930G337#CC	C	330	4	13.2	14	0.7	396	357	159	*	1
F930G477#NC	N	470	4	18.8	16	0.3	707	636	283	*	1
F930G687#NC	N	680	4	27.2	18	0.3	707	636	283	*	1
6.3 Volt											
F930J106#AA	A	10	6.3	0.6	6	3.0	158	142	63	*	1
F930J156#AA	A	15	6.3	0.9	6	2.9	161	145	64	*	1
F930J226#AA	A	22	6.3	1.4	8	2.5	173	156	69	*	1
F930J336#AA	A	33	6.3	2.1	8	2.5	173	156	69	*	1
F930J476#AA	A	47	6.3	3.0	18	2.5	173	156	69	*	1
F930J476#BA	B	47	6.3	3.0	6	1.0	292	262	117	*	1
F930J686#AA	A	68	6.3	4.3	20	2.0	194	174	77	*	1
F930J686#BA	B	68	6.3	4.3	8	1.0	292	262	117	*	1
F930J107#AA	A	100	6.3	6.3	35	2.0	194	174	77	±15	1
F930J107#BA	B	100	6.3	6.3	14	0.9	307	277	123	*	1
F930J107#CC	C	100	6.3	6.3	8	0.7	396	357	159	*	1
F930J157#BA	B	150	6.3	9.5	18	0.9	307	277	123	*	1
F930J157#CC	C	150	6.3	9.5	12	0.7	396	357	159	*	1
F930J227#BA	B	220	6.3	13.9	30	1.2	266	240	106	±15	3
F930J227#CC	C	220	6.3	13.9	14	0.7	396	357	159	*	1
F930J227#NC	N	220	6.3	13.9	10	0.5	548	493	219	*	1
F930J337#NC	N	330	6.3	20.8	14	0.5	548	493	219	*	1
F930J477#NC	N	470	6.3	29.6	16	0.3	707	636	283	*	1
F930J687#NC	N	680	6.3	42.8	40	0.3	707	636	283	±15	3

F93 Series



Resin-Molded Chip, Standard Tantalum J-Lead

RATINGS & PART NUMBER REFERENCE

AVX Part No.	Case Size	Capacitance (μF)	Rated Voltage (V)	DCL (μA)	DF @ 120Hz (%)	ESR @ 100kHz (Ω)	100kHz RMS Current (mA)			*1 ΔC/C (%)	MSL
							25°C	85°C	125°C		
10 Volt											
F931A475#AA	A	4.7	10	0.5	6	4.0	137	123	55	*	1
F931A685#AA	A	6.8	10	0.7	6	3.5	146	132	59	*	1
F931A106#AA	A	10	10	1.0	6	3.0	158	142	63	*	1
F931A156#AA	A	15	10	1.5	8	2.9	161	145	64	*	1
F931A226#AA	A	22	10	2.2	12	2.5	173	156	69	*	1
F931A226#BA	B	22	10	2.2	6	1.9	212	190	85	*	1
F931A336#AA	A	33	10	3.3	18	2.5	173	156	69	*	1
F931A336#BA	B	33	10	3.3	8	1.4	246	222	99	*	1
F931A476#AA	A	47	10	4.7	40	2.0	194	174	77	±15	1
F931A476#BA	B	47	10	4.7	8	1.0	292	262	117	*	1
F931A476#CC	C	47	10	4.7	6	0.9	350	315	140	*	1
F931A686#BA	B	68	10	6.8	12	0.9	307	277	123	±15	1
F931A686#CC	C	68	10	6.8	8	0.8	371	334	148	*	1
F931A107#BA	B	100	10	10.0	18	1.2	266	240	106	±15	1
F931A107#CC	C	100	10	10.0	10	0.7	396	357	159	*	1
F931A107#NC	N	100	10	10.0	8	0.6	500	450	200	*	3
F931A157#CC	C	150	10	15.0	14	0.7	396	357	159	*	1
F931A157#NC	N	150	10	15.0	10	0.6	500	450	200	*	1
F931A227#CC	C	220	10	22.0	40	0.9	350	315	140	±15	1
F931A227#NC	N	220	10	22.0	12	0.5	548	493	219	*	3
F931A337#NC	N	330	10	33.0	18	0.5	548	493	219	*	1
16 Volt											
F931C105#AA	A	1	16	0.5	4	7.5	100	90	40	*	1
F931C155#AA	A	1.5	16	0.5	4	6.0	112	101	45	*	1
F931C225#AA	A	2.2	16	0.5	4	5.0	122	110	49	*	1
F931C335#AA	A	3.3	16	0.5	4	4.5	129	116	52	*	1
F931C475#AA	A	4.7	16	0.8	6	4.0	137	123	55	*	1
F931C685#AA	A	6.8	16	1.1	6	3.5	146	132	59	*	1
F931C106#AA	A	10	16	1.6	6	3.0	158	142	63	*	1
F931C106#BA	B	10	16	1.6	6	2.0	206	186	82	*	1
F931C156#AA	A	15	16	2.4	10	3.0	158	142	63	*	1
F931C156#BA	B	15	16	2.4	6	2.0	206	186	82	*	1
F931C226#AA	A	22	16	3.5	15	3.0	158	142	63	±15	1
F931C226#BA	B	22	16	3.5	8	1.9	212	190	85	*	1
F931C226#CC	C	22	16	3.5	6	1.1	316	285	126	*	1
F931C336#BA	B	33	16	5.3	8	1.9	212	190	85	*	1
F931C336#CC	C	33	16	5.3	6	1.1	316	285	126	*	1
F931C476#BA	B	47	16	7.5	16	2.0	206	186	82	±15	1
F931C476#CC	C	47	16	7.5	8	0.9	350	315	140	*	1
F931C476#NC	N	47	16	7.5	6	0.7	463	417	185	*	1
F931C686#CC	C	68	16	10.9	10	0.8	371	334	148	±10	1
F931C686#NC	N	68	16	10.9	6	0.6	500	450	200	*	1
F931C107#CC	C	100	16	16.0	15	0.7	396	357	159	±10	1
F931C107#NC	N	100	16	16.0	10	0.6	500	450	200	*	3
F931C157#NC	N	150	16	24.0	15	0.6	500	450	200	*	1
F931C227#NC	N	220	16	35.2	25	0.7	463	417	185	±10	3
20 Volt											
F931D225#AA	A	2.2	20	0.5	4	5.0	122	110	49	*	1
F931D335#AA	A	3.3	20	0.7	4	4.5	129	116	52	*	1
F931D475#AA	A	4.7	20	0.9	6	3.0	158	142	63	*	1
F931D475#BA	B	4.7	20	0.9	6	2.8	174	157	70	*	1
F931D685#AA	A	6.8	20	1.4	6	3.5	146	132	59	*	1
F931D685#BA	B	6.8	20	1.4	6	2.5	184	166	74	*	1
F931D106#AA	A	10	20	2.0	8	3.5	146	132	59	*	1
F931D106#BA	B	10	20	2.0	6	2.1	201	181	80	*	1
F931D156#CC	C	15	20	3.0	6	1.2	303	272	121	*	1
F931D226#BA	B	22	20	4.4	8	1.9	212	190	85	*	1
F931D226#CC	C	22	20	4.4	8	1.1	316	285	126	*	1
F931D336#CC	C	33	20	6.6	8	1.1	316	285	126	*	1
F931D336#NC	N	33	20	6.6	6	0.7	463	417	185	*	1
F931D476#CC	C	47	20	9.4	10	1.1	316	285	126	*	1
F931D476#NC	N	47	20	9.4	8	0.7	463	417	185	*	1
25 Volt											
F931E105#AA	A	1	25	0.5	4	7.5	100	90	40	*	1
F931E155#AA	A	1.5	25	0.5	4	6.7	106	95	42	*	1
F931E225#AA	A	2.2	25	0.6	6	6.3	109	98	44	*	1
F931E335#AA	A	3.3	25	0.8	6	6.0	112	101	45	*	1
F931E475#AA	A	4.7	25	1.2	8	4.0	137	123	55	*	1
F931E475#BA	B	4.7	25	1.2	6	2.8	174	157	70	*	1
F931E106#BA	B	10	25	2.5	12	1.9	212	190	85	*	1
F931E106#CC	C	10	25	2.5	6	1.5	271	244	108	*	1
F931E156#CC	C	15	25	3.8	8	1.2	303	272	121	*	1
F931E226#CC	C	22	25	5.5	8	1.1	316	285	126	*	1

F93 Series



Resin-Molded Chip, Standard Tantalum J-Lead

RATINGS & PART NUMBER REFERENCE

AVX Part No.	Case Size	Capacitance (μF)	Rated Voltage (V)	DCL (μA)	DF @ 120Hz (%)	ESR @ 100kHz (Ω)	100kHz RMS Current (mA)			*1 ΔC/C (%)	MSL
							25°C	85°C	125°C		
F931E226#NC	N	22	25	5.5	6	0.7	463	417	185	*	1
F931E336#NC	N	33	25	8.3	8	0.7	463	417	185	*	1
F931E476#NC	N	47	25	11.8	8	0.7	463	417	185	*	1
35 Volt											
F931V334#AA	A	0.33	35	0.5	4	12.0	79	71	32	*	1
F931V474#AA	A	0.47	35	0.5	4	10.0	87	78	35	*	1
F931V684#AA	A	0.68	35	0.5	4	7.6	99	89	40	*	1
F931V105#AA	A	1	35	0.5	4	7.5	100	90	40	*	1
F931V155#AA	A	1.5	35	0.5	6	7.5	100	90	40	*	1
F931V225#AA	A	2.2	35	0.8	6	7.0	104	93	41	*	1
F931V225#BA	B	2.2	35	0.8	4	3.8	150	135	60	*	1
F931V335#BA	B	3.3	35	1.2	4	3.5	156	140	62	*	1
F931V475#BA	B	4.7	35	1.6	8	3.1	166	149	66	*	1
F931V475#CC	C	4.7	35	1.6	6	1.8	247	222	99	*	1
F931V685#CC	C	6.8	35	2.4	6	1.8	247	222	99	*	1
F931V106#CC	C	10	35	3.5	6	1.6	262	236	105	*	1
F931V156#NC	N	15	35	5.3	6	0.7	463	417	185	*	1
F931V226#NC	N	22	35	7.7	8	0.7	463	417	185	*	1
F931V336#NC	N	33	35	11.6	8	0.7	463	417	185	*	1

1: ΔC/C Marked “”

#: “M” for ±20% tolerance, “K” for ± 10% tolerance.

Moisture Sensitivity Level (MSL) is defined according to J-STD-020.

Item	All Case (%)
Damp Heat	±10
Temperature cycles	±5
Resistance soldering heat	±5
Surge	±5
Endurance	±10

QUALIFICATION TABLE

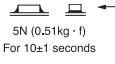
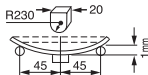
TEST	F93 series (Temperature range -55°C to +125°C)	
	Condition	
Damp Heat (Steady State)	At 40°C, 90 to 95% R.H., 500 hours (No voltage applied) Capacitance Change Refer to page 33 (*1) Dissipation Factor Initial specified value or less Leakage Current Initial specified value or less	
Temperature Cycles	-55°C / +125°C, 30 minutes each, 5 cycles Capacitance Change Refer to page 33 (*1) Dissipation Factor Initial specified value or less Leakage Current Initial specified value or less	
Resistance to Soldering Heat	10 seconds reflow at 260°C, 5 seconds immersion at 260°C. Capacitance Change Refer to page 33 (*1) Dissipation Factor Initial specified value or less Leakage Current Initial specified value or less	
Surge	After application of surge voltage in series with a 33Ω resistor at the rate of 30 seconds ON, 30 seconds OFF, for 1000 successive test cycles at 85°C, capacitors shall meet the characteristic requirements in the table above. Capacitance Change Refer to page 33 (*1) Dissipation Factor Initial specified value or less Leakage Current Initial specified value or less	
Endurance	After 2000 hours' application of rated voltage in series with a 3Ω resistor at 85°C, or derated voltage in series with a 3Ω resistor at 125°C, capacitors shall meet the characteristic requirements in the table above. Capacitance Change Refer to page 33 (*1) Dissipation Factor Initial specified value or less Leakage Current Initial specified value or less	
Shear Test	After applying the pressure load of 5N for 10±1 seconds horizontally to the center of capacitor side body which has no electrode and has been soldered beforehand on a substrate, there shall be found neither exfoliation nor its sign at the terminal electrode. 	
Terminal Strength	Keeping a capacitor surface-mounted on a substrate upside down and supporting the substrate at both of the opposite bottom points 45mm apart from the center of capacitor, the pressure strength is applied with a specified jig at the center of substrate so that the substrate may bend by 1mm as illustrated. Then, there shall be found no remarkable abnormality on the capacitor terminals. 	
Failure Rate	1% per 1000 hours at 85°C, VR with 0.1Ω/V series impedance, 60% confidence level.	

We can supply the type of compliance to AEC-Q200. Please contact to your local AVX sales office when these series are being designed in your application.

AVX SOLID ELECTROLYTE CAPACITOR ROADMAP

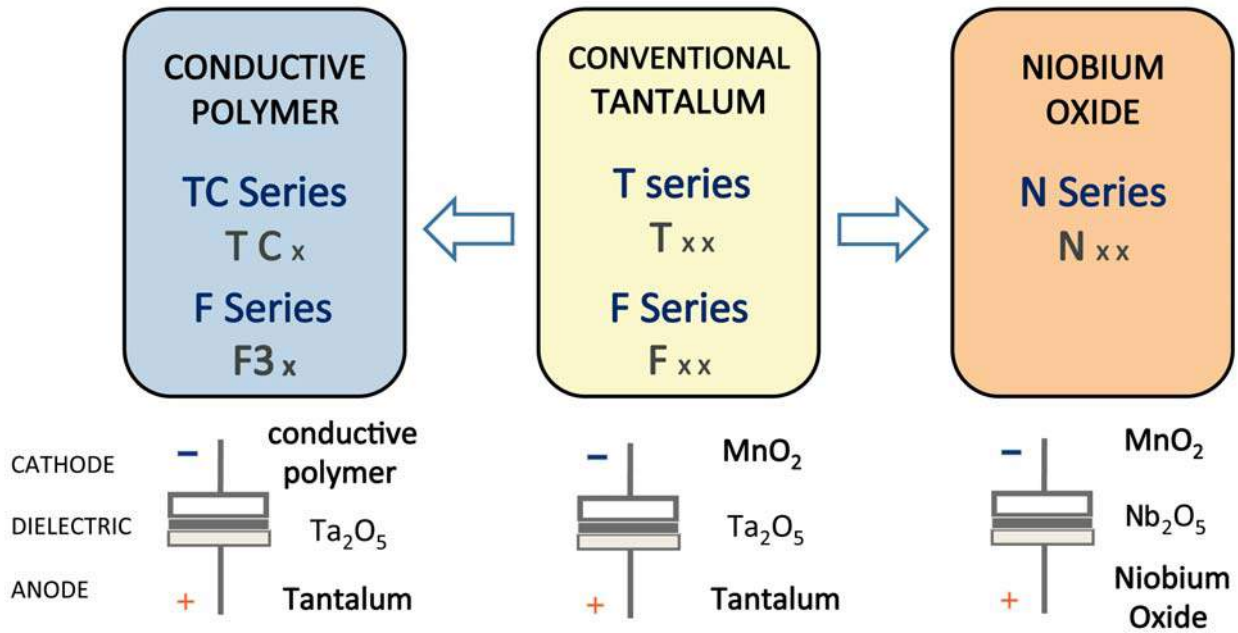

Five Capacitor Construction Styles

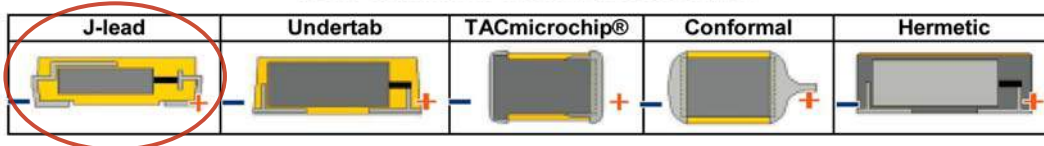

SERIES LINE UP: CONVENTIONAL SMD MnO₂

