

ARTESYN ERM 10W SERIES

DC/DC Converter



PRODUCT DESCRIPTION

Advanced Energy's Artesyn ERM 10W series is a new range of high performance 10W isolated dc-dc converter within encapsulated 2"x1" package which specifically design for railway applications. There are 18 models available for railway input voltage of either 24 (9~36) Vdc or 48 (18~75) Vdc or 72/110 (40~160) Vdc and tight output voltage regulation. Further features include over current, over voltage, short circuit protection, remote ON/OFF, output trim and EMI filter meets EN55032/22 & FCC Part15 Class A as well.

SPECIAL FEATURES

- Industrial Standard 2"x1" Package
- Ultra-wide Input Voltage Range
- Fully Regulated Output Voltage
- I/O Isolation 3000Vac with Reinforced Insulation
- Operating Temp. Range -40 °C to +95°C
- No Minimum Load Requirement
- Overload Voltage and Short Circuit Protection
- Designed-in Conducted EMI meets EN55032/22 Class A & FCC Level A
- Vibration and Shock meets EN61373
- Cooling, Dry & Damp Heat Test meet IEC/EN60068-2-1,2,30
- Fire Protection Test meets EN45545-2
- Railway EMC Standard meets EN50121-3-2

SAFETY

- UL/cUL/IEC/EN62368-1 (60950-1)
- CE Mark
- Railway Certified meets EN50155 (IEC60571)

AT A GLANCE

Total Power

10 Watts

Input Voltage

9 to 36 Vdc

18 to 75 Vdc

40 to 160 Vdc

of Outputs

Single / Dual



RoHS

MODEL NUMBERS

Model	Input Voltage	Output Voltage	Maximum Load	Efficiency
ERM02A18	9-36Vdc	5Vdc	2.0A	84%
ERM00B18	9-36Vdc	12Vdc	0.835A	86%
ERM00C18	9-36Vdc	15Vdc	0.67A	87%
ERM00H18	9-36Vdc	24Vdc	0.417A	88%
ERM00BB18	9-36Vdc	±12Vdc	0.417A	86%
ERM00CC18	9-36Vdc	±15Vdc	0.335A	87%
ERM02A18B ¹	9-36Vdc	5Vdc	2.0A	84%
ERM00B18B	9-36Vdc	12Vdc	0.835A	86%
ERM00C18B	9-36Vdc	15Vdc	0.67A	87%
ERM00H18B	9-36Vdc	24Vdc	0.417A	88%
ERM00BB18B	9-36Vdc	±12Vdc	0.417A	86%
ERM00CC18B	9-36Vdc	±15Vdc	0.335A	87%
ERM02A36	18-75Vdc	5Vdc	2.0A	85%
ERM00B36	18-75Vdc	12Vdc	0.83A	87%
ERM00C36	18-75Vdc	15Vdc	0.67A	87%
ERM00H36	18-75Vdc	24Vdc	0.417A	86%
ERM00BB36	18-75Vdc	±12Vdc	0.417A	89%
ERM00CC36	18-75Vdc	±15Vdc	0.335A	88%
ERM02A36B	18-75Vdc	5Vdc	2.0A	85%
ERM00B36B	18-75Vdc	12Vdc	0.83A	87%
ERM00C36B	18-75Vdc	15Vdc	0.67A	87%
ERM00H36B	18-75Vdc	24Vdc	0.417A	86%
ERM00BB36B	18-75Vdc	±12Vdc	0.417A	89%
ERM00CC36B	18-75Vdc	±15Vdc	0.335A	88%

MODEL NUMBERS

Model	Input Voltage	Output Voltage	Maximum Load	Efficiency
ERM02A110	40-160Vdc	5Vdc	2.0A	82%
ERM00B110	40-160Vdc	12Vdc	0.83A	85%
ERM00C110	40-160Vdc	15Vdc	0.67A	85%
ERM00H110	40-160Vdc	24Vdc	0.417A	85%
ERM00BB110	40-160Vdc	±12Vdc	0.417A	86%
ERM00CC110	40-160Vdc	±15Vdc	0.335A	86%
ERM02A110B	40-160Vdc	5Vdc	2.0A	82%
ERM00B110B	40-160Vdc	12Vdc	0.83A	85%
ERM00C110B	40-160Vdc	15Vdc	0.67A	85%
ERM00H110B	40-160Vdc	24Vdc	0.417A	85%
ERM00BB110B	40-160Vdc	±12Vdc	0.417A	86%
ERM00CC110B	40-160Vdc	±15Vdc	0.335A	86%

Note1 - Suffix "B" means baseplate, see mechanical drawing on page 45.

Options

None

ELECTRICAL SPECIFICATIONS

Absolute Maximum Ratings

Stress in excess of those listed in the “Absolute Maximum Ratings” may cause permanent damage to the power supply. These are stress ratings only and functional operation of the unit is not implied at these or any other conditions above those given in the operational sections of this TRN. Exposure to any absolute maximum rated condition for extended periods may adversely affect the power supply’s reliability.

Table 1. Absolute Maximum Ratings						
Parameter	Model	Symbol	Min	Typ	Max	Unit
Input Surge Voltage 100 mSec.max	24V Input Models 48V Input Models 110V Input Models	$V_{IN,DC}$	-0.7 -0.7 -0.7	- - -	50 100 170	Vdc Vdc Vdc
Maximum Output Power	All models	$P_{O,max}$	-	-	10	W
Isolation Voltage Input to output (60 seconds) Input / Output to Case (60 seconds)	All models All models		3000 1500	- -	- -	Vac Vac
Isolation Resistance (500Vdc)	All models		1000	-	-	Mohm
Isolation Capacitance (100KHz, 1V)	All models		-	1500	-	pF
Operating Case Temperature	All models	T_{CASE}	-	-	+105	°C
Storage Temperature	All models	T_{STG}	-50		+125	°C
Humidity (non-condensing) Operating Non-operating	All models All models		- -	- -	95 95	% %
MTBF	MIL-HDBK-217F@25°C, Ground Benign		2845385	-	-	Hours

ELECTRICAL SPECIFICATIONS

Input Specifications

Table 2. Input Specifications							
Parameter		Condition	Symbol	Min	Typ	Max	Unit
Operating Input Voltage, DC	24V Input Models	All	$V_{IN,DC}$	9	24	36	Vdc
	48V Input Models			18	48	75	Vdc
	110V Input Models			40	110	160	Vdc
Start-Up Threshold Voltage	24V Input Models	All	$V_{IN,ON}$	-	-	9	Vdc
	48V Input Models			-	-	18	Vdc
	110V Input Models			-	-	40	Vdc
Under Voltage Lockout	24V Input Models	All	$V_{IN,OFF}$	-	7.5	-	Vdc
	48V Input Models			-	16	-	Vdc
	110V Input Models			-	37	-	Vdc
Input Current	ERM02A18	$V_{IN,DC}=V_{IN,nom}$	$I_{IN,full\ load}$	-	496	-	mA
	ERM00B18			-	485	-	mA
	ERM00C18			-	481	-	mA
	ERM00H18			-	474	-	mA
	ERM00BB18			-	485	-	mA
	ERM00CC18			-	481	-	mA
	ERM02A36			-	245	-	mA
	ERM00B36			-	240	-	mA
	ERM00C36			-	241	-	mA
	ERM00H36			-	242	-	mA
	ERM00BB36			-	234	-	mA
	ERM00CC36			-	238	-	mA
	ERM02A110			-	111	-	mA
	ERM00B110			-	107	-	mA
	ERM00C110			-	107	-	mA
	ERM00H110			-	107	-	mA
ERM00BB110	-	106	-	mA			
ERM00CC110	-	106	-	mA			
Efficiency @Max. Load	ERM02A18	$V_{IN,DC}=V_{IN,nom}$ $I_O=I_{O,max}$ $T_A=25\text{ }^{\circ}\text{C}$	η	-	84	-	%
	ERM00B18			-	86	-	%
	ERM00C18			-	87	-	%
	ERM00H18			-	88	-	%
	ERM00BB18			-	86	-	%
	ERM00CC18			-	87	-	%
	ERM02A36			-	85	-	%
	ERM00B36			-	87	-	%
	ERM00C36			-	87	-	%
	ERM00H36			-	86	-	%
	ERM00BB36			-	89	-	%
	ERM00CC36			-	88	-	%
	ERM02A110			-	82	-	%
	ERM00B110			-	85	-	%
	ERM00C110			-	85	-	%
	ERM00H110			-	85	-	%
ERM00BB110	-	86	-	%			
ERM00CC110	-	86	-	%			

ELECTRICAL SPECIFICATIONS

Input Specifications

Table 2. Input Specifications con't							
Parameter		Condition	Symbol	Min	Typ	Max	Unit
No Load Input Current (V _O On, I _O = 0A)	24V Input Models	$V_{IN,DC}=V_{IN,nom}$	I_{IN,no_load}	-	25	-	mA
	48V Input Models			-	15	-	mA
	110V Input Models			-	10	-	mA
Start Up Time (Power On)	All Models	$V_{IN,DC}=V_{IN,nom}$		-	50	-	mSec
Input Filter		All	Internal Pi Type				

ELECTRICAL SPECIFICATIONS

Output Specifications

Table 3. Output Specifications							
Parameter	Condition	Symbol	Min	Typ	Max	Unit	
Output Voltage Set Point	$V_{IN,DC}=V_{IN,nom}$ $I_O=I_{O,max}, T_A=25\text{ }^{\circ}\text{C}$	$\pm V_O$	-	-	1.0	%	
Line Regulation	$V_{IN,DC}=V_{IN,min}$ to $V_{IN,max}$	$\pm\%V_O$	-	-	0.2	%	
Load Regulation	$I_O=I_{O,min}$ to $I_{O,max}$	$\pm\%V_O$	-	-	0.5	%	
			-	-	0.1	%	
Output Current	ERM02A18	All ¹	I_O	-	-	2000	mA
	ERM00B18			-	-	835	mA
	ERM00C18			-	-	670	mA
	ERM00H18			-	-	417	mA
	ERM00BB18			-	-	± 417	mA
	ERM00CC18			-	-	± 335	mA
	ERM02A36			-	-	2000	mA
	ERM00B36			-	-	835	mA
	ERM00C36			-	-	670	mA
	ERM00H36			-	-	417	mA
	ERM00BB36			-	-	± 417	mA
	ERM00CC36			-	-	± 335	mA
	ERM02A110			-	-	2000	mA
	ERM00B110			-	-	835	mA
	ERM00C110			-	-	670	mA
	ERM00H110			-	-	417	mA
ERM00BB110	-	-	± 417	mA			
ERM00CC110	-	-	± 335	mA			
Load Capacitance	ERM02A18	All	C_O	-	-	2200	μF
	ERM00B18			-	-	330	μF
	ERM00C18			-	-	220	μF
	ERM00H18			-	-	100	μF
	ERM00BB18			-	-	150^2	μF
	ERM00CC18			-	-	100^2	μF
	ERM02A36			-	-	2200	μF
	ERM00B36			-	-	330	μF
	ERM00C36			-	-	220	μF
	ERM00H36			-	-	100	μF
	ERM00BB36			-	-	150^2	μF
	ERM00CC36			-	-	100^2	μF
	ERM02A110			-	-	2200	μF
	ERM00B110			-	-	330	μF
	ERM00C110			-	-	220	μF
	ERM00H110			-	-	100	μF
ERM00BB110	-	-	150^2	μF			
ERM00CC110	-	-	100^2	μF			

Note 1 - No minimum Load Requirement

Note 2 - For each output

ELECTRICAL SPECIFICATIONS

Output Specifications

Table 3. Output Specifications Con't							
Parameter		Condition	Symbol	Min	Nom	Max	Unit
Ripple & Noise, pk-pk	5V Output Models 12V Output Models 15V Output Models ±12V Output Models ±15V Output Models	0 to 20MHz bandwidth Measure with a 10uF/25V MLCC	V_o	- - - - -	50 100 100 100 100	- - - - -	mV
	24V Output Models	0 to 20MHz bandwidth Measure with a 4.7uF/50V MLCC	V_o	-	150	-	mV
V_o Dynamic Response		25% load change	Peak Deviation Recovery Time ³	$\pm\%V_o$	-	3	% uSec
				$\pm\%V_{SB}$	-	-	
Switching Frequency		All	f_{sw}	-	280	-	KHz
Trim Up / Down Range ⁴		% of Nominal Output Voltage		-	-	±10	%
Output Over Current Protection		All	$\%I_{O,max}$	-	150	-	%
Output Short Circuit Protection		All		Hiccup Mode 0.3Hz type, Automatic Recovery			
Over Voltage Protection	ERM02A18	All	V_o	-	6.2	-	Vdc
	ERM00B18			-	15	-	Vdc
	ERM00C18			-	18	-	Vdc
	ERM00H18			-	30	-	Vdc
	ERM00BB18			-	±15	-	Vdc
	ERM00CC18			-	±18	-	Vdc
	ERM02A36			-	6.2	-	Vdc
	ERM00B36			-	15	-	Vdc
	ERM00C36			-	18	-	Vdc
	ERM00H36			-	30	-	Vdc
	ERM00BB36			-	±15	-	Vdc
	ERM00CC36			-	±18	-	Vdc
	ERM02A110			-	6.2	-	Vdc
	ERM00B110			-	15	-	Vdc
	ERM00C110			-	18	-	Vdc
	ERM00H110			-	30	-	Vdc
ERM00BB110	-	±15	-	Vdc			
ERM00CC110	-	±18	-	Vdc			

Note 3 - Transient recovery time is measured to within 1% error band for a step change in output load of 75% to 100%.

Note 4 - See details on page 55.

ELECTRICAL SPECIFICATIONS

ERM02A18 Performance Curves

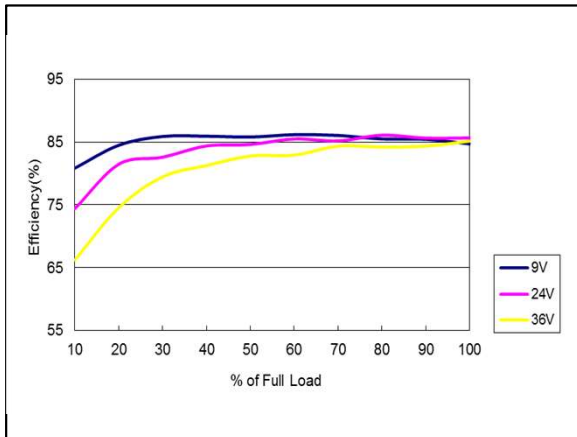

Figure 1: ERM02A18 Efficiency Versus Output Current Curve
 Vin = 9 to 36Vdc Load: Io = 0 to 2.0A

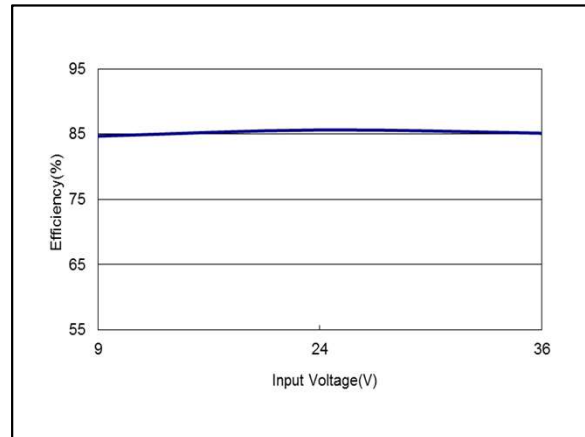

Figure 2: ERM02A18 Efficiency Versus Input Voltage Curve
 Vin = 9 to 36Vdc Load: Io = 2.0A

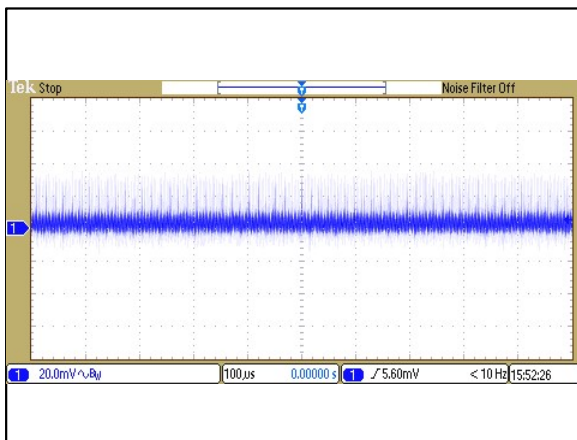

Figure 3: ERM02A18 Ripple and Noise Measurement
 Vin = 24Vdc Load: Io = 2.0A
 Ch 1: Vo

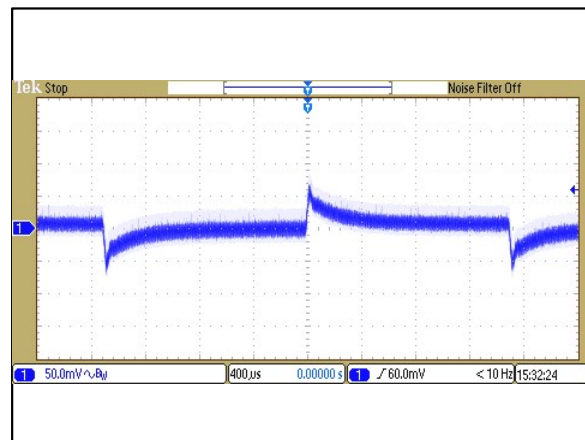

Figure 4: ERM02A18 Transient Response
 Vin = 24Vdc Load: Io = 100% to 75% load change
 Ch 1: Vo

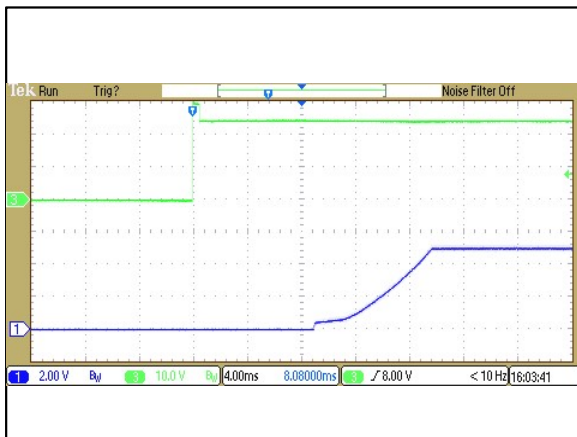

Figure 5: ERM02A18 Output Voltage Startup Characteristic by Vin
 Vin = 24Vdc Load: Io = 2.0A
 Ch 1: Vo Ch 3: Vin

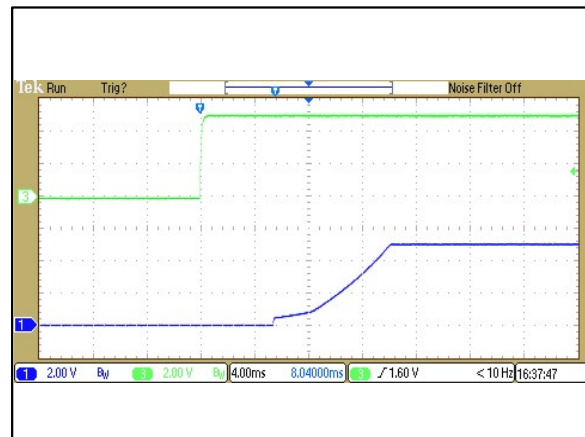

Figure 6: ERM02A18 Output Voltage Startup Characteristic by VON/OFF
 Vin = 24Vdc Load: Io = 2.0A
 Ch 1: Vo Ch 3: VON/OFF

ELECTRICAL SPECIFICATIONS

ERM02A18 Performance Curves

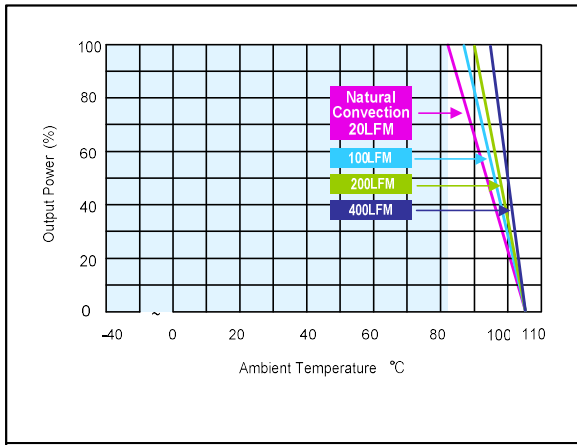

Figure 7: ERM02A18 Derating Output Current vs Ambient Temperature and Airflow (without heatsink)
 Vin = 24Vdc Load: Io = 0 to 2.0A

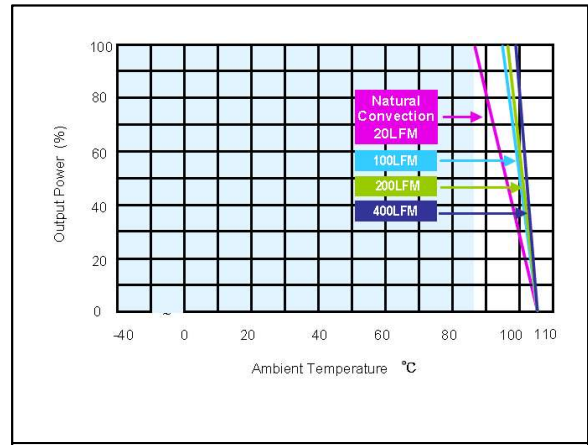

Figure 8: ERM02A18 Derating Output Current vs Ambient Temperature and Airflow (with heatsink)
 Vin = 24Vdc Load: Io = 0 to 2.0A

ELECTRICAL SPECIFICATIONS

ERM00B18 Performance Curves

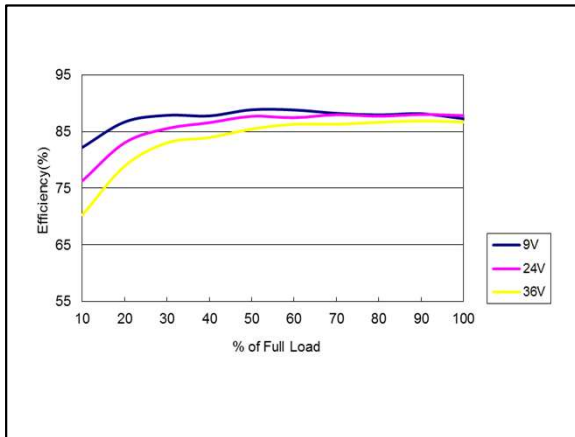

Figure 9: ERM00B18 Efficiency Versus Output Current Curve
 Vin = 9 to 36Vdc Load: $I_o = 0$ to 0.835A

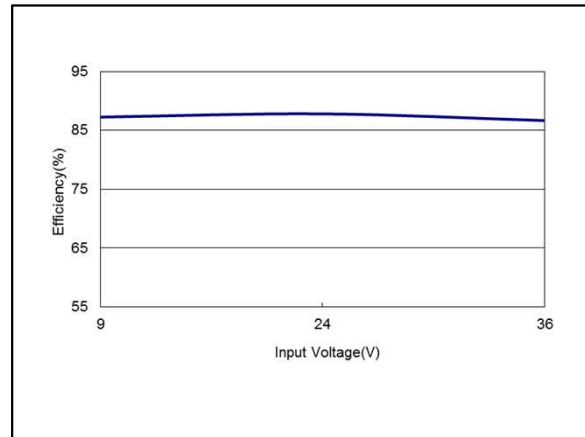

Figure 10: ERM00B18 Efficiency Versus Input Voltage Curve
 Vin = 9 to 36Vdc Load: $I_o = 0.835A$

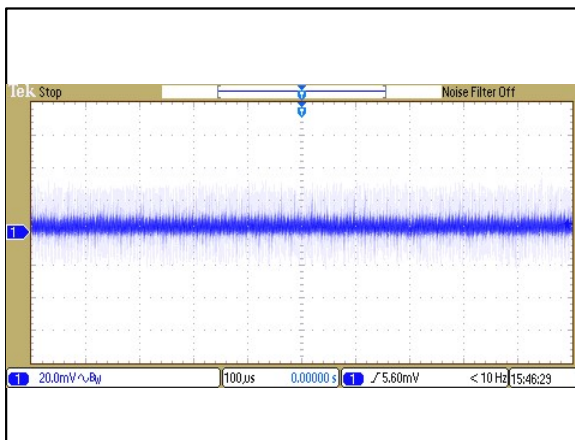

Figure 11: ERM00B18 Ripple and Noise Measurement
 Vin = 24Vdc Load: $I_o = 0.835A$
 Ch 1: Vo

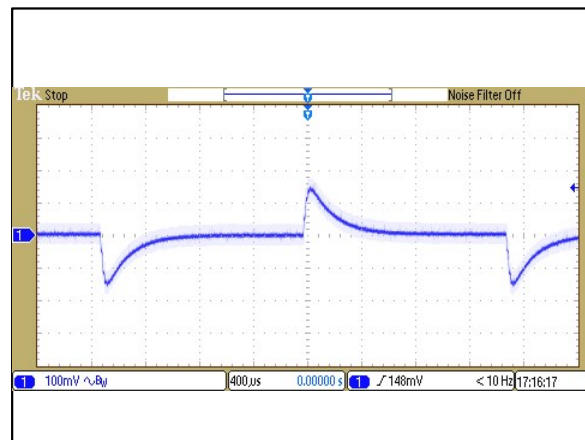

Figure 12: ERM00B18 Transient Response
 Vin = 24Vdc Load: $I_o = 100\%$ to 75% load change
 Ch 1: Vo

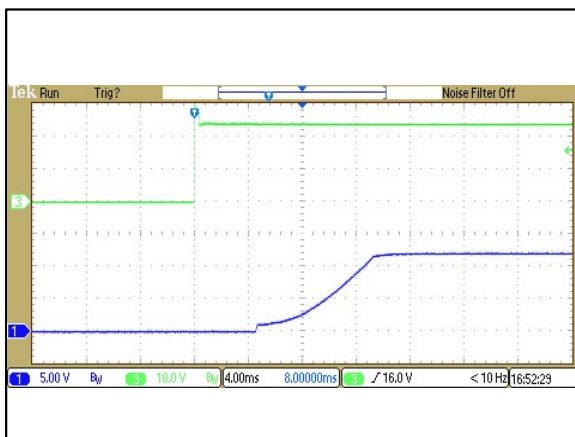

Figure 13: ERM00B18 Output Voltage Startup Characteristic by Vin
 Vin = 24Vdc Load: $I_o = 0.835A$
 Ch 1: Vo Ch 3: Vin

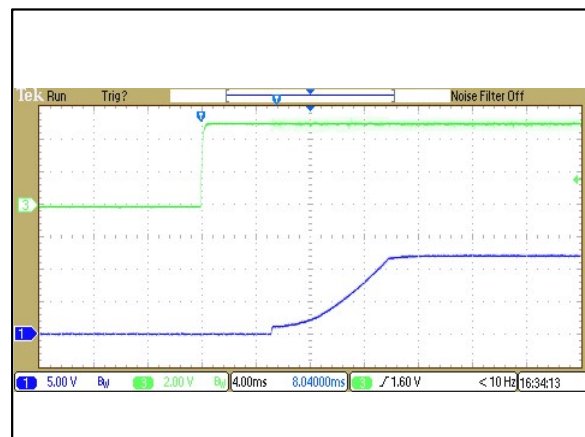

Figure 14: ERM00B18 Output Voltage Startup Characteristic by $V_{ON/OFF}$
 Vin = 24Vdc Load: $I_o = 0.835A$
 Ch 1: Vo Ch 3: $V_{ON/OFF}$

ELECTRICAL SPECIFICATIONS

ERM00B18 Performance Curves

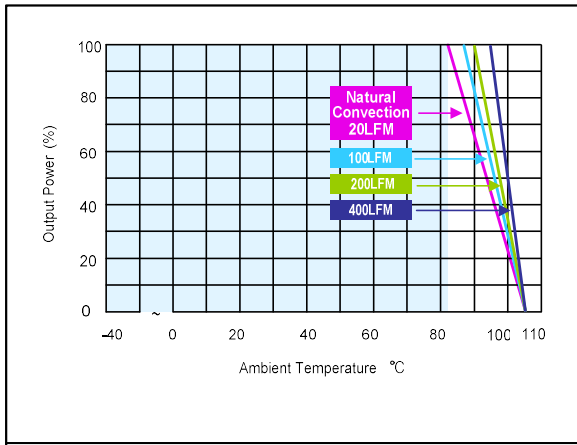

Figure 15: ERM00B18 Derating Output Current vs Ambient Temperature and Airflow (without heatsink)
 Vin = 24Vdc Load: Io = 0 to 0.835A

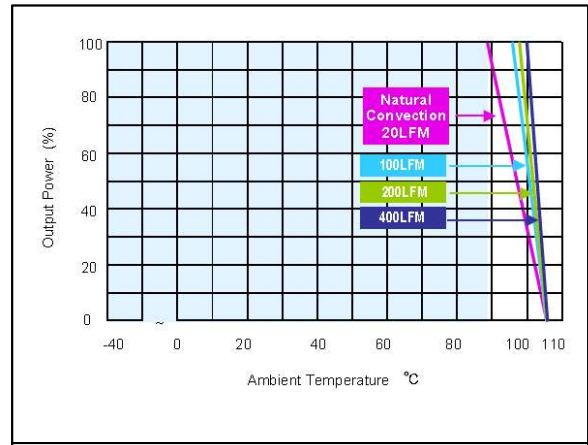

Figure 16: ERM00B18 Derating Output Current vs Ambient Temperature and Airflow (with heatsink)
 Vin = 24Vdc Load: Io = 0 to 0.835A

ELECTRICAL SPECIFICATIONS

ERM00C18 Performance Curves

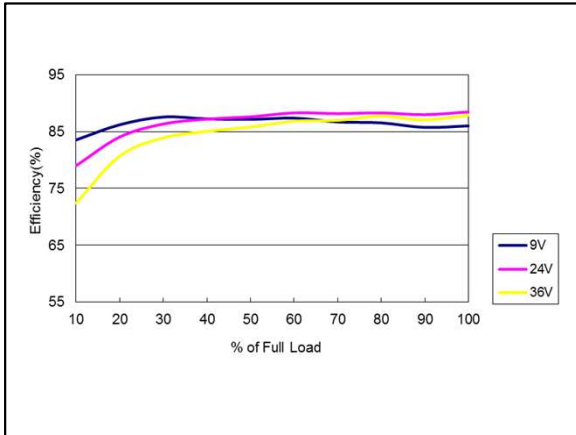

Figure 17: ERM00C18 Efficiency Versus Output Current Curve
 Vin = 9 to 36Vdc Load: Io = 0 to 0.67A

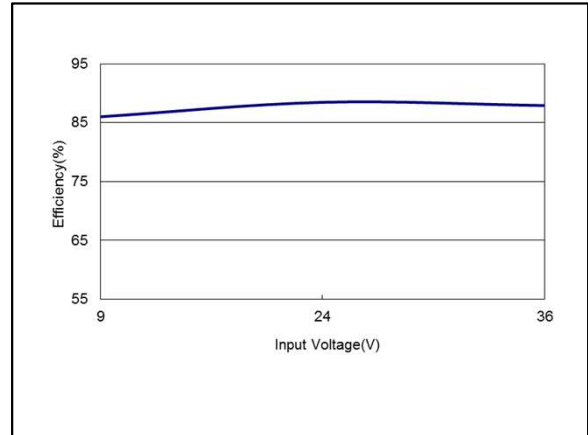

Figure 18: ERM00C18 Efficiency Versus Input Voltage Curve
 Vin = 9 to 36Vdc Load: Io = 0.67A

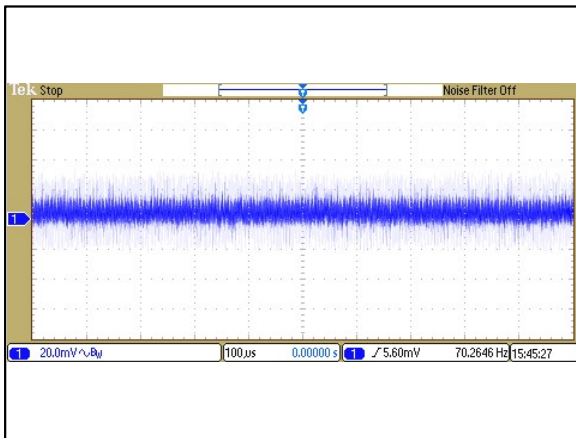

Figure 19: ERM00C18 Ripple and Noise Measurement
 Vin = 24Vdc Load: Io = 0.67A
 Ch 1: Vo

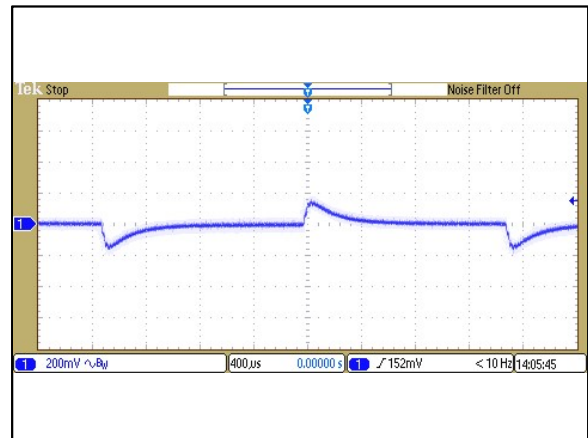

Figure 20: ERM00C18 Transient Response
 Vin = 24Vdc Load: Io = 100% to 75% load change
 Ch 1: Vo

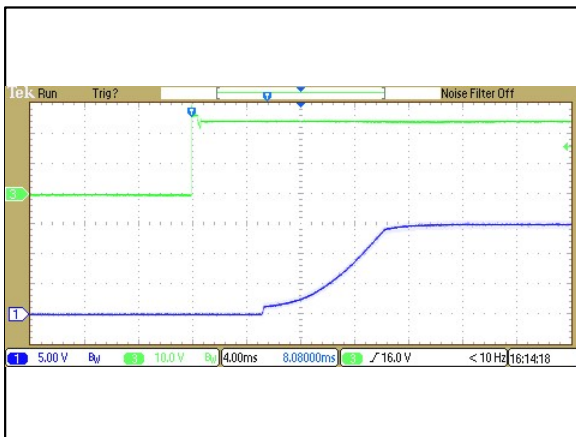

Figure 21: ERM00C18 Output Voltage Startup Characteristic by Vin
 Vin = 24Vdc Load: Io = 0.67A
 Ch 1: Vo Ch 3: Vin

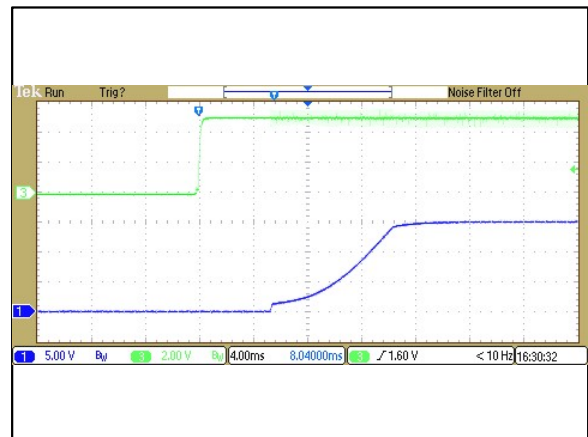

Figure 22: ERM00C18 Output Voltage Startup Characteristic by V_{ON/OFF}
 Vin = 24Vdc Load: Io = 0.67A
 Ch 1: Vo Ch 3: V_{ON/OFF}

ELECTRICAL SPECIFICATIONS

ERM00C18 Performance Curves

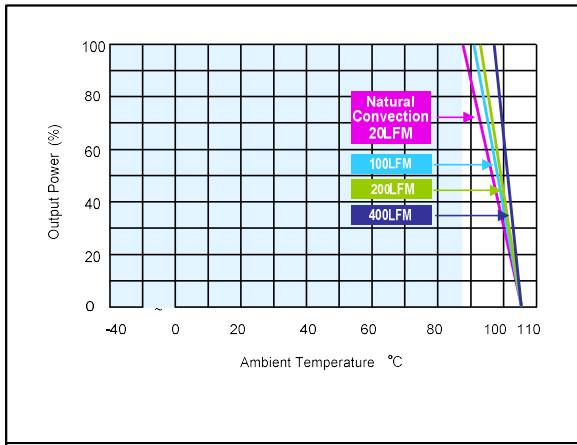

Figure 23: ERM00C18 Derating Output Current vs Ambient Temperature and Airflow (without heatsink)
 Vin = 24Vdc Load: Io = 0 to 0.67A

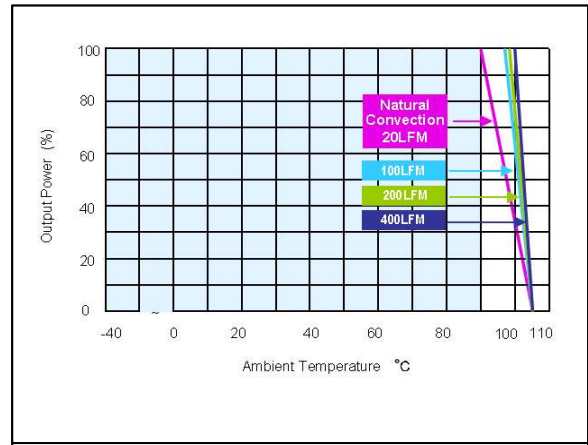

Figure 24: ERM00C18 Derating Output Current vs Ambient Temperature and Airflow (with heatsink)
 Vin = 24Vdc Load: Io = 0 to 0.67A

ELECTRICAL SPECIFICATIONS

ERM00H18 Performance Curves

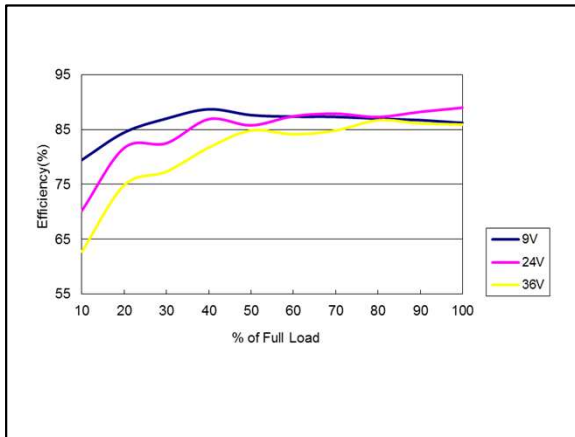

Figure 25: ERM00H18 Efficiency Versus Output Current Curve
 Vin = 9 to 36Vdc Load: Io = 0 to 0.417A

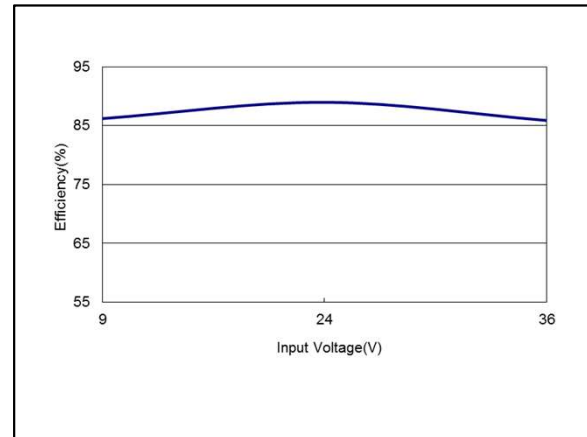

Figure 26: ERM00H18 Efficiency Versus Input Voltage Curve
 Vin = 9 to 36Vdc Load: Io = 0.417A

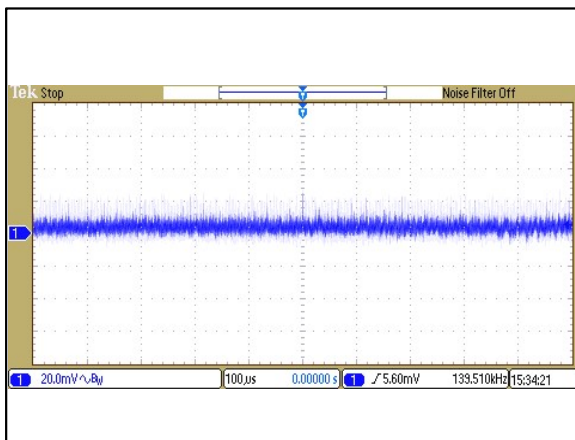

Figure 27: ERM00H18 Ripple and Noise Measurement
 Vin = 24Vdc Load: Io = 0.417A
 Ch 1: Vo

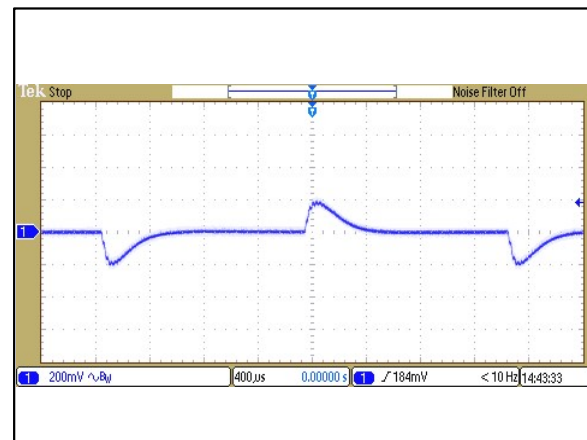

Figure 28: ERM00H18 Transient Response
 Vin = 24Vdc Load: Io = 100% to 75% load change
 Ch 1: Vo

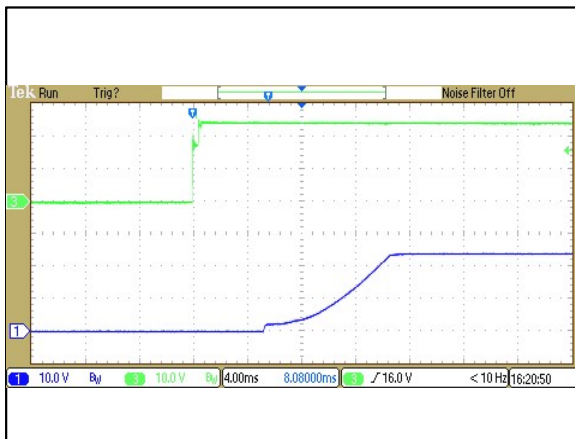

Figure 29: ERM00H18 Output Voltage Startup Characteristic by Vin
 Vin = 24Vdc Load: Io = 0.417A
 Ch 1: Vo Ch 3: Vin

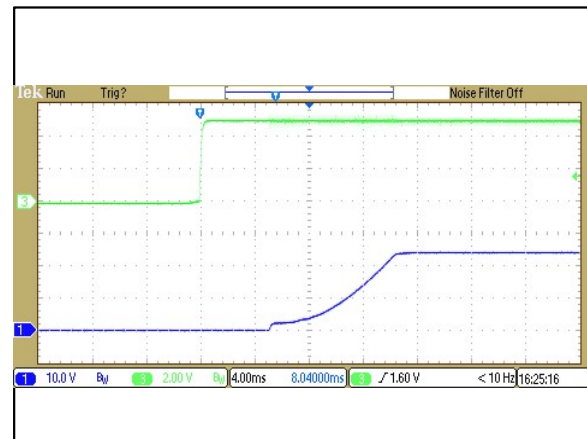

Figure 30: ERM00H18 Output Voltage Startup Characteristic by V_{ON/OFF}
 Vin = 24Vdc Load: Io = 0.417A
 Ch 1: Vo Ch 3: V_{ON/OFF}

ELECTRICAL SPECIFICATIONS

ERM00H18 Performance Curves

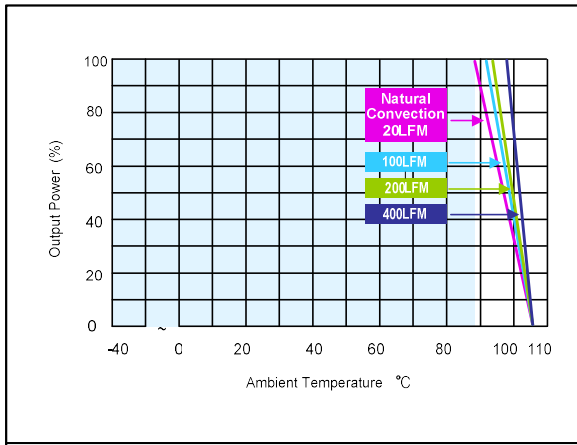

Figure 31: ERM00H18 Derating Output Current vs Ambient Temperature and Airflow (without heatsink)
 Vin = 24Vdc Load: Io = 0 to 0.417A

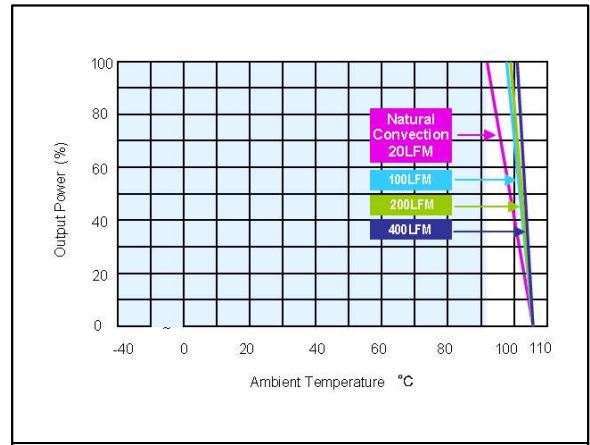

Figure 32: ERM00H18 Derating Output Current vs Ambient Temperature and Airflow (with heatsink)
 Vin = 24Vdc Load: Io = 0 to 0.417A

ELECTRICAL SPECIFICATIONS

ERM00BB18 Performance Curves

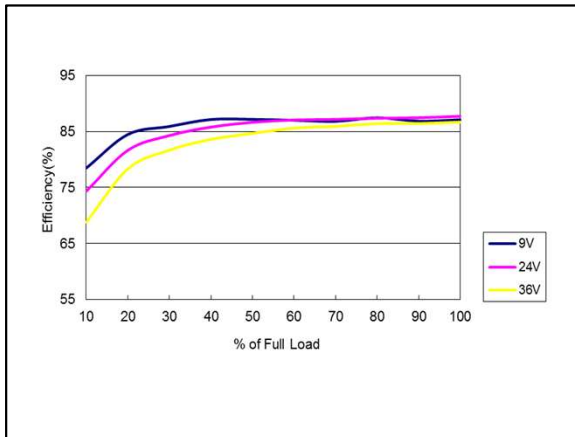

Figure 33: ERM00BB18 Efficiency Versus Output Current Curve
 Vin = 9 to 36Vdc Load: Io = 0 to ±0.417A

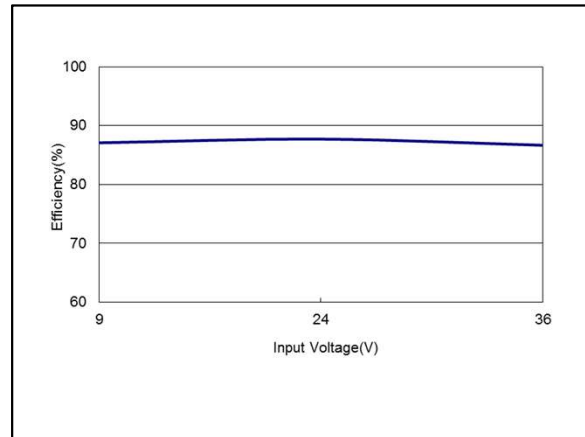

Figure 34: ERM00BB18 Efficiency Versus Input Voltage Curve
 Vin = 9 to 36Vdc Load: Io = ±0.417A

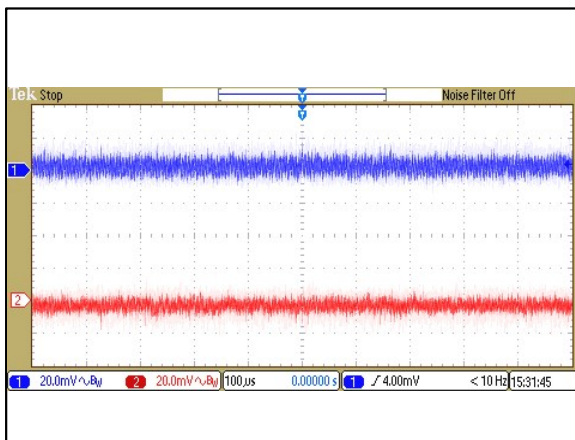

Figure 35: ERM00BB18 Ripple and Noise Measurement
 Vin = 24Vdc Load: Io = ±0.417A
 Ch 1: Vo1 Ch 2: Vo2

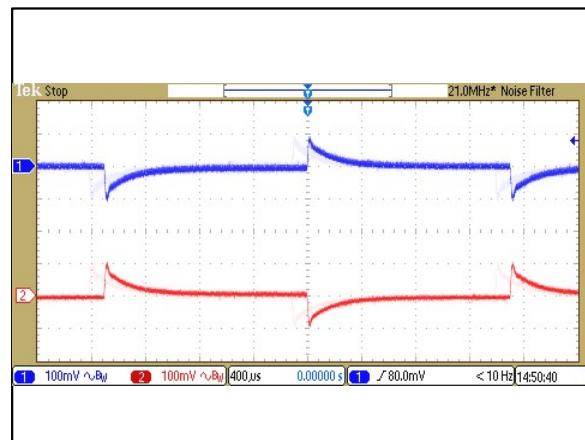

Figure 36: ERM00BB18 Transient Response
 Vin = 24Vdc Load: Io = 100% to 75% load change
 Ch 1: Vo1 Ch 2: Vo2

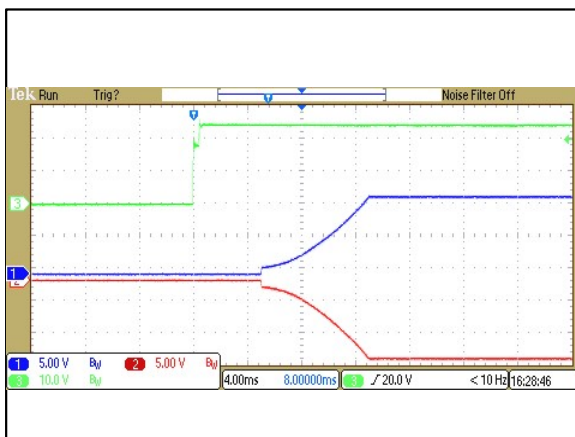

Figure 37: ERM00BB18 Output Voltage Startup Characteristic by Vin
 Vin = 24Vdc Load: Io = ±0.417A
 Ch 1: Vo1 Ch 2: Vo2 Ch 3: Vin

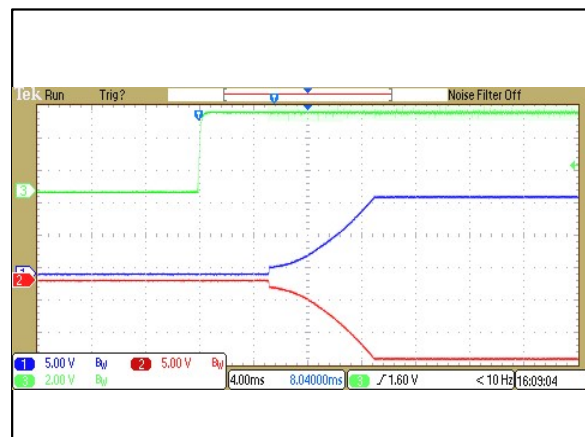

Figure 38: ERM00BB18 Output Voltage Startup Characteristic by VON/OFF
 Vin = 24Vdc Load: Io = ±0.417A
 Ch 1: Vo1 Ch 2: Vo2 Ch 3: VON/OFF

ELECTRICAL SPECIFICATIONS

ERM00BB18 Performance Curves

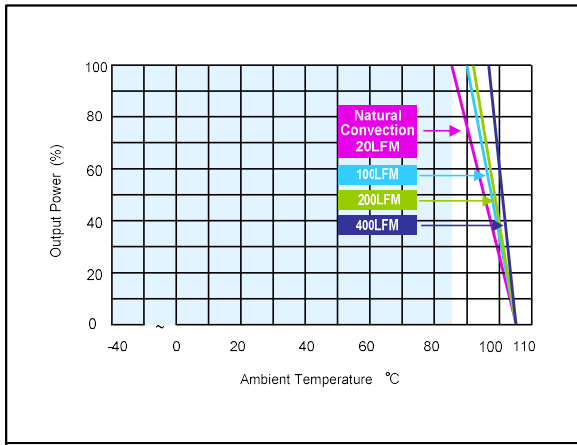

Figure 39: ERM00BB18 Derating Output Current vs Ambient Temperature and Airflow (without heatsink)
 Vin = 24Vdc Load: Io = 0 to ±0.417A

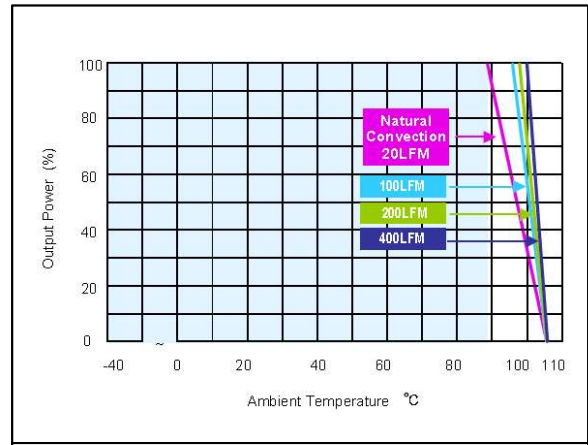

Figure 40: ERM00BB18 Derating Output Current vs Ambient Temperature and Airflow (with heatsink)
 Vin = 24Vdc Load: Io = 0 to ±0.417A

ELECTRICAL SPECIFICATIONS

ERM00CC18 Performance Curves

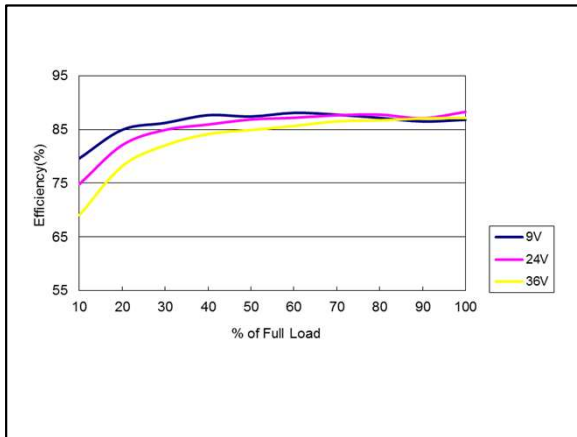

Figure 41: ERM00CC18 Efficiency Versus Output Current Curve
 Vin = 9 to 36Vdc Load: Io = 0 to ±0.335A

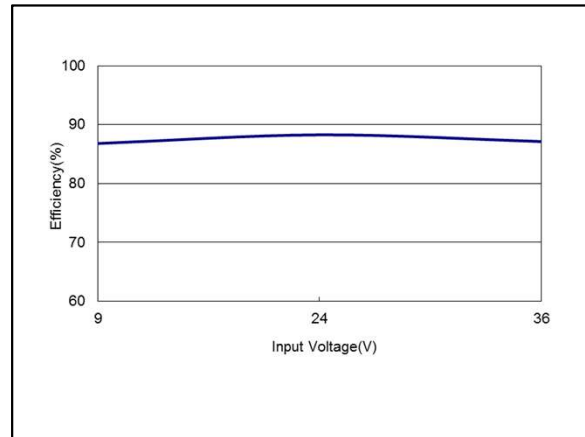

Figure 42: ERM00CC18 Efficiency Versus Input Voltage Curve
 Vin = 9 to 36Vdc Load: Io = ±0.335A

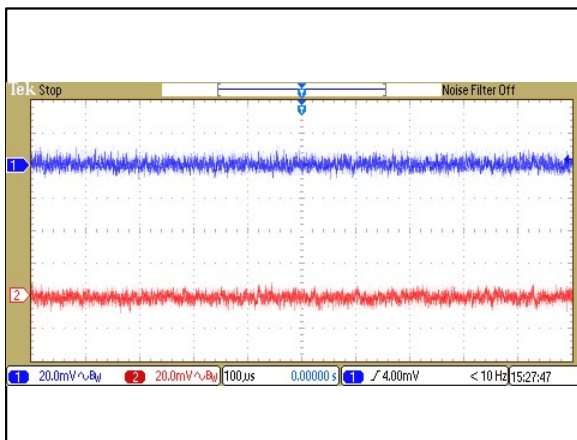

Figure 43: ERM00CC18 Ripple and Noise Measurement
 Vin = 24Vdc Load: Io = ±0.335A
 Ch 1: Vo1 Ch 2: Vo2

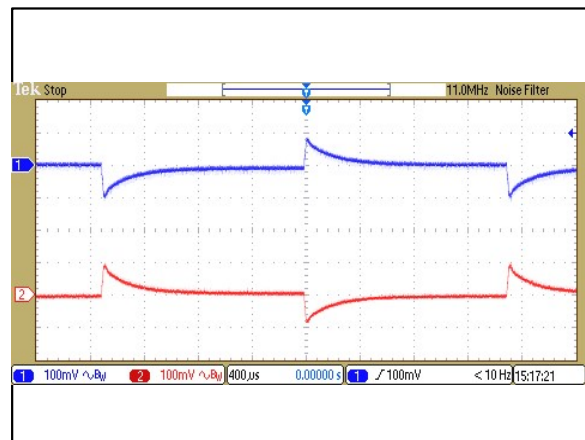

Figure 44: ERM00CC18 Transient Response
 Vin = 24Vdc Load: Io = 100% to 75% load change
 Ch 1: Vo1 Ch 2: Vo2

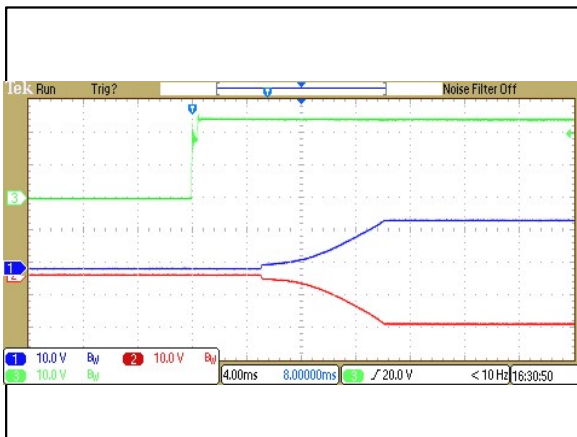

Figure 45: ERM00CC18 Output Voltage Startup Characteristic by Vin
 Vin = 24Vdc Load: Io = ±0.335A
 Ch 1: Vo1 Ch 2: Vo2 Ch 3: Vin

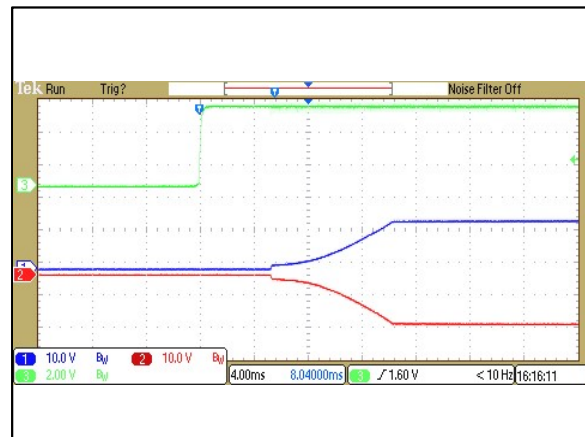

Figure 46: ERM00CC18 Output Voltage Startup Characteristic by VON/OFF
 Vin = 24Vdc Load: Io = ±0.335A
 Ch 1: Vo1 Ch 2: Vo2 Ch 3: VON/OFF

ELECTRICAL SPECIFICATIONS

ERM00CC18 Performance Curves

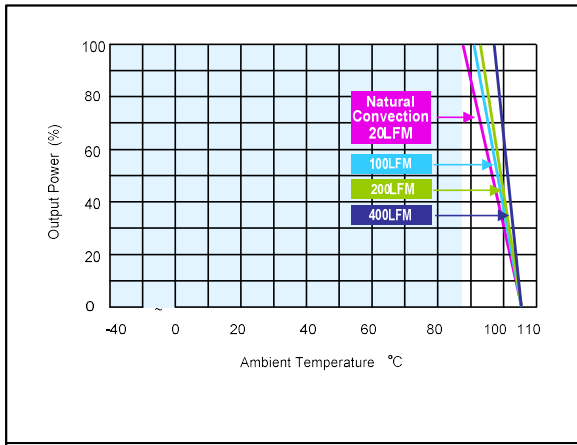

Figure 47: ERM00CC18 Derating Output Current vs Ambient Temperature and Airflow (without heatsink)
 Vin = 24Vdc Load: Io = 0 to ±0.335A

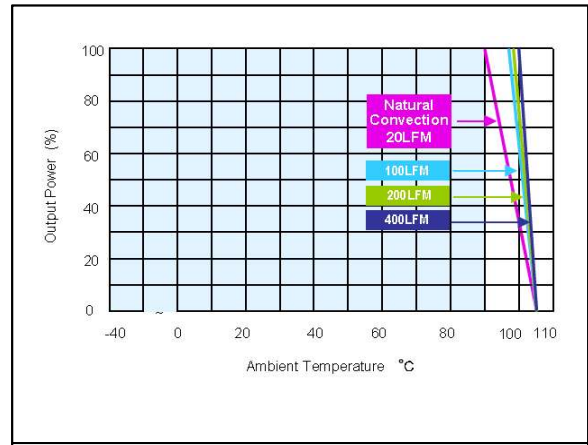

Figure 48: ERM00CC18 Derating Output Current vs Ambient Temperature and Airflow (with heatsink)
 Vin = 24Vdc Load: Io = 0 to ±0.335A

ELECTRICAL SPECIFICATIONS

ERM02A36 Performance Curves

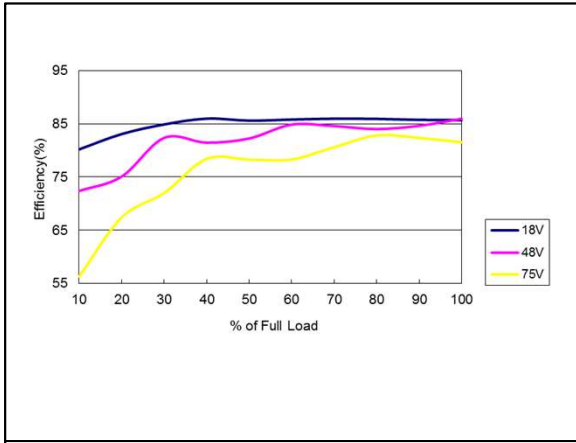

Figure 49: ERM02A36 Efficiency Versus Output Current Curve
 Vin = 9 to 36Vdc Load: Io = 0 to 0.835A

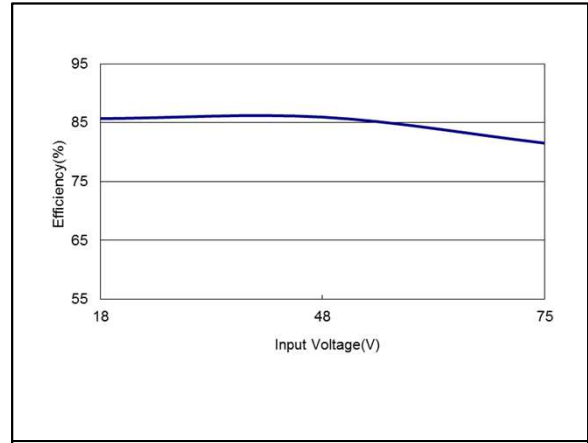

Figure 50: ERM02A36 Efficiency Versus Input Voltage Curve
 Vin = 9 to 36Vdc Load: Io = 0.835A

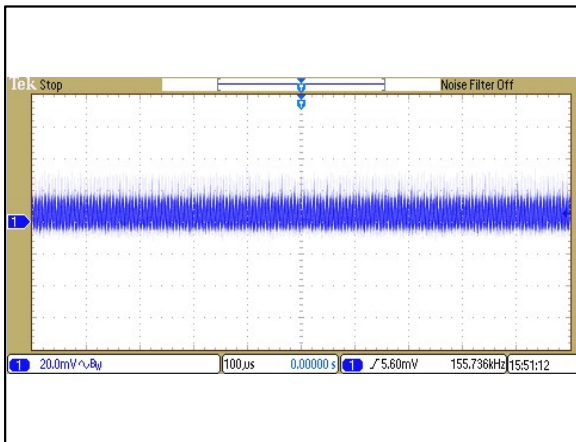

Figure 51: ERM02A36 Ripple and Noise Measurement
 Vin = 24Vdc Load: Io = 0.835A
 Ch 1: Vo

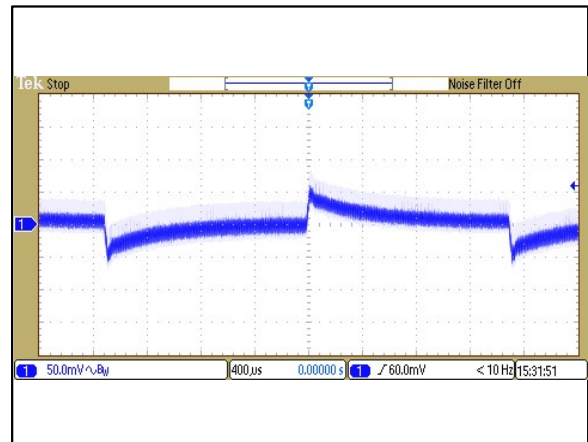

Figure 52: ERM02A36 Transient Response
 Vin = 24Vdc Load: Io = 100% to 75% load change
 Ch 1: Vo

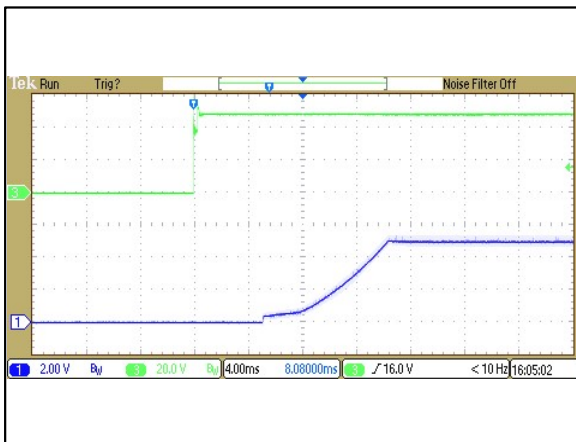

Figure 53: ERM02A36 Output Voltage Startup Characteristic by Vin
 Vin = 24Vdc Load: Io = 0.835A
 Ch 1: Vo Ch 3: Vin

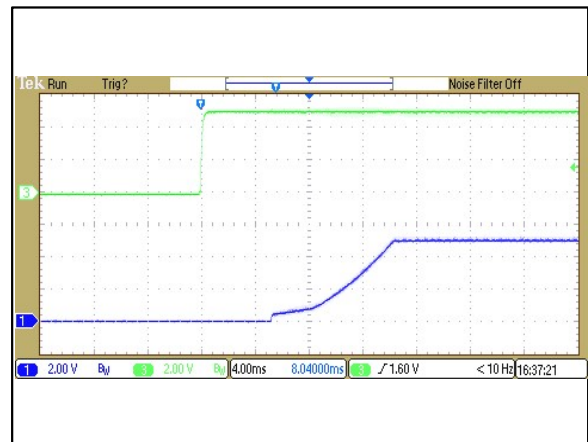

Figure 54: ERM02A36 Output Voltage Startup Characteristic by VON/OFF
 Vin = 24Vdc Load: Io = 0.835A
 Ch 1: Vo Ch 3: VON/OFF

ELECTRICAL SPECIFICATIONS

ERM02A36 Performance Curves

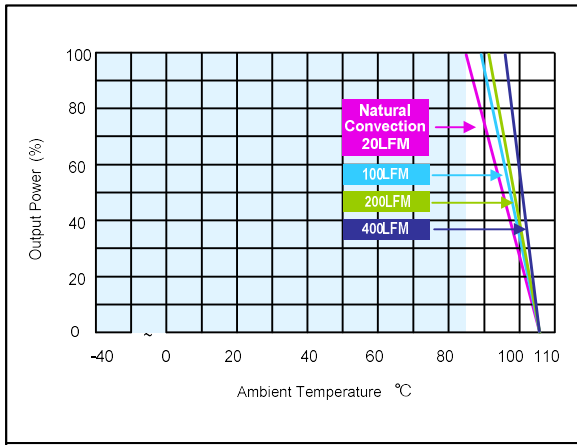

Figure 55: ERM02A36 Derating Output Current vs Ambient Temperature and Airflow (without heatsink)
 Vin = 24Vdc Load: Io = 0 to 0.835A

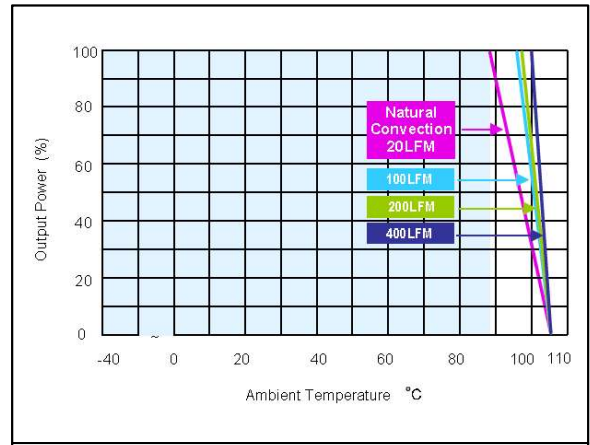

Figure 56: ERM02A36 Derating Output Current vs Ambient Temperature and Airflow (with heatsink)
 Vin = 24Vdc Load: Io = 0 to 0.835A

ELECTRICAL SPECIFICATIONS

ERM00B36 Performance Curves

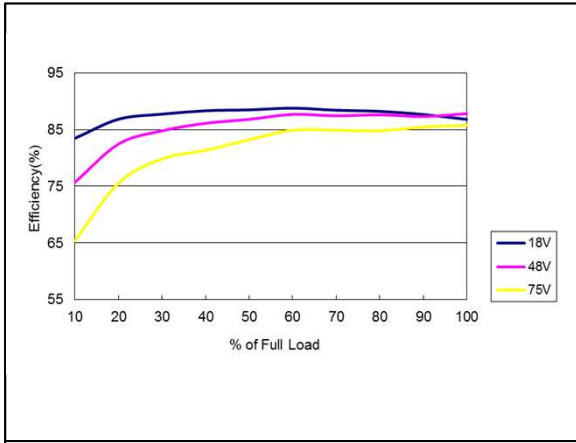

Figure 57: ERM00B36 Efficiency Versus Output Current Curve
 Vin = 18 to 75Vdc Load: Io = 0 to 0.83A

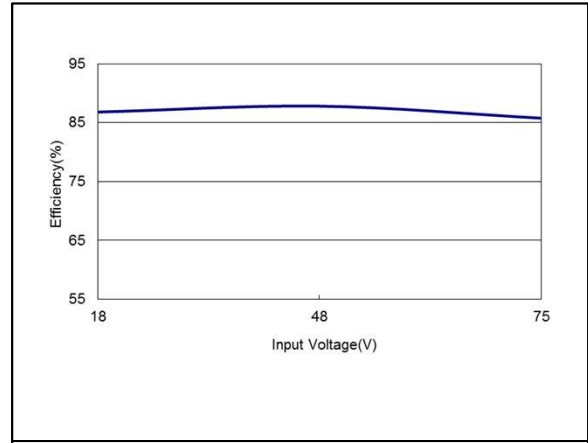

Figure 58: ERM00B36 Efficiency Versus Input Voltage Curve
 Vin = 18 to 75Vdc Load: Io = 0.83A

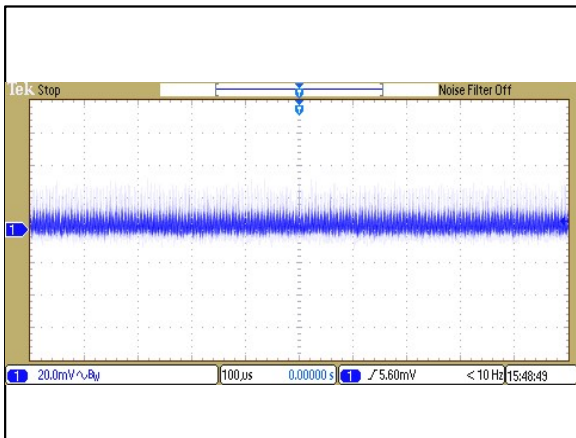

Figure 59: ERM00B36 Ripple and Noise Measurement
 Vin = 48Vdc Load: Io = 0.83A
 Ch 1: Vo

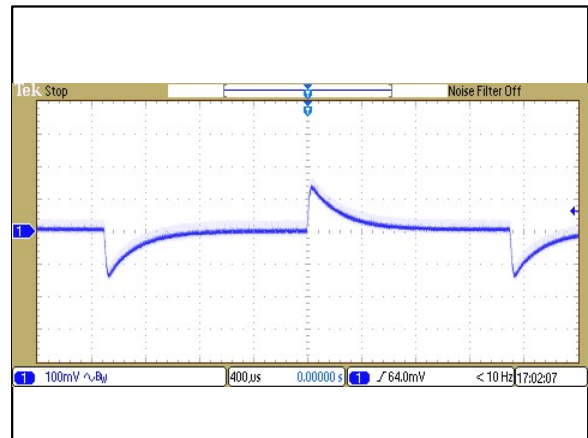

Figure 60: ERM00B36 Transient Response
 Vin = 48Vdc Load: Io = 100% to 75% load change
 Ch 1: Vo

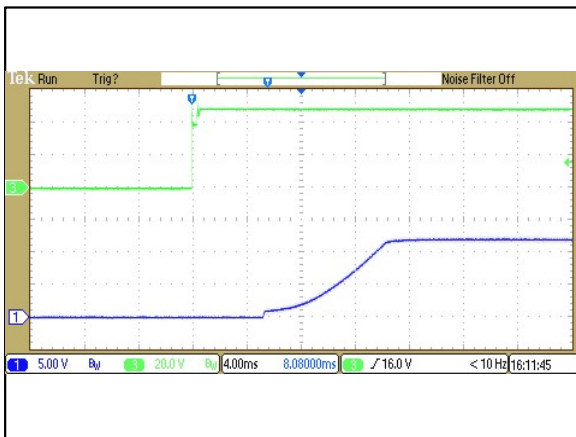

Figure 61: ERM00B36 Output Voltage Startup Characteristic by Vin
 Vin = 48Vdc Load: Io = 0.83A
 Ch 1: Vo Ch 3: Vin

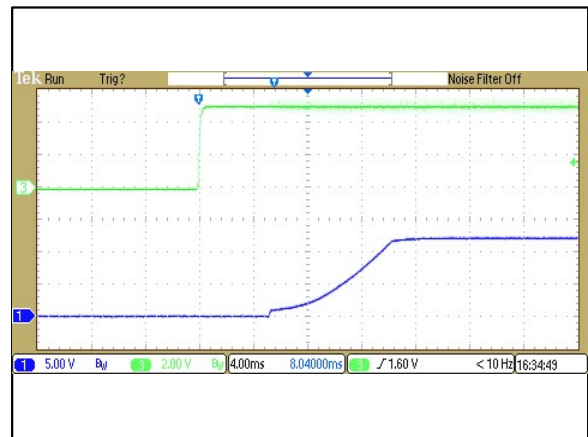

Figure 62: ERM00B36 Output Voltage Startup Characteristic by VON/OFF
 Vin = 48Vdc Load: Io = 0.83A
 Ch 1: Vo Ch 3: VON/OFF

ELECTRICAL SPECIFICATIONS

ERM00B36 Performance Curves

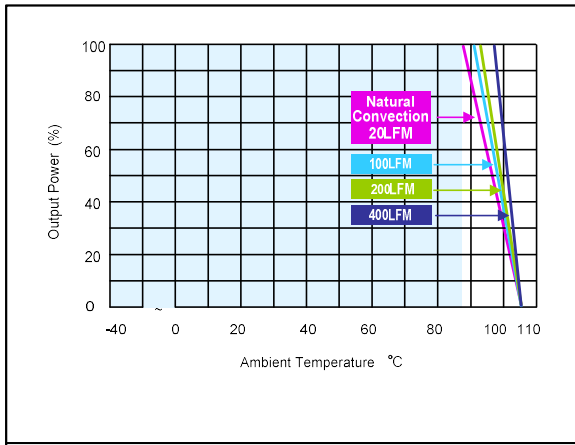

Figure 63: ERM00B36 Derating Output Current vs Ambient Temperature and Airflow (without heatsink)
 Vin = 48Vdc Load: Io = 0 to 0.83A

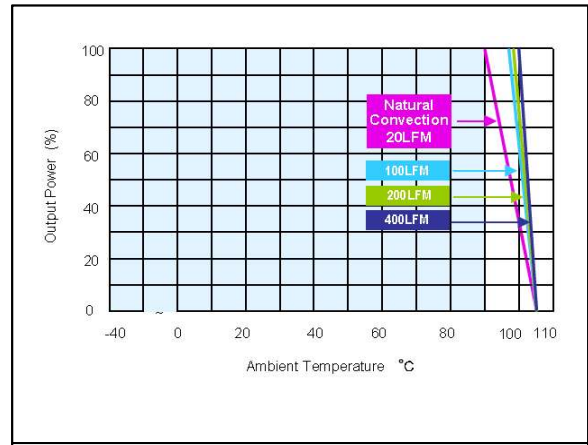

Figure 64: ERM00B36 Derating Output Current vs Ambient Temperature and Airflow (with heatsink)
 Vin = 48Vdc Load: Io = 0 to 0.83A

ELECTRICAL SPECIFICATIONS

ERM00C36 Performance Curves

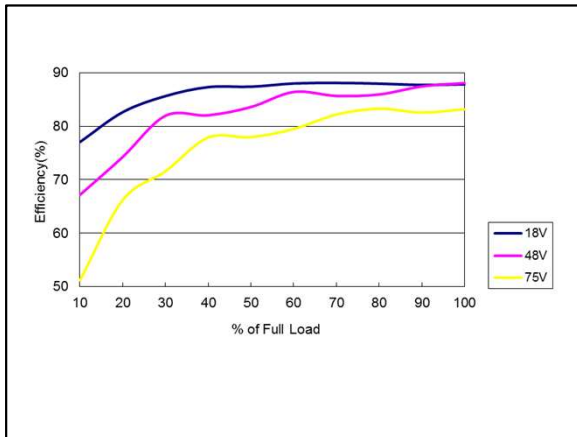

Figure 65: ERM00C36 Efficiency Versus Output Current Curve
 Vin = 18 to 75Vdc Load: $I_o = 0$ to 0.67A

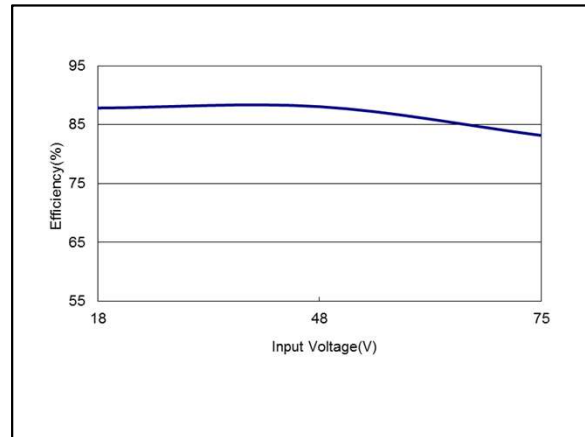

Figure 66: ERM00C36 Efficiency Versus Input Voltage Curve
 Vin = 18 to 75Vdc Load: $I_o = 0.67A$

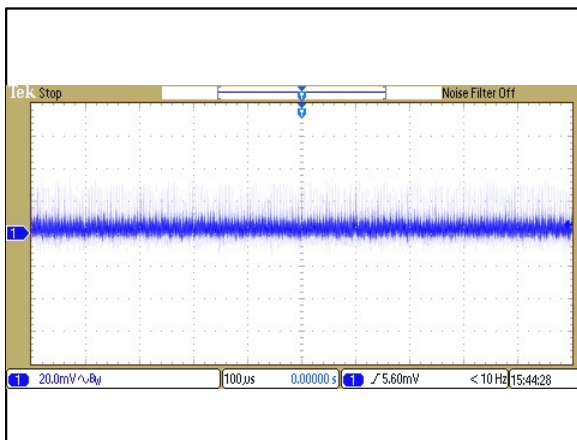

Figure 67: ERM00C36 Ripple and Noise Measurement
 Vin = 48Vdc Load: $I_o = 0.67A$
 Ch 1: Vo

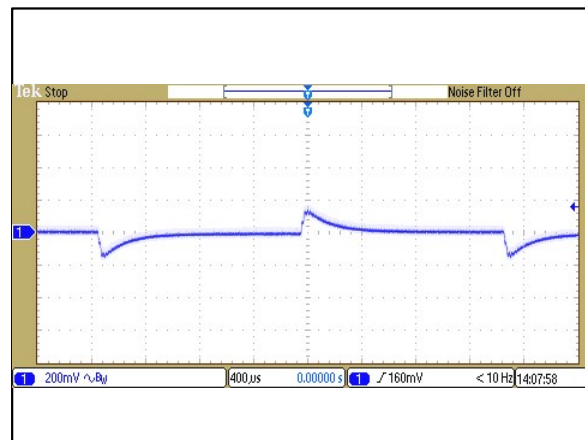

Figure 68: ERM00C36 Transient Response
 Vin = 48Vdc Load: $I_o = 100\%$ to 75% load change
 Ch 1: Vo

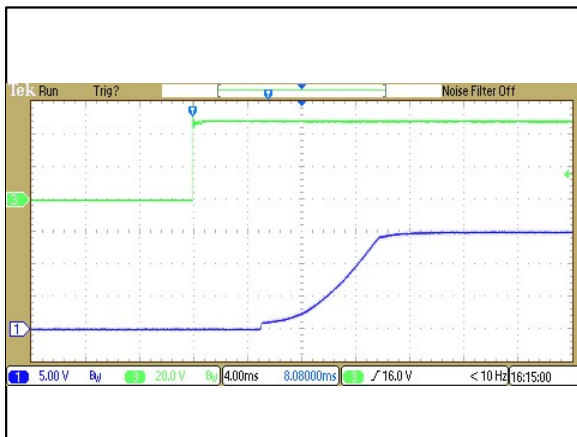

Figure 69: ERM00C36 Output Voltage Startup Characteristic by Vin
 Vin = 48Vdc Load: $I_o = 0.67A$
 Ch 1: Vo Ch 3: Vin

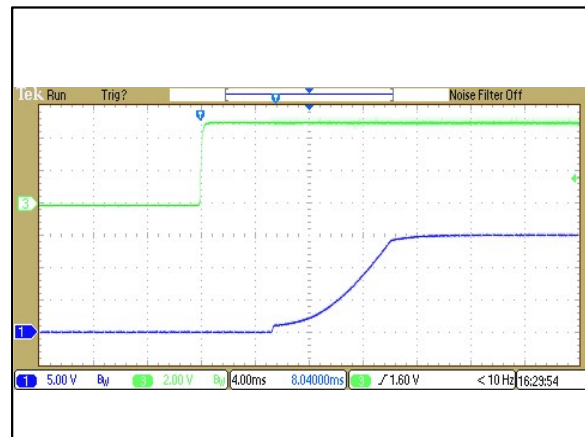

Figure 70: ERM00C36 Output Voltage Startup Characteristic by $V_{ON/OFF}$
 Vin = 48Vdc Load: $I_o = 0.67A$
 Ch 1: Vo Ch 3: $V_{ON/OFF}$

ELECTRICAL SPECIFICATIONS

ERM00C36 Performance Curves

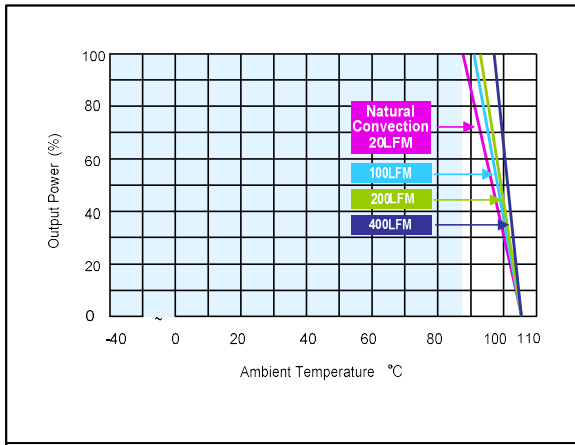

Figure 71: ERM00C36 Derating Output Current vs Ambient Temperature and Airflow (without heatsink)
 Vin = 48Vdc Load: Io = 0 to 0.67A

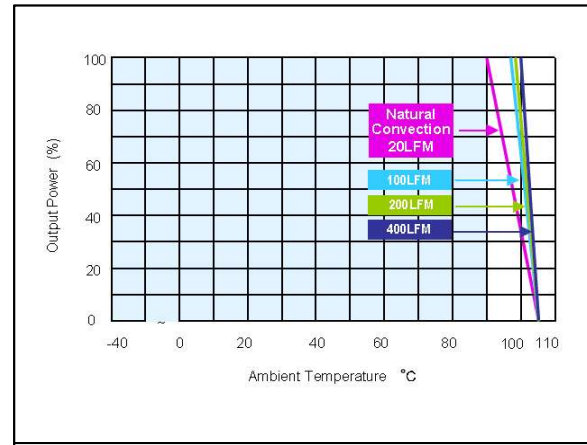

Figure 72: ERM00C36 Derating Output Current vs Ambient Temperature and Airflow (with heatsink)
 Vin = 48Vdc Load: Io = 0 to 0.67A

ELECTRICAL SPECIFICATIONS

ERM00H36 Performance Curves

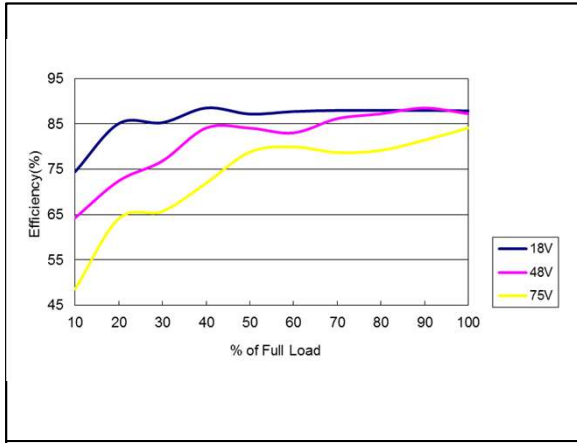

Figure 73: ERM00H36 Efficiency Versus Output Current Curve
 Vin = 18 to 75Vdc Load: $I_o = 0$ to 0.417A

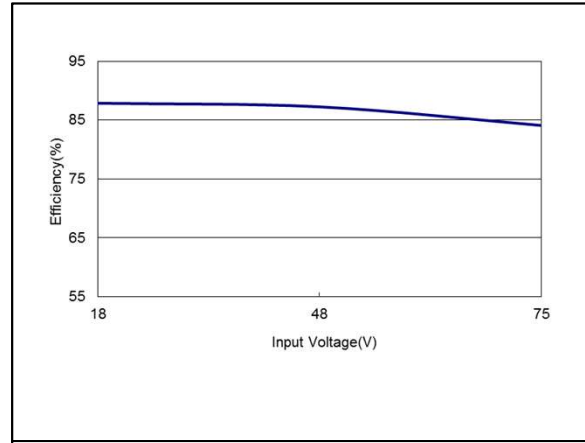

Figure 74: ERM00H36 Efficiency Versus Input Voltage Curve
 Vin = 18 to 75Vdc Load: $I_o = 0.417A$

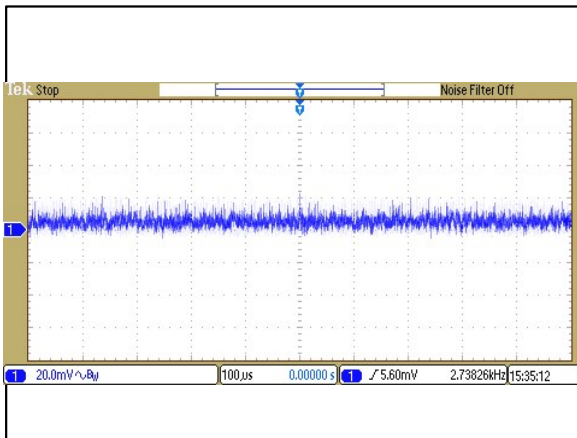

Figure 75: ERM00H36 Ripple and Noise Measurement
 Vin = 48Vdc Load: $I_o = 0.417A$
 Ch 1: Vo

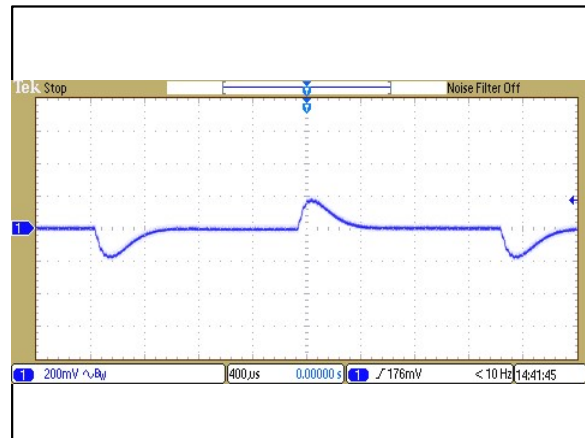

Figure 76: ERM00H36 Transient Response
 Vin = 48Vdc Load: $I_o = 100\%$ to 75% load change
 Ch 1: Vo

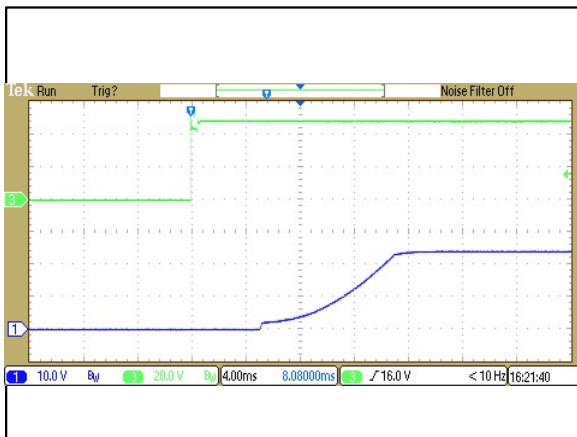

Figure 77: ERM00H36 Output Voltage Startup Characteristic by Vin
 Vin = 48Vdc Load: $I_o = 0.417A$
 Ch 1: Vo Ch 3: Vin

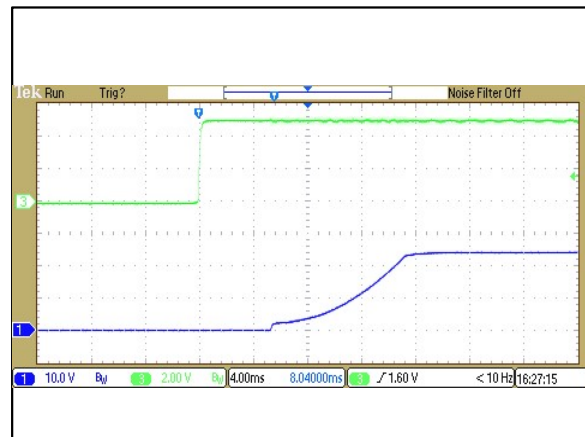

Figure 78: ERM00H36 Output Voltage Startup Characteristic by $V_{ON/OFF}$
 Vin = 48Vdc Load: $I_o = 0.417A$
 Ch 1: Vo Ch 3: $V_{ON/OFF}$

ELECTRICAL SPECIFICATIONS

ERM00H36 Performance Curves

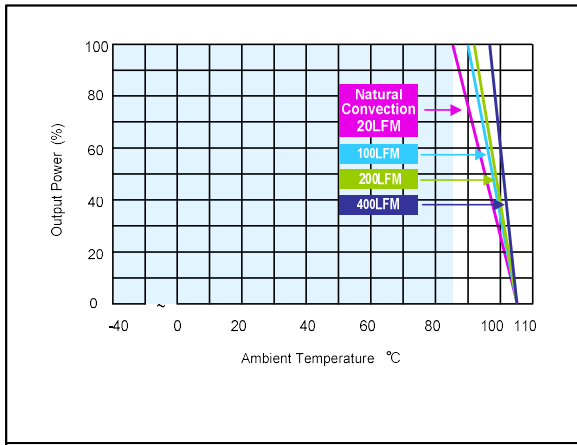

Figure 79: ERM00H36 Derating Output Current vs Ambient Temperature and Airflow (without heatsink)
 Vin = 48Vdc Load: Io = 0 to 0.417A

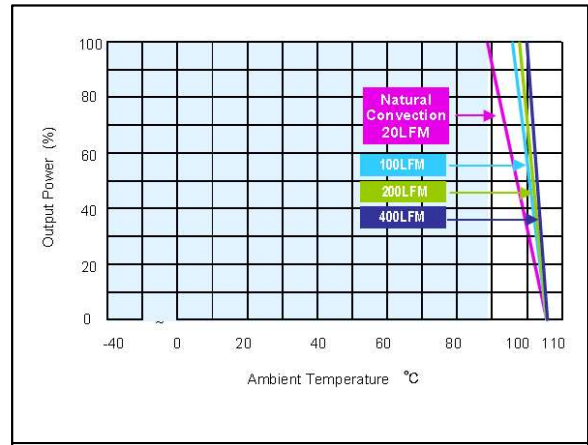

Figure 80: ERM00H36 Derating Output Current vs Ambient Temperature and Airflow (with heatsink)
 Vin = 48Vdc Load: Io = 0 to 0.417A

ELECTRICAL SPECIFICATIONS

ERM00BB36 Performance Curves

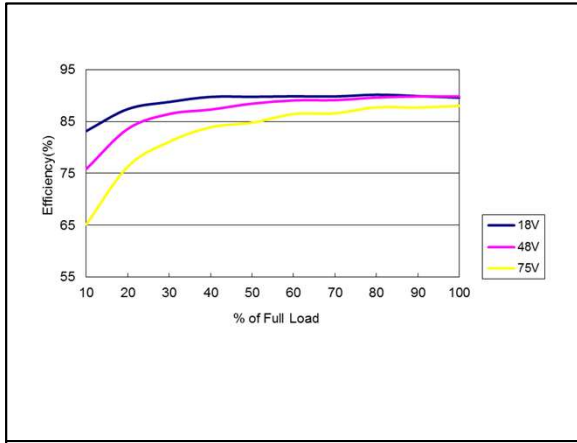

Figure 81: ERM00BB36 Efficiency Versus Output Current Curve
 Vin = 18 to 75Vdc Load: Io = 0 to ±0.417A

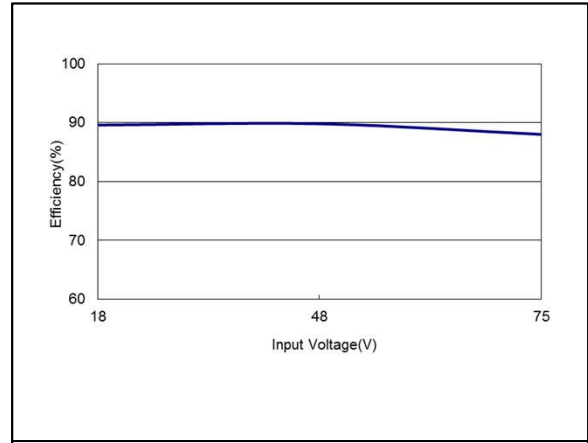

Figure 82: ERM00BB36 Efficiency Versus Input Voltage Curve
 Vin = 18 to 75Vdc Load: Io = ±0.417A

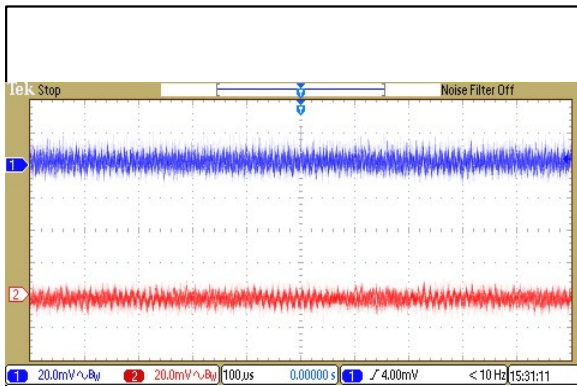

Figure 83: ERM00BB36 Ripple and Noise Measurement
 Vin = 48Vdc Load: Io = ±0.417A
 Ch 1: Vo1 Ch 2: Vo2

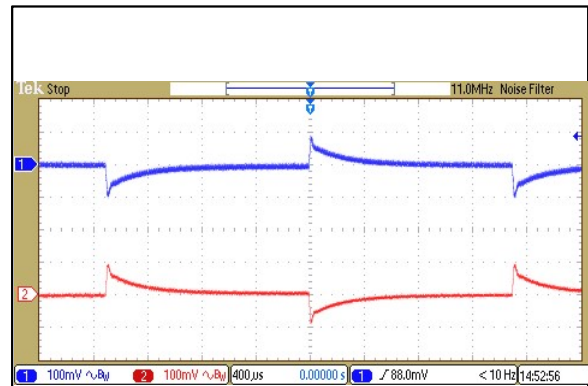

Figure 84: ERM00BB36 Transient Response
 Vin = 48Vdc Load: Io = 100% to 75% load change
 Ch 1: Vo1 Ch 2: Vo2

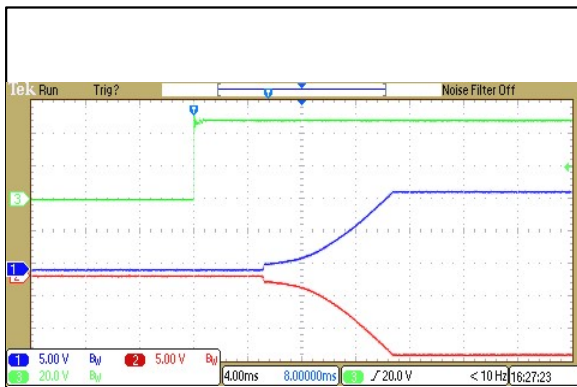

Figure 85: ERM00BB36 Output Voltage Startup Characteristic by Vin
 Vin = 48Vdc Load: Io = ±0.417A
 Ch 1: Vo1 Ch 2: Vo2 Ch 3: Vin

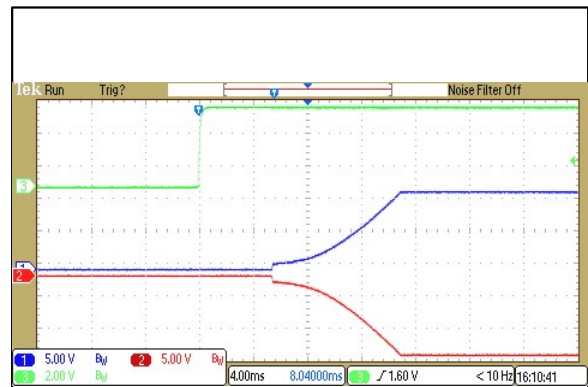

Figure 86: ERM00BB36 Output Voltage Startup Characteristic by VON/OFF
 Vin = 48Vdc Load: Io = ±0.417A
 Ch 1: Vo1 Ch 2: Vo2 Ch 3: VON/OFF

ELECTRICAL SPECIFICATIONS

ERM00BB36 Performance Curves

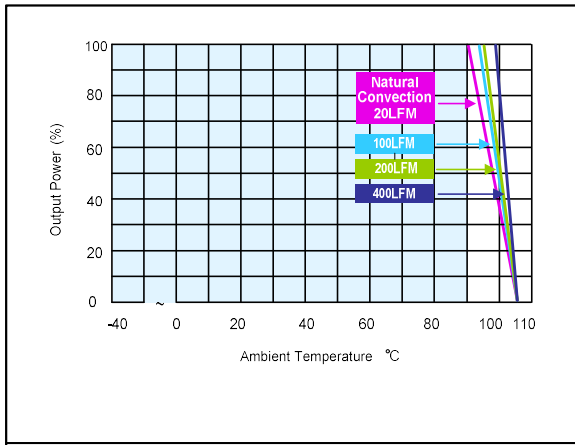

Figure 87: ERM00BB36 Derating Output Current vs Ambient Temperature and Airflow (without heatsink)
 Vin = 48Vdc Load: Io = 0 to ±0.417A

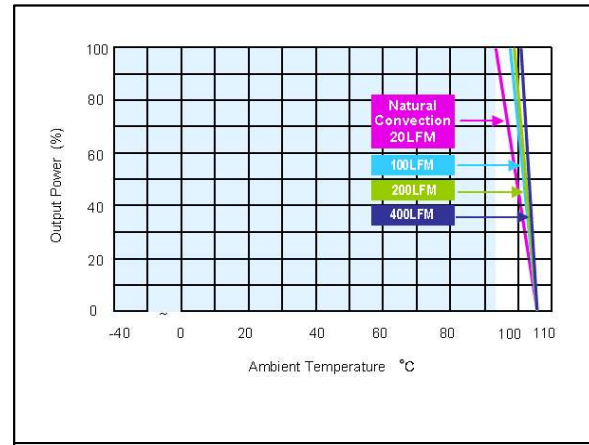

Figure 88: ERM00BB36 Derating Output Current vs Ambient Temperature and Airflow (with heatsink)
 Vin = 48Vdc Load: Io = 0 to ±0.417A

ELECTRICAL SPECIFICATIONS

ERM00CC36 Performance Curves

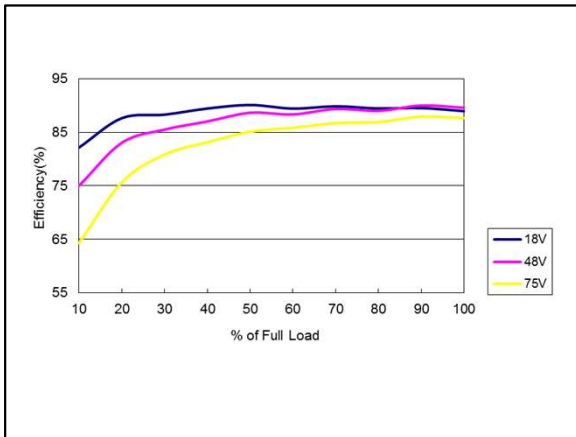

Figure 89: ERM00CC36 Efficiency Versus Output Current Curve
 Vin = 18 to 75Vdc Load: Io = 0 to ±0.335A

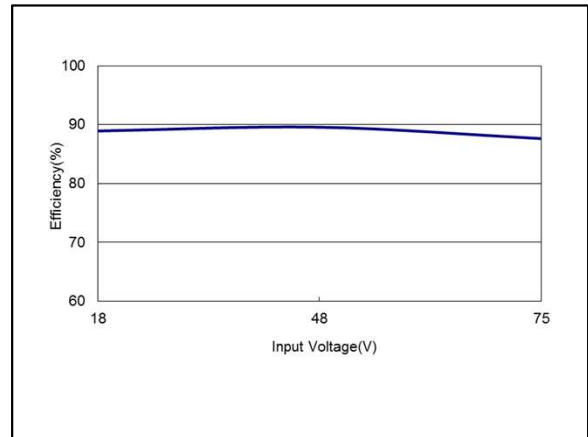

Figure 90: ERM00CC36 Efficiency Versus Input Voltage Curve
 Vin = 18 to 75Vdc Load: Io = ±0.335A

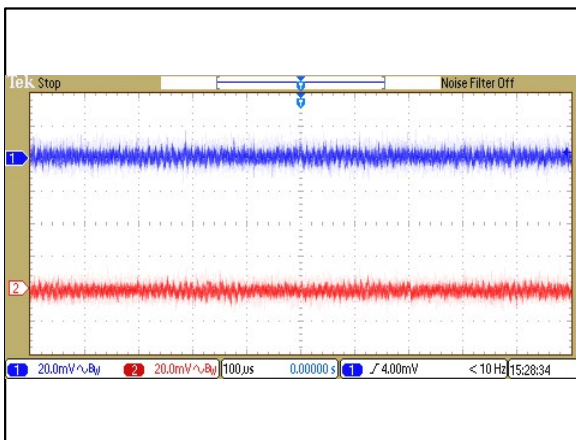

Figure 91: ERM00CC36 Ripple and Noise Measurement
 Vin = 48Vdc Load: Io = ±0.335A
 Ch 1: Vo1 Ch 2: Vo2

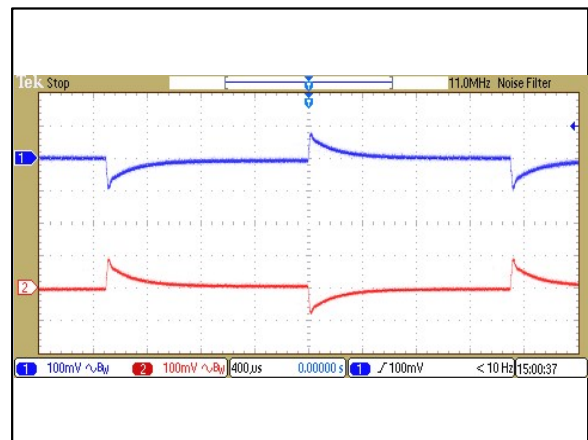

Figure 92: ERM00CC36 Transient Response
 Vin = 48Vdc Load: Io = 100% to 75% load change
 Ch 1: Vo1 Ch 2: Vo2

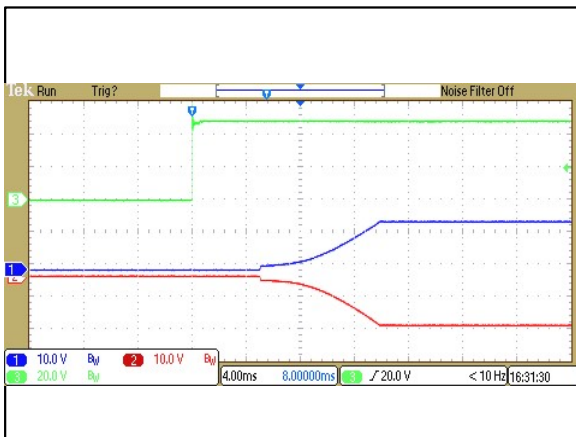

Figure 93: ERM00CC36 Output Voltage Startup Characteristic by Vin
 Vin = 48Vdc Load: Io = ±0.335A
 Ch 1: Vo1 Ch 2: Vo2 Ch 3: Vin

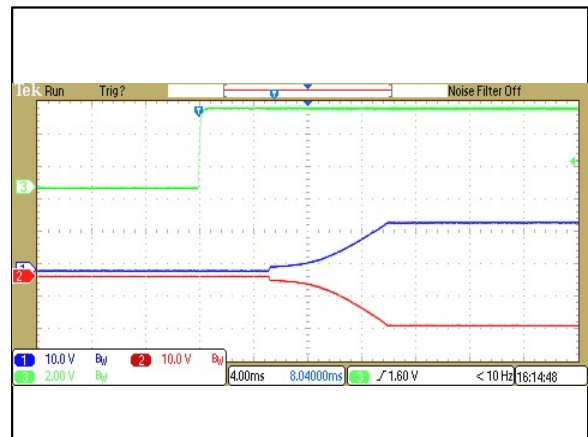

Figure 94: ERM00CC36 Output Voltage Startup Characteristic by VON/OFF
 Vin = 48Vdc Load: Io = ±0.335A
 Ch 1: Vo1 Ch 2: Vo2 Ch 3: VON/OFF

ELECTRICAL SPECIFICATIONS

ERM00CC36 Performance Curves

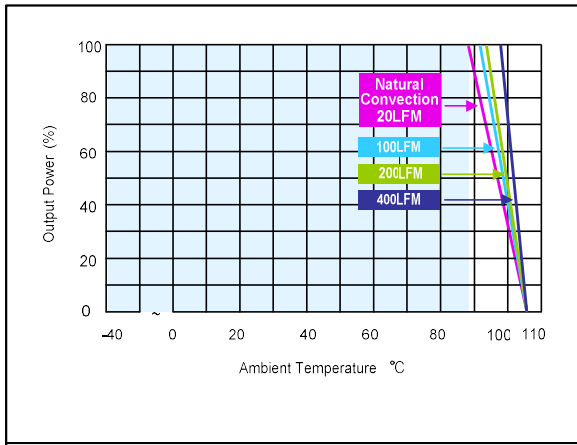

Figure 95: ERM00CC36 Derating Output Current vs Ambient Temperature and Airflow (without heatsink)
 Vin = 48Vdc Load: Io = 0 to ±0.335A

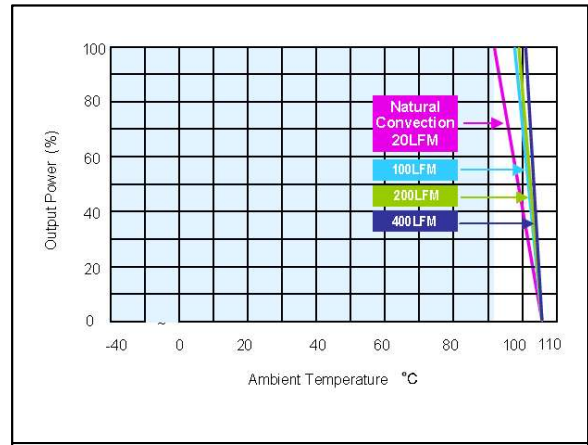

Figure 96: ERM00CC36 Derating Output Current vs Ambient Temperature and Airflow (with heatsink)
 Vin = 48Vdc Load: Io = 0 to ±0.335A

ELECTRICAL SPECIFICATIONS

ERM02A110 Performance Curves

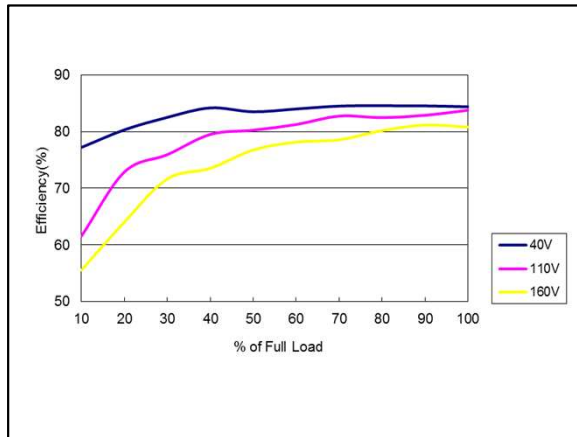

Figure 97: ERM02A110 Efficiency Versus Output Current Curve
 Vin = 40 to 160Vdc Load: Io = 0 to 0.835A

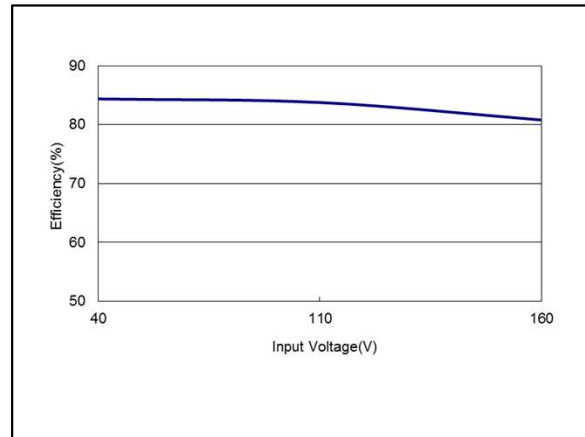

Figure 98: ERM02A110 Efficiency Versus Input Voltage Curve
 Vin = 40 to 160Vdc Load: Io = 0.835A

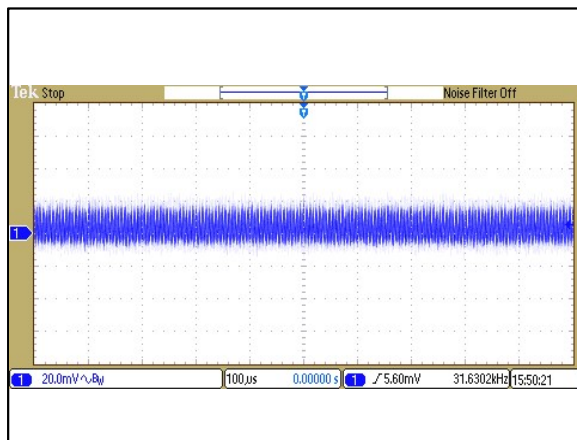

Figure 99: ERM02A110 Ripple and Noise Measurement
 Vin = 110Vdc Load: Io = 0.835A
 Ch 1: Vo

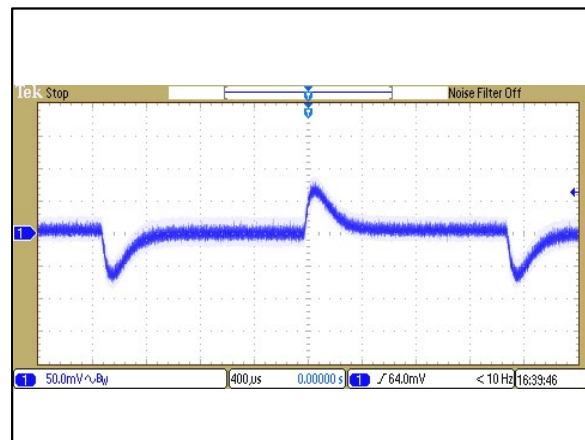

Figure 100: ERM02A110 Transient Response
 Vin = 110Vdc Load: Io = 100% to 75% load change
 Ch 1: Vo

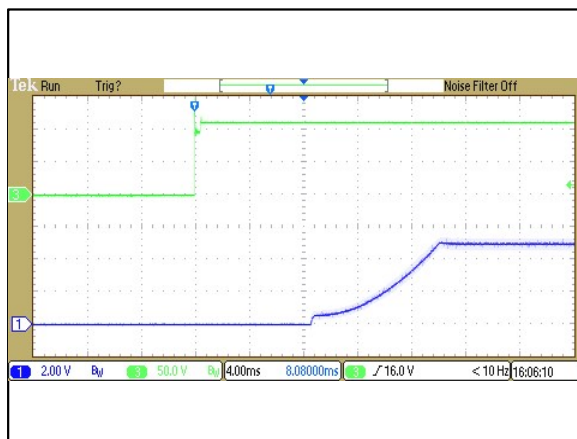

Figure 101: ERM02A110 Output Voltage Startup Characteristic by Vin
 Vin = 110Vdc Load: Io = 0.835A
 Ch 1: Vo Ch 3: Vin

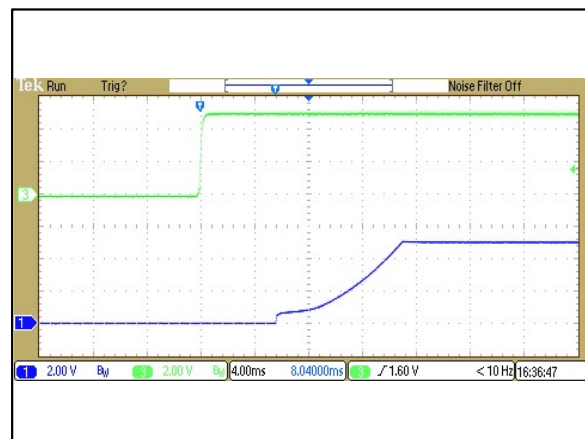

Figure 102: ERM02A110 Output Voltage Startup Characteristic by V_{ON/OFF}
 Vin = 110Vdc Load: Io = 0.835A
 Ch 1: Vo Ch 3: V_{ON/OFF}

ELECTRICAL SPECIFICATIONS

ERM02A110 Performance Curves

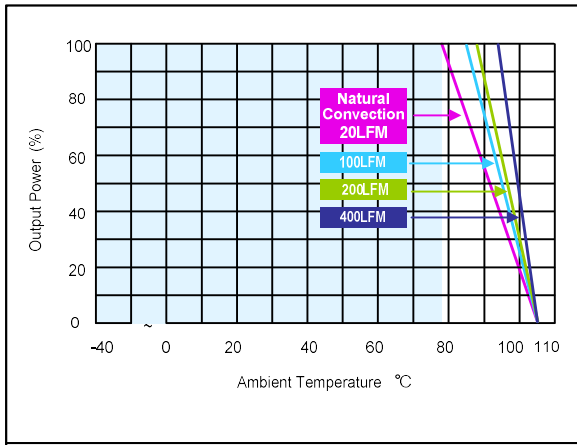

Figure 103: ERM02A110 Derating Output Current vs Ambient Temperature and Airflow (without heatsink)
 Vin = 110Vdc Load: Io = 0 to 0.835A

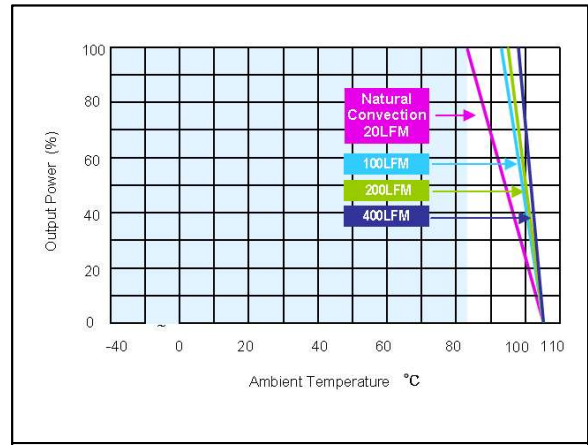

Figure 104: ERM02A110 Derating Output Current vs Ambient Temperature and Airflow (with heatsink)
 Vin = 110Vdc Load: Io = 0 to 0.835A

ELECTRICAL SPECIFICATIONS

ERM00B110 Performance Curves

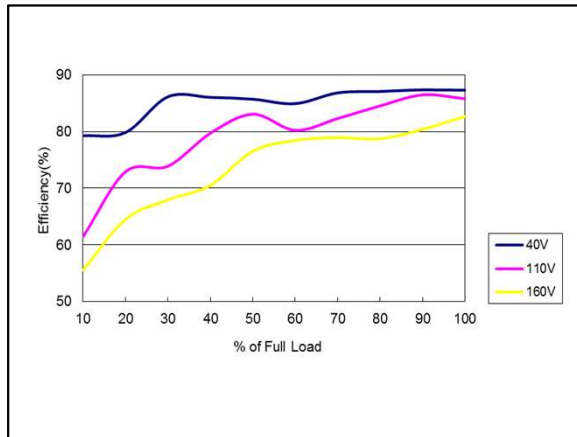

Figure 105: ERM00B110 Efficiency Versus Output Current Curve
 Vin = 40 to 160Vdc Load: Io = 0 to 0.83A

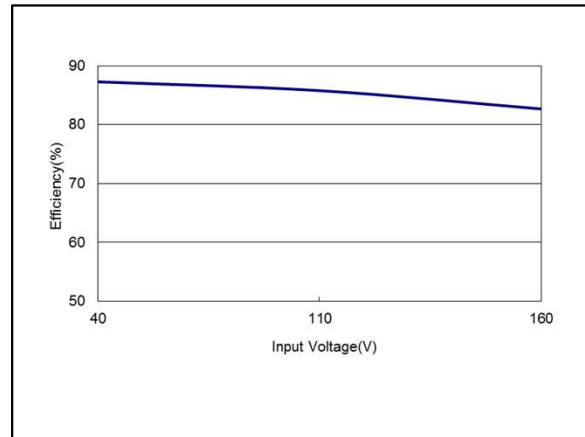

Figure 106: ERM00B110 Efficiency Versus Input Voltage Curve
 Vin = 40 to 160Vdc Load: Io = 0.83A

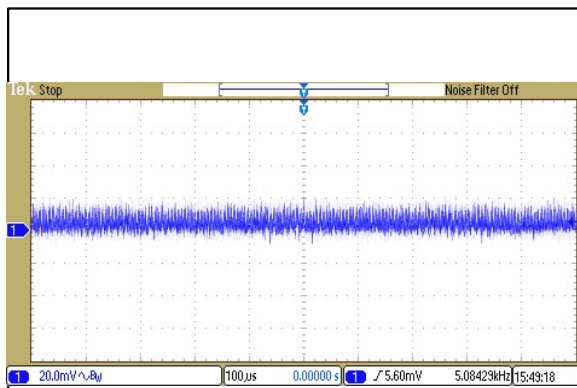

Figure 107: ERM00B110 Ripple and Noise Measurement
 Vin = 110Vdc Load: Io = 0.83A
 Ch 1: Vo

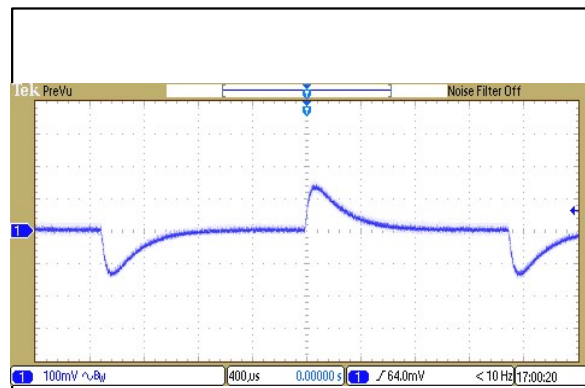

Figure 108: ERM00B110 Transient Response
 Vin = 110Vdc Load: Io = 100% to 75% load change
 Ch 1: Vo

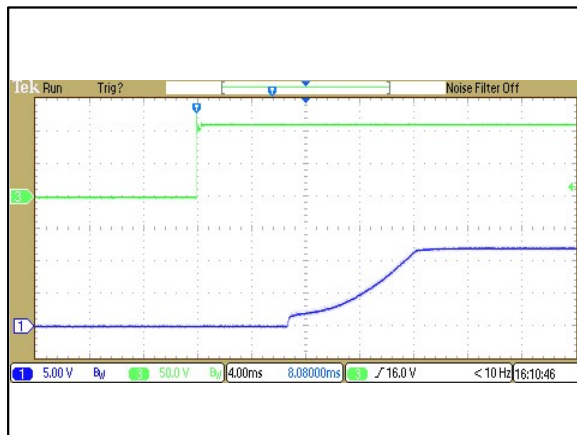

Figure 109: ERM00B110 Output Voltage Startup Characteristic by Vin
 Vin = 110Vdc Load: Io = 0.83A
 Ch 1: Vo Ch 3: Vin

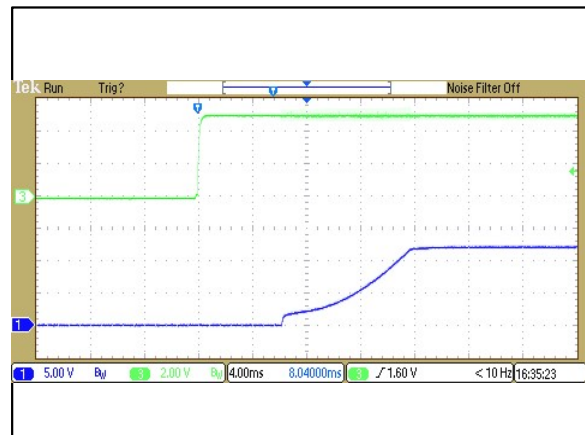

Figure 110: ERM00B110 Output Voltage Startup Characteristic by V_{ON/OFF}
 Vin = 110Vdc Load: Io = 0.83A
 Ch 1: Vo Ch 3: V_{ON/OFF}

ELECTRICAL SPECIFICATIONS

ERM00B110 Performance Curves

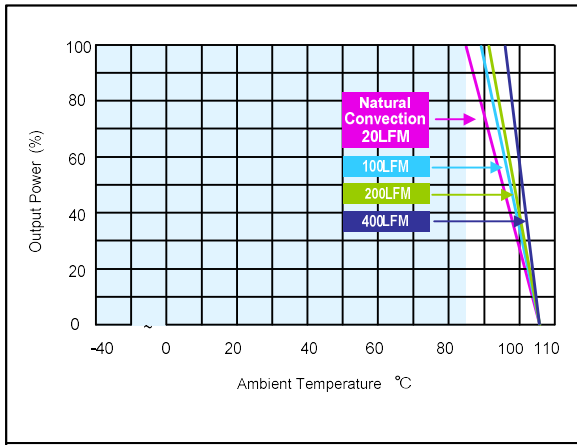

Figure 111: ERM00B110 Derating Output Current vs Ambient Temperature and Airflow (without heatsink)
 Vin = 110Vdc Load: Io = 0 to 0.83A

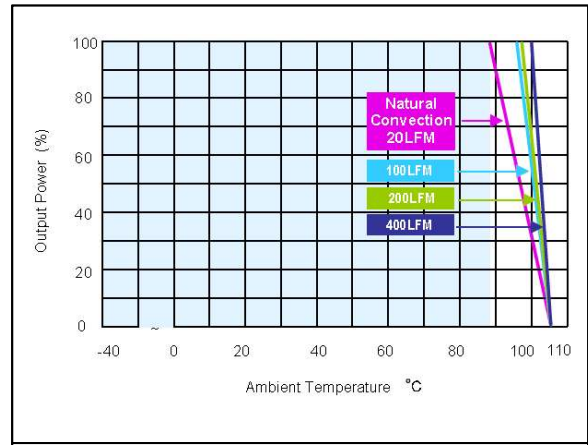

Figure 112: ERM00B110 Derating Output Current vs Ambient Temperature and Airflow (with heatsink)
 Vin = 110Vdc Load: Io = 0 to 0.83A

ELECTRICAL SPECIFICATIONS

ERM00C110 Performance Curves

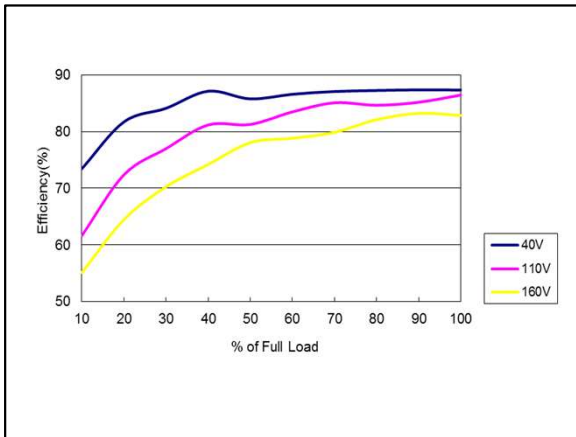

Figure 113: ERM00C110 Efficiency Versus Output Current Curve
 Vin = 40 to 160Vdc Load: Io = 0 to 0.417A

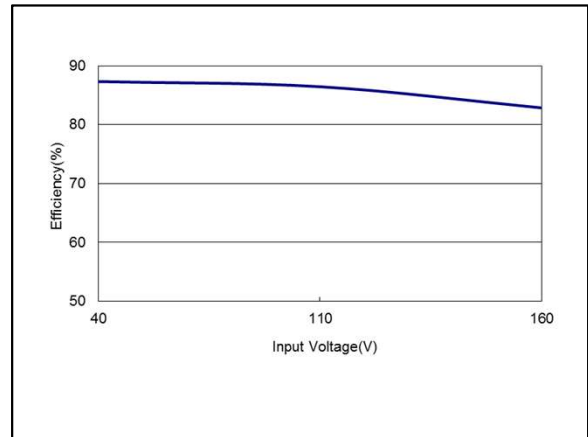

Figure 114: ERM00C110 Efficiency Versus Input Voltage Curve
 Vin = 40 to 160Vdc Load: Io = 0.417A

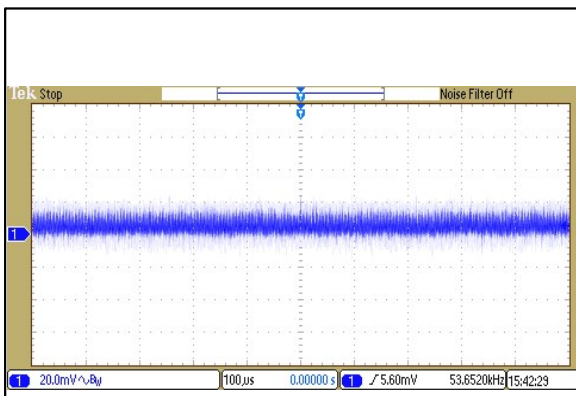

Figure 115: ERM00C110 Ripple and Noise Measurement
 Vin = 110Vdc Load: Io = 0.417A
 Ch 1: Vo

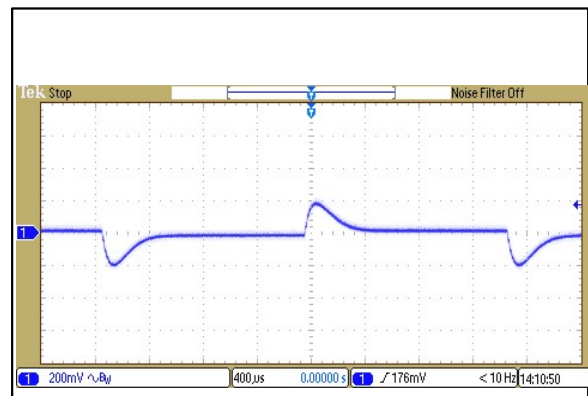

Figure 116: ERM00C110 Transient Response
 Vin = 110Vdc Load: Io = 100% to 75% load change
 Ch 1: Vo

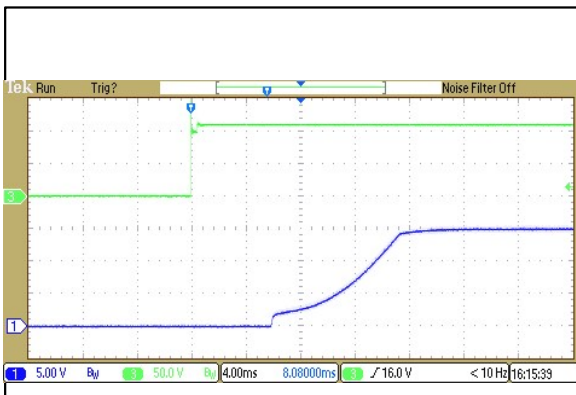

Figure 117: ERM00C110 Output Voltage Startup Characteristic by Vin
 Vin = 110Vdc Load: Io = 0.417A
 Ch 1: Vo Ch 3: Vin

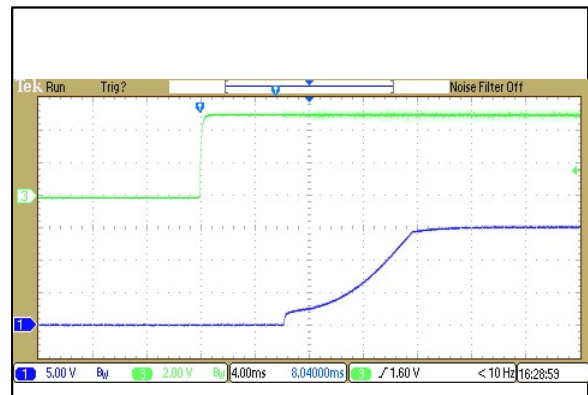

Figure 118: ERM00C110 Output Voltage Startup Characteristic by V_{ON/OFF}
 Vin = 110Vdc Load: Io = 0.417A
 Ch 1: Vo Ch 3: V_{ON/OFF}

ELECTRICAL SPECIFICATIONS

ERM00C110 Performance Curves

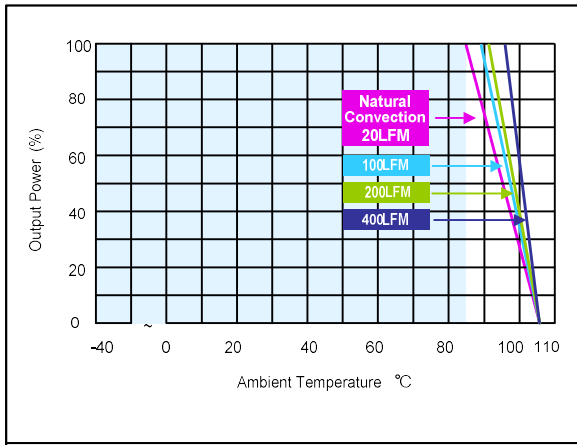

Figure 119: ERM00C110 Derating Output Current vs Ambient Temperature and Airflow (without heatsink)
 Vin = 110Vdc Load: Io = 0 to 0.417A

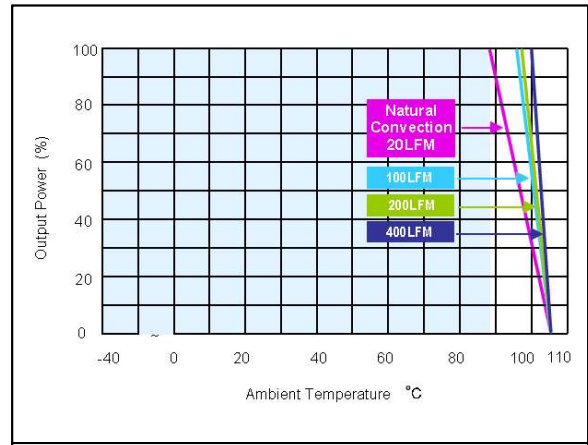

Figure 120: ERM00C110 Derating Output Current vs Ambient Temperature and Airflow (with heatsink)
 Vin = 110Vdc Load: Io = 0 to 0.417A

ELECTRICAL SPECIFICATIONS

ERM00H110 Performance Curves

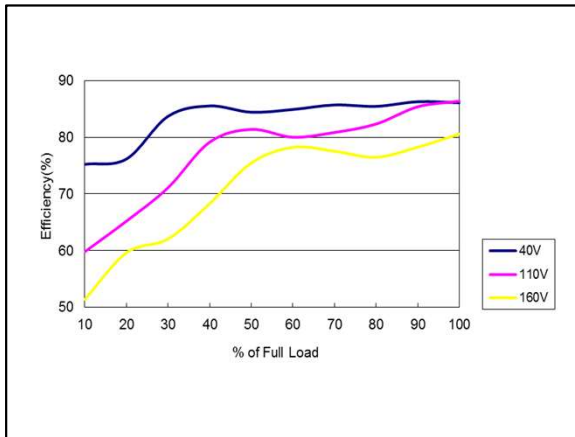

Figure 121: ERM00H110 Efficiency Versus Output Current Curve
 Vin = 40 to 160Vdc Load: Io = 0 to 0.417A

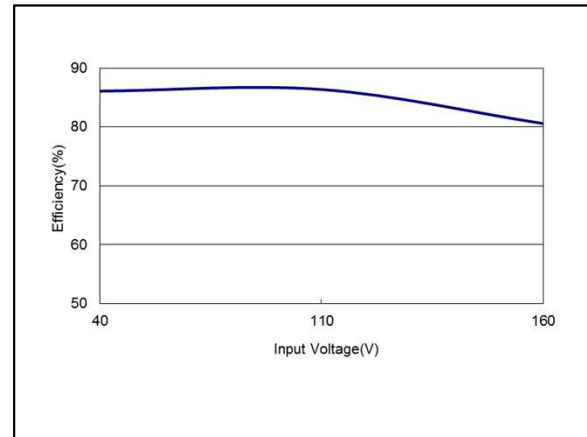

Figure 122: ERM00H110 Efficiency Versus Input Voltage Curve
 Vin = 40 to 160Vdc Load: Io = 0.417A

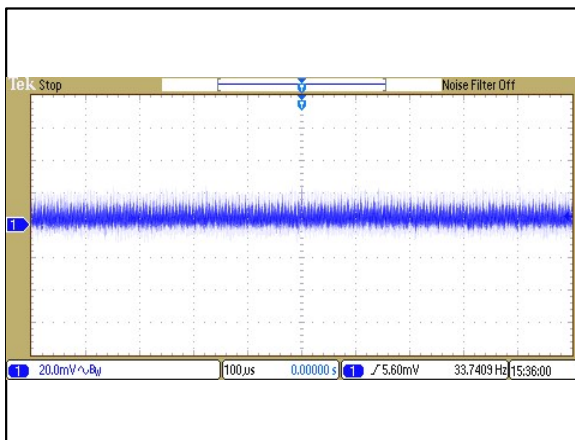

Figure 123: ERM00H110 Ripple and Noise Measurement
 Vin = 110Vdc Load: Io = 0.417A
 Ch 1: Vo

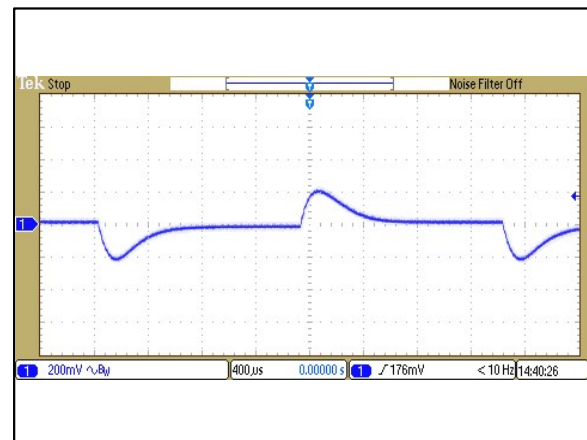

Figure 124: ERM00H110 Transient Response
 Vin = 110Vdc Load: Io = 100% to 75% load change
 Ch 1: Vo

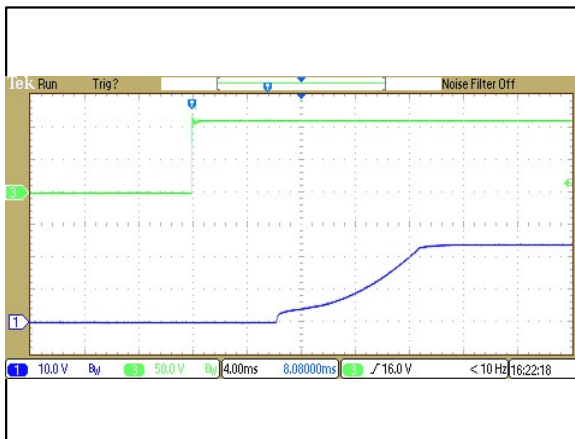

Figure 125: ERM00H110 Output Voltage Startup Characteristic by Vin
 Vin = 110Vdc Load: Io = 0.417A
 Ch 1: Vo Ch 3: Vin

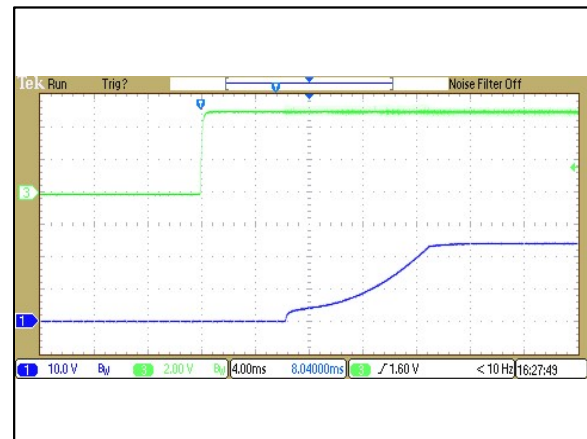

Figure 126: ERM00H110 Output Voltage Startup Characteristic by V_{ON/OFF}
 Vin = 110Vdc Load: Io = 0.417A
 Ch 1: Vo Ch 3: V_{ON/OFF}

ELECTRICAL SPECIFICATIONS

ERM00H110 Performance Curves

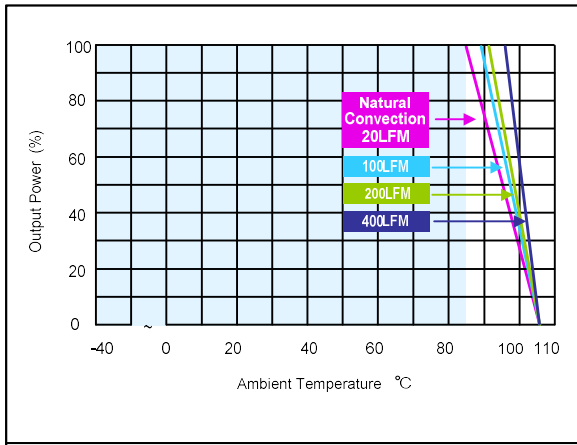

Figure 127: ERM00H110 Derating Output Current vs Ambient Temperature and Airflow (without heatsink)
 Vin = 110Vdc Load: Io = 0 to 0.417A

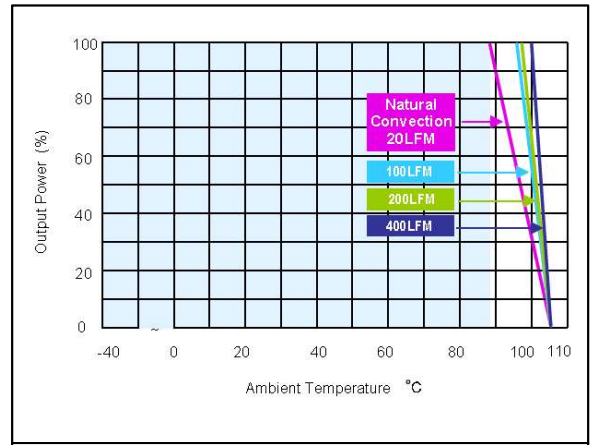

Figure 128: ERM00H110 Derating Output Current vs Ambient Temperature and Airflow (with heatsink)
 Vin = 110Vdc Load: Io = 0 to 0.417A

ELECTRICAL SPECIFICATIONS

ERM00BB110 Performance Curves

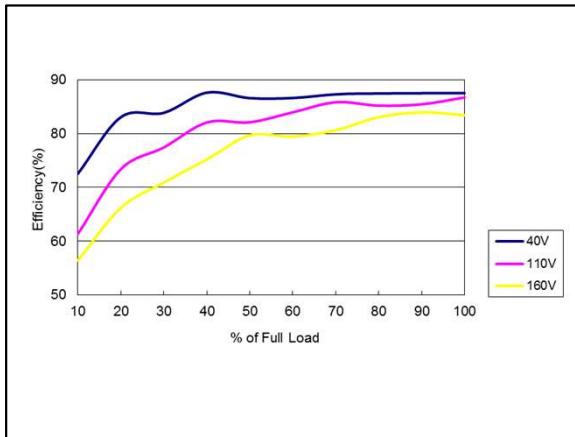

Figure 129: ERM00BB110 Efficiency Versus Output Current Curve
 Vin = 40 to 160Vdc Load: Io = 0 to ±0.417A

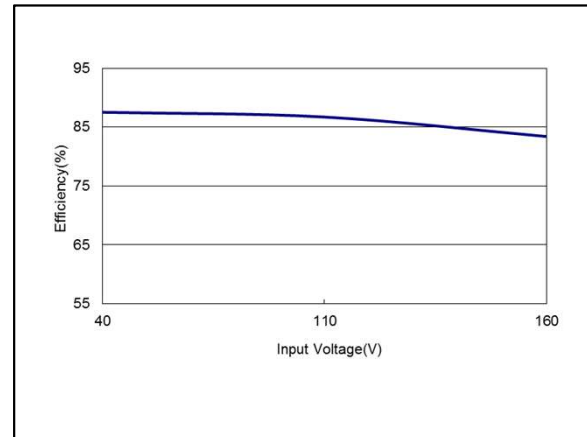

Figure 130: ERM00BB110 Efficiency Versus Input Voltage Curve
 Vin = 40 to 160Vdc Load: Io = ±0.417A

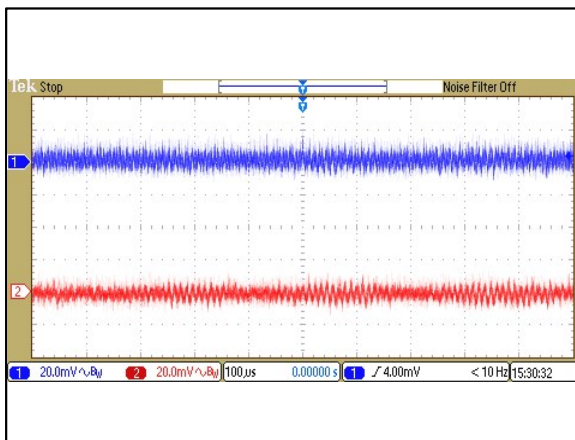

Figure 131: ERM00BB110 Ripple and Noise Measurement
 Vin = 110Vdc Load: Io = ±0.417A
 Ch 1: Vo1 Ch 2: Vo2

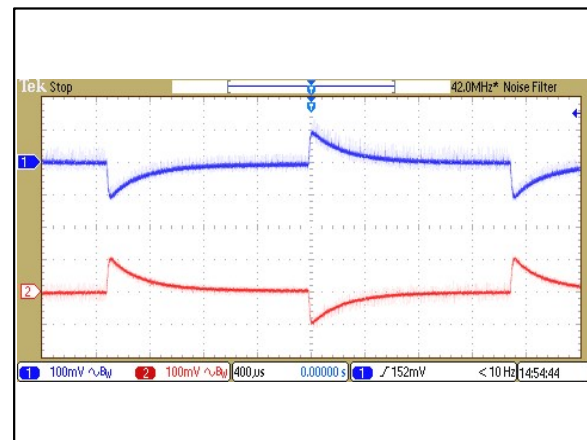

Figure 132: ERM00BB110 Transient Response
 Vin = 110Vdc Load: Io = 100% to 75% load change
 Ch 1: Vo1 Ch 2: Vo2

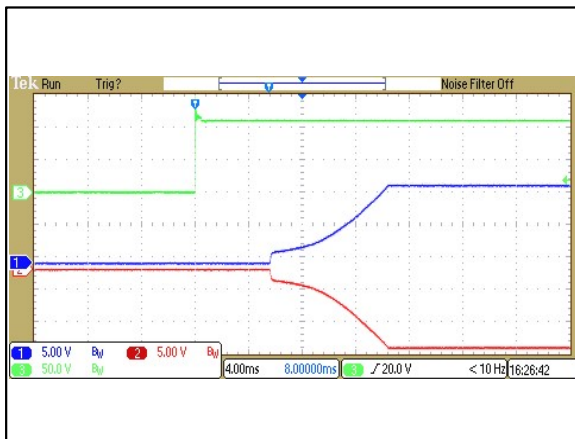

Figure 133: ERM00BB110 Output Voltage Startup Characteristic by Vin
 Vin = 110Vdc Load: Io = ±0.417A
 Ch 1: Vo1 Ch 2: Vo2 Ch 3: Vin

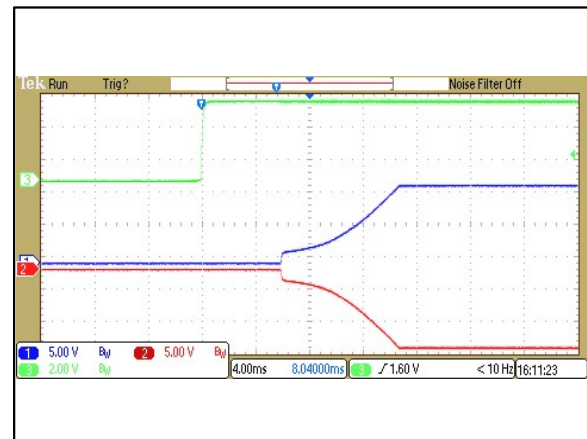

Figure 134: ERM00BB110 Output Voltage Startup Characteristic by V_{ON/OFF}
 Vin = 110Vdc Load: Io = ±0.417
 Ch 1: Vo1 Ch 2: Vo2 Ch 3: V_{ON/OFF}

ELECTRICAL SPECIFICATIONS

ERM00BB110 Performance Curves

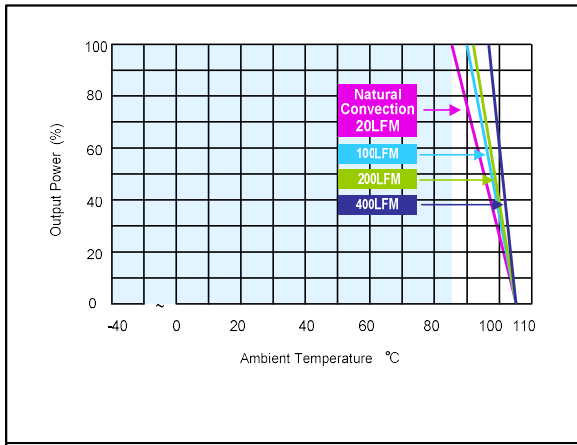

Figure 135: ERM00BB110 Derating Output Current vs Ambient Temperature and Airflow (without heatsink)
 Vin = 110Vdc Load: Io = 0 to ±0.417A

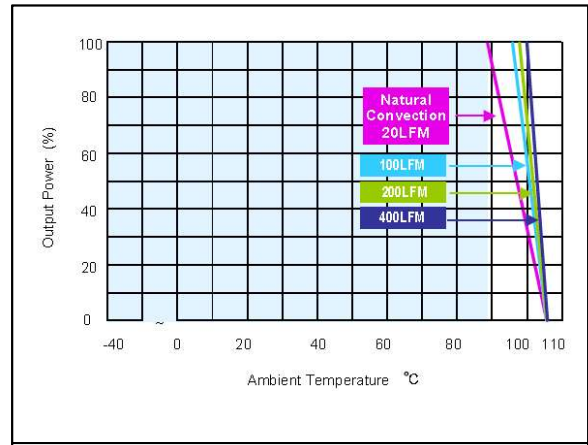

Figure 136: ERM00BB110 Derating Output Current vs Ambient Temperature and Airflow (with heatsink)
 Vin = 110Vdc Load: Io = 0 to ±0.417A

ELECTRICAL SPECIFICATIONS

ERM00CC110 Performance Curves

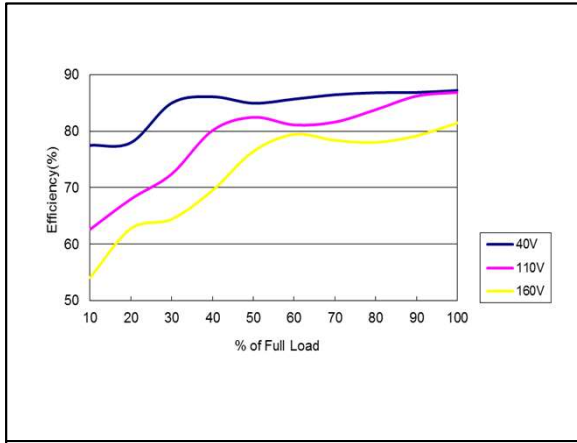

Figure 137: ERM00CC110 Efficiency Versus Output Current Curve
 Vin = 40 to 160Vdc Load: Io = 0 to ±0.335A

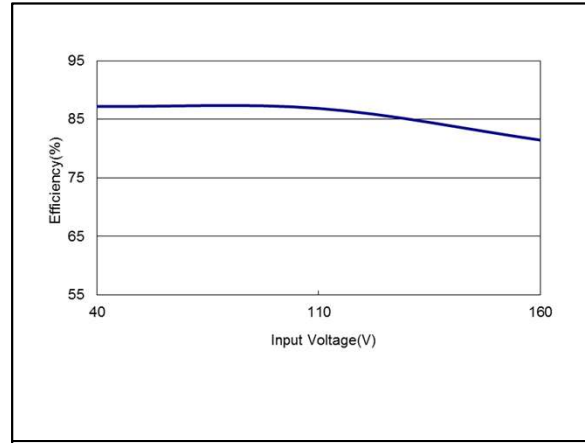

Figure 138: ERM00CC110 Efficiency Versus Input Voltage Curve
 Vin = 40 to 160Vdc Load: Io = ±0.335A

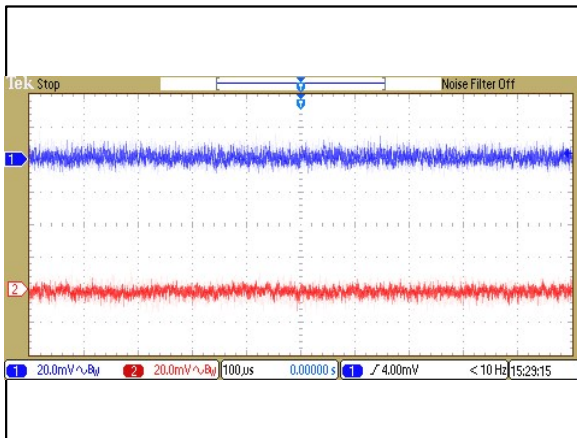

Figure 139: ERM00CC110 Ripple and Noise Measurement
 Vin = 110Vdc Load: Io = ±0.335A
 Ch 1: Vo1 Ch 2: Vo2

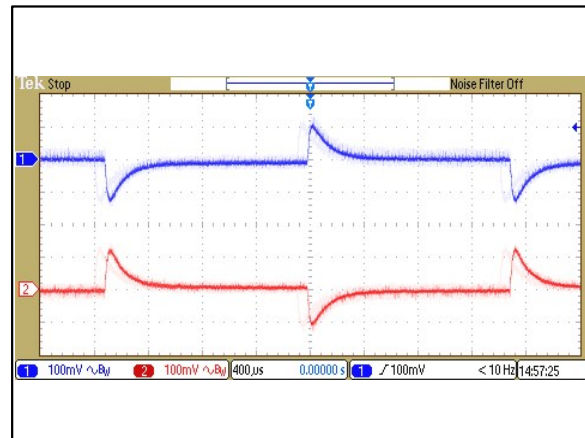

Figure 140: ERM00CC110 Transient Response
 Vin = 110Vdc Load: Io = 100% to 75% load change
 Ch 1: Vo1 Ch 2: Vo2

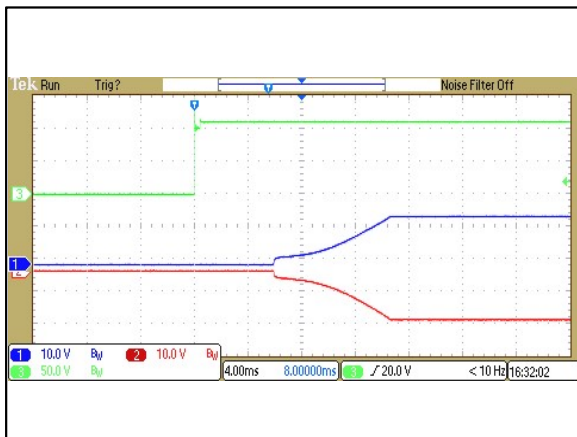

Figure 141: ERM00CC110 Output Voltage Startup Characteristic by Vin
 Vin = 110Vdc Load: Io = ±0.335A
 Ch 1: Vo1 Ch 2: Vo2 Ch 3: Vin

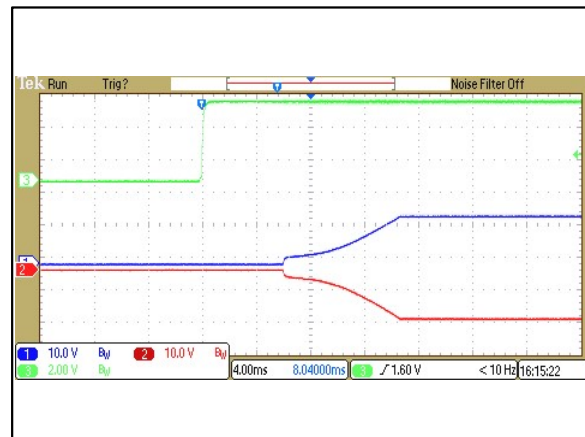

Figure 142: ERM00CC110 Output Voltage Startup Characteristic by VON/OFF
 Vin = 110Vdc Load: Io = ±0.335A
 Ch 1: Vo1 Ch 2: Vo2 Ch 3: VON/OFF

ELECTRICAL SPECIFICATIONS

ERM00CC110 Performance Curves

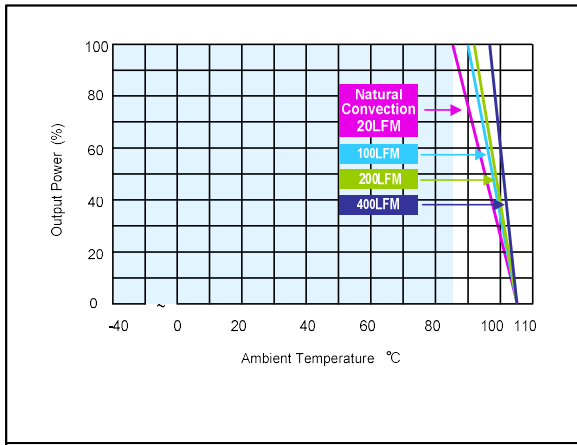

Figure 143: ERM00CC110 Derating Output Current vs Ambient Temperature and Airflow (without heatsink)
 Vin = 110Vdc Load: Io = 0 to ±0.335A

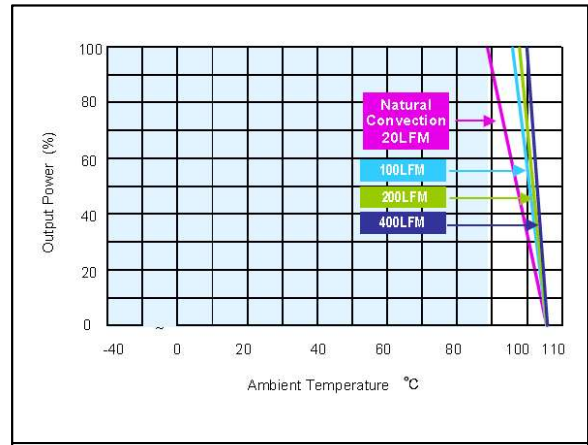
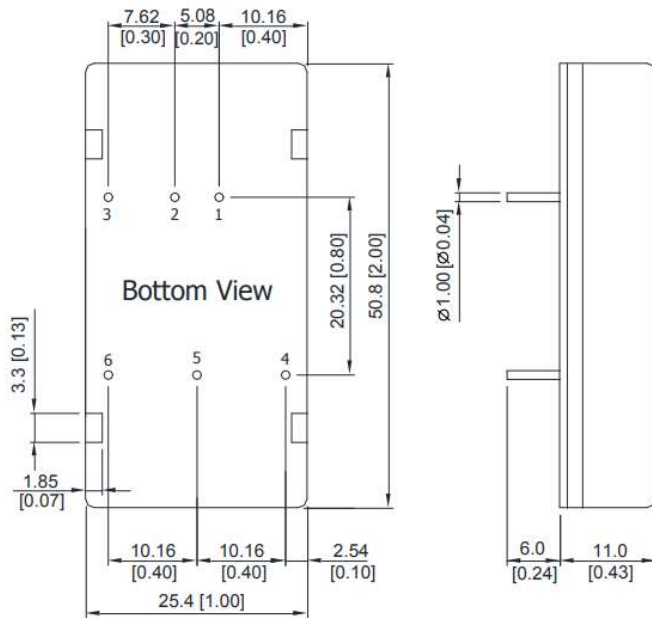

Figure 144: ERM00CC110 Derating Output Current vs Ambient Temperature and Airflow (with heatsink)
 Vin = 110Vdc Load: Io = 0 to ±0.335A

MECHANICAL SPECIFICATIONS

Mechanical Outlines - Without Heatsink

ERMxxxxx Models



Pin Connections		
Pin	Single Output	Dual Output
1	+Vin	+Vin
2	-Vin	-Vin
3	Remote On/Off	Remote On/Off
4	+Vout	+Vout
5	Trim	Common
6	-Vout	-Vout

ERMxxxxxB Models

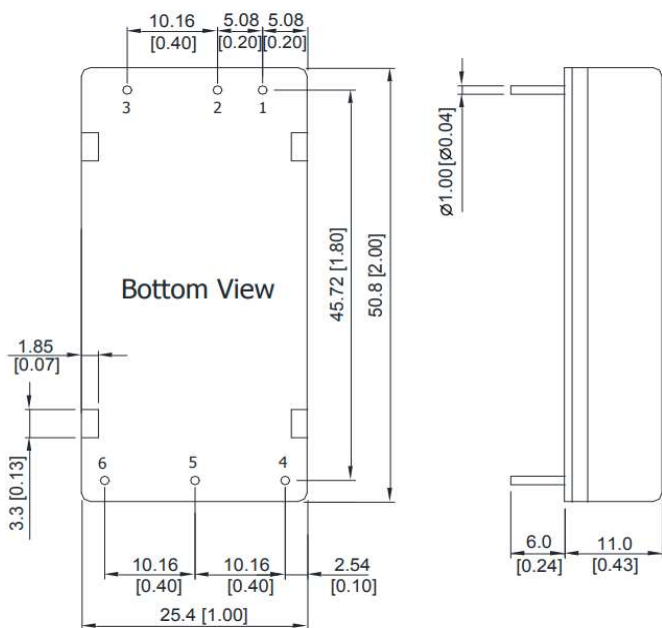

Pin Connections		
Pin	Single Output	Dual Output
1	+Vin	+Vin
2	-Vin	-Vin
3	Remote On/Off	Remote On/Off
4	+Vout	+Vout
5	-Vout	Common
6	Trim	-Vout

Note:

1. All dimensions in mm (inches)
2. Tolerance: $X.X \pm 0.75$ ($X.XX \pm 0.03$)
 $X.XX \pm 0.25$ ($X.XXX \pm 0.01$)
3. Pin diameter: 1.0 ± 0.05 (0.04 ± 0.002)

MECHANICAL SPECIFICATIONS

Mechanical Outlines - With Heatsink

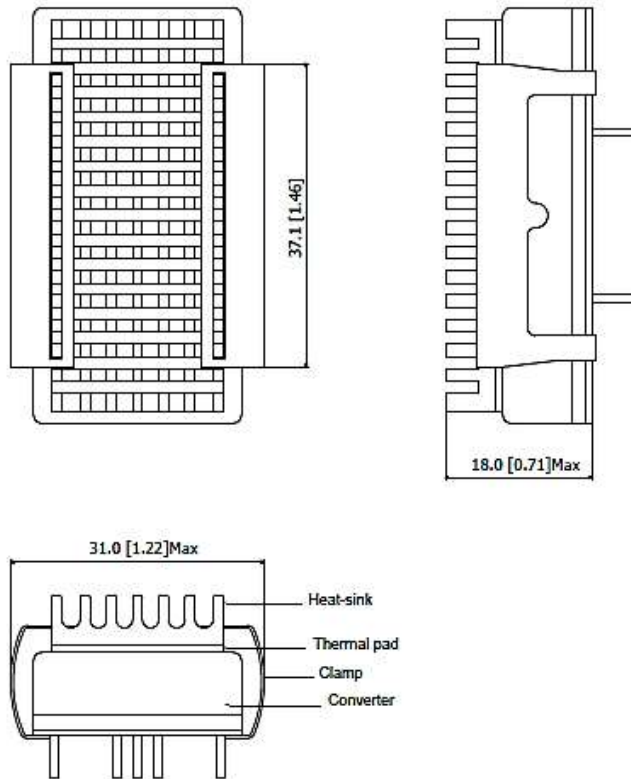

Note:
 1. All dimensions in mm (inches)
 2. Tolerance: $X.X \pm 0.75$ ($X.XX \pm 0.03$)
 $X.XX \pm 0.25$ ($X.XXX \pm 0.01$)
 3. Pin diameter 1.0 ± 0.05 (0.04 ± 0.002)

Physical Characteristics

Heatsink Size	37.1x31.0x18.0 mm (1.46x1.22x0.71 inches)
Heatsink Material	Aluminum
Finish	Black Anodized coating
Weight	9.0g

The advantages of adding a heatsink are:

1. To improve heat dissipation and increase the stability and reliability of the DC/DC converters at high operating temperatures.
2. To increase Operating temperature of the DC/DC converter, please refer to Derating Curve.

MECHANICAL SPECIFICATIONS

Physical Characteristics

Case Size	50.8x25.4x11.0mm (2.0x1.0x0.43 inches)
Case Material	Red Copper, Powder Coating
Base Material	FR4 PCB (flammability to UL 94V-0 rated)
Insulated Frame Material	Non-Conductive Black Plastic (flammability to UL 94V-0 rated)
Pin Material	Tinned Copper
Potting Material	Epoxy (flammability to UL 94V-0 rated)
Weight	40.5g

Recommended Pad Layout for Single & Dual Output Converter

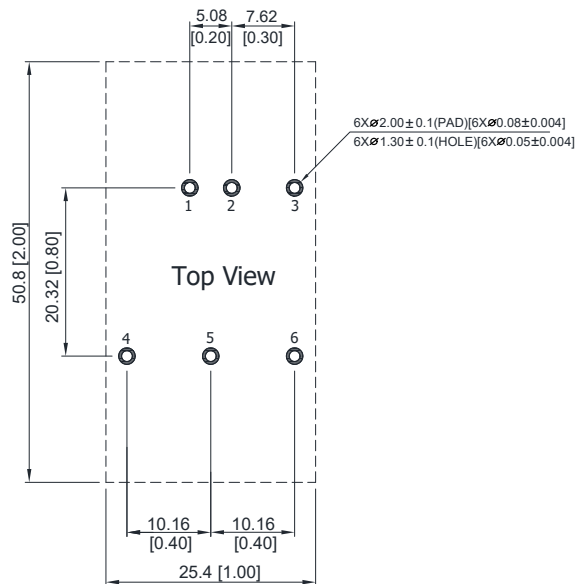

ENVIRONMENTAL SPECIFICATIONS

EMC Immunity

ERM 10W series power supply is designed to meet the following EMC immunity specifications.

Table 4. EMC Specifications			
Parameter	Standards & Level		Performance
General	Compliance with EN 50121-3-2 Railway Applications		
EMI	Conduction	EN55022, EN55032, FCC part15	Class A
EMS	EN55024		
	ESD	EN61000-4-2 Air $\pm 8\text{kV}$, Contact $\pm 6\text{kV}$	Criteria A
	Radiated immunity	EN61000-4-3 10V/m	
	Fast transient ⁴	EN61000-4-4 $\pm 2\text{KV}$	Criteria A
	Surge ⁴	EN61000-4-5 $\pm 1\text{KV}$	Criteria A
	Conducted immunity	EN61000-4-6 10Vrms	Criteria A
	PFMF	EN61000-4-8 3A/M	Criteria A

Note 1 - Specifications typical at $T_a=+25\text{ }^\circ\text{C}$, resistive load, nominal input voltage and rated output current unless otherwise noted.

Note 2 - We recommend to protect the converter by a slow blow fuse in the input supply line.

Note 3 - Other input and output voltage may be available, please contact factory.

Note 4 - To meet EN61000-4-4 & EN61000-4-5 an external capacitor across the input pins is required.

Suggested capacitor: 24XXX: CHEMI-CON KY Series 390 μF /63V.

48XXX: CHEMI-CON KY Series 330 μF /100V.

110XXX: CHEMI-CON KXG Series 220 μF /250V.

Note 5 - That "natural convection" is about 20LFM but is not equal to still air (0 LFM).

Note 6 - Specifications are subject to change without notice.

ENVIRONMENTAL SPECIFICATIONS

Safety Certifications

The ERM 10W series power supply is intended for inclusion in other equipment and the installer must ensure that it is in compliance with all the requirements of the end application. This product is only for inclusion by professional installers within other equipment and must not be operated as a stand alone product.

Table 5. Safety Certifications for ERM 10W series power supply system	
Document	Description
cUL/UL 60950-1(UL certificate)	US and Canada Requirements
IEC/EN 60950-1(CB-scheme)	European Requirements(All CENELEC Countries)
cUL/UL 62368-1(UL certificate)	US Requirements
IEC/EN 62368-1(CB-scheme)	European Requirements(All CENELEC Countries)
CE Mark	

ENVIRONMENTAL SPECIFICATIONS

Operating Temperature

Table 6. Operating Temperature					
Parameter	Model / Condition	Min	Max		Unit
			Without Heatsink	With Heatsink	
Operating Ambient Temperature Range Natural Convection Nominal Vin, Load 100% Inom. (for Power Derating see relative Derating Curves)	ERM00BB36	-40	90	93	°C
	ERM00H18 ERM00CC36		88	92	
	ERM00C18 ERM00B36 ERM00B36 ERM00CC18		87	90	
	ERM00B18 ERM00H36 ERM00BB18 ERM00BB110 ERM00CC110		85	89	
	ERM02A36 ERM00B110 ERM00C110 ERM00H110		84	88	
	ERM02A18		82	86	
	ERM02A110		78	83	
Thermal Impedance	Natural Convection without Heatsink	12.1	-		°C/W
	Natural Convection with Heatsink	9.8	-		
	100LFM Convection without Heatsink	9.2	-		
	100LFM Convection with Heatsink	5.4	-		
	200LFM Convection without Heatsink	7.8	-		
	200LFM Convection with Heatsink	4.5	-		
	400LFM Convection without Heatsink	5.2	-		
	400LFM Convection with Heatsink	3.0	-		
Case Temperature	All	-	+105		°C
Storage Temperature Range	All	-50	+125		°C
Lead Temperature	All	-	+260		°C
Operating Case Temperature	All	-	+95		°C

ENVIRONMENTAL SPECIFICATIONS

MTBF and Reliability

The MTBF of ERM 10W series of DC/DC converters has been calculated using MIL-HDBK 217F NOTICE2, Operating Temperature 25 °C, Ground Benign.

Model	MTBF	Unit
ERM02A18	3,283,987	Hours
ERM00B18	3,801,659	
ERM00C18	4,022,109	
ERM00H18	4,096,482	
ERM00BB18	3,538,719	
ERM00CC18	3,755,590	
ERM02A36	3,477,271	
ERM00B36	3,752,189	
ERM00C36	3,869,348	
ERM00H36	3,787,775	
ERM00BB36	4,002,475	
ERM00CC36	3,892,750	
ERM02A110	2,845,385	
ERM00B110	3,480,116	
ERM00C110	3,634,513	
ERM00H110	3,616,570	
ERM00BB110	3,694,350	
ERM00CC110	3,574,791	

APPLICATION NOTES

Peak-to-Peak Output Noise Measurement Test

Use a $1\mu\text{F}$ ceramic capacitor and a $10\mu\text{F}$ tantalum capacitor. Scope measurement should be made by using a BNC socket, measurement bandwidth is 0-20 MHz. Position the load between 50 mm and 75 mm from the DC/DC Converter.

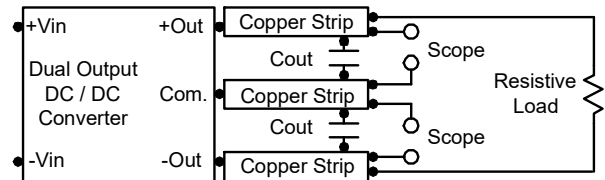
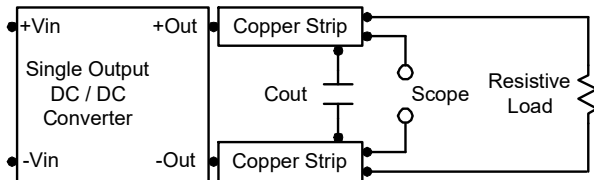

Output Ripple Reduction

A good quality low ESR capacitor placed as close as practicable across the load will give the best ripple and noise performance. To reduce output ripple, it is recommended to use $4.7\mu\text{F}$ capacitors at the output.

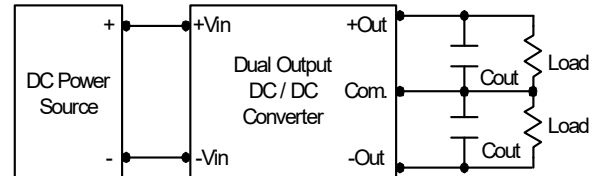
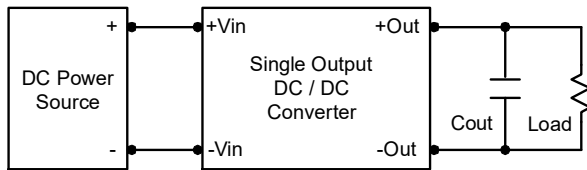

Input Source Impedance

The power module should be connected to a low ac-impedance input source. Highly inductive source impedances can affect the stability of the power module. In applications where power is supplied over long lines and output loading is high, it may be necessary to use a capacitor at the input to ensure startup. Capacitor mounted close to the power module helps ensure stability of the unit, it is recommended to use a good quality low Equivalent Series Resistance ($\text{ESR} < 1.0\Omega$ at 100 KHz) capacitor of $4.7\mu\text{F}$ for the 24V input devices, a $2.2\mu\text{F}$ for the 48V devices and a $1\mu\text{F}$ for the 110V devices.

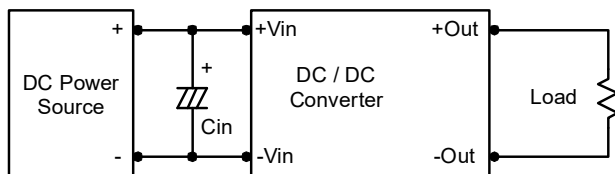

APPLICATION NOTES

Output Over Current Protection

To provide hiccup mode protection in a fault (output overload) condition, the unit is equipped with internal current limiting circuitry and can endure overload for an unlimited duration.

Output Over Voltage Protection

The output overvoltage clamp consists of control circuitry, which is independent of the primary regulation loop, that monitors the voltage on the output terminals.

The control loop of the clamp has a higher voltage set point than the primary loop. This provides a redundant voltage control that reduces the risk of output overvoltage. The OVP level can be found in Table 3.

Maximum Capacitive Load

The ERM 10W series has limitation of maximum connected capacitance at the output. The power module may be operated in current limiting mode during start-up, affecting the ramp-up and the startup time. The maximum capacitance can be found in Table 3.

Thermal Considerations

Many conditions affect the thermal performance of the power module, such as orientation, airflow over the module and board spacing. To avoid exceeding the maximum temperature rating of the components inside the power module, the case temperature must be kept below 105°C. The derating curves are determined from measurements obtained in a test setup.

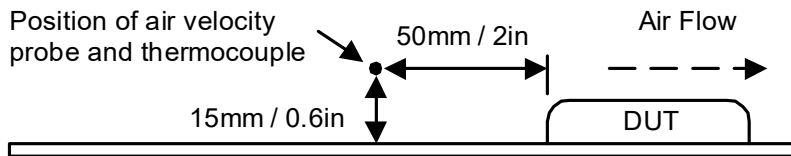

APPLICATION NOTES

Remote ON/OFF

Positive logic remote on/off turns the module on during a logic high voltage on the remote on/off pin, and off during a logic low. To turn the power module on and off, the user must supply a switch to control the voltage between the on/off terminal and the -Vin terminal. The switch can be an open collector or equivalent. A logic low is 0V to 1.2V. A logic high is 3.5V to 12V. The maximum sink current at the on/off terminal (Pin 3) during a logic low is $-100\mu\text{A}$.

Table 7. Remote ON/OFF Control:					
Parameter	Condition	Min	Typ	Max	Unit
Converter On	3.5V ~ 12V or Open Circuit				
Converter Off	0V ~ 1.2V or Short Circuit				
Control Input Current (on)	$V_{ctrl} = 5.0\text{V}$	---	0.5	---	mA
Control Input Current (off)	$V_{ctrl} = 0\text{V}$	---	-0.5	---	mA
Control Common	Referenced to Negative Input				
Standby Input Current	Nominal Vin	---	2.5	---	mA

The positive logic remote ON/OFF control circuit is included. Turns the module ON during logic High on the ON/Off pin and turns OFF during logic Low. The ON/OFF input signal ($V_{on/off}$) that referenced to GND. If not using the remote on/off feature, please open circuit between on/off pin and -Vin pin to turn the module on.

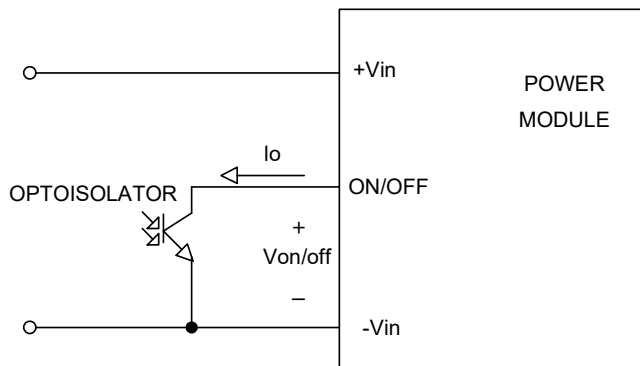

Isolated-Closure Remote ON/OFF

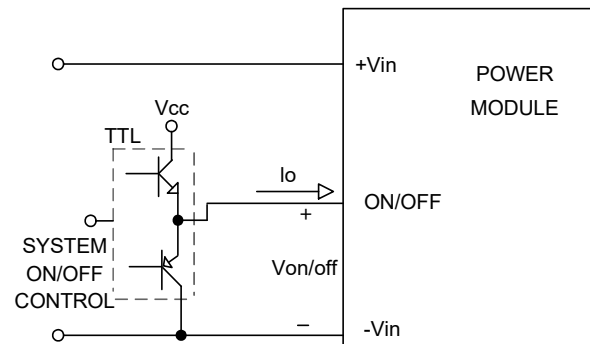

Level Control Using TTL Output

Application Notes

External Output Trimming

Output can be externally trimmed by using the method shown below.

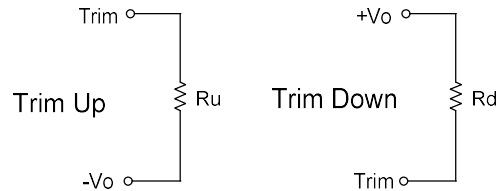

ERM02AXX Trim Table 8

Trim down	1	2	3	4	5	6	7	8	9	10	%
Vout=	Vox0.99	Vox0.98	Vox0.97	Vox0.96	Vox0.95	Vox0.94	Vox0.93	Vox0.92	Vox0.91	Vox0.90	Vdc
Rd=	137.88	61.93	36.61	23.95	16.35	11.29	7.67	4.96	2.85	1.16	KOhm
Trim up	1	2	3	4	5	6	7	8	9	10	%
Vout=	Vox1.01	Vox1.02	Vox1.03	Vox1.04	Vox1.05	Vox1.06	Vox1.07	Vox1.08	Vox1.09	Vox1.10	Vdc
Ru=	108.09	48.39	28.49	18.54	12.56	8.58	5.74	3.61	1.95	0.62	KOhm

ERM00BXX Trim Table 9

Trim down	1	2	3	4	5	6	7	8	9	10	%
Vout=	Vox0.99	Vox0.98	Vox0.97	Vox0.96	Vox0.95	Vox0.94	Vox0.93	Vox0.92	Vox0.91	Vox0.90	Vdc
Rd=	419.81	187.68	110.30	71.61	48.40	32.93	21.87	13.58	7.13	1.98	KOhm
Trim up	1	2	3	4	5	6	7	8	9	10	%
Vout=	Vox1.01	Vox1.02	Vox1.03	Vox1.04	Vox1.05	Vox1.06	Vox1.07	Vox1.08	Vox1.09	Vox1.10	Vdc
Ru=	344.74	154.37	90.92	59.19	40.15	27.46	18.39	11.59	6.31	2.07	KOhm

ERM00CXX Trim Table 10

Trim down	1	2	3	4	5	6	7	8	9	10	%
Vout=	Vox0.99	Vox0.98	Vox0.97	Vox0.96	Vox0.95	Vox0.94	Vox0.93	Vox0.92	Vox0.91	Vox0.90	Vdc
Rd=	602.92	269.91	158.91	103.41	70.10	47.90	32.05	20.15	10.90	3.50	KOhm
Trim up	1	2	3	4	5	6	7	8	9	10	%
Vout=	Vox1.01	Vox1.02	Vox1.03	Vox1.04	Vox1.05	Vox1.06	Vox1.07	Vox1.08	Vox1.09	Vox1.10	Vdc
Ru=	482.88	215.89	126.89	82.40	55.70	37.90	25.18	15.65	8.23	2.30	KOhm

ERM00HXX Trim Table 11

Trim down	1	2	3	4	5	6	7	8	9	10	%
Vout=	Vox0.99	Vox0.98	Vox0.97	Vox0.96	Vox0.95	Vox0.94	Vox0.93	Vox0.92	Vox0.91	Vox0.90	Vdc
Rd=	598.97	267.93	157.59	102.42	69.31	47.25	31.48	19.66	10.46	3.11	Kohm
Trim up	1	2	3	4	5	6	7	8	9	10	%
Vout=	Vox1.01	Vox1.02	Vox1.03	Vox1.04	Vox1.05	Vox1.06	Vox1.07	Vox1.08	Vox1.09	Vox1.10	Vdc
Ru=	486.83	217.87	128.21	83.38	56.49	38.56	25.75	16.14	8.67	2.69	KOhm

APPLICATION NOTES

Packaging Information

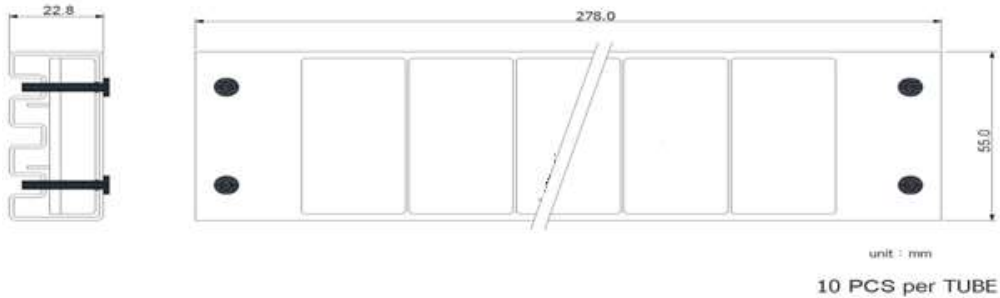

Soldering and Reflow Considerations

Lead free wave solder profile for ERM 10W Series

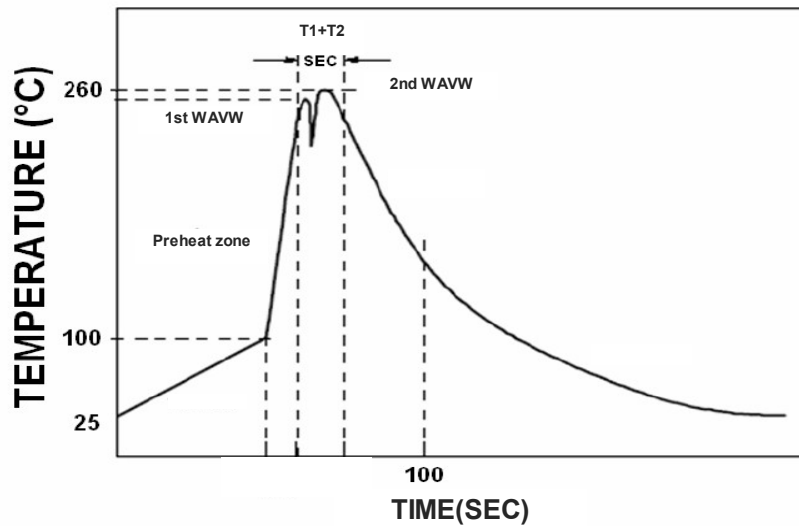

Zone	Reference Parameter
Preheat zone	Rise temp speed: 3°C/sec max.
	Preheat temp : 100~130°C
Actual heating	Peak temp: 250~260°C Peak Time
	Peak time(T1+T2): 4~6 sec

Reference Solder: Sn-Ag-Cu: Sn-Cu: Sn-Ag
 Hand Welding: Soldering iron: Power 60W
 Welding Time: 2~4 sec
 Temp.: 380~400 °C

RECORD OF REVISION AND CHANGES

Issue	Date	Description	Originators
1.0	05.01.2017	First Issue	K. Zou
1.1	12.08.2017	Update the isolation voltage	A. Zhang



For international contact information,
visit advancedenergy.com.

powersales@aei.com (Sales Support)
productsupport.ep@aei.com (Technical Support)
+1 888 412 7832

ABOUT ADVANCED ENERGY

Advanced Energy (AE) has devoted more than three decades to perfecting power for its global customers. AE designs and manufactures highly engineered, precision power conversion, measurement and control solutions for mission-critical applications and processes.

Our products enable customer innovation in complex applications for a wide range of industries including semiconductor equipment, industrial, manufacturing, telecommunications, data center computing, and medical. With deep applications know-how and responsive service and support across the globe, we build collaborative partnerships to meet rapid technological developments, propel growth for our customers, and innovate the future of power.

PRECISION | POWER | PERFORMANCE

Specifications are subject to change without notice. Not responsible for errors or omissions. ©2020 Advanced Energy Industries, Inc. All rights reserved. Advanced Energy®, and AE® are U.S. trademarks of Advanced Energy Industries, Inc.