

AVD75-48S1V2

30 Watts

Sixteenth-brick Converter

Total Power: 30 Watts
Input Voltage: 36 to 75 Vdc
of Outputs: Single

Special Features

- Delivers up to 25A output
- Ultra-high efficiency 87% typ. at half load and 84% at full load
- Wide input range: 36V ~ 75V
- Excellent thermal performance
- No minimum load requirement
- RoHS 6 compliant
- Remote control function
- Remote output sense
- Trim function: 80% ~ 110%
- Input under voltage lockout
- Output over current protection
- Output short protection
- Output over voltage protection
- Over temperature protection
- Industry standard sixteenth-brick
- Standard module with base plate or open frame

Safety

IEC/EN/UL 60950-1 and GB4943
CE Mark
UL/TUV
EN55022
UL94, V-0 flammability rating

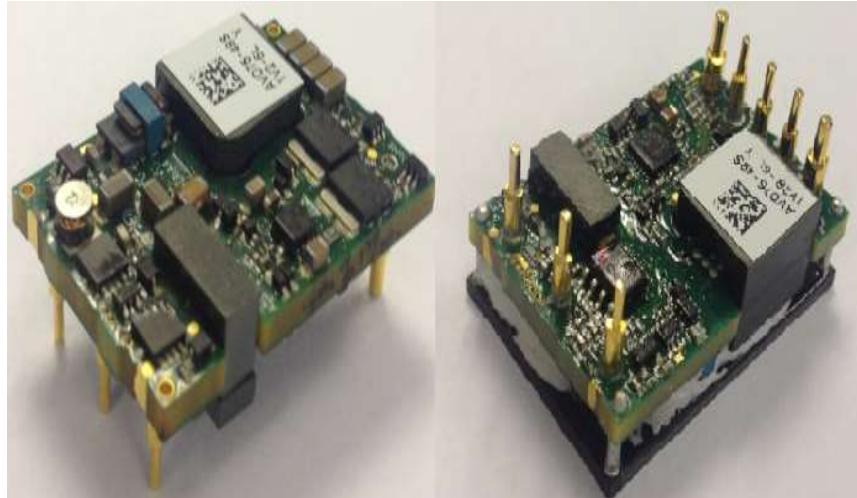

Product Descriptions

The AVD75-48S1V2 is a next-generation industry single output DC/DC converter with standard sixteenth-brick form factor and pin configuration. It delivers up to 25A output current with 1.2V output voltage. Ultra-high efficiency of 87% at half load and 84% at full load, excellent thermal performance makes it an ideal choice for use in computing and telecommunication applications and can operate over an ambient temperature range of -40 °C ~ +85 °C. For most applications, a heat sink is not required.

Applications

Telecom/ Datacom

Model Numbers

Standard	Output Voltage	Structure	Remote ON/OFF logic	RoHS Status
AVD75-48S1V2-6L	1.2Vdc	Open-frame	Negative	R6
AVD75-48S1V2TL	1.2Vdc	Open-frame	Positive	R6
AVD75-48S1V2B-6L	1.2Vdc	Base plate	Negative	R6

Ordering information

AVD75	-	48	S	1V2	P	B	-	6	L
①		②	③	④	⑤	⑥		⑦	⑧

①	Model series	AVD: high efficiency sixteenth brick series
②	Input voltage	48: 36V ~ 75V input range, rated input voltage 48V
③	Output number	S: single output
④	Rated output voltage	1V2: 1.2V output
⑤	Remote ON/OFF logic	Default: negative logic; P: positive logic
⑥	Baseplate	Default: without the baseplate, B:with baseplate
⑦	Pin length	6: 3.8mm pin length T: SMT
⑧	RoHS status	L: RoHS, R6

Options

None

Electrical Specifications

Absolute Maximum Ratings

Stress in excess of those listed in the “Absolute Maximum Ratings” may cause permanent damage to the power supply. These are stress ratings only and functional operation of the unit is not implied at these or any other conditions above those given in the operational sections of this TRN. Exposure to any absolute maximum rated condition for extended periods may adversely affect the power supply’s reliability.

Table 1. Absolute Maximum Ratings:

Parameter	Model	Symbol	Min	Typ	Max	Unit
Input Voltage Operating -Continuous Non-operating -100mS	All	$V_{IN,DC}$	-	-	80	Vdc
	All		-	-	100	Vdc
Maximum Output Power	All	$P_{O,max}$	-	-	30	W
Isolation Voltage ¹ Input to output Input to baseplate Output to baseplate	All		1500	-	-	Vdc
			1000	-	-	
			1500	-	-	
Ambient Operating Temperature	All	T_A	-40	-	+85	°C
Storage Temperature	All	T_{STG}	-55	-	+125	°C
Voltage at remote ON/OFF pin	All		-0.3	-	+5	Vdc
Humidity (non-condensing) Operating Non-operating	All		-	-	95	%
	All		-	-	95	%

Note 1 - Basic insulation, pollution degree 2, 1mA for 60s slew rate of 2000V/10s

Input Specifications

Table 2. Input Specifications:

Parameter	Conditions	Symbol	Min	Typ	Max	Unit
Operating Input Voltage, DC	All	$V_{IN,DC}$	36	48	75	Vdc
Turn-on Voltage Threshold	$I_O = I_{O,max}$	$V_{IN,ON}$	31	-	36	Vdc
Turn-off Voltage Threshold	$I_O = I_{O,max}$	$V_{IN,OFF}$	30	-	35	Vdc
Lockout Voltage Hysteresis	$I_O = I_{O,max}$		1	-	3	V
Maximum Input Current ($I_O = I_{O,max}$)	$V_{IN,DC} = 36V_{DC}$	$I_{IN,max}$	-	-	1.2	A
No-load Input Current			-	0.02	-	A
Standby Input Current	Remote OFF		-	4	7	mA
Recommended Input Fuse	Fast blow external fuse recommended; Figure 21		-	-	5	A
Input current transient rating	Figure 25		-	-	1.5	A ² s
Recommended External Input Capacitance	Low ESR capacitor recommended; Figure 21	C_{IN}	100	-	-	uF
Input Reflected Ripple Current	Through 12uH inductor; Figure25		-	-	40	mA
Operating Efficiency	$T_A = 25\text{ }^{\circ}\text{C}$ $I_O = I_{O,max}$ $I_O = 50\%I_{O,max}$ $I_O = 20\%I_{O,max}$	η	-	84 87 82	-	% % %

Output Specifications

Table 3. Output Specifications:

Parameter	Condition	Symbol	Min	Typ	Max	Unit	
Factory Set Voltage	$V_{IN,DC} = 48V_{DC}$ $I_O = I_{O,max}$	V_O	1.181	1.2	1.218	Vdc	
Total Regulation	Inclusive of sample line, load, temperature & life	V_O	1.142	1.2	1.257	Vdc	
Output Voltage Line Regulation	All	$\%V_O$	-	± 0.25	± 1	%	
Output Voltage Load Regulation	All	$\%V_O$	-	± 0.25	± 1	%	
Output Voltage Temperature Regulation	All	$\%V_O$	-	-	± 0.02	$\%/^{\circ}C$	
Output Voltage Trim Range	All	V_O	0.96	-	1.32	V	
Output Ripple, pk-pk	Measure with a 1uF ceramic capacitor in parallel with a 10uF tantalum capacitor, 0 to 20MHz bandwidth	V_O	-	45	-	mV_{PK-PK}	
Output Current	All	I_O	0	-	25	A	
Output DC current-limit inception ²	All	I_O	27	-	38	A	
V_O Load Capacitance ³	All	C_O	220	-	10000	μF	
V_O Dynamic Response	Peak deviation	25%~50%~25%	-	-	20	mV	
	Settling time	25% load change slew rate = 0.1A/us	-	-	100	μSec	
Turn-on transient	Rise time	$I_O = I_{max}$	T_{rise}	-	5	30	mS
	Turn-on delay time	$I_O = I_{max}$	$T_{turn-on}$	-	-	100	mS
	Output voltage overshoot	$I_O = 0$	$\%V_O$	-	0	-	%

Note 2 - Hiccup: auto-restart when over-current condition is removed.

Note 3 - High frequency and low ESR is recommended.

Output Specifications

Table 3. Output Specifications, con't:

Parameter	Condition	Symbol	Min	Typ	Max	Unit
Switching frequency	All	f_{sw}	-	230	-	KHz
Remote ON/OFF control (positive logic)	Off-state voltage		-0.3	-	1.2	V
	On-state voltage		3.5	-	5	V
Remote ON/OFF control (negative logic)	Off-state voltage		3.5	-	5	V
	On-state voltage		-0.3	-	1.2	V
Output over-voltage protection ⁴	All	V_O	1.44	-	1.9	V
Output over-temperature shutdown ⁵	All	T	-	118	-	°C
Over-temperature hysteresis	All	T	-	10	-	°C
MTBF	300LFM, 40°C Ta Normal Input/ Rated Output@80%load		2.0	-	-	10 ⁶ h

Note 4 - Hiccup: auto-restart when over-voltage condition is removed.

Note 5 - Auto recovery; over-temperature protect(OTP) test point: see Figure 10.

AVD75-48S1V2 Performance Curves

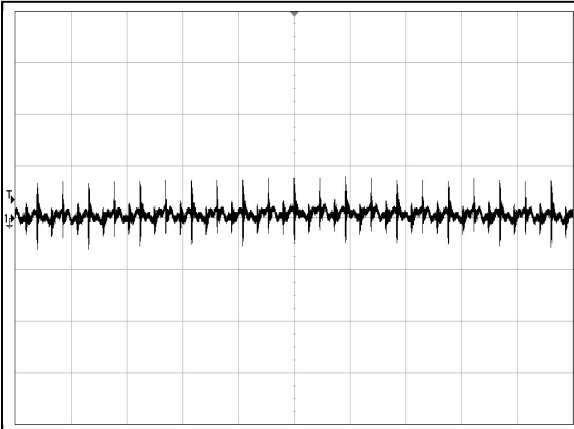

Figure 1: AVD75-48S1V2 Input Reflected Ripple Current Waveform
 Ch 1: Iin (5 μ S/div, 10mA/div)

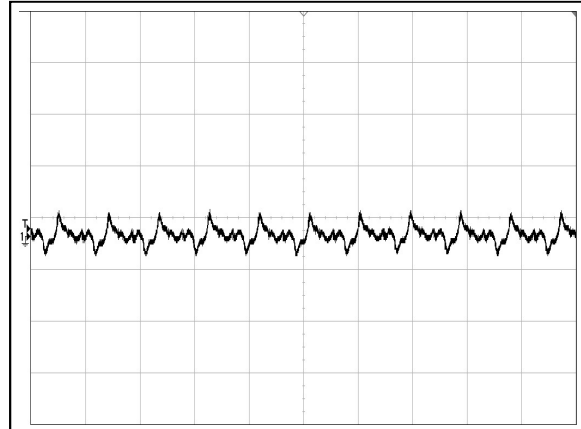

Figure 2: AVD75-48S1V2 Ripple and Noise Measurement
 Ch 1: Vo (5 μ S/div, 50mV/div)

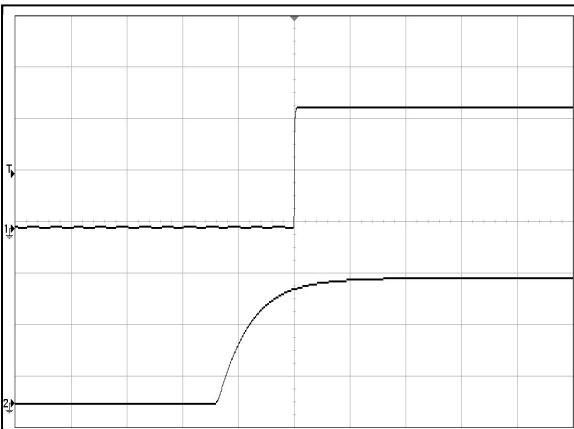

Figure 3: AVD75-48S1V2 Output Voltage Startup Characteristic (50mS/div)
 Ch 1: Vout (500mV/div) Ch 2: Vin (20V/div)

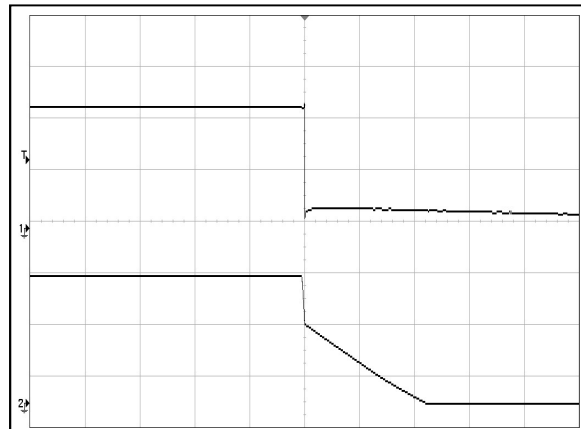

Figure 4: AVD75-48S1V2 Turn Off Characteristic (100mS/div)
 Ch 1: Vout (500mV/div) Ch 2: Vin (20V/div)

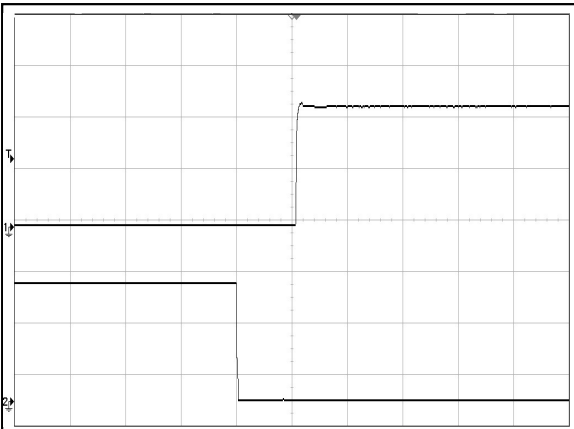

Figure 5: AVD75-48S1V2 Remote ON Waveform (20mS/div)
 (Negative logic)
 Ch 1: Vout (500mV/div) Ch 2: Remote ON (2V/div)

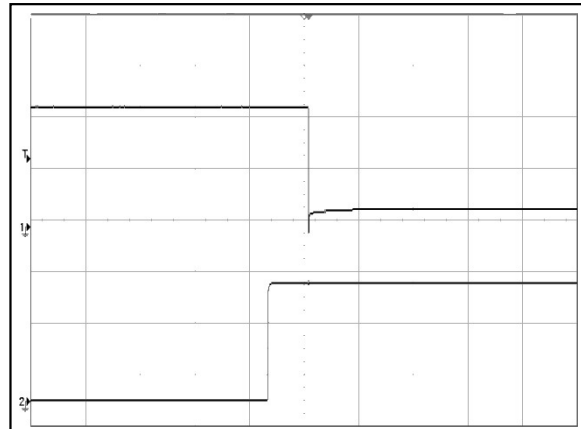

Figure 6: AVD75-48S1V2 Remote OFF Waveform (20mS/div)
 (Negative logic)
 Ch 1: Vout (500mV/div) Ch 2: Remote OFF (2V/div)

AVD75-48S1V2 Performance Curves

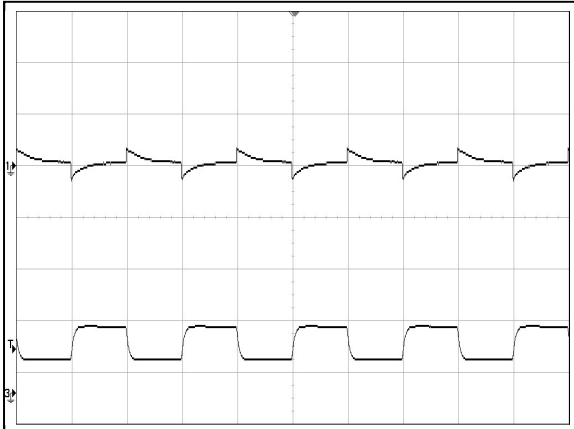

Figure 7: AVD75-48S1V2 Transient Response (2mS/div)
 25%-50%~25% load change, 0.1A/uS slew rate,
 Ch 1: Vout (50mv/div) Ch 2: Iout (10A/div)

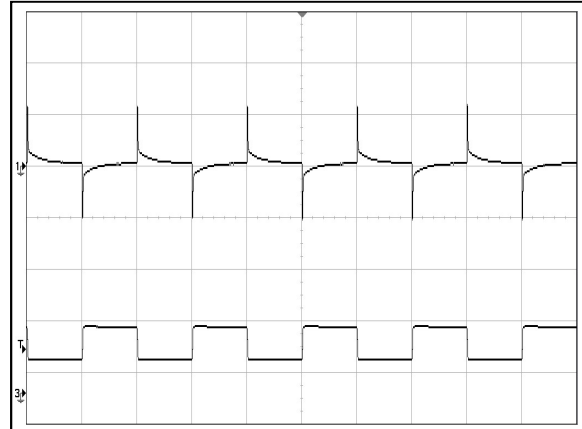

Figure 8: AVD75-48S1V2 Transient Response (1mS/div)
 25%-50%~25% load change, 1A/uS slew rate,
 Ch 1: Vout (50mv/div) Ch 2: Iout (10A/div)

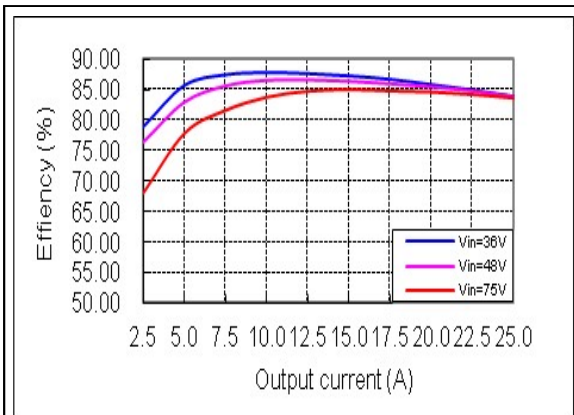
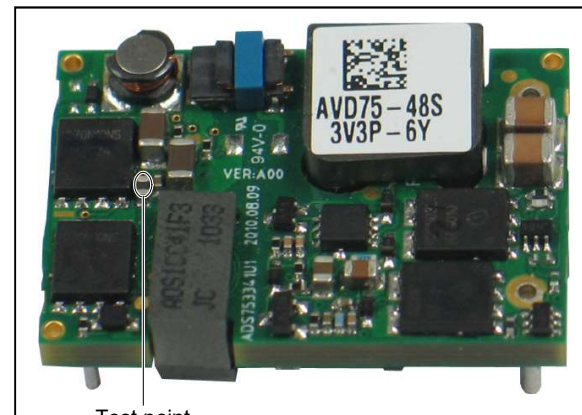

Figure 9: AVD75-48S1V2 Efficiency Curves @ 25 degC

Loading: I_o = 10% increment to 25A Air velocity=300LF



Test point

Figure 10: OTP test point

Mechanical Specifications

Mechanical Outlines – Open Frame Module

AVD75-48S1V2

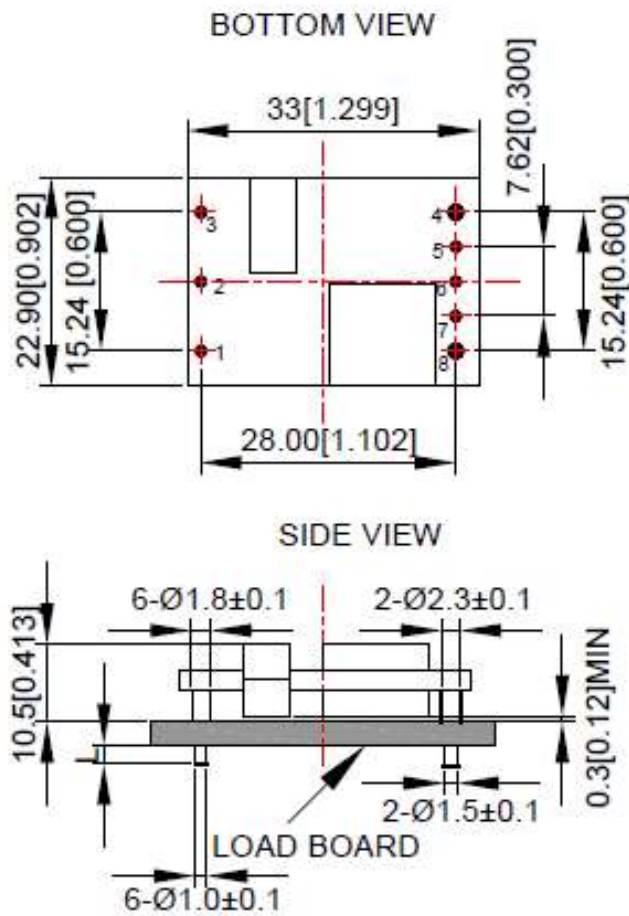

UNIT: mm[inch]

BOTTOM VIEW: pin on upside

TOLERANCE: X.Xmm \pm 0.5mm[X.XX in. \pm 0.02in.]

X.XXmm \pm 0.25mm[X.XXX in. \pm 0.01in.]

Open Frame Module

Figure 11 Mechanical diagram

Pin Length Option

Device code suffix	L
-4	4.8mm ±0.2 mm
-6	3.8mm ±0.2 mm
-8	2.8mm ±0.2 mm
None	5.8mm ±0.2 mm

Pin Designations

Pin No	Name	Function
1	Vin+	Positive input voltage
2	Remote On/Off	Remote control
3	Vin-	Negative input voltage
4	Vo-	Negative output voltage
5	S-	Negative remote sense
6	Trim	Output voltage trim
7	S+	Positive remote sense
8	Vo+	Positive output voltage

Environmental Specifications

EMC Immunity

AVD75-48S1V2 power supply is designed to meet the following EMC immunity specifications:

Table 4. Environmental Specifications:

Document	Description	Criteria
EN55022, Class A Limits	Conducted and Radiated EMI Limits, DC input port	
IEC/EN 61000-4-2, Level 3	Electromagnetic Compatibility (EMC) - Testing and measurement techniques - Immunity to Electrostatic Discharge. Enclosure Port	B
IEC/EN 61000-4-4, Level 3	Electromagnetic Compatibility (EMC) - Testing and measurement techniques, Immunity to Electrical Fast Transient. DC input port.	B
IEC/EN 61000-4-5,	Electromagnetic Compatibility (EMC) - Testing and measurement techniques, Immunity to Surges - 600V common mode and 600V differential mode for DC port	B
IEC/EN 61000-4-6, Level 2	Electromagnetic Compatibility (EMC) - Testing and measurement techniques, Immunity to Continuous Conducted Interference. DC input port	A
EN61000-4-29	Electromagnetic Compatibility (EMC) - Testing and measurement techniques, Immunity to Voltage Dips and Short interruptions and Voltage Variations. DC input port	B

Criterion A: Normal performance during and after test.

Criterion B: For EFT and surges, low-voltage protection or reset is not allowed. Temporary output voltage fluctuation ceases after disturbances ceases, and from which the EUT recovers its normal performance automatically.

For Dips and ESD, output voltage fluctuation or reset is allowed during the test, but recovers to its normal performance automatically after the disturbance ceases.

EMC Test Conditions

See Figure18.

Safety Certifications

The AVD75-48S1V2 power supply is intended for inclusion in other equipment and the installer must ensure that it is in compliance with all the requirements of the end application. This product is only for inclusion by professional installers within other equipment and must not be operated as a stand alone product.

Table 5. Safety Certifications for AVD75-48S1V2 power supply system

Document	File #	Description
UL/CSA 60950		US and Canada Requirements
EN60950		European Requirements
IEC60950		International Requirements
CE		CE Marking

Operating Temperature

The AVD75-48S1V2-6L series power supplies will start and operate within stated specifications at an ambient temperature from -40 °C to 85 °C under all load conditions. The storage temperature is -55 °C to 125 °C.

Thermal Considerations – Open-frame module

The converter is designed to operate in different thermal environments and sufficient cooling must be provided. Proper cooling of the DC/DC converter can be verified by measuring the temperature at the test point as shown in the Figure 12 and Figure 13. The temperature at this point should not exceed the max values in the table 7.

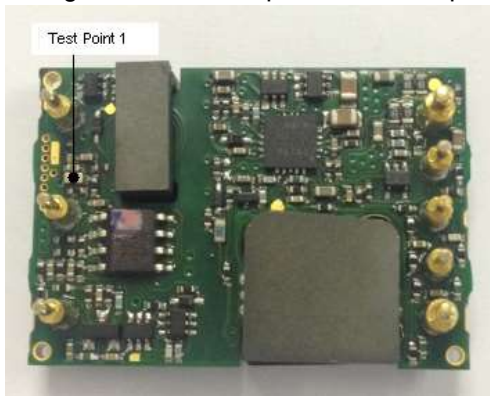

Figure 12 Temperature test point(Bottom)

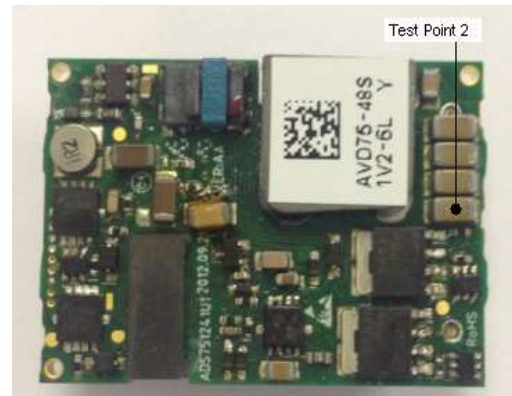

Figure 13 Temperature test point(Top)

Table 7. Temperature limit of the test point

Test Point	Temperature Limit
Test point 1	109 °C
Test point 2	117 °C

For a typical application, figure 14 shows the derating of output current vs. ambient air temperature at different air velocity.

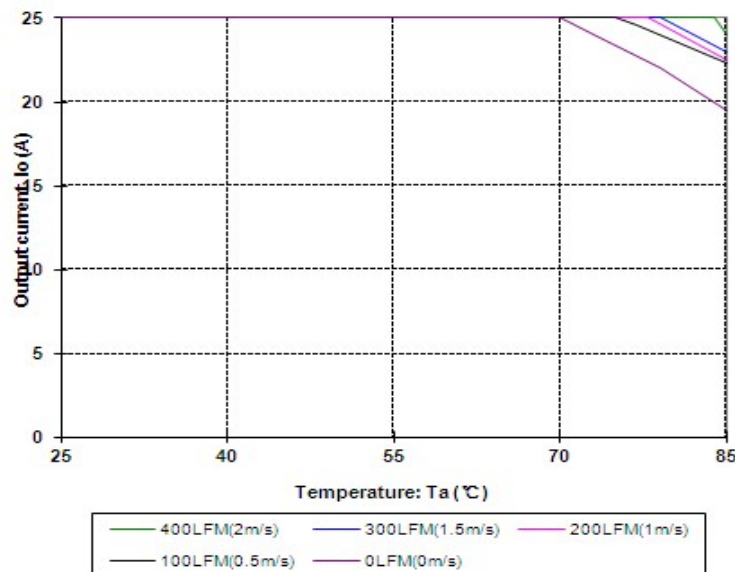

Figure 14 Output power derating, 48Vin, air flowing across the converter from Vin- to Vin+

Operating Temperature

The AVD75-48S1V2B-6L series power supplies will start and operate within stated specifications at an ambient temperature from -40 °C to 85 °C under all load conditions. The storage temperature is -55 °C to 125 °C.

Thermal Considerations – Open-frame module

The converter is designed to operate in different thermal environments and sufficient cooling must be provided. Proper cooling of the DC/DC converter can be verified by measuring the temperature at the test point as shown in the Figure 15 and Figure 16. The temperature at this point should not exceed the max values in the table 7.

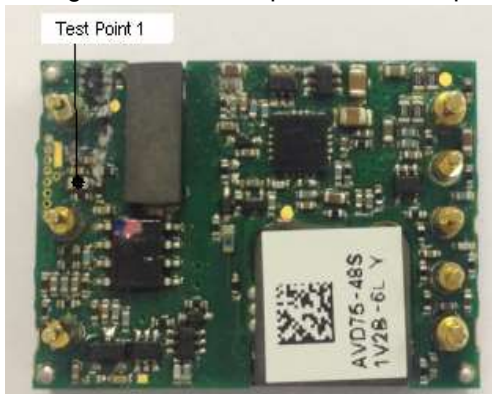

Figure 15 Temperature test point(Bottom)

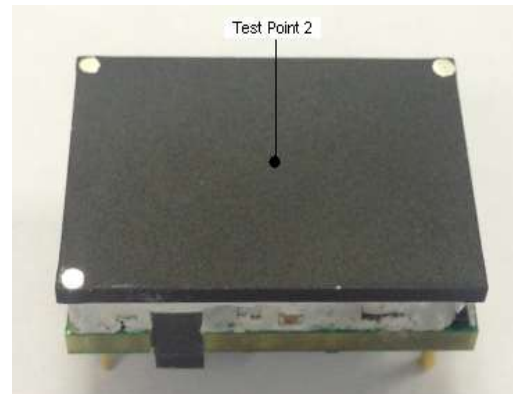

Figure 16 Temperature test point(Top)

Table 7. Temperature limit of the test point

Test Point	Temperature Limit
Test point 1	110 °C
Test point 2	111 °C

For a typical application, figure 17 shows the derating of output current vs. ambient air temperature at different air velocity.

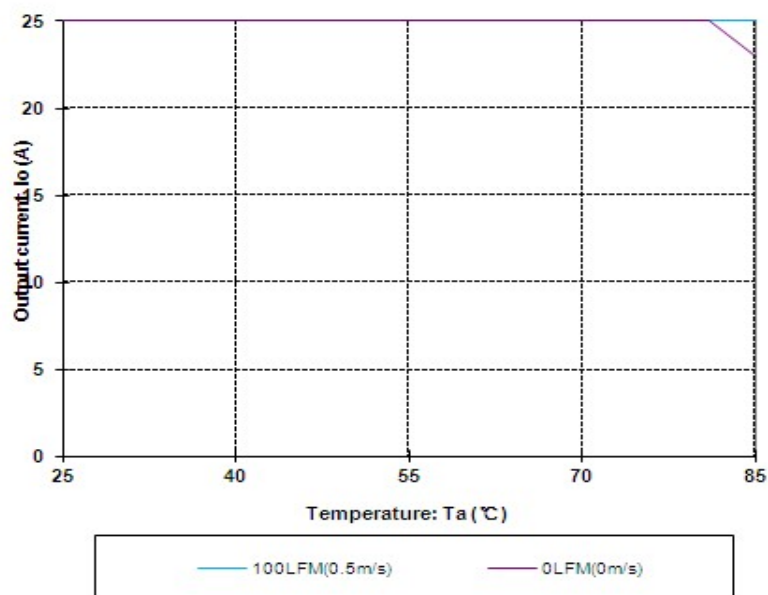

Figure 17 Output power derating, 48Vin, air flowing across the converter from Vin- to Vin+

Qualification Testing

Parameter	Unit (pcs)	Test condition
Halt test	4-5	$T_{a,min} - 10\text{ }^{\circ}\text{C}$ to $T_{a,max} + 10\text{ }^{\circ}\text{C}$, $5\text{ }^{\circ}\text{C}$ step, V_{in} = min to max, 0 ~ 105% load
Vibration	3	Frequency range: 5Hz ~ 20Hz, 20Hz ~ 200Hz, A.S.D: $1.0\text{m}^2/\text{s}^3$, -3db/oct, axes of vibration: X/Y/Z, Time: 30min/axes
Mechanical Shock	3	30g, 6ms, 3axes, 6directions, 3time/direction
Thermal Shock	3	$-40\text{ }^{\circ}\text{C}$ to $100\text{ }^{\circ}\text{C}$, unit temperature 20cycles
Thermal Cycling	3	$-40\text{ }^{\circ}\text{C}$ to $85\text{ }^{\circ}\text{C}$, temperature change rate: $1^{\circ}\text{C}/\text{min}$, cycles: 2cycles
Humidity	3	$40\text{ }^{\circ}\text{C}$, 95%RH, 48h
Solder Ability	15	IPC J-STD-002C-2007

Application Notes

Typical Application

Below is the typical application of the AVD75-48S1V2 power supply.

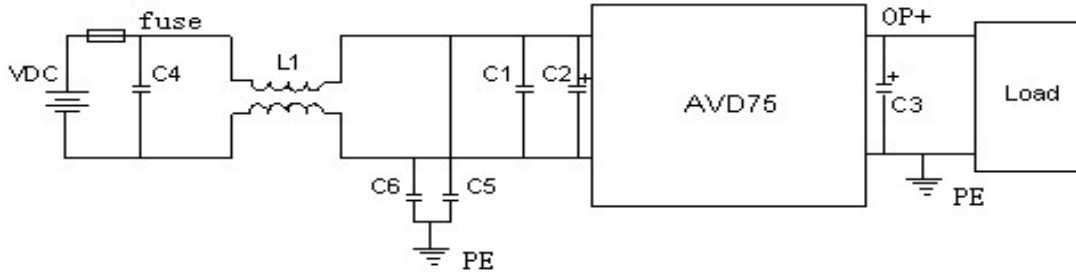

Figure 18 Typical application

Recommended input fuse:Littel fuse 0453005.MR 5A

C4: SMD ceramic-100V-1000nF-X7R-1210

C1: SMDceramic-100V-100nF-± 10%-X7R-1206

C2: 100µF/100V electrolytic capacitor, high frequency and low ESR

C3: 470µF/100V electrolytic capacitor, high frequency and low ESR

C5, C6: SMD ceramic- 22nF/1000V/X7R-1210

L1: 1320uH-± 25%-4A-R5K-21× 21× 12.5mm

Remote ON/OFF

Negative remote ON/OFF logic is available in AVD75-48S1V2. The logic is CMOS and TTL compatible. The voltage between pin Remote ON/OFF and pin Vin- must not exceed the range listed in table “Feature characteristics” to ensure proper operation. The external Remote ON/OFF circuit is highly recommended as shown in figure 19.

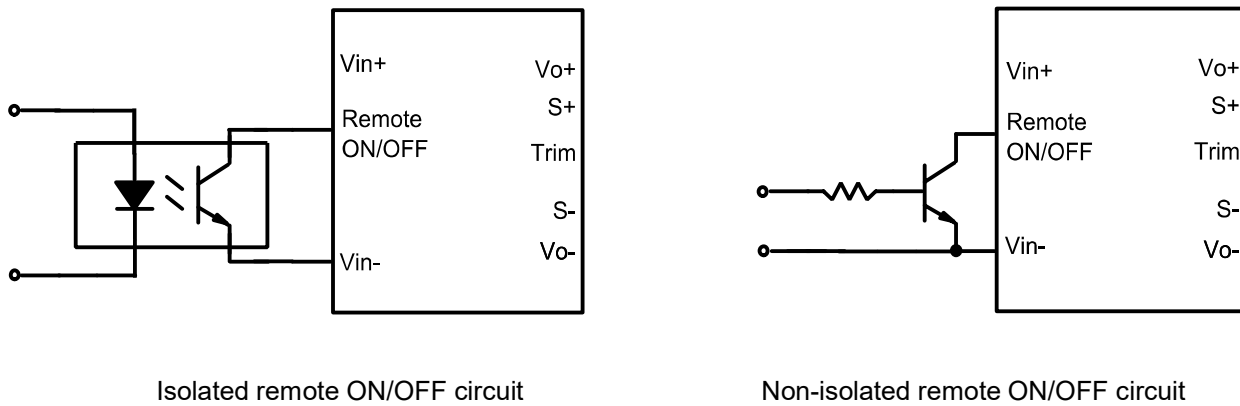

Figure 19 External Remote ON/OFF circuit

Trim Characteristics

Connecting an external resistor between Trim pin and Vo- pin will decrease the output voltage. While connecting it between Trim and Vo+ will increase the output voltage. The following equations determine the external resistance to obtain the trimmed output voltage.

$$R_{adj-down} = \left(\frac{511}{\Delta\%} - 10.22 \right) K\Omega$$

$$R_{adj-up} = \left(\frac{5.11 \times V_{out} \times (100 + \Delta\%)}{V_{ref} \times \Delta\%} - \frac{511}{\Delta\%} - 10.22 \right) K\Omega$$

$R_{adj-down}$: Value of external adjustment resistor which shall be connected between Trim and –Sense for trimming down.

$\Delta\%$: Output voltage change rate against nominal output voltage.

R_{adj-up} : Value of external adjustment resistor which shall be connected between Trim and +Sense for trimming up.

V_{out} : Nominal output voltage.

$$V_{ref} = 0.6 \text{ V}$$

When trimming up, the output current should be decreased accordingly so as not to exceed the maximum output power and the minimum input voltage should be increased as shown in below figure.

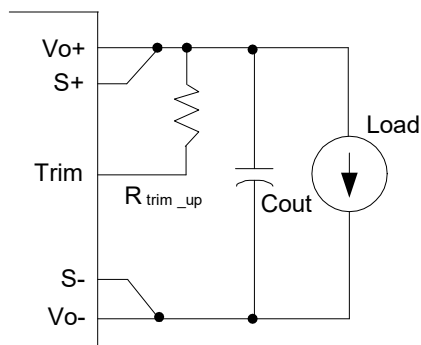

Figure 20 Trim up

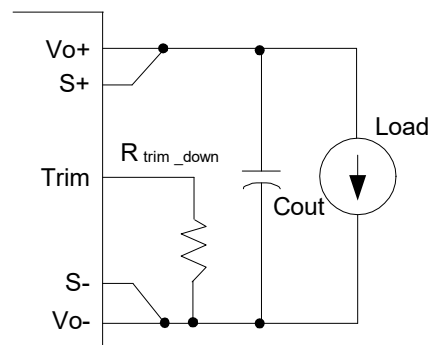

Figure 21 Trim down

Input Ripple & Output Ripple & Noise Test Configuration

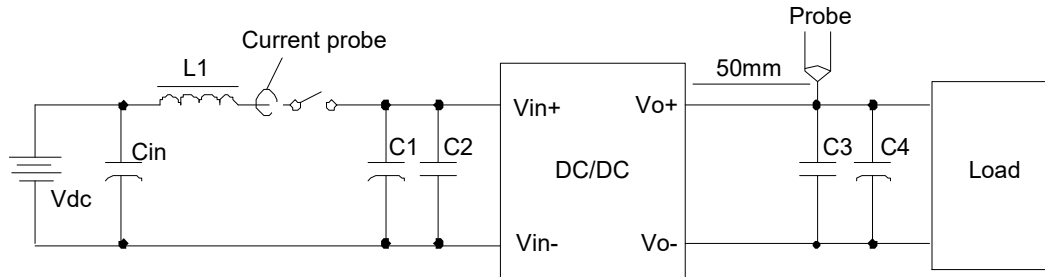

Figure 22 Input ripple & output ripple & noise test configuration

Vdc: DC power supply

L1: 12 μ H

Cin: 220 μ F/100V typical

C1: 100 μ F/100V electrolytic capacitor, high frequency and low ESR

C2: SMD ceramic-100V-100nF- \pm 10%-X7R-1206

C3: SMD ceramic-10V-1 μ F- \pm 10%-X7R-1206

C4: 470 μ F/10V electrolytic capacitor, high frequency and low ESR

Note: Using a coaxial cable with series 50 Ω resistor and 0.68 μ F ceramic capacitor or a ground ring of probe to test output ripple & noise is recommended.

Application Notes

Soldering

The product is intended for standard manual or wave soldering.

	Product Requirement	Product Name
R6	Wave soldering	AVD75-48S1V2-6L AVD75-48S1V2B-6L

When wave soldering is used, the temperature on pins is specified to maximum 260 °C for maximum 7s.

When soldering by hand, the iron temperature should be maintained at 300 °C ~ 380 °C and applied to the converter pins for less than 10s. Longer exposure can cause internal damage to the converter. Cleaning of solder joint can be performed with cleaning solvent IPA or simulative.

The below product is intended for standard reflow soldering.

	Product Requirement	Product Name
R6	Reflow soldering	AVD75-48S1V2-6L AVD75-48S1V2TL

When reflow soldering is used, Please refer to following fig for recommended temperature profile parameters..

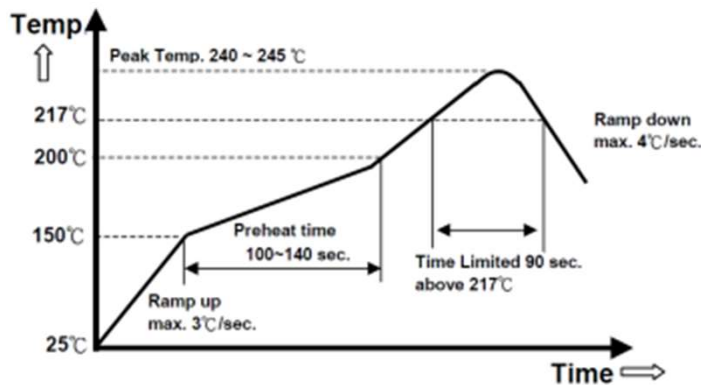

Hazardous Substances Announcement (RoHS of China R6)

Parts	Hazardous Substances					
	Pb	Hg	Cd	Cr ⁶⁺	PBB	PBDE
AVD75 -48S1V2-6L	○	○	○	○	○	○

○: Means the content of the hazardous substances in all the average quality materials of the part is within the limits specified in SJ/T-11363-2006

√: Means the content of the hazardous substances in at least one of the average quality materials of the part is outside the limits specified in SJ/T11363-2006

Artesyn Embedded Technologies has been committed to the design and manufacturing of environment-friendly products. It will reduce and eventually eliminate the hazardous substances in the products through unremitting efforts in research. However, limited by the current technical level, the following parts still contain hazardous substances due to the lack of reliable substitute or mature solution:

1. Solders (including high-temperature solder in parts) contain plumbum.
2. Glass of electric parts contains plumbum.
3. Copper alloy of pins contains plumbum

Record of Revision and Changes

Issue	Date	Description	Originators
1.0	08.29.2014	First Issue	K. Wang
1.1	10.25.2016	Updated the mechanical drawing	K. Wang
1.2	12.13.2019	Updated soldering information	K. Zou

WORLDWIDE OFFICES

Americas

2900 South Diablo Way
 Suite B100
 Tempe, AZ 85282
 USA
 +1 888 412 7832

Europe (UK)

Ground Floor Offices
 Barberrry House, 4 Harbour Buildings
 Waterfront West, Brierley Hill
 West Midlands, DY5 1LN, UK
 +44 (0) 1384 842 211

Asia (HK)

14/F, Lu Plaza
 2 Wing Yip Street
 Kwun Tong, Kowloon
 Hong Kong
 +852 2176 3333



For more information: www.artesyn.com
 For support: productsupport.ep@artesyn.com