

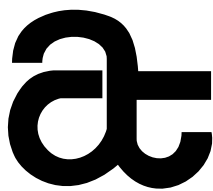

AMERICAN
TECHNICAL
CERAMICS

GENERAL PURPOSE CAPACITORS



THE
ENGINEERS'
CHOICE®

Low Cost Multilayer Ceramic Capacitors
For Surface Mount Applications

Manufactured for ATC

ISO 9001
REGISTERED
COMPANY



ATC 001-847, Rev. Y; 4/18

ATC GENERAL PURPOSE CAPACITORS: NPO (COG) DIELECTRIC

Electrical Characteristics

Capacitance Range:

0.5 pF to 0.12 μ F

Temperature Coefficient of Capacitance:

0 \pm 30ppm/ $^{\circ}$ C

Operating Temperature Range:

-55 $^{\circ}$ C to +125 $^{\circ}$ C

Dissipation Factor:

0.1% (max.) for C \geq 30 pF @ 25 $^{\circ}$ C @1 MHz

0.25% (max.) for C < 30 pF @ 25 $^{\circ}$ C @1 MHz

Insulation Resistance:

@ + 25 $^{\circ}$ C and rated Vdc:100,000 megohms (min.) or

1000 ohm-farads (min.),whichever is less

Aging:

None

Dimension Drawing

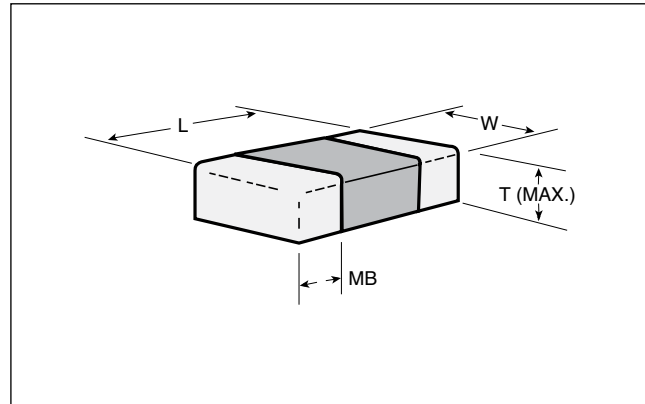

Dielectric Withstanding Voltage:

250% WVDC for WVDC < 200V

150% WVDC for 200V < WVDC \leq 500V

120% WVDC for WVDC > 500V Applied for 5 \pm 1 sec.

Note: Unless otherwise specified all test data is at + 25 $^{\circ}$ C.

NPO Temperature Coefficient of Capacitance

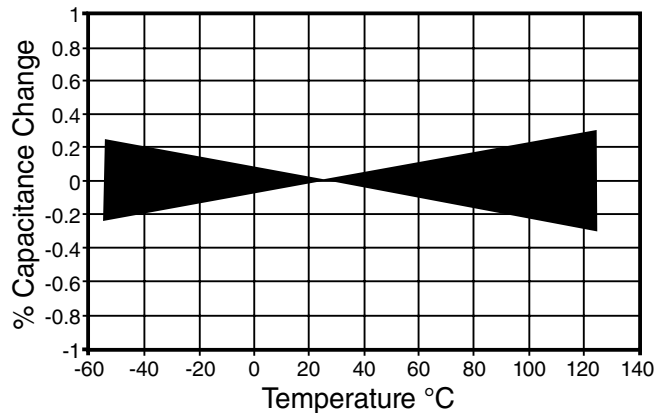

NPO Impedance vs. Frequency

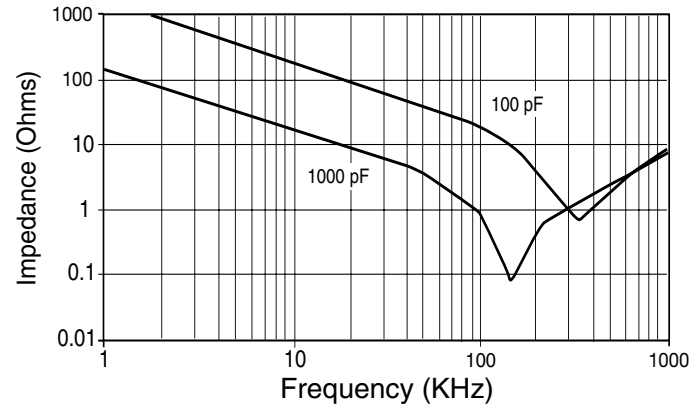

Standard EIA Capacitance Values Reference Chart

Note: Upper capacitance value limit for NPO is .12 μ F

Cap. Code	Cap. pF	Cap. Code	Cap. pF	Cap. Code	Cap. pF	Cap. Code	Cap. pF	Cap. Code	Cap. pF	Cap. Code	Cap. μ F	Cap. Code	Cap. μ F	Cap. Code	Cap. μ F
0R5	0.5	8R2	8.2	820	82	821	820	822	8200	563	.056	474	.47	335	3.3
1R0	1.0	100	10	101	100	102	1000	Cap. Code Cap. μ F		683	.068	564	.56	395	3.9
1R2	1.2	120	12	121	120	122	1200	103	.010	823	.082	684	.68	475	4.7
1R5	1.5	150	15	151	150	152	1500	123	.012	104	.10	824	.82	565	5.6
1R8	1.8	180	18	181	180	182	1800	153	.015	124	.12	105	1.0	685	6.8
2R2	2.2	220	22	221	220	222	2200	183	.018	154	.15	125	1.2	825	8.2
2R7	2.7	270	27	271	270	272	2700	223	.022	184	.18	155	1.5	106	10.0
3R3	3.3	330	33	331	330	332	3300	273	.027	224	.22	185	1.8	126	12.0
3R9	3.9	390	39	391	390	392	3900	333	.033	274	.27	225	2.2	156	15.0
4R7	4.7	470	47	471	470	472	4700	393	.039	334	.33	275	2.7		
5R6	5.6	560	56	561	560	562	5600	473	.047	394	.39				
6R8	6.8	680	68	681	680	682	6800								

A M E R I C A N T E C H N I C A L C E R A M I C S

ATC North America
sales@atceramics.com

ATC Europe
sales@atceramics.com

ATC Asia
sales@atceramics-asia.com

www.atceramics.com

ATC GENERAL PURPOSE CAPACITORS: NPO (COG) DIELECTRIC

Selection Guide

Case Size	0402	0504	0603	0805	1206	1210	1812	2225
Length (L)	.040 (1.02)	.050 (1.27)	.063 (1.60)	.079 (2.00)	.125 (3.18)	.125 (3.18)	.180 (4.57)	.220 (5.59)
Width (W)	.020 (0.51)	.040 (1.02)	.031 (0.80)	.049 (1.25)	.063 (1.60)	.100 (2.54)	.125 (3.18)	.250 (6.35)
Tol. L & W	±.004 (0.10)	±.006 (.152)	±.005 (0.12)	±.008 (0.2)	±.008 (0.2)	±.008 (0.2)	±.012 (.305)	±.015 (0.38)
T Max.	.024 (0.61)	.044 (1.12)	.035 (0.89)	.054 (1.37)	.064 (1.63)	.070 (1.78)	.100 (2.54)	.150 (3.81)
Term. (MB) Min. Max.	.004 (.10) .014 (.36)	.005 (.12) .015 (.38)	.004 (.10) .015 (.38)	.010 (.25) .030 (.76)	.010 (.25) .030 (.76)	.010 (.25) .030 (.76)	.010 (.25) .030 (.76)	.010 (.25) .030 (.76)
Min. Cap.	0R5	0R5	0R5	0R5	0R5	3R0	100	270
Max. Cap. (code) & WVDC								
10V								
16V	331	182	152	103	223	273	393	124
25V	331	122	102	103	223	223	393	124
50V	331	102	102	103	104	223	333	124
100V	181	561	102	392	562	183	273	683
200V	101	391	561	182	392	103	183	563
500V				821	182	472	103	273
1000V				471	102	222	472	153
200								392
5000V								

Dimensions in inches (mm)
Higher voltages available upon request.

Part Number Code

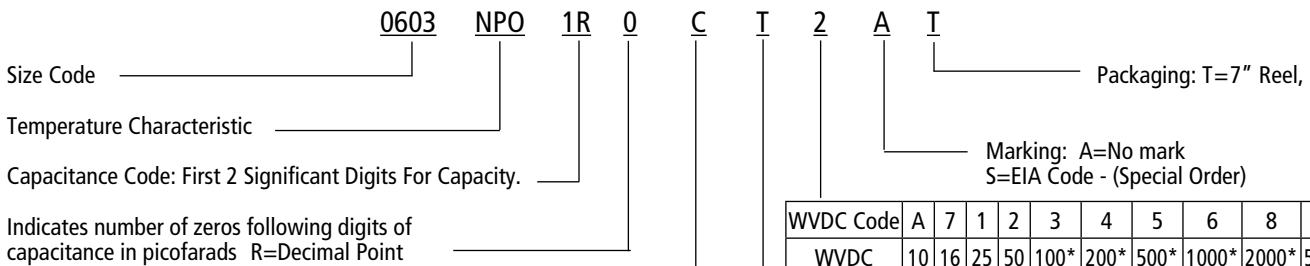

WVDC Code	A	7	1	2	3	4	5	6	8	9
WVDC	10	16	25	50	100*	200*	500*	1000*	2000*	5000*

*Special Order - Consult Factory

CAPACITANCE TOLERANCE					
Code	B*	C	F	G	J
Tol.	±0.1 pF	±0.25 pF	±1%	±2%	±5%
	pF (Values < 10 pF)		% (Values ≥ 10 pF)		

*Tighter tolerances available.



Termination Code

T = Tin plated over Nickel Barrier (Standard), RoHS Compliant
 C = Palladium Silver, (non-magnetic), RoHS Compliant
 Solder and Conductive Epoxy Attachment**
 W = Tin/Lead, Solder Plated over Nickel Barrier**

**Consult ATC for availability

A M E R I C A N T E C H N I C A L C E R A M I C S

ATC North America
sales@atceramics.com

ATC Europe
sales@atceramics.com

ATC Asia
sales@atceramics-asia.com

www.atceramics.com

ATC GENERAL PURPOSE CAPACITORS: X7R DIELECTRIC

Electrical Characteristics

Capacitance Range:

120 pF to 10 μ F

Temperature Coefficient of Capacitance:

$\pm 15\%$ with 0 Vdc applied

Operating Temperature Range:

-55°C to +125°C

Dissipation Factor:

2.5% (max.) @ + 25°C, @1 MHz

≤ 1000 pF; @1 KHz >1000 pF

See Page 9 for DF Exceptions for X7R

Insulation Resistance:

@ + 25°C and rated Vdc:10,000 megohms (min.) or

500 ohm-farads (min.), whichever is less

Aging:

3% (max.) per decade hr.

Dimension Drawing

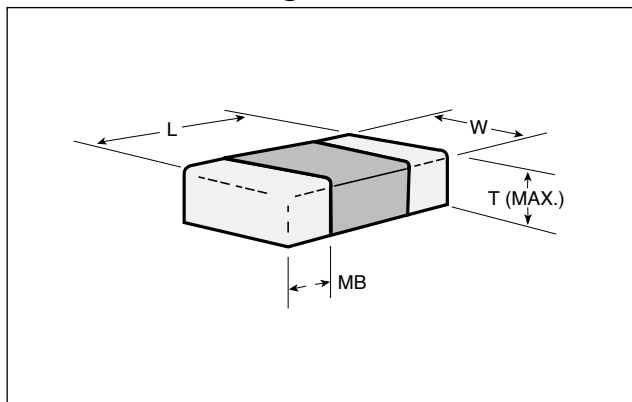

Dielectric Withstanding Voltage:

250% WVDC for WVDC < 200V

150% WVDC for 200V < WVDC \leq 500V

120% WVDC for WVDC > 500V

Applied for 5 \pm 1 sec.

Note: Unless otherwise specified all test data is at + 25°C.

X7R Temperature Coefficient of Capacitance

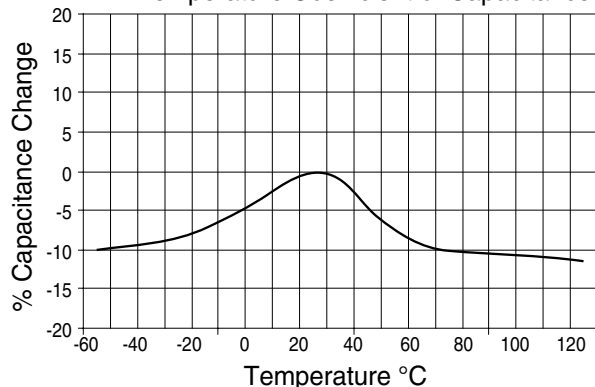

X7R Impedance vs. Frequency

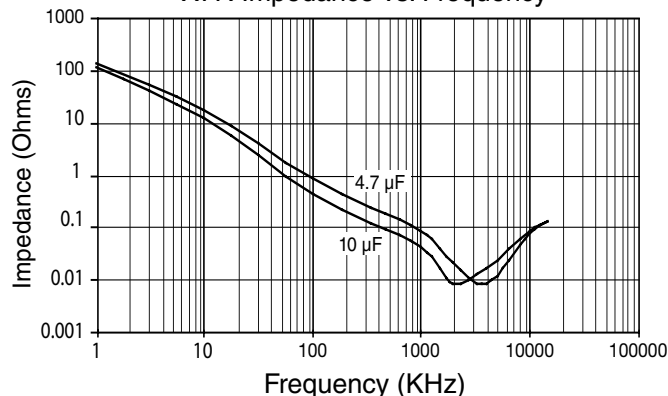

Standard EIA Capacitance Values Reference Chart

Note: Upper capacitance value limit for X7R is 10.0 μ F

Cap. Code	Cap. pF	Cap. Code	Cap. pF	Cap. Code	Cap. pF	Cap. Code	Cap. pF	Cap. Code	Cap. pF	Cap. Code	Cap. μ F	Cap. Code	Cap. μ F	Cap. Code	Cap. μ F
0R5	0.5	8R2	8.2	820	82	821	820	822	8200	563	.056	474	.47	335	3.3
1R0	1.0	100	10	101	100	102	1000	Cap. Code Cap. μ F		683	.068	564	.56	395	3.9
1R2	1.2	120	12	121	120	122	1200	823	.082	684	.68	475	4.7		
1R5	1.5	150	15	151	150	152	1500	103	.010	104	.10	824	.82	565	5.6
1R8	1.8	180	18	181	180	182	1800	123	.012	124	.12	105	1.0	685	6.8
2R2	2.2	220	22	221	220	222	2200	153	.015	154	.15	125	1.2	825	8.2
2R7	2.7	270	27	271	270	272	2700	183	.018	184	.18	155	1.5	106	10.0
3R3	3.3	330	33	331	330	332	3300	223	.022	224	.22	185	1.8	126	12.0
3R9	3.9	390	39	391	390	392	3900	273	.027	274	.27	225	2.2	156	15.0
4R7	4.7	470	47	471	470	472	4700	333	.033	334	.33	275	2.7		
5R6	5.6	560	56	561	560	562	5600	393	.039	394	.39				
6R8	6.8	680	68	681	680	682	6800	473	.047						

A M E R I C A N T E C H N I C A L C E R A M I C S

ATC North America
sales@atceramics.com

ATC Europe
sales@atceramics.com

ATC Asia
sales@atceramics-asia.com

ATC GENERAL PURPOSE CAPACITORS: X7R DIELECTRIC

Selection Guide

Case Size	0402	0504	0603	0805	1206	1210	1812	2225
Length (L)	.040 (1.02)	.050 (1.27)	.063 (1.60)	.079 (2.00)	.125 (3.18)	.125 (3.18)	.180 (4.57)	.220 (5.59)
Width (W)	.020 (0.51)	.040 (1.02)	.031 (0.80)	.049 (1.25)	.063 (1.60)	.100 (2.54)	.125 (3.18)	.250 (6.35)
Tol. L & W	±.004 (0.10)	±.006 (.152)	±.005 (0.12)	±.008 (0.2)	±.008 (0.2)	±.008 (0.2)	±.012 (.305)	±.015 (0.38)
T Max.	.024 (0.61)	.044 (1.12)	.035 (0.89)	.059 (1.50)	.071 (1.80)	.110 (2.79)	.118 (3.00)	.150 (3.81)
Term. (MB) Min. Max.	.004 (.10) .014 (.36)	.005 (.12) .015 (.38)	.004 (.10) .015 (.38)	.010 (.25) .030 (.76)	.010 (.25) .030 (.76)	.010 (.25) .030 (.76)	.010 (.25) .030 (.76)	.010 (.25) .030 (.76)
Min. Cap.	121	121	121	121	121	121	151	471
Max. Cap. (code) & WVDC								
10V			225	105	106			
16V	104	393	105	105	685	106	106	106
25V	273	333	154	105	475	106	106	106
50V	103	273	104	334	334	105	225	225
100V	472	153	104	104	154	105	225	225
200V	222	103	103	333	104	184	474	105
500V				123	223	563	104	334
1000V				272	682	153	273	104
2000V					102	222	472	153
5000V								

Dimensions in inches (mm)

Higher voltages available upon request.

Part Number Code

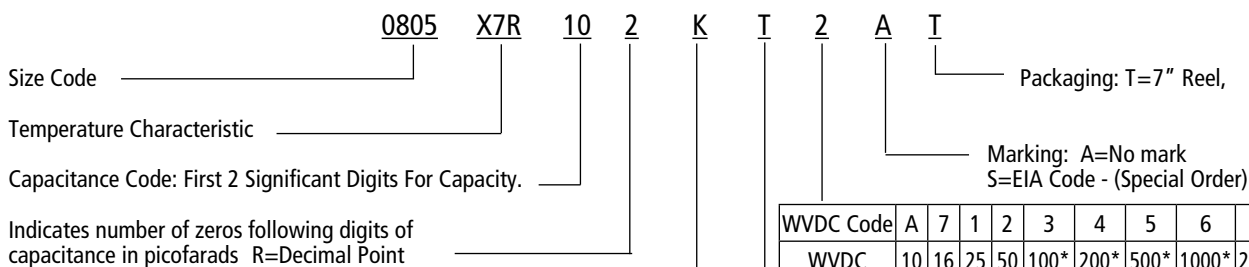

CAPACITANCE TOLERANCE		
Code	J	K
Tol.	±5%	±10%

WVDC Code	A	7	1	2	3	4	5	6	8	9
WVDC	10	16	25	50	100*	200*	500*	1000*	2000*	5000*

*Special Order - Consult Factory



Termination Code

T = Tin plated over Nickel Barrier (Standard), RoHS Compliant
 C = Palladium Silver, (non-magnetic) solderable, RoHS Compliant**
 W = Tin/Lead, Solder Plated over Nickel Barrier**

**Consult ATC for availability

A M E R I C A N T E C H N I C A L C E R A M I C S

ATC North America
sales@atceramics.com

ATC Europe
saleseur@atceramics.com

ATC Asia
sales@atceramics-asia.com

www.atceramics.com

ATC GENERAL PURPOSE CAPACITORS: X5R DIELECTRIC

Electrical Characteristics

Capacitance Range:

0.1 μF to 33 μF

Temperature Coefficient of Capacitance:

$\pm 15\%$ with 0 Vdc applied

Operating Temperature Range:

-55°C to +85°C

Dissipation Factor:

5% (max.) @ + 25°C, @1 KHz @1.0 +/- 0.2 VRMS

See Page 9 for DF Exceptions for X5R

Insulation Resistance:

@ + 25°C and rated Vdc: 10,000 megohms (min.) or 500 ohm-farads (min.), whichever is less

Aging:

3% (max.) per decade hr.

Dimension Drawing

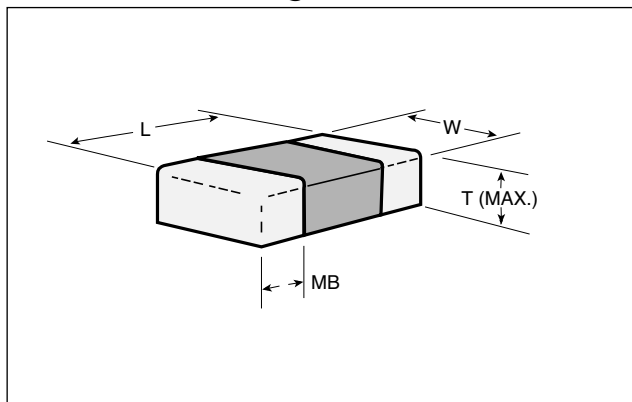

Dielectric Withstanding Voltage:

250% WVDC for WVDC < 200V

150% WVDC for 200V < WVDC \leq 500V

120% WVDC for WVDC > 500V

Applied for 5 \pm 1 sec.

Note: Unless otherwise specified all test data is at + 25°C.

X5R Temperature Coefficient of Capacitance

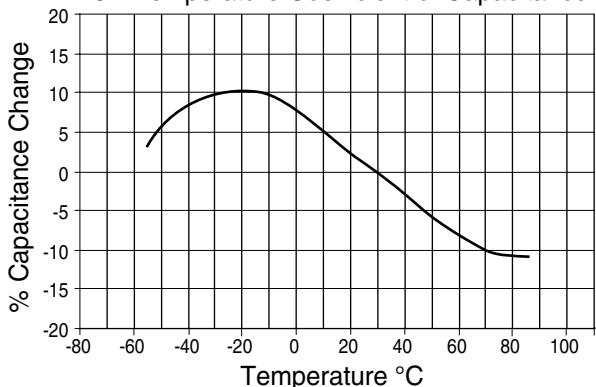

X5R Impedance vs. Frequency

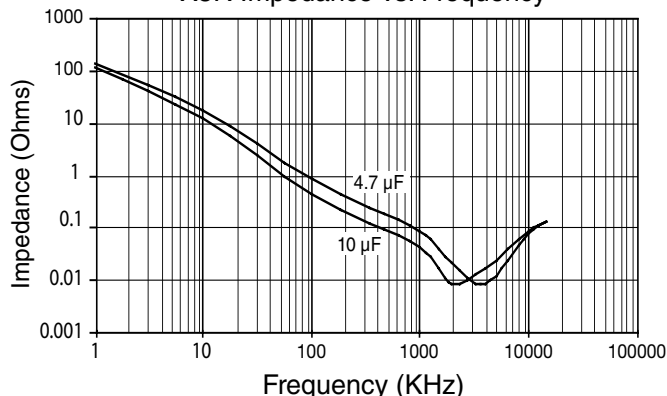

Standard EIA Capacitance Values Reference Chart

Cap. Code	Cap. pF	Cap. Code	Cap. pF	Cap. Code	Cap. pF	Cap. Code	Cap. pF	Cap. Code	Cap. pF	Cap. Code	Cap. μF	Cap. Code	Cap. μF	Cap. Code	Cap. μF
0R5	0.5	8R2	8.2	820	82	821	820	822	8200	563	.056	564	.56	565	5.6
1R0	1.0	100	10	101	100	102	1000	Cap. Code	Cap. μF	683	.068	684	.68	685	6.8
1R2	1.2	120	12	121	120	122	1200			823	.082	824	.82	825	8.2
1R5	1.5	150	15	151	150	152	1500	103	.010	104	.10	105	1.0	106	10.0
1R8	1.8	180	18	181	180	182	1800	123	.012	124	.12	125	1.2	126	12.0
2R2	2.2	220	22	221	220	222	2200	153	.015	154	.15	155	1.5	156	15.0
2R7	2.7	270	27	271	270	272	2700	183	.018	184	.18	185	1.8	186	18.0
3R3	3.3	330	33	331	330	332	3300	223	.022	224	.22	225	2.2	226	22.0
3R9	3.9	390	39	391	390	392	3900	273	.027	274	.27	275	2.7	276	27.0
4R7	4.7	470	47	471	470	472	4700	333	.033	334	.33	335	3.3	336	33.0
5R6	5.6	560	56	561	560	562	5600	393	.039	394	.39	395	3.9		
6R8	6.8	680	68	681	680	682	6800	473	.047	474	.47	475	4.7		

A M E R I C A N T E C H N I C A L C E R A M I C S

ATC North America
sales@atceramics.com

ATC Europe
sales@atceramics.com

ATC Asia
sales@atceramics-asia.com

ATC GENERAL PURPOSE CAPACITORS: X5R DIELECTRIC

Selection Guide

Case Size	0402	0603	0805	1206	1210	1812
Length (L)	.040 (1.02)	.063 (1.60)	.079 (2.00)	.125 (3.18)	.125 (3.18)	.180 (4.57)
Width (W)	.020 (0.51)	.031 (0.80)	.049 (1.25)	.063 (1.60)	.100 (2.54)	.125 (3.18)
Tol. L & W	±.004 (0.10)	±.005 (0.12)	±.008 (0.2)	±.008 (0.2)	±.008 (0.2)	±.012 (.305)
T Max.	.024 (0.61)	.035 (0.89)	.059 (1.50)	.072 (1.83)	.110 (2.79)	.118 (3.00)
Term. (MB) Min. Max.	.004 (.10) .014 (.36)	.004 (.10) .015 (.38)	.010 (.25) .030 (.76)	.010 (.25) .030 (.76)	.010 (.25) .030 (.76)	.010 (.25) .030 (.76)
Min. Cap.	104	474	224	105	335	106
Max. Cap. (code) & WVDC						
10V	105	225	106	106	226	336
16V	104	105	335	106	106	336
25V		564	225	685	106	106
50V			224			

Dimensions shown in inches (mm)
Higher voltages available upon request.

Part Number Code

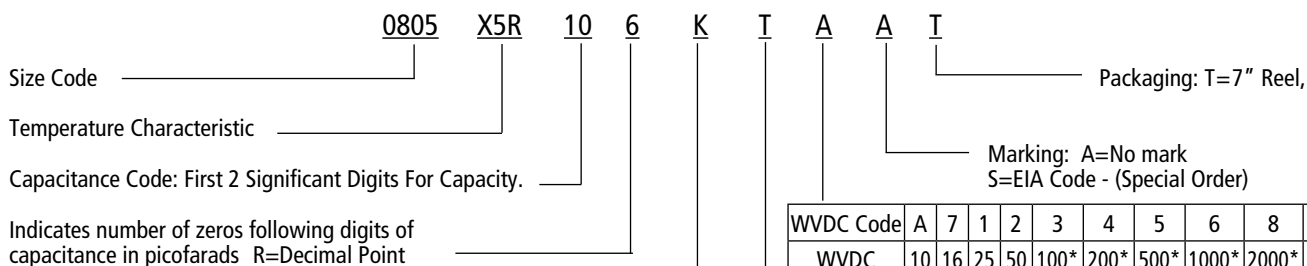

CAPACITANCE TOLERANCE		
Code	K	M
Tol.	±10%	±20%

WVDC Code	A	7	1	2	3	4	5	6	8	9
WVDC	10	16	25	50	100*	200*	500*	1000*	2000*	5000*

*Special Order - Consult Factory



Termination Code

T = Tin plated over Nickel Barrier (Standard),
RoHS Compliant
W = Tin/Lead, Solder Plated over Nickel Barrier**
**Consult ATC for availability

A M E R I C A N T E C H N I C A L C E R A M I C S

ATC North America
sales@atceramics.com

ATC Europe
saleseur@atceramics.com

ATC Asia
sales@atceramics-asia.com

ATC GENERAL PURPOSE CAPACITORS: Z5U/Y5V DIELECTRIC

Electrical Characteristics

Capacitance Range:

0.1 μF to 22 μF

Temperature Coefficient of Capacitance:

Z5U: + 22%, -56%

Y5V: + 22%, -82%

Operating Temperature Range:

Z5U: +10°C to +85°C

Y5V: -30°C to +85°C

Dissipation Factor:

3.5% (max.) @ + 25°C, @1 KHz

See Page 9 for DF Exceptions for Y5V

Insulation Resistance:

@ + 25°C and rated Vdc: 1000 megohms (min.) or 100 ohm-farads (min.) whichever is less

Aging:

3% (max.) per decade hr.

Dimension Drawing

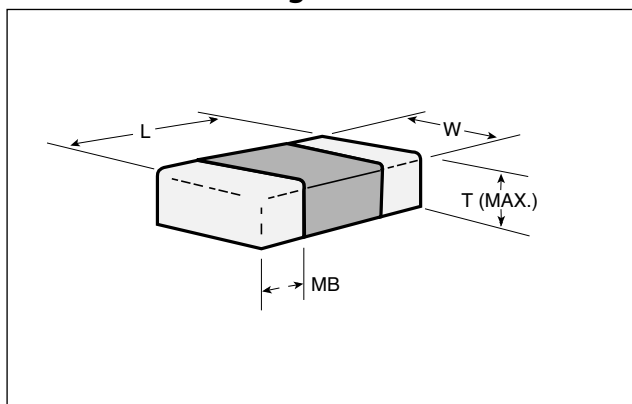

Dielectric Withstanding Voltage:

50% of rated voltage for 5 ± 1 seconds, 50 milliamps (max)

Note: Unless otherwise specified all test data is at + 25°C.

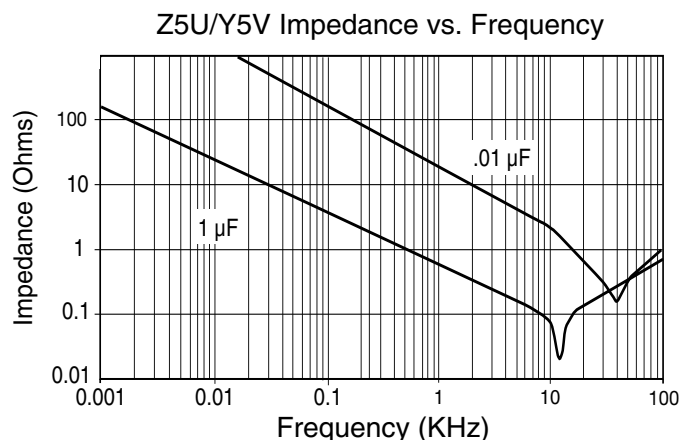
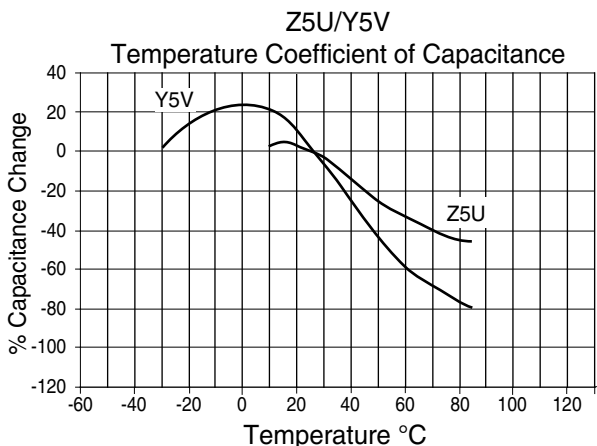

Standard EIA Capacitance Values Reference Chart

Cap. Code	Cap. pF	Cap. Code	Cap. pF	Cap. Code	Cap. pF	Cap. Code	Cap. pF	Cap. Code	Cap. pF	Cap. Code	Cap. μF	Cap. Code	Cap. μF	Cap. Code	Cap. μF
0R5	0.5	8R2	8.2	820	82	821	820	822	8200	563	.056	474	.47	395	3.9
1R0	1.0	100	10	101	100	102	1000	Cap. Code	Cap. μF	683	.068	564	.56	475	4.7
1R2	1.2	120	12	121	120	122	1200			823	.082	684	.68	565	5.6
1R5	1.5	150	15	151	150	152	1500	103	.010	104	.10	824	.82	685	6.8
1R8	1.8	180	18	181	180	182	1800	123	.012	124	.12	105	1.0	825	8.2
2R2	2.2	220	22	221	220	222	2200	153	.015	154	.15	125	1.2	106	10.0
2R7	2.7	270	27	271	270	272	2700	183	.018	184	.18	155	1.5	126	12.0
3R3	3.3	330	33	331	330	332	3300	223	.022	224	.22	185	1.8	156	15.0
3R9	3.9	390	39	391	390	392	3900	273	.027	274	.27	225	2.2	186	18.0
4R7	4.7	470	47	471	470	472	4700	333	.033	334	.33	275	2.7	226	22.0
5R6	5.6	560	56	561	560	562	5600	393	.039	394	.39	335	3.3		
6R8	6.8	680	68	681	680	682	6800	473	.047						

A M E R I C A N T E C H N I C A L C E R A M I C S

ATC North America
sales@atceramics.com

ATC Europe
sales@atceramics.com

ATC Asia
sales@atceramics-asia.com

ATC GENERAL PURPOSE CAPACITORS: Z5U/Y5V DIELECTRIC

Selection Guide

Case Size	0603	0805	1206	1210	1812	2225
Length (L)	.063 (1.60)	.079 (2.00)	.125 (3.18)	.125 (3.18)	.180 (4.57)	.220 (5.59)
Width (W)	.031 (0.80)	.049 (1.25)	.063 (1.60)	.100 (2.54)	.125 (3.18)	.250 (6.35)
Tol. L & W	±.005 (0.12)	±.008 (0.2)	±.008 (0.2)	±.008 (0.2)	±.012 (.305)	±.015 (0.38)
T Max.	.039 (0.10)	.054 (1.37)	.064 (1.63)	.070 (1.78)	.070 (1.78)	.080 (2.03)
Term. (MB) Min. Max.	.004 (.10) .015 (.38)	.010 (.25) .030 (.76)	.010 (.25) .030 (.76)	.010 (.25) .030 (.76)	.010 (.25) .030 (.76)	.010 (.25) .030 (.76)
Min. Cap.	222	103	123	123	473	823
Max. Cap. (code) & WVDC						
10V						
16V	564	225	685	106	106	226
25V	334	105	335	106	565	226
50V	154	684	185	335	475	186
100V	563	224	474	105	185	475
200V	153	563	154	334	564	185

Dimensions shown in inches (mm)
Higher voltages available upon request

Part Number Code

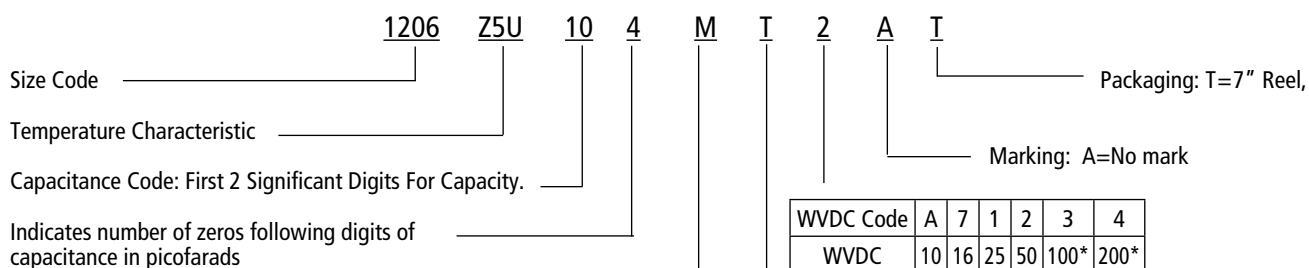

*Special Order - Consult Factory

CAPACITANCE TOLERANCE		
Code	M	Z
Tol.	±20%	+80 -20%



Termination Code

T = Tin plated over Nickel Barrier (Standard), RoHS Compliant
W = Tin/Lead, Solder Plated over Nickel Barrier**

**Consult ATC for availability

A M E R I C A N T E C H N I C A L C E R A M I C S

ATC North America
sales@atceramics.com

ATC Europe
saleseur@atceramics.com

ATC Asia
sales@atceramics-asia.com

www.atceramics.com

DF Exceptions – X7R and X5R Dielectric

Rated WVDC	D.F.	DF Exceptions	
≥ 100 V	≤ 2.5%	≤ 3%	1206 ≥ 0.47 μF
		≤ 5%	0805 ≥ 0.1 μF, 0603 ≥ 0.068 μF, 1206 > 1 μF, 1210 ≥ 2.2 μF
50 V	≤ 2.5%	≤ 3%	0201 (50V), 0603 ≥ 0.047 μF, 0805 > 0.18 μF, 1206 ≥ 0.47 μF
		≤ 5%	1210 ≥ 4.7 μF
		≤ 10%	0402 ≥ 0.1 μF, 0603 > 0.1 μF, 0805 ≥ 1 μF, 1206 ≥ 2.2 μF, 1210 ≥ 10 μF
35 V	≤ 3.5%	≤ 10%	0603 ≥ 1 μF, 0805 ≥ 2.2 μF, 1210 ≥ 10 μF
25 V	≤ 3.5%	≤ 5%	0201 ≥ 0.01 μF, 0805 ≥ 1 μF, 1210 ≥ 10 μF
		≤ 7%	0603 ≥ 0.33 μF, 1206 ≥ 4.7 μF
		≤ 10%	0201 ≥ 0.1 μF, 0402 ≥ 0.10 μF, 0603 ≥ 0.47 μF, 0805 ≥ 2.2 μF, 1206 ≥ 6.8 μF, 1210 ≥ 22 μF
		≤ 12.5%	0402 ≥ 1 μF
16 V	≤ 3.5%	≤ 5%	0201 ≥ 0.01 μF, 0402 ≥ 0.033 μF, 0603 ≥ 0.15 μF, 0805 ≥ 0.68 μF, 1206 ≥ 2.2 μF, 1210 ≥ 4.7 μF
		≤ 10%	0201 ≥ 0.1 μF, 0402 ≥ 0.22 μF, 0603 ≥ 0.68 μF, 0805 ≥ 2.2 μF, 1206 ≥ 4.7 μF, 1210 ≥ 22 μF
10 V	≤ 5%	≤ 10%	0201 ≥ 0.012 μF, 0402 ≥ 0.33 μF (0402/X7R ≥ 0.22 mF), 0603 ≥ 0.33 μF, 0805 ≥ 2.2 μF, 1206 ≥ 4.7 μF, 1210 ≥ 22 μF
		≤ 15%	0201 ≥ 0.1 μF, 0402 ≥ 1 μF
6.3 V	≤ 10%	≤ 15%	0201 ≥ 0.1 μF, 0402 ≥ 1 μF, 0603 ≥ 10 μF, 0805 ≥ 4.7 μF, 1206 ≥ 47 μF, 1210 ≥ 100 μF
		≤ 20%	0402 ≥ 2.2 μF
4 V	≤ 15%	—	—

DF Exceptions – Y5V Dielectric

Rated WVDC	D.F.	DF Exceptions	
≥ 50 V	≤ 5%	≤ 7%	0603 ≥ 0.1 μF, 0805 ≥ 0.47 μF, 1206 ≥ 4.7 μF
35 V	≤ 7%	—	—
25 V	≤ 5%	≤ 7%	0402 ≥ 0.047 μF, 0603 ≥ 0.1 μF, 0805 ≥ 0.33 μF, 1206 ≥ 1 μF, 1210 ≥ 4.7 μF
		≤ 9%	0402 ≥ 0.068 μF, 0603 ≥ 0.47 μF, 1206 ≥ 4.7 μF, 1210 ≥ 22 mF, Cap ≥ 1 μF
16 V (C < 1.0 μF)	≤ 7%	≤ 9%	0402 ≥ 0.068 μF, 0603 ≥ 0.68 μF
		≤ 12.5%	0402 ≥ 0.22 μF
16 V (C ≥ 1.0 μF)	≤ 3.5%	≤ 12.5%	0603 ≥ 2.2 μF, 0805 ≥ 3.3 μF, 1206 ≥ 10 μF, 1210 ≥ 22 μF, 1812 ≥ 47 μF
10 V	≤ 12.5%	≤ 20%	0402 ≥ 0.47 μF
6.3 V	≤ 20%	—	—

ATC GENERAL PURPOSE CAPACITORS:

General Purpose SMT Tape and Reel Packaging Specifications

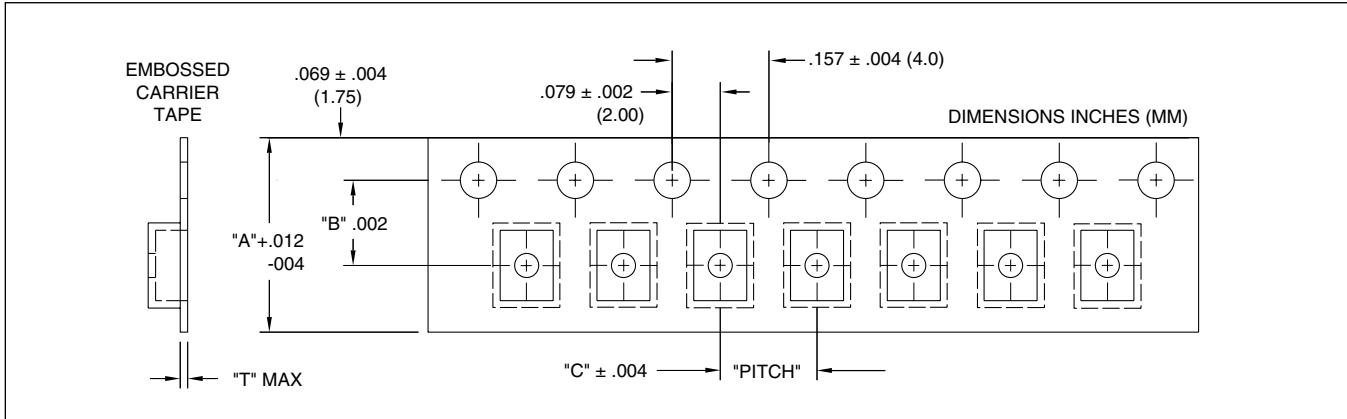

CHIP CASE SIZE	"A" DIM. MAX.	"B" DIM.	"C" DIM.	"T" DIM. MAX.	REEL WIDTH MAX.	QTY. MAX PER REEL TYP.
0402*	.327 (8.30)	.138 (3.50) ±.002 (±0.05)	.157 (4.00) ±.004 (±0.10)	.024 (0.60)	.567 (14.4)	10,000
0603	.327 (8.30)	.138 (3.50) ±.002 (±0.05)	.157 (4.00) ±.004 (±0.10)	.024 (0.60)	.567 (14.4)	4,000
0805	.327 (8.30)	.138 (3.50) ±.002 (±0.05)	.157 (4.00) ±.004 (±0.10)	.024 (0.60)	.567 (14.4)	4,000
1206	.327 (8.30)	.138 (3.50) ±.002 (±0.05)	.157 (4.00) ±.004 (±0.10)	.024 (0.60)	.567 (14.4)	4,000
1210	.327 (8.30)	.138 (3.50) ±.002 (±0.05)	.157 (4.00) ±.004 (±0.10)	.024 (0.60)	.567 (14.4)	2,000 to 4,000
1812	.484 (12.3)	.217 (5.50) ±.002 (±0.05)	.157 (4.00) ±.004 (±0.10)	.024 (0.60)	.724 (18.4)	1,000
2225	.484 (12.3)	.217 (5.50) ±.002 (±0.05)	.157 (4.00) ±.004 (±0.10)	.024 (0.60)	.724 (18.4)	1,000

*0402 uses paper carrier tape; all other sizes use embossed carrier tape

inches (mm)

NOTE: Reel size is 7.0 (177.8)

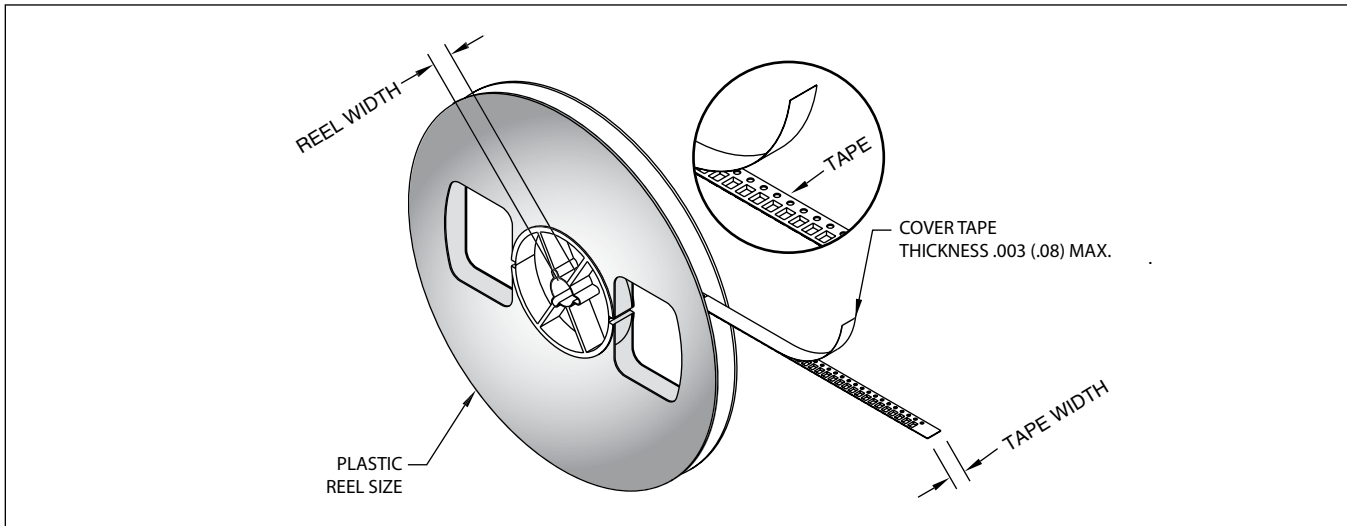

NOTE: Part orientation is horizontal for all chip case sizes.

A M E R I C A N T E C H N I C A L C E R A M I C S

ATC North America
sales@atceramics.com

ATC Europe
saleseur@atceramics.com

ATC Asia
sales@atceramics-asia.com

www.atceramics.com

Sales of ATC products are subject to the terms and conditions contained in American Technical Ceramics Corp. Terms and Conditions of Sale (ATC document #001-992). Copies of these terms and conditions will be provided upon request. They may also be viewed on ATC's website at www.atceramics.com/productfinder/default.asp. Click on the link for Terms and Conditions of Sale.

ATC has made every effort to have this information as accurate as possible. However, no responsibility is assumed by ATC for its use, nor for any infringements of rights of third parties which may result from its use. ATC reserves the right to revise the content or modify its product without prior notice.

© 1997 American Technical Ceramics. All Rights Reserved.

ATC 001-847 Rev. Y; 4/18



AMERICAN

ATC North America
sales@atceramics.com

TECHNICAL

ATC Europe
saleseur@atceramics.com

CERAMICS

ATC Asia
sales@atceramics-asia.com



THE ENGINEERS' CHOICE™

www.atceramics.com